

# SIMPLER SMARTER THAN EVER



— Classia —







# Classia

---

- 4 **SIMPLE** SHAPE
- 8 **SIMPLE** CHOICE
- 10 **SMART** SOLUTION
- 14 **SMART** ELECTRICAL SYSTEM
- 24 CATALOGUE

# SIMPLE SHAPE



A modern pure shape, defined by an accurate outline which contrasts with a gently curved surface. The frame gives a unique touch to your switch.





Two finishes of shiny white and black satin devices

Frame from tone to tone effects to metal gold, chrome, nickel



A modern pure shape,  
defined by an accurate  
outline contrasts  
with a gently curved volume

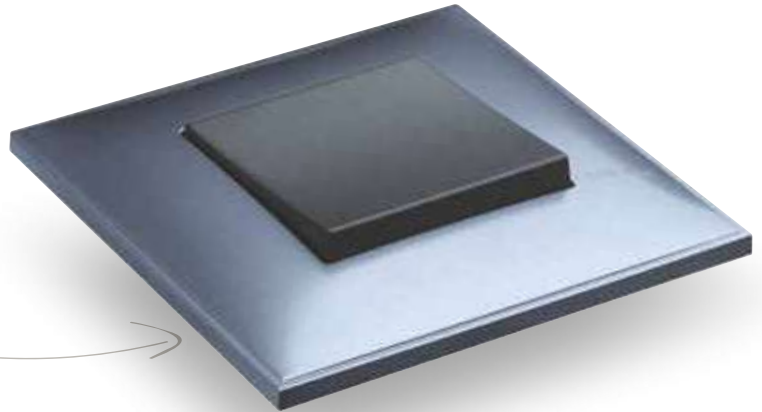

Slightly curved  
push button



**SWITCH: 2 DIFFERENT VERSION**  
**Not lightable:** always uniform aesthetic  
**Lightable with led included:** advantage  
to have a clear, intense bright beam



16 plate finishes to match with  
2 different colors of controls:  
white glossy - black satin.  
The richness grows with  
the richness of frame from tone  
to tone effects to metal gold,  
chrome, nickel.

# SIMPLE



# CHOICE



**BASICS**



**FRAMES**



**FINISHES**



**ACCENTS**



A unique and complete offer with all the modular systems: Italian and European standard.

# SMART SOLUTION



**TWO MODULES**  
European standard

**THREE MODULES**  
Italian standard

# ALL POSSIBLE COMBINATIONS

6 For European installation system - up to 5 gangs

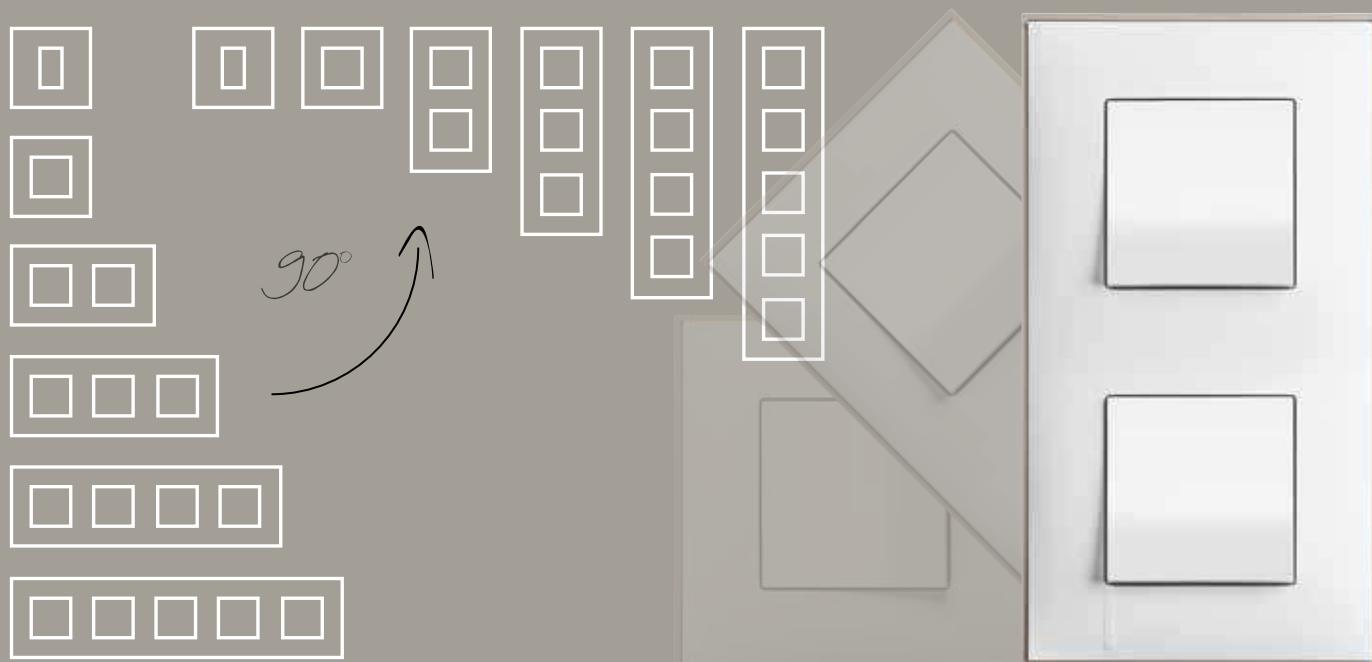

5 For Italian installation system





# SMART INSTALLATION



## INSTALLATION SYSTEM

- Innovative cover plates regulation system guarantee plate flush on the wall
- Easy installation and removal of devices

### Screw fixing support

**PLASTERBOARD INSTALLATION:**

- Frame to be removed on plasterboard wall to guarantee the perfect alignment of cover plates and switches flush on the wall.

**METAL INSERT:**

- It makes the support rigid.
- The metal eyelets guarantee a better fixing of the screws.

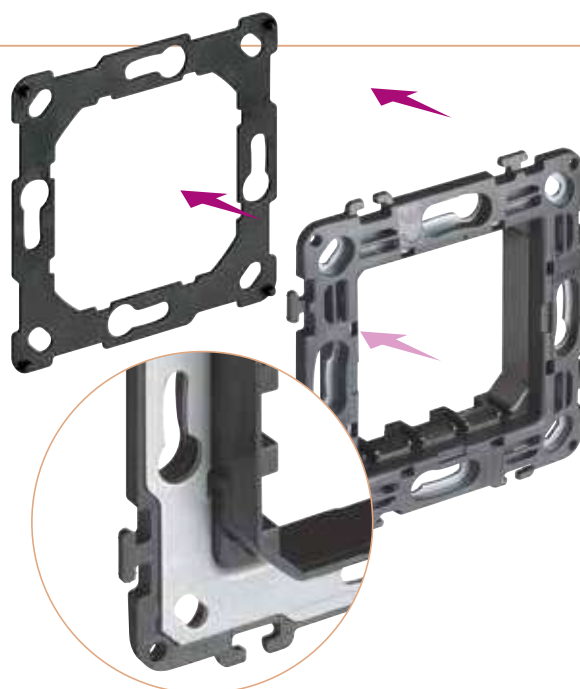

### Support with clips

Fixing clips

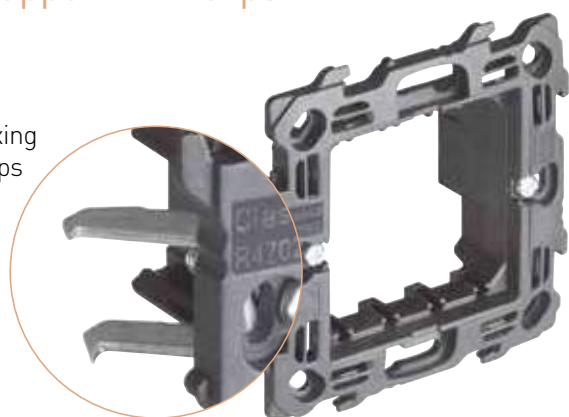

**Innovative docking system for multiple installations.**

If needs you can remove the clips and install the support with the screw.

Perfect alignment due to a self-supporting hooking system.  
High resistance due to special material

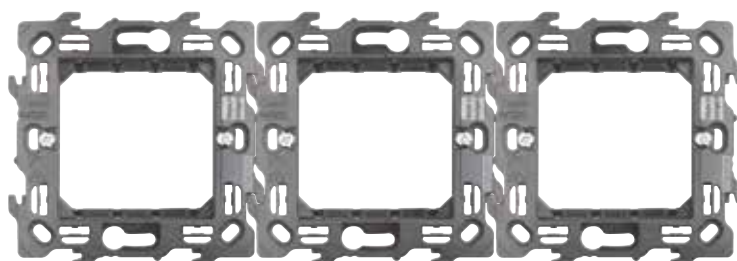



# SMART ELECTRICAL SYSTEM



Classia with Netatmo forms part of Eliot, the BTicino program for connected objects.

# Classia

WITH  
Netatmo

## From traditional to Smart



### AN IDEAL EVOLUTION FOR:

- Turning existing traditional systems into Smart systems with only a few wiring interventions;
- Creating new Smart systems for the control of lights, shutters and consumptions, and to prevent overload black-out;
- All this without changing your working habits.



Home + Control

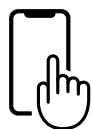

REMOTE CONTROL



CREATION OF SCENARIOS



VOICE CONTROL

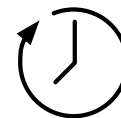

PLANNING PROGRAMMED



# Classia

WITH  
Netatmo

# Smart electrical system

Monitoring the home  
is even easier.

A single Home+Control App to manage lights, shutter, energy and temperature. The function may also be easily monitored using voice controls sent through the Apple Siri, Google Home and Amazon Alexa voice assistants.



App  
Home + Control

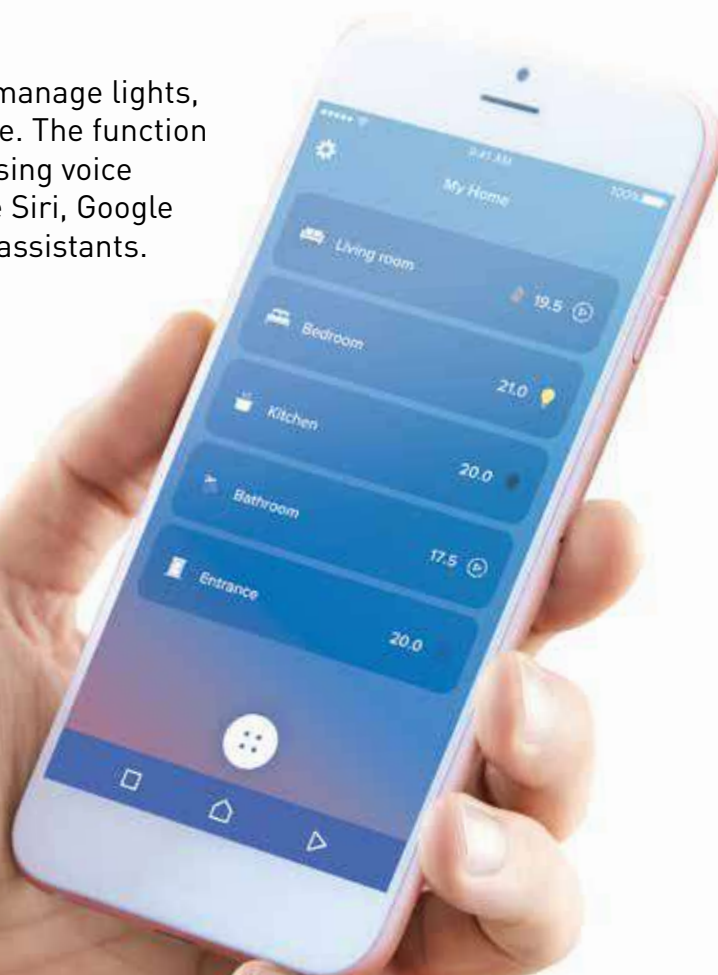

**GENERAL CONTROL**

With one single click, a general control will allow you to switch off all the lights and lower all the shutters when you leave your home, or to activate your favourite scenario.



**CONTROL WITH SMARTPHONE**

From your smartphone, you will be able to view and check the status of lights, shutters and connected power sockets from anywhere.



**VOICE COMMAND**

You can control your system with your voice thanks to your favourite voice assistant.



**PLANNED PROGRAMMING**

Program the activation of lights, shutters and loads connected to sockets based on your needs. Some examples:

- automatically switch on the garden lights at sunset and switch them off at sunrise;
- switch on some lights and activate some shutters to simulate the presence of someone in the house when on holidays.

# Classia

WITH  
Netatmo

## Smart electrical system

### MANAGEMENT OF THE TEMPERATURE

Remotely check and manage the temperature inside your home using your smartphone and installing the connected thermostat Smarter with NETATMO.

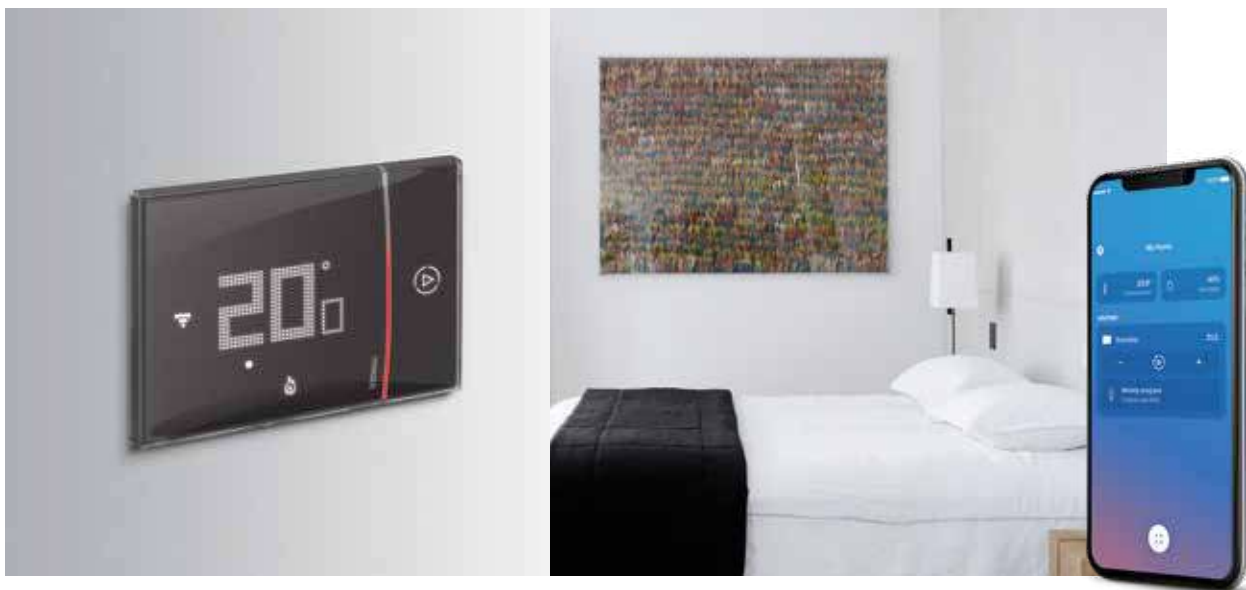

### LIGHTING AT THE DESIRED LEVEL

Adjust the light level for optimum personal comfort. You can do that from the connected Dimmer, the associated wireless controls and the Smartphone, using the Home+Control App.

**LOAD CONTROL TO AVOID BLACKOUTS (\*)**

In overload conditions, the system automatically disconnects the least important load to avoid tripping of the meter (blackout).

**ENERGY CONSUMPTION CONTROL**

Use your smartphone to check the electricity consumption of your appliances (daily, monthly and yearly).

**WIRELESS CONTROL**

You can add wireless controls (lights, shutters and sockets), or reposition them at any time depending on your needs.

**ALARM NOTIFICATIONS**

You can receive warning notifications on your smartphone.

Note (\*): functions available by Autumn 2020.

# Classia

WITH  
Netatmo

## Home + Control



one single App,  
many connected advantages

Home+Control is the App that makes it simple to supervise all the Classia Smart system functions using iOS and Android mobile devices, inside and outside the home.

The Homepage shows all the system information.



### WHAT YOUR CUSTOMER CAN DO:

1. Activate and customise **8 scenarios** (4 preconfigured scenarios, coming in, going out, day, night and 4 scenarios customisable by the user);
2. **Display and check the status of lights, shutters, loads connected to sockets and the room temperature;**
3. **Use the Smarter timer thermostat** simply and intuitively;
4. **Check the total home consumptions.**
5. **Receive notifications** on the load and system status;
6. **Define the load priority** for black-out prevention (function available by Autumn 2020).



## HOME + CONTROL CONFIGURATION IS EASY, BOTH FOR YOU AND YOUR CUSTOMER.

You simply have to download the App from the Apple or Google store, and follow the guided procedure.

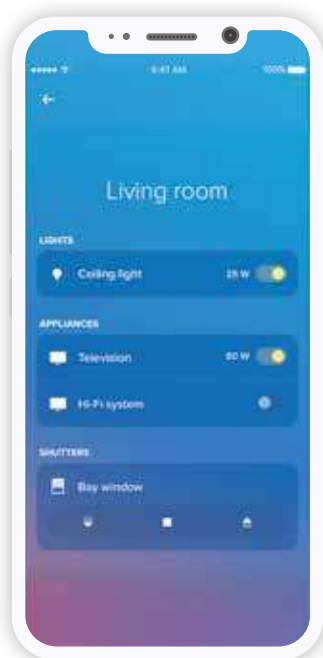

Lights, shutters  
and generic loads activations



Consumption  
display

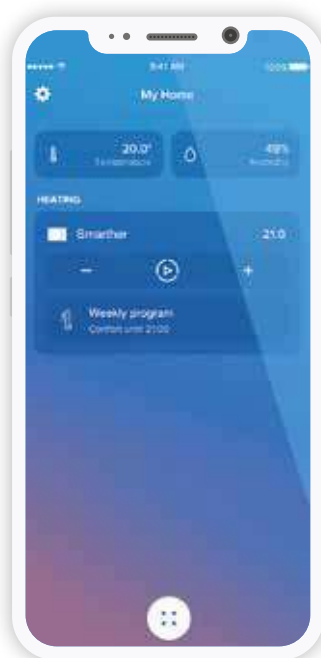

Management of the  
temperature

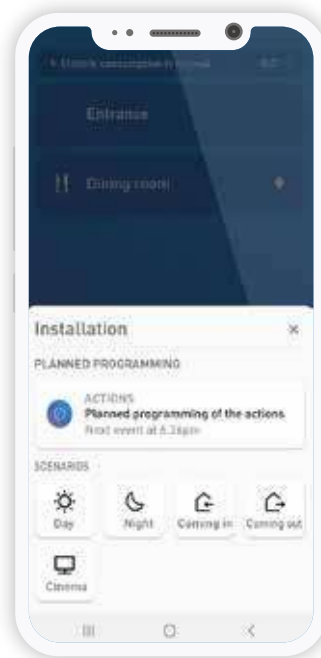

Scenario  
management

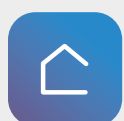

### INTEGRATION WITH IFTTT

The Classia Smart functions can be extended thanks to the integration with the IFTTT platform. It will be possible to create automated actions based on events generated in the electric system, or by external services and connected third-party devices.

# Classia

WITH  
Netatmo

# Manage the home also with the voice

Use the Apple,  
Google and Amazon  
voice assistants.

Using their preferred voice assistants,  
your customers can control their homes  
hands-free: an extremely useful function  
also for those with mobility problems.

«Ehi Siri,  
close all the  
shutters»



HomeKit is a registered trade mark which is the property of Apple Inc. Google Home is a registered trade mark which is the property of Google LLC, Amazon Alexa is a registered trade mark which is the property of Amazon.com, Inc.

Note: Home Pod, Google Home and Amazon Echo are available from Apple store, Google Store, Amazon, or from authorised retailers.



# Wireless Controls

## WALL MOUNTED INSTALLATION

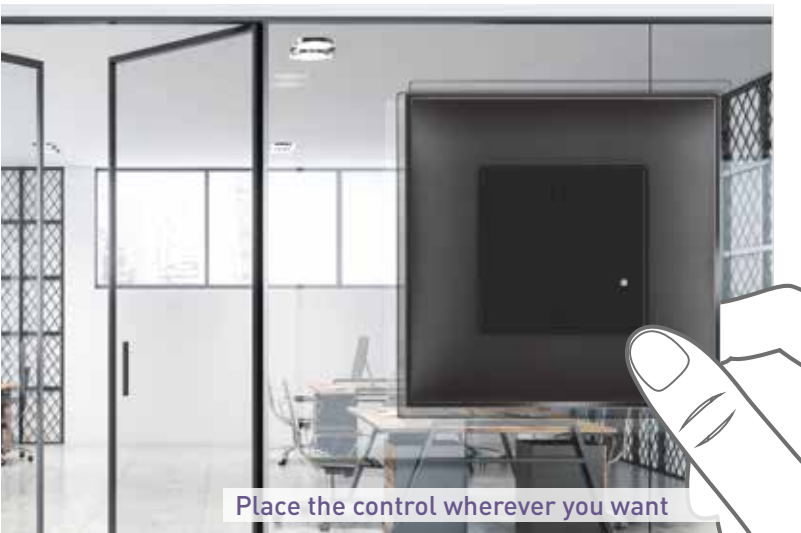

Place the control wherever you want



Add a control in an unexpected place



### IT CAN BE INSTALLED IN A FEW SECONDS

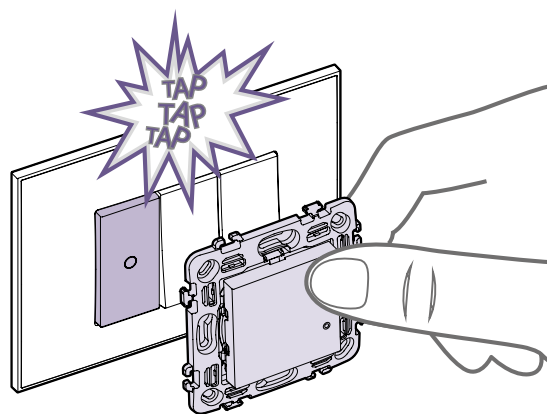

1. associate the control with a simple action

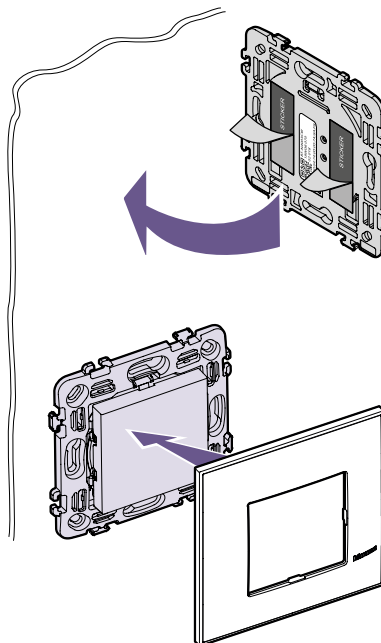

2. install the control using the supplied double-sided tape

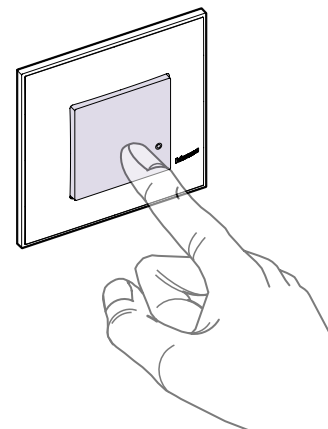

3. the control is ready to be used

### POWER SUPPLY WITH LONG-LIFE BATTERIES

The control is powered by a CR2032 battery, capable of guaranteeing operation for 8 years.

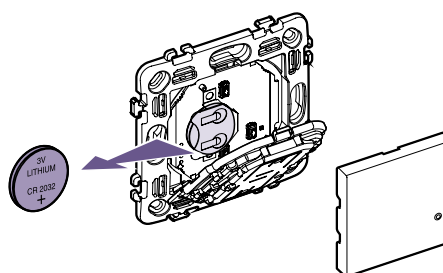

# CLASSIA

## Switches

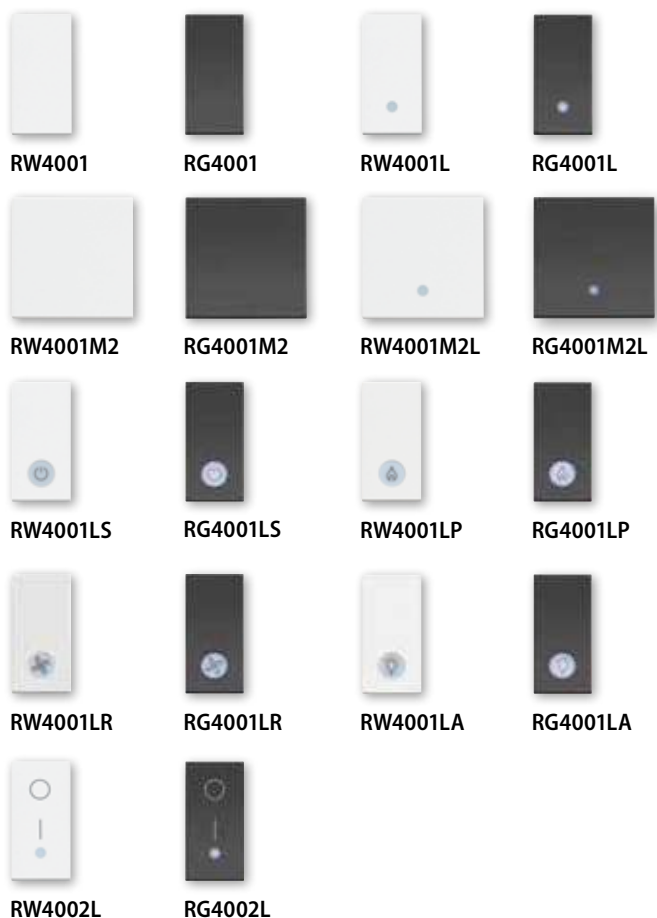

Item	ONE-WAY SWITCHES
<input type="checkbox"/> RW4001	1P 10 AX - 250 Va.c. - 1 module - white
<input checked="" type="checkbox"/> RG4001	as above - black
<input type="checkbox"/> RW4001L	1P 10 AX - 250 Va.c. - lightable with led lamp 230 V included - 1 module - white
<input checked="" type="checkbox"/> RG4001L	as above - black
<input type="checkbox"/> RW4001M2	1P 10 AX - 250 Va.c. - 2 modules - white
<input checked="" type="checkbox"/> RG4001M2	as above - black
<input type="checkbox"/> RW4001M2L	1P 10 AX - 250 Va.c. - lightable with led lamp 230 V included - 2 modules - white
<input checked="" type="checkbox"/> RG4001M2L	as above - black
<input type="checkbox"/> RW4001LS	1P 16 AX - 250 Va.c. - lightable with led lamp 230 V included - 1 module - boiler symbol - white
<input checked="" type="checkbox"/> RG4001LS	as above - black
<input type="checkbox"/> RW4001LP	1P 16 AX - 250 Va.c. - lightable with led lamp 230 V included - 1 module - heater symbol - white
<input checked="" type="checkbox"/> RG4001LP	as above - black
<input type="checkbox"/> RW4001LR	1P 10 AX - 250 Va.c. - lightable with led lamp 230 V included - 1 module - fan symbol - white
<input checked="" type="checkbox"/> RG4001LR	as above - black
<input type="checkbox"/> RW4001LA	1P 10 AX - 250 Va.c. - lightable with led lamp 230 V included - 1 module - lamp symbol - white
<input checked="" type="checkbox"/> RG4001LA	as above - black
<input type="checkbox"/> RW4002L	2P 16 AX - 250 Va.c. - lightable with led lamp 230 V included - 1 module - white
<input checked="" type="checkbox"/> RG4002L	as above - black

Item	TWO-WAY SWITCHES
<input type="checkbox"/> RW4003	1P 10 AX - 250 Va.c. - 1 module - white
<input checked="" type="checkbox"/> RG4003	as above - black
<input type="checkbox"/> RW4003L	1P 10 AX - 250 Va.c. - lightable with led lamp 230 V included - 1 module - white
<input checked="" type="checkbox"/> RG4003L	as above - black
<input type="checkbox"/> RW4003M2	1P 10 AX - 250 Va.c. - 2 modules - white
<input checked="" type="checkbox"/> RG4003M2	as above - black
<input type="checkbox"/> RW4003M2L	1P 10 AX - 250 Va.c. - lightable with led lamp 230 V included - 2 modules - white
<input checked="" type="checkbox"/> RG4003M2L	as above - black

Item	FOUR-WAY SWITCHES
<input type="checkbox"/> RW4004	intermediate switch 10 AX - 250 Va.c. - 1 module - white
<input checked="" type="checkbox"/> RG4004	as above - black
<input type="checkbox"/> RW4004L	intermediate switch 10 AX - 250 Va.c. - lightable with led lamp 230 V included - 1 module - white
<input checked="" type="checkbox"/> RG4004L	as above - black
<input type="checkbox"/> RW4004M2	intermediate switch 10 AX - 250 Va.c. - 2 modules - white
<input checked="" type="checkbox"/> RG4004M2	as above - black
<input type="checkbox"/> RW4004M2L	intermediate switch 10 AX - 250 Va.c. - lightable with led lamp 230 V included - 2 modules - white
<input checked="" type="checkbox"/> RG4004M2L	as above - black

# CLASSIA

## Switches



RW4005 RG4005 RW4005L RG4005L



RW4005M2 RG4005M2 RW4005M2L RG4005M2L



RW4042V230 RG4042V230 RW4042V12 RG4042V12



RW4042M2 RG4042M2



RW4043 RG4043 R4040



RW4915M2 RG4915M2



RW4001B3 RW4001B4



RW4431 RG4431



RW4037 RG4037 RW4027 RG4027

Item	PUSHBUTTONS
<input type="checkbox"/> RW4005	1P (NO) 10 A - 250 Va.c. - 1 module - white
<input checked="" type="checkbox"/> RG4005	1P (NO) 10 A - 250 Va.c. - 1 module - black
<input type="checkbox"/> RW4005L	1P (NO) 10 A - 250 Va.c. - lightable with led lamp 230 V included - 1 module - white
<input checked="" type="checkbox"/> RG4005L	as above - black
<input type="checkbox"/> RW4005M2	1P (NO) 10 A - 250 Va.c. - 2 modules - white
<input checked="" type="checkbox"/> RG4005M2	as above - black
<input type="checkbox"/> RW4005M2L	1P (NO) 10 A - 250 Va.c. - lightable with led lamp 230 V included - 2 modules - white
<input checked="" type="checkbox"/> RG4005M2L	as above - black
<input type="checkbox"/> RW4042V230	1P (NO) 10 A - 250 Va.c. - bell symbol - lightable with led lamp 230 V included - 1 module - white
<input checked="" type="checkbox"/> RG4042V230	as above - black
<input type="checkbox"/> RW4042V12	1P (NO) 10 A - 250 Va.c. - bell symbol - lightable with led lamp 12/24 V included - 1 module - white
<input checked="" type="checkbox"/> RG4042V12	as above - black
<input type="checkbox"/> RW4042M2	1P (NO) 10 A - 250 Va.c. - bell symbol - lightable with led lamp 12/24 V (not included) - 2 module - white
<input checked="" type="checkbox"/> RG4042M2	as above - black
<input type="checkbox"/> RW4043	pushbutton 1P (NO) 10A - 250 Va.c. lamp symbol - lightable with led lamp 230 V included - white
<input checked="" type="checkbox"/> RG4043	as above - black
<input type="checkbox"/> R4040	pushbutton 1P (NO) 10A with nameplate lightable with led lamp (not included) - 2 modules
<input type="checkbox"/> LN4742V230T	lamp with led for light signalling 230 Va.c. - white
<input type="checkbox"/> LN4742V12T	lamp with led for light signalling 12/24 Va.c. - white

KEY COVERS	
<input type="checkbox"/> RW4915M2	2 modules - white
<input checked="" type="checkbox"/> RG4915M2	2 modules - black

OTHER SWITCHES	
<input type="checkbox"/> RW4001B3	bathroom switch with indication for three independent circuits 10/2x16 AX 250 Va.c. (light, heater, boiler)
<input type="checkbox"/> RW4001B4	bathroom switch with indication for four independent circuits 2x10/2x16 AX 250 Va.c. (light, fan, heater, boiler)

PASSIVE INFRARED SWITCHES	
<input type="checkbox"/> RW4431	switch with passive infrared motion sensor suitable for all types of load including LED lamps - 3 wires - twilight circuit with variable threshold with the possibility of exclusion - timing circuit for delayed switch-off adjustable from 30 seconds to 10 minutes - 230 Va.c. power supply - 1 module - white
<input checked="" type="checkbox"/> RG4431	as above - black

SHUTTER SWITCHES	
<input type="checkbox"/> RW4037	double 1P (NO) + 1P (NO) 10A - 250Va.c. interlocked - 1 module - white
<input checked="" type="checkbox"/> RG4037	as above - black
<input type="checkbox"/> RW4027	changeover switch 1P 10 A - 250 Va.c. - 1 module - white
<input checked="" type="checkbox"/> RG4027	as above - black

# CLASSIA

## Dimmers



RW4402



RG4402



RW4411



RG4411

### DIMMER

<input type="checkbox"/> RW4402	rotary dimmer 40 - 400 W 230 Va.c. - 2 modules - white
<input checked="" type="checkbox"/> RG4402	as above - black
<input type="checkbox"/> RW4411	universal dimmer (resistive – inductive, capacitive, fluorescent compact and dimmer LEDs) - 150/200/400 W with electronic protection - 2 modules - white
<input checked="" type="checkbox"/> RG4411	as above - black

### Loads

Item	Type	Range (Va.c.)	Supply std					
				Incandescents and halogens	Halogens with ferromagnetic transformer	Halogens with electronic transformer	Dimmerable compact fluorescents	Dimmerable LED lamps
RW4402 RG4402	Resistive	230 50	230 Va.c.	40 ÷ 400 W				
RW4411 RG4411	Universal	100 ÷ 240 50 ÷ 60	230 Va.c. 100 Va.c.	3 ÷ 200 W 3 ÷ 400 W	3 ÷ 200 VA 3 ÷ 400 VA	3 ÷ 200 VA 3 ÷ 400 VA	3 ÷ 75 W 3 ÷ 150 W	3 ÷ 75 W 3 ÷ 150 W

## Socket outlets



RW4141



RG4141



R4141A



R4141R



R4141V



RW4141C



RG4141C

### Item

### GERMAN STANDARD

<input type="checkbox"/> RW4141	socket 2P+E 16A 250 Va.c. - socket with earth side contacts - shielded tulip contacts - white
<input checked="" type="checkbox"/> RG4141	as above - black
<input type="checkbox"/> R4141A	as above - orange
<input type="checkbox"/> R4141R	as above - red
<input type="checkbox"/> R4141V	as above - green
<input type="checkbox"/> RW4141C	socket 2P+E 16A 250 Va.c. - socket with earth side contacts - shielded tulip contacts, with IP20 flap - white
<input checked="" type="checkbox"/> RG4141C	as above - black

# CLASSIA

## Socket outlets

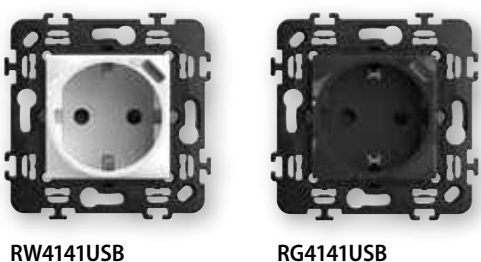

### ITALIAN STANDARD

<input type="checkbox"/> RW4180	2P+E 16 A 250 Va.c. socket - center distance 19 mm and 26 mm - shielded tulip contacts - for plugs 2 P and 2 P+E 10 and 16 A Italian standard - white
■ RG4180	as above - black
○ R4180R	as above - red
<input type="checkbox"/> RW4113	socket 2P+E 10A 250 Va.c. -type earth side contacts - shielded socket contacts - white
■ RG4113	as above - black
<input type="checkbox"/> RW4140A16	socket 2P+E 10A and 16A 250 Va.c. 19 mm and 26 mm center distance, 2-center socket configuration protected socket contacts; earth side contacts for German standard plugs; suitable for Italian standard plugs 2P and 2P+E 10/16A, German standard plugs 2P+E 16A - white
■ RG4140A16	as above - black
○ R4140A16R	as above - red

### EURO-AMERICAN STANDARD

<input type="checkbox"/> RW4125	socket 2P 16 A 127/250 Va.c. - shielded holes - white
■ RG4125	as above - black

### ISRAELI STANDARD

<input type="checkbox"/> RW4183	socket 2P+E 16 A 250 Va.c. - white
■ RG4183	as above - black
○ R4183R	as above - red

### USB CHARGER

<input type="checkbox"/> RW4287C2	5 Vdc USB charger TYPE A and C for quick charge of one single electronic device (mobile phones, smartphones, tablets or similar) up to 3000 mA or simultaneous charging of two devices up to 1500 mA- 110÷230 Va.c. 50÷60 Hz power supply - 2 modules - white
■ RG4287C2	as above - black
<input type="checkbox"/> RW4286C2	5 Vdc USB charger TYPE C for quick charge of one single electronic device (mobile phones, smartphones, tablets or similar) up to 3000 mA or simultaneous charging of two devices up to 1500 mA- 110÷230 Va.c. 50÷60 Hz power supply - 2 modules- white
■ RG4286C2	as above - black

### USB SOCKETS

<input type="checkbox"/> RW4141USB	German standard electric socket with integrated USB charger. Socket 2 P+E 16 A 250 VA - protected tulip contacts - side earth contact. 5 Vdc type C USB charger for charging electronic devices up to 1,500 mA. 2 modules - white
■ RG4141USB	as above - black

# CLASSIA

## TV sockets



### TV SOCKETS

<input type="checkbox"/> RW4202D	star coaxial socket for single-user aerial systems, also remote powered and centralised, and single-user / centralised satellite systems with current and signal transfer for channels selection; shielded connection clamps with captive screws - Ø 9.5 mm; male connector - 1 module - white
<input checked="" type="checkbox"/> RG4202D	as above - black
<input type="checkbox"/> RW4202P10	terminal coaxial socket, -10dB attenuation, for centralised TV systems, also remote powered, and centralised satellite systems with current and signal transfer for channels selection; shielded connection clamps with captive screws - Ø 9,5 mm - male connector - incorporated impedance final adapter 75 Ω - 1 module - white
<input checked="" type="checkbox"/> RG4202P10	as above - black
<input type="checkbox"/> RW4202P14	passthrough coaxial socket, -14dB attenuation, for centralised TV systems, also remote powered, and centralised satellite systems with current and signal transfer for channels selection - shielded connection clamps with captive screws - Ø 9.5 mm; male connector - 1 module - white
<input checked="" type="checkbox"/> RG4202P14	as above - black
<input type="checkbox"/> RW4217M2D	star demixed coaxial socket for single-user aerial systems, also remote powered and shunting centralized, and for single-user / shunting centralized satellite systems with current and signal transfer for channels selection; Ø 9.5 mm; male connector - type F SAT connector - 2 modules - white
<input checked="" type="checkbox"/> RG4217M2D	as above - black
<input type="checkbox"/> RW4217M2P10	terminal demixed coaxial socket, -10dB attenuation, for centralized TV systems, also remote powered, and centralized satellite systems with current and signal transfer for channels selection; Ø 9.5 mm; male connector - type F SAT connector - incorporated impedance final adapter 75 Ω - 2 modules - white
<input checked="" type="checkbox"/> RG4217M2P10	as above - black
<input type="checkbox"/> RW4217M2P14	passthrough demixed coaxial socket, -14dB attenuation, for centralized TV systems, also remote powered, and centralized satellite systems with current and signal transfer for channels selection; Ø 9.5 mm; male connector - type F SAT connector - 2 modules - white
<input checked="" type="checkbox"/> RG4217M2P14	as above - black
<input type="checkbox"/> RW4210M2D	star demixed coaxial socket for single-user aerial systems, also remote powered and shunting centralised, and for single-user/shunting centralised satellite systems with current and signal transfer for channels selection, and for radio systems; Ø 9.5 mm male TV connector - type F SAT connector and female radio Ø 9.5 mm - 2 modules - white
<input checked="" type="checkbox"/> RG4210M2D	as above - black
<input type="checkbox"/> RW4202F	type-F coaxial socket - impedance 75 ohm - screw hook - 1 module - white
<input checked="" type="checkbox"/> RG4202F	as above - black

# CLASSIA

## Telephone and data sockets



Item	RJ CONNECTORS
<input type="checkbox"/> RW4258RJ11	RJ11 connector type K10 - 1 module - white
<input checked="" type="checkbox"/> RG4258RJ11	as above - black
<input type="checkbox"/> RW4238	telephone socket - ISRAELI standard - 1 module - white
<input checked="" type="checkbox"/> RG4238	as above - black
<input type="checkbox"/> RW4279C5E	RJ45 toolless UTP cat5E - 1 module - white
<input checked="" type="checkbox"/> RG4279C5E	as above - black
<input type="checkbox"/> RW4279C6	RJ45 toolless UTP cat6 - 1 module - white
<input checked="" type="checkbox"/> RG4279C6	as above - black
<input type="checkbox"/> RW4279C6S	RJ45 toolless STP cat6 - 1 module - white
<input checked="" type="checkbox"/> RG4279C6S	as above - black
<input type="checkbox"/> RW4279C6AS	RJ45 toolless STP cat6A - 1 module - white
<input checked="" type="checkbox"/> RG4279C6AS	as above - black

## Optical and acoustic signalling



Item	BELLS AND BUZZERS
<input type="checkbox"/> RW4351V230	bronze bell 230 Va.c. 8 VA - 1 module - white
<input checked="" type="checkbox"/> RG4351V230	as above - black
<input type="checkbox"/> RW4356V230	buzzer 230 Va.c. 8 VA - 1 module - white
<input checked="" type="checkbox"/> RG4356V230	as above - black



Item	REMOVABLE LED LAMP
<input type="checkbox"/> R4380	It automatically turns on in the case of power failure. Push & Pull extracting system - high efficiency white LED - ON / OFF switch and SPOT button to increase light intensity if needed - interchangeable Ni-MH batteries with 2h duration - low consumption in stand-by 0,4W - 127 / 230V power supply. Recharging base, 2 modules - cover included.
<input type="checkbox"/> 4380NB	spare battery for removable led lamp R4380

## Blanking modules



Item	BLANKING MODULES AND OUTPUTS
<input type="checkbox"/> RW4950	blank plate - 1 module - white
<input checked="" type="checkbox"/> RG4950	as above - black
<input type="checkbox"/> RW4953	simple output ø 9.5 mm - 1 module - white
<input checked="" type="checkbox"/> RG4953	as above - black

# CLASSIA

## Hotel offer



RW4033



RG4033



RW4028H



RG4028H



RW4373H



RG4373H



RW4139



RG4139



RW4177



RG4177



RW4549



RG4549



RW4441



RG4441

Item

### PULL-CORD PUSHBUTTON

<input type="checkbox"/> RW4033	1 P (NO) 10 A - 250 Va.c. with cord-pull - 1 module - white
<input checked="" type="checkbox"/> RG4033	as above - black

### MAKE UP THE ROOM / DO NO DISTURB

<input type="checkbox"/> RW4028H	1P 10 A – 250 Vac double-key changeover switch 1-0-2 with interlock and double signalling: "do not disturb" and "make up the room". 1 module - white
<input checked="" type="checkbox"/> RG4028H	as above - black
<input type="checkbox"/> RW4373H	lampholder with double optical signalling: "do not disturb" and "rearrange the room" - 1 module - white
<input checked="" type="checkbox"/> RG4373H	as above - black

### MULTISTANDARD SOCKETS

<input type="checkbox"/> RW4139	socket 2P+E 5/6/10/13 A 250 Va.c. and 127 Va.c. multistandard - 5 A and 13 A = BS std; 6 A = Indian std., 10 A = European std. - white
<input checked="" type="checkbox"/> RG4139	as above - black

### SHAVER SOCKETS

<input type="checkbox"/> RW4177	shaver socket 230V - white
<input checked="" type="checkbox"/> RG4177	as above - black

### KEY FOB SWITCH

<input type="checkbox"/> RW4549	key fob switch to switch ON lights and devices in hotel rooms - slot light with built-in lamp - switch-off delay - max. load 30 VA 230 Vac - 2 modules - white
<input checked="" type="checkbox"/> RG4549	as above - black

### ROOM TEMPERATURE CONTROL

<input type="checkbox"/> RW4441	electronic room thermostat – relay output with 1 contact in switch ing 8 A 250 Va.c. - 230 Va.c. power supply – 50 and 60 Hz - 2 module - white
<input checked="" type="checkbox"/> RG4441	as above - black

## CLASSIA

### IP55 waterproof covers

DESCRIPTION

2 modules

**27602**

DESCRIPTION

3 modules

**27603**

DESCRIPTION

4 modules

**27604**

### IP40 wall-mounting enclosures

DESCRIPTION

1 module

**27401**

DESCRIPTION

2 modules

**27402**

DESCRIPTION

3 modules

**27403**

4 modules

**27404**

### IP55 wall-mounting enclosures

DESCRIPTION

1 module

**27501**

DESCRIPTION

2 modules

**27502**

DESCRIPTION

3 modules

**27503**

4 modules

**27504**

## Smart electrical system

A simple, rational range of connected devices, both wired and wireless.

### REMOTE CONNECTION

#### CONNECTED DEVICES (230V A.C.)



+



**Item RW/RG4501C**  
Gateway with german standard socket and Home/Away wireless switch



**Item FC80GT**  
Gateway DIN

### SCENARIOS

#### BATTERY WIRELESS CONTROLS

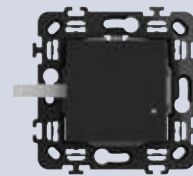

**Item RW/RG4570CW**  
Home/Away wireless switch

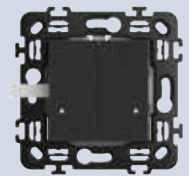

**Item RW/RG4575CW**  
4 scenarios control

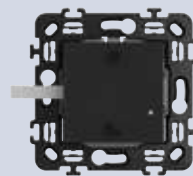

**Item RW/RG4574CW**  
Night&Day scenario control

LIGHTS



**Item RW/RG4411CM2**  
Connected switch/  
dimmer without neutral

**Item RW/RG4412CM2**  
Connected switch/  
dimmer with neutral

SHUTTERS



**Item RW/RG4027CM2**  
Connected  
shutter switch



**Item 4027C**  
Connected  
micromodule  
for shutter

ENERGY AND CONSUMPTION MANAGEMENT



**Item RW/RG4141AC**  
Connected german  
standard socket



**Item FC80RC**  
Connected  
DIN relay  
16 A



**Item 3584C**  
Connected  
light relay  
1,3 A



**Item F20T60A** Smart  
DIN meter  
**Item FC80GCS** Connected  
DIN load management



**Item FC80CC**  
Connected DIN  
contactor 20 A

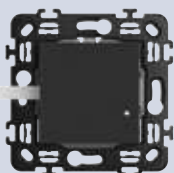

**Item RW/RG4003CW**  
Light control



**Item 3585C**  
Motion sensor



**Item RW/RG4003DCW**  
Double light control



**Item 3577C**  
Wireless module for  
mechanical switch



**Item RW/RG4027CW**  
Shutter control



**Item 4141PC**  
Mobile german standard  
power outlet

Connected  
thermostat  
**Item XW8002**  
**Item XW8002W**  
**Item XG8002**



Note: The devices are also available in white.

Turn a traditional system into a Smart system with just a few simple steps.

**1. Install the gateway in the switchboard, or flush mounted in a desired position**

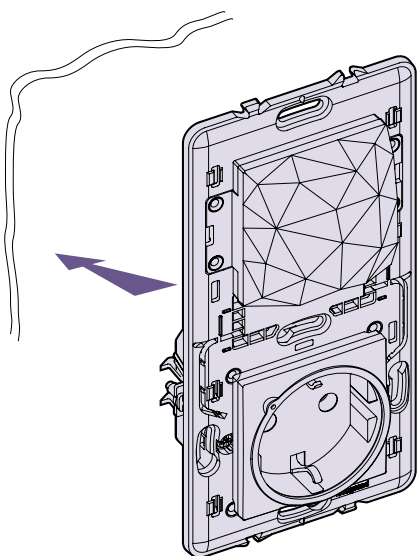

Flush mounted gateway with socket.  
Ensure appropriate home Wi-Fi signal.

**2. Replace current devices with the connected devices for your type of system**

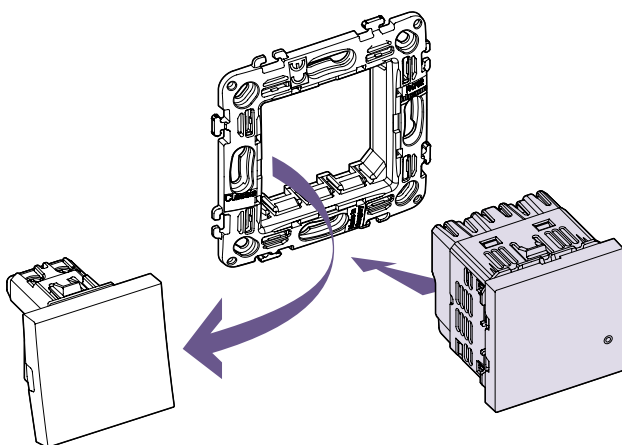

In place of a traditional device, install the connected device of the corresponding type for the managing of lights, shutters and sockets: one for each control line.

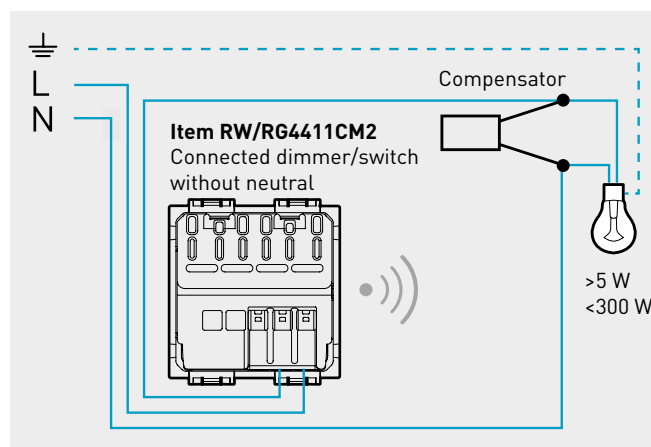

Example of connected dimmer/switch wiring

### 3. Add the energy meter module if desired

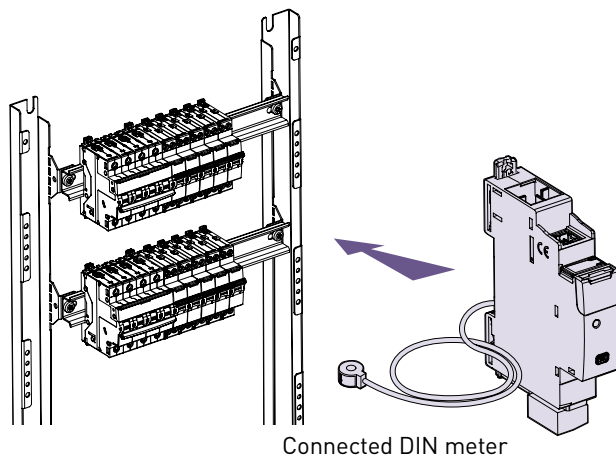

Connected DIN meter

### 4. Devices can be associated to each other by simply pressing a pushbutton

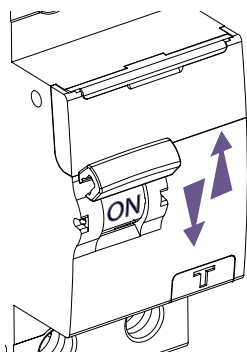

Switch the system off and on.

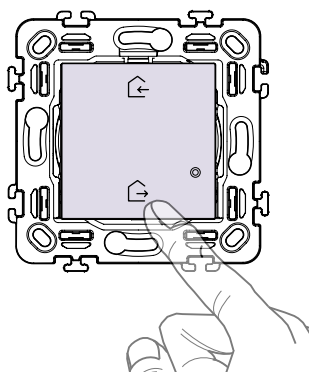

Press the Home/Away master scenario control supplied with the gateway for 5 seconds. Devices are associated to each other.

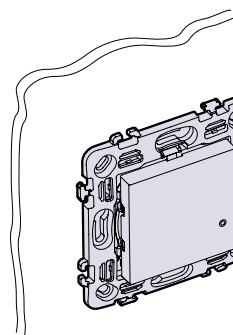

Item **RW/RG4003CW**  
Wireless wall mounted control

You can now expand the system with radio controls.

### 5. Download the Home+Control App from the stores and follow the guided procedure to define the objects to manage



App Home + Control



## SMART ELECTRICAL SYSTEM - EUROPE VERSION

### Wired controls for light and shutter

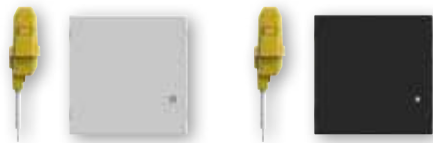

RW4411CM2

RG4411CM2



RW4412CM2

RG4412CM2



RW4027CM2

RG4027CM2

Item

#### CONNECTED DEVICES FOR LIGHT

<input type="checkbox"/> RW4411CM2	<p>Dimmer/switch without neutral. It allows to control lights locally or remotely, with the dimmer functionality that can be activated from APP Home+Control.</p> <p>It has the same installation and usability of a traditional switch and it is compatible with all loads (LED, halogen) with power 5-300 W at 230 V. It is equipped with a blue LED light used for localization modality or load status modality, configurable by APP. It can be connected associated with "wireless light switches".</p> <p>It doesn't require connection to the neutral, it comes with an active compensator.</p> <p>Power supply 110-230 Va.c. - 2 modules - white</p>
■ RG4411CM2	as above - black
<input type="checkbox"/> RW4412CM2	<p>Dimmer/switch with neutral. It allows to control lights locally or remotely, with the dimmer functionality that can be activated from APP Home+Control.</p> <p>It has the same installation and usability of a traditional switch and it is compatible with all loads (LED, halogen) with power 5-300 W at 230 V. It is equipped with a blue LED light used for localization modality or load status modality, configurable by APP. It can be connected associated with "wireless light switches".</p> <p>It doesn't require connection to the neutral, it comes with an active compensator.</p> <p>Power supply 110-230 Va.c. - 2 modules - white</p>
■ RG4412CM2	as above - black

#### CONNECTED DEVICES FOR SHUTTERS

<input type="checkbox"/> RW4027CM2	<p>Connected rolling shutter switch - It allows the control of a shutter locally or remotely. Compatible with all standard rolling shutter motors ( with a mechanical or electromechanical stop and max power 500 VA ) controlled by a wired shutter switch (switching of the same motor power supply). Not compatible with motors for radio-controlled or pulse-controlled roller shutters. It can be associated with one or more wireless commands.</p> <p>Caution: Must be connected to the neutral.</p> <p>Power supply 110-230 Va.c. - 2 modules - white</p>
■ RG4027CM2	as above - black

## Wireless controls for light, shutter and scenario



RW4003CW



RG4003CW

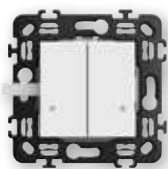

RW4003DCW



RG4003DCW

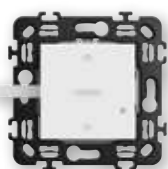

RW4027CW



RG4027CW

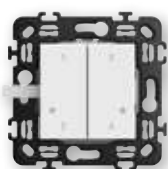

RW4575CW



RG4575CW

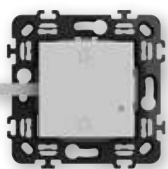

RW4570CW



RG4570CW

Item

### WIRELESS CONTROLS FOR LIGHT

<input type="checkbox"/> RW4003CW	Wireless light switch. It allows the ON / OFF and dimming control of one or more connected devices for the lighting control. Surface installation with repositionable stickers (supplied) or onto a flush mounting box. The battery can be replaced without removing it from the supporting frame. Integrated LED for low battery indication. Powered by battery 3V type CR2032 (supplied) with an autonomy of 8 years - 2 modules - white
<input checked="" type="checkbox"/> RG4003CW	as above - black
<input type="checkbox"/> RW4003DCW	Wireless light switch. It is equipped with two buttons to control two different connected devices for lights. Each single button can be associated with one or more devices. Surface installation with repositionable stickers (supplied) or onto a flush mounting box. Integrated LED for low battery indication. Powered by battery 3V type CR2032 (supplied) with an autonomy of 8 years - 2 modules - white
<input checked="" type="checkbox"/> RG4003DCW	as above - black

### WIRELESS CONTROLS FOR SHUTTER

<input type="checkbox"/> RW4027CW	Rolling shutter wireless switch - It allows the control of one or more connected rolling shutter switches. Surface installation with repositionable stickers (supplied) or onto a flush mounting box. Integrated LED for low battery indication. Powered by battery 3V type CR2032 (supplied) with an autonomy of 8 years - 2 modules - white
<input checked="" type="checkbox"/> RG4027CW	as above - black

### WIRELESS 4 SCENARIOS CONTROL

<input type="checkbox"/> RW4575CW	it's equipped with 4 buttons for activating of scenarios 1,2,3 and 4.Scenarios can be customized by the Home+ Control app. Surface installation withrepositionable stickers (supplied) or onto a flushmounting box.Integrated LED for low battery indication.Powered by battery 3V type CR2032 (supplied)with an autonomy of 8 years - 2 modules - white
<input checked="" type="checkbox"/> RG4575CW	as above - black

### WIRELESS HOME/AWAY SCENARIO CONTROLS

<input type="checkbox"/> RW4570CW	Home / Away wireless switch. It is equipped with 2 buttons for activating Home / Away scenarios Scenarios can be customized by the Home + Control app. Surface installation with repositionable stickers (supplied) or onto a flush mounting box. Integrated LED for low battery indication. Powered by battery 3V type CR2032 (supplied) with an autonomy of 8 years - 2 modules - white
<input checked="" type="checkbox"/> RG4570CW	as above - black

## SMART ELECTRICAL SYSTEM - EUROPE VERSION

Wireless controls for light, shutter and scenario

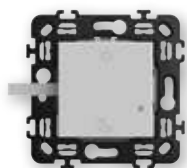

RW4574CW

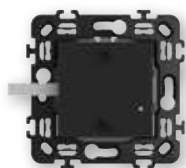

RG4574CW

Item

### WIRELESS WAKE UP/SLEEP SCENARIO CONTROLS

<input type="checkbox"/> RW4574CW	It is equipped with 2 buttons for activating Wake Up / Sleep scenarios. Scenarios can be customized by the Home + Control app. Surface installation with repositionable stickers (supplied) or onto a flush mounting box. Integrated LED for low battery indication. Powered by battery 3V type CR2032 (supplied) with an autonomy of 8 years - 2 modules - white
<input checked="" type="checkbox"/> RG4574CW	as above - black

## Gateway



RW4501C



RG4501C

Item

### GATEWAY WITH SOCKET (GERMAN STANDARD)

<input type="checkbox"/> RW4501C	This pack enables to create a connected installation in the home. It can be used to control lighting, roller shutters and electrical equipment plugged into connected sockets: - using your smartphone and the Home + Control app - using voice assistants - from the general control at the entrance to your home. Supplied with the flushmounted Home/Away wireless master switch 1 module required for the association procedure of all connected devices. Power supply 110-230 Va.c. - 2 modules - white
<input checked="" type="checkbox"/> RG4501C	as above - black

### GATEWAY DIN

<input type="checkbox"/> FC80GT	The device enables to create a connected installation in the home and can be used to control lighting, roller shutters and electrical equipment plugged into connected sockets: - using your smartphone and the Home + Control app - using voice assistants - from the general control at the entrance to your home. Power supply 110-230 Va.c. - 2 modules - white
---------------------------------	---



FC80GT

## Controls for light and shutter



FC80RC



3584C

### CONNECTED DEVICES FOR LIGHT

○ 3584C	<p>Connected lighting micromodule. It allows to control lights locally or remotely. It is compatible with all loads with max power 300 W. It can be connected to one or more traditional push-button or associated with "wireless light switches".</p> <p>It is installed as a traditional rele in the box (behind the button) or in derivation boxes. Caution: Must be connected to the neutral. Power supply 110-230 Va.c. - white</p>
○ FC80RC	<p>DIN switchboard light device for loads with absorption <math>I_n = 16</math> A. Equipped with a meter measuring the current absorbed by the load and contacts for control with up to 10 pushbuttons. Power supply 110-230 Va.c. - 1 DIN module - white</p>



4027C

### CONNECTED DEVICES FOR SHUTTERS

○ 4027C	<p>Connected micromodule for shutters. Associated to one or more shutter wireless controls, it controls a shutter locally or remotely. Compatible with all standard shutter motors (with mechanical or electronic limit switch and maximum power 500 VA), controlled by a wired shutter changeover switch (changeover with the same power supply as the motor).</p> <p>Not compatible with radio controlled or pulse controlled shutter motors.</p> <p>It can be installed in the existing shutter box with no need of masonry works. Power supply 110-230 Va.c. - white</p>
---------	--



3528C

### POCKET REMOTE CONTROL 4 SCENARIOS

○ 3528C	<p>It allows to add a wireless remote control in your system. Is equipped with 4 keys for the activation of the 1,2,3 and 4 scenarios. The scenarios can be activated and customized by the Home + Control app. Integrated LED for low battery indication. Powered by battery 3V type CR2032 (supplied) with an autonomy of 8 years.</p>
---------	--

## SMART ELECTRICAL SYSTEM - EUROPE VERSION

### Controls for energy management and light



RW4141AC



RG4141AC



F20T60A  
FC80GCS



FC80CC



4141PC



3585C

Item

#### CONNECTED SOCKETS

- RW4141AC** 2P+E 16 A 250 Va.c. German standard connected socket. It allows remote control of electric devices and also to monitor their consumption (instantaneous, daily, monthly). It is also possible to receive notifications that can be configured. Compatible with all the electric devices with power up to 16 A 3680W (with overload protection). Integrated with a 2-module support, it can be installed instead of an existing socket in a 40 mm deep box. Screw fixing and connection using automatic clamps. It has a blue LED that lights up when the socket is ON and that can be configured by means of the Home + Control APP. It can be associated to one or more wireless light controls. Power supply 110-230 Va.c. - white
- RG4141AC** as above - black

#### CONNECTED DEVICES FOR ENERGY MANAGEMENT

- FC80CC** Connected contactor for single-phase and/or three-phase loads with maximum absorption  $I_n = 20$  A. With meter for the measurement of the current absorbed by the load. Power supply 110-230 Va.c. - 1 DIN module - white
- F20T60A** Smart DIN meter. It allows to measure the electrical energy consumption of the entire single-phase system of the house (instantaneous, daily, monthly) and of the single electrical power lines. It allows the reception of notifications in case of reaching the maximum power foreseen by the contract to avoid annoying black-outs. A toroid is supplied to measure the input current. Power supply 100-240 Va.c. 1 DIN module. (Only for single-phase systems).
- FC80GCS** Connected DIN load management module for the monitoring of the consumptions of the whole electric system, the powering or disconnection of the loads, and the setting of scenarios with priority or non-priority loads. When the maximum intended power is reached, the non-priority loads are temporarily disconnected to avoid black-outs. A toroid for the current reading is provided. Power supply 110-230 Va.c. - 1 DIN module - white

#### CONNECTED PLUG&PLAY SOCKET

Directly connected to an existing socket, it allows remote control of all the connected electrical appliances. It also monitors the instantaneous, daily and monthly consumption. Compatible with all the devices with power up to 16 A 3680 W (with overload protection). It can be associated to wireless light controls. Power supply 110-230 V Va.c. - white

- 4141PC** Shuko standard socket

#### WIRELESS CONTROLS FOR LIGHT

- 3585C** it controls one or more devices connected for light control. Infrared detection with angle of 140°. Distance of the adjustable sensor from 2 to 8 m. Switch off delay with 1 to 30 min adjustable delay time and 1 to 1000 lux brightness threshold. Test possible with a 5 sec. delay. Recommended assembly height: 2.5 m. Optimum distance between 2 detectors: 6 m. For indoor and outdoor use (IP44). Supplied with 2 1.5V AA batteries for power supply - white

# Thermostat



XW8002  
XW8002W



XG8002

Item	CONNECTED THERMOSTAT
<input type="checkbox"/> XW8002	<p>The Smarter with Netatmo connected thermostat, together with the dedicated HOME+CONTROL APP, is a device which allows you to adjust and monitor the temperature in the rooms precisely and accurately; all the programming and most of the functions are performed simply and intuitively using the APP. Thanks to its Wi-Fi connection, Smarter with Netatmo can be programmed and controlled remotely; it can also display the temperature and humidity measured in the room. The temperature level can be set locally for manual operation and the Boost mode can be activated. The Boost forces the switching on of the system for a limited time (30, 60 or 90 minutes) independent of the measured and programmed temperature.</p> <p>It's also possible to set a different temperature in each room of the house for the maximum comfort, thanks to its compatibility with Netatmo's smart radiator valves. Smarter with Netatmo can also be controlled with Google, Amazon Alexa and Apple Home Kit voice assistants.</p> <p>Features:</p> <ul style="list-style-type: none"> <li>- 110 ÷ 230 Va.c., 50/60 Hz power supply;</li> <li>- 2 W max absorption;</li> <li>- maximum cable section 1 x 1.5mm<sup>2</sup>;</li> <li>- temperature measurement 5 ÷ 40°C;</li> <li>- temperature set-point 5 ÷ 40°C,</li> <li>- increase of 0.5°C;</li> <li>- 1-contact output in switching free of potential 5(2)A.</li> </ul> <p>Types of installation:</p> <ul style="list-style-type: none"> <li>- flush mounted, on boxes item 503E or 500 (for item 500 use the wall dowels)</li> <li>- plasterboard, on boxes 2 module e 3 module</li> </ul> <p>It is available in three colours: white (XW8002), sand (XM8002) and black (XG8002) - white</p>
<input checked="" type="checkbox"/> XG8002	as above - black
<input type="checkbox"/> XW8002W	Features: as ..8002. Installation: on the wall, using screws and dowels suitable for the installation surface (brickwork, plasterboard, tiles etc.). It is only available in white.



App HOME + CONTROL for management of connected devices



Smarter, the connected thermostat, has been awarded this prestigious international recognition confirming BTicino's capacity in combining technology and design.

## Smart electrical system

A simple, rational range of connected devices, both wired and wireless.

### REMOTE CONNECTION

#### CONNECTED DEVICES (230V A.C.)

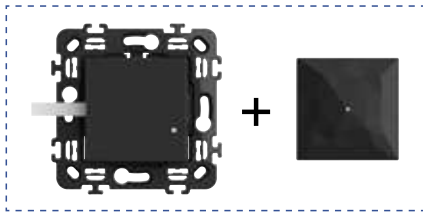

**Item RW/RG4500C**  
Gateway with In&Out scenario control



**Item FC80GT**  
Gateway DIN

### SCENARIOS

#### BATTERY WIRELESS CONTROLS

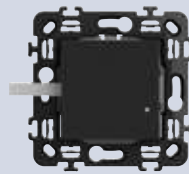

**Item RW/RG4570CW**  
In&Out scenario control

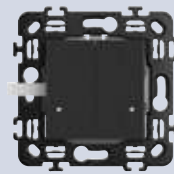

**Item RW/RG4575CW**  
4 scenarios control

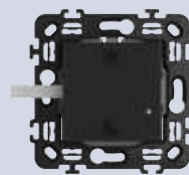

**Item RW/RG4574CW**  
Night&Day scenario control



LIGHTS

SHUTTERS

ENERGY AND CONSUMPTION MANAGEMENT



**Item FC80RC**  
Connected DIN  
relay  
16 A



**Item 3584C**  
Connected  
light relay  
1,3 A



**Item RW/RG4027C**  
Connected  
shutter control

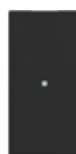

**Item RW/RG4531C**  
Connected module  
for socket -16 A



**Item FC80CC**  
Connected DIN  
contactor 20 A



**Item RW/RG4003C**  
Connected  
two-way switch



**Item RW/RG4411C**  
Connected  
switch/dimmer



**Item 4027C**  
Connected  
micromodule  
for shutter



**Item F20T60A** Smart  
DIN meter  
**Item FC80GCS** Connected  
DIN load management



**Item RW/RG4003CW**  
Light control



**Item 4141PC**  
Mobile german  
standard power outlet

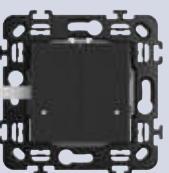

**Item RW/RG4003DCW**  
Double light control



**Item 3585C**  
Motion sensor



**Item 3577C**  
Wireless module  
for mechanical  
switch

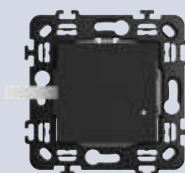

**Item RW/RG4027CW**  
Shutter control

Connected  
thermostat  
**Item XW8002**  
**Item XW8002W**  
**Item XG8002**



**Note:** The devices are also available in Light white and Tech gray finishes.  
See catalogue for detailed descriptions, availability and full range of products.

Turn a traditional system into a Smart system with just a few simple steps.

1. Install the gateway in the switchboard, or flush mounted in a desired position, or near an existing socket

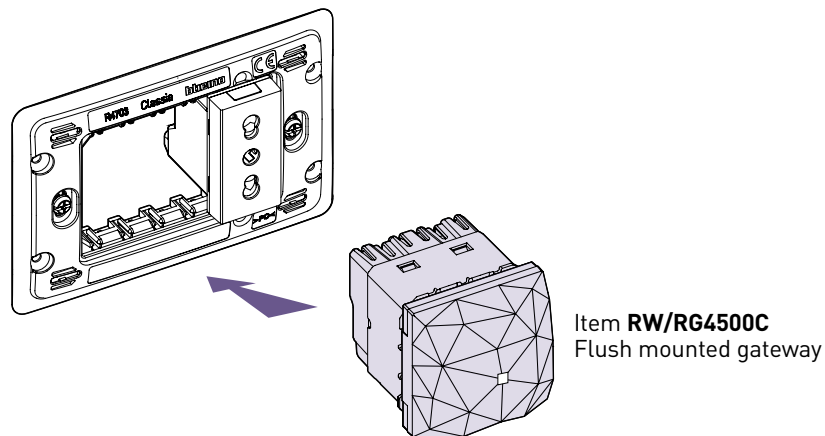

Ensure appropriate home Wi-Fi signal.

2. Replace current devices with the connected devices for your type of system.

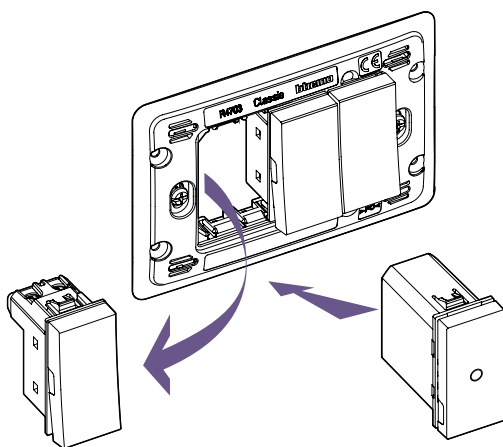

In place of a traditional device, install the connected device of the corresponding type for the managing of lights, shutters and sockets: one for each control line.

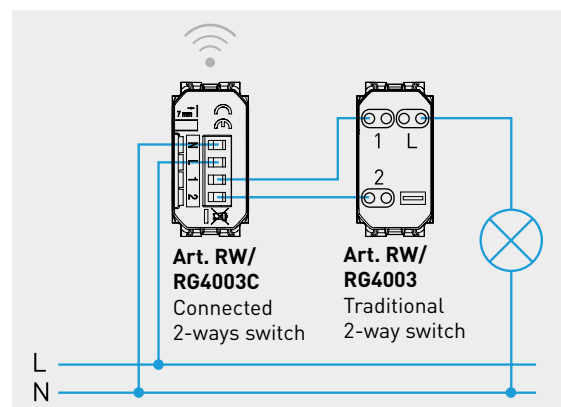

Remember that the device must always be powered; therefore, ensure that the phase and neutral cables are present.

### 3. Add the energy meter module if desired

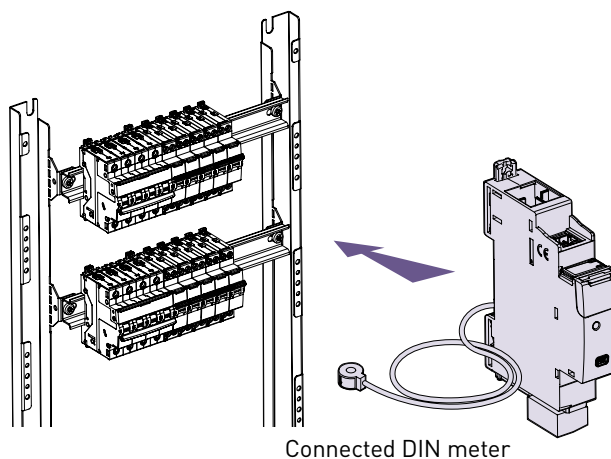

Connected DIN meter

### 4. Devices can be associated to each other by simply pressing a pushbutton

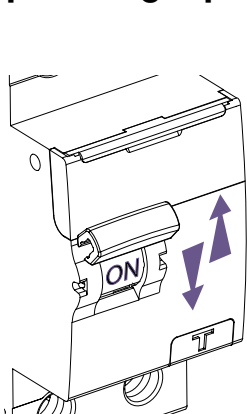

Switch the system off and on.

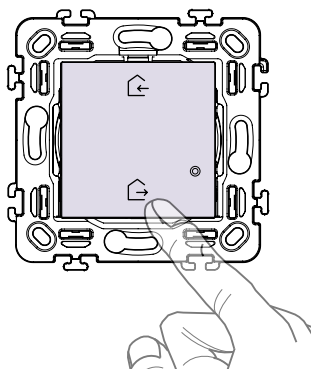

Press the In&Out master scenario control supplied with the gateway for 5 seconds. Devices are associated to each other.

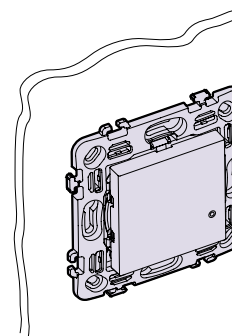

Item **RW/RG4003CW**  
Wireless  
wall mounted control

You can now expand the system with radio controls.

### 5. Download the Home+Control App from the stores and follow the guided procedure to define the objects to manage



App Home + Control



## SMART ELECTRICAL SYSTEM - MODULAR VERSION

### Wired controls for light and shutter



RW4003C



RG4003C



RW4411C



RG4411C



RW4027C



RG4027C

Item

#### CONNECTED DEVICES FOR LIGHT

<input type="checkbox"/> RW4003C	Connected 2-ways switch. It allows to control lights locally or remotely. The connected 2ways switch has the same installation and usability of a traditional 2ways switch and it is compatible with all loads with max power 250 W. It is equipped with a blue LED light used always on for localization modality or on, when the light is on for the load status modality. It can be associated with "wireless light switches". Caution: Must be connected to the neutral. Power supply 110-230 Va.c. - 1 module - white
■ RG4003C	as above - black
<input type="checkbox"/> RW4411C	Dimmer/switch. It allows to control lights locally or remotely, with the dimmer functionality that can be activated from APP Home+Control. It has the same installation and usability of a traditional switch and it is compatible with all loads (LED, halogen) with max power 150 W at 230 V (or 75 W at 110 V). It is equipped with a blue LED light used for localization modality or load status modality, configurable by APP. It can be connected to one or more traditional push-button or associated with "wireless light switches". Caution: Must be connected to the neutral. Power supply 110-230 Va.c. - 1 module - white
■ RG4411C	as above - black

#### CONNECTED DEVICES FOR SHUTTERS

<input type="checkbox"/> RW4027C	Connected rolling shutter switch - It allows the control of a shutter locally or remotely. Compatible with all standard rolling shutter motors ( with a mechanical or electromechanical stop and max power 500 VA ) controlled by a wired shutter switch (switching of the same motor power supply). Not compatible with motors for radio-controlled or pulse-controlled roller shutters. It can be associated with one or more wireless commands. Caution: Must be connected to the neutral. Power supply 110-230 Va.c. - 1 module - white
■ RG4027C	as above - black

# SMART ELECTRICAL SYSTEM - MODULAR VERSION

## Wireless controls for light, shutter and scenario



RW4003CW



RG4003CW

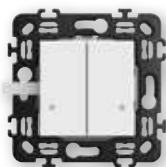

RW4003DCW



RG4003DCW

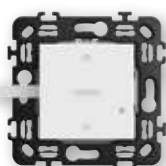

RW4027CW

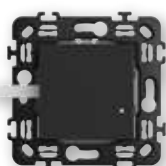

RG4027CW

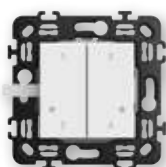

RW4575CW

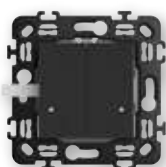

RG4575CW



RW4570CW

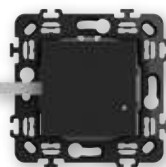

RG4570CW

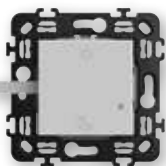

RW4574CW

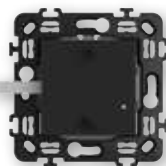

RG4574CW

Item	WIRELESS CONTROLS FOR LIGHT
<input type="checkbox"/> RW4003CW	Wireless light switch. It allows the ON / OFF and dimming control of one or more connected devices for the lighting control. Surface installation with repositionable stickers (supplied) or onto a flush mounting box. The battery can be replaced without removing it from the supporting frame. Integrated LED for low battery indication. Powered by battery 3V type CR2032 (supplied) with an autonomy of 8 years - 2 modules - white
<input checked="" type="checkbox"/> RG4003CW	as above - black
<input type="checkbox"/> RW4003DCW	Wireless light switch. It is equipped with two buttons to control two different connected devices for lights. Each single button can be associated with one or more devices. Surface installation with repositionable stickers (supplied) or onto a flush mounting box. Integrated LED for low battery indication. Powered by battery 3V type CR2032 (supplied) with an autonomy of 8 years - 2 modules - white
<input checked="" type="checkbox"/> RG4003DCW	as above - black

Item	WIRELESS CONTROLS FOR SHUTTER
<input type="checkbox"/> RW4027CW	Rolling shutter wireless switch - It allows the control of one or more connected rolling shutter switches. Surface installation with repositionable stickers (supplied) or onto a flush mounting box. Integrated LED for low battery indication. Powered by battery 3V type CR2032 (supplied) with an autonomy of 8 years - 2 modules - white
<input checked="" type="checkbox"/> RG4027CW	as above - black

Item	WIRELESS 4 SCENARIOS CONTROL
<input type="checkbox"/> RW4575CW	it's equipped with 4 buttons for activating of scenarios 1,2,3 and 4.Scenarios can be customized by the Home+ Control app. Surface installation withrepositionable stickers (supplied) or onto a flushmounting box.Integrated LED for low battery indication.Powered by battery 3V type CR2032 (supplied)with an autonomy of 8 years - 2 modules - white
<input checked="" type="checkbox"/> RG4575CW	as above - black

Item	WIRELESS HOME/AWAY SCENARIO CONTROLS
<input type="checkbox"/> RW4570CW	Home / Away wireless switch. It is equipped with 2 buttons for activating Home / Away scenarios Scenarios can be customized by the Home + Control app. Surface installation with repositionable stickers (supplied) or onto a flush mounting box. Integrated LED for low battery indication. Powered by battery 3V type CR2032 (supplied) with an autonomy of 8 years - 2 modules - white
<input checked="" type="checkbox"/> RG4570CW	as above - black

Item	WIRELESS WAKE UP/SLEEP SCENARIO CONTROLS
<input type="checkbox"/> RW4574CW	It is equipped with 2 buttons for activating Wake Up / Sleep scenarios. Scenarios can be customized by the Home + Control app. Surface installation with repositionable stickers (supplied) or onto a flush mounting box. Integrated LED for low battery indication. Powered by battery 3V type CR2032 (supplied) with an autonomy of 8 years - 2 modules - white
<input checked="" type="checkbox"/> RG4574CW	as above - black

# SMART ELECTRICAL SYSTEM - MODULAR VERSION

## Gateway



RW4500C

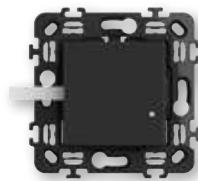

RG4500C



Item

### GATEWAY

- RW4500C** This pack enables to create a connected installation in the home. It can be used to control lighting, roller shutters and electrical equipment plugged into connected sockets:
  - using your smartphone and the Home + Control app
  - using voice assistants
  - from the general control at the entrance to your home
 Supplied with the Home/Away wireless master switch required for the association procedure of all connected devices. Power supply 110-230 Va.c. - 2 modules - white
- RG4500C** as above - black



FC80GT

### GATEWAY DIN

- FC80GT** The device enables to create a connected installation in the home and can be used to control lighting, roller shutters and electrical equipment plugged into connected sockets: - using your smartphone and the Home + Control app - using voice assistants - from the general control at the entrance to your home. Power supply 110-230 Va.c. - 2 modules - white



3528C

### POCKET REMOTE CONTROL 4 SCENARIOS

- 3528C** It allows to add a wireless remote control in your system. Is equipped with 4 keys for the activation of the 1,2,3 and 4 scenarios. The scenarios can be activated and customized by the Home + Control app. Integrated LED for low battery indication. Powered by battery 3V type CR2032 (supplied) with an autonomy of 8 years.

## Controls for light and shutter



FC80RC



3584C

Item

### CONNECTED DEVICES FOR LIGHT

- 3584C** Connected lighting micromodule. It allows to control lights locally or remotely. It is compatible with all loads with max power 300 W. It can be connected to one or more traditional push-button or associated with "wireless light switches". It is installed as a traditional rele in the box (behind the button) or in derivation boxes. Caution: Must be connected to the neutral. Power supply 110-230 Va.c. - white
- FC80RC** DIN switchboard light device for loads with absorption  $I_n = 16$  A. Equipped with a meter measuring the current absorbed by the load and contacts for control with up to 10 pushbuttons. Power supply 110-230 Va.c. - 1 DIN module - white

### CONNECTED DEVICES FOR SHUTTERS

- 4027C** Connected micromodule for shutters. Associated to one or more shutter wireless controls, it controls a shutter locally or remotely. Compatible with all standard shutter motors (with mechanical or electronic limit switch and maximum power 500 VA), controlled by a wired shutter changeover switch (changeover with the same power supply as the motor). Not compatible with radio controlled or pulse controlled shutter motors. It can be installed in the existing shutter box with no need of masonry works. Power supply 110-230 Va.c. - white



4027C

# SMART ELECTRICAL SYSTEM - MODULAR VERSION

## Controls for energy management and light



RW4531C

RG4531C

Item

### CONNECTED DEVICES FOR ENERGY MANAGEMENT

<input type="checkbox"/> RW4531C	Connected socket module - wiring to a power outlet, allows to remotely control appliances and check the consumption (instantaneous, daily, monthly). It is also possible to receive notifications in case of anomalous consumption. The connected socket module is compatible with any device electric and large appliances up to 16 A 3680 W max. (protected against overloads). It is equipped with a LED light lit in blue when it is on. This option can be enabled or disabled in the "Home+Control" app. It can be associated with "wireless light switches". Power supply 110-230 Va.c. - 1 module - white
<input checked="" type="checkbox"/> RG4531C	as above - black

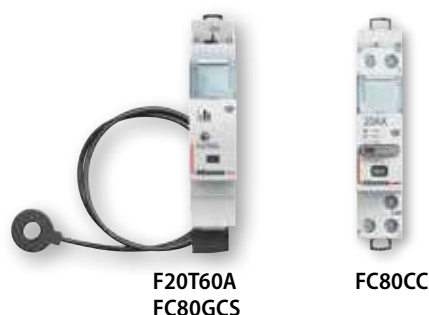

F20T60A  
FC80GCS

FC80CC

### CONNECTED DEVICES FOR ENERGY MANAGEMENT

<input type="checkbox"/> FC80CC	Connected contactor for single-phase and/or three-phase loads with maximum absorption $I_n = 20$ A. With meter for the measurement of the current absorbed by the load. Power supply 110-230 Va.c. - 1 DIN module - white
<input type="checkbox"/> F20T60A	Smart DIN meter. It allows to measure the electrical energy consumption of the entire single-phase system of the house (instantaneous, daily, monthly) and of the single electrical power lines. It allows the reception of notifications in case of reaching the maximum power foreseen by the contract to avoid annoying black-outs. A toroid is supplied to measure the input current. Power supply 100-240 Va.c. 1 DIN module. (Only for single-phase systems).
<input type="checkbox"/> FC80GCS	Connected DIN load management module for the monitoring of the consumptions of the whole electric system, the powering or disconnection of the loads, and the setting of scenarios with priority or non-priority loads. When the maximum intended power is reached, the non-priority loads are temporarily disconnected to avoid black-outs. A toroid for the current reading is provided. Power supply 110-230 Va.c. - 1 DIN module - white



4141PC

### CONNECTED PLUG&PLAY SOCKET

Directly connected to an existing socket, it allows remote control of all the connected electrical appliances. It also monitors the instantaneous, daily and monthly consumption. Compatible with all the devices with power up to 16 A 3680 W (with overload protection). It can be associated to wireless light controls. Power supply 110-230 V Va.c. - white

<input type="checkbox"/> 4141PC	Shuko standard socket
---------------------------------	-----------------------



3585C

















### WIRELESS CONTROLS FOR LIGHT

<input type="checkbox"/> 3585C	It controls one or more devices connected for light control. Infrared detection with angle of 140°. Distance of the adjustable sensor from 2 to 8 m. Switch off delay with 1 to 30 min adjustable delay time and 1 to 1000 lux brightness threshold. Test possible with a 5 sec. delay. Recommended assembly height: 2.5 m. Optimum distance between 2 detectors: 6 m. For indoor and outdoor use (IP44). Supplied with 2 1.5V AA batteries for power supply - white
--------------------------------	--

# COVER PLATES: TABLE FOR SELECTING CODE

## Area Europa installation system









































### SUPPORTS

	1 centered	2	2+2 "horizontal/vertical instal."	2+2+2 "horizontal/vertical instal."	2+2+2+2 "horizontal/vertical instal."	2+2+2+2+2 "horizontal/vertical instal."
<b>BASICS</b>						
 White	R4801RW	R4802RW	R4802M2RW	R4802M3RW	R4802M4RW	R4802M5RW
 Cream	R4801CR	R4802CR	R4802M2CR	R4802M3CR	R4802M4CR	R4802M5CR
 Moka	R4801MK	R4802MK	R4802M2MK	R4802M3MK	R4802M4MK	R4802M5MK
 Black	R4801BC	R4802BC	R4802M2BC	R4802M3BC	R4802M4BC	R4802M5BC
<b>FRAMES</b>						
 Ice satin	R4801ES	R4802ES	R4802M2ES	R4802M3ES	R4802M4ES	R4802M5ES
 Cream satin	R4801CS	R4802CS	R4802M2CS	R4802M3CS	R4802M4CS	R4802M5CS
 White satin	R4801WS	R4802WS	R4802M2WS	R4802M3WS	R4802M4WS	R4802M5WS
 Black satin	R4801BG	R4802BG	R4802M2BG	R4802M3BG	R4802M4BG	R4802M5BG
<b>FINISHES</b>						
 Titanium metal	R4801TM	R4802TM	R4802M2TM	R4802M3TM	R4802M4TM	R4802M5TM
 Siena soft	R4801SF	R4802SF	R4802M2SF	R4802M3SF	R4802M4SF	R4802M5SF
 Blue metal	R4801LM	R4802LM	R4802M2LM	R4802M3LM	R4802M4LM	R4802M5LM
 Terra soft	R4801TF	R4802TF	R4802M2TF	R4802M3TF	R4802M4TF	R4802M5TF
<b>ACCENTS</b>						
 White gold	R4801WD	R4802WD	R4802M2WD	R4802M3WD	R4802M4WD	R4802M5WD
 White chrome	R4801WR	R4802WR	R4802M2WR	R4802M3WR	R4802M4WR	R4802M5WR
 Black nickel	R4801BH	R4802BH	R4802M2BH	R4802M3BH	R4802M4BH	R4802M5BH
 Black gold	R4801BD	R4802BD	R4802M2BD	R4802M3BD	R4802M4BD	R4802M5BD

### FRAME

R4702G with clips R4702 with screws	R4702G with clips R4702 with screws	2 x R4702G with clips 2 x R4702 with screws	3 x R4702G with clips 3 x R4702 with screws	4 x R4702G with clips 4 x R4702 with screws	5 x R4702G with clips 5 x R4702 with screws
--	--	--	--	--	--

### SELECTION TABLE

Installation with CLIPS (masonry)	 500  R4702G	 500  R4702G	 2 x 500  2 x R4702G	 3 x 500  3 x R4702G	 4 x 500  4 x R4702G	 5 x 500  5 x R4702G
Installation with SCREW (masonry and plasterboard)	 502E	 502E	 2 x 502E	 3 x 502E	 4 x 502E	 5 x 502E
	 PB502N	 PB502N				
	 R4702	 R4702	 2 x R4702	 3 x R4702	 4 x R4702	 5 x R4702
No. of modules	 1 centered	 2 modules	 2+2 modules	 2+2+2 modules	 2+2+2+2 modules	 2+2+2+2+2 modules
Cover plates	 R4801...	 R4802...	 R4802M2..	 R4802M3..	 R4802M4..	 R4802M5..

## Area Italian installation system

### SUPPORTS













	1 centered	2 centered	3	4	7
<b>BASICS</b>					
White	R4803M1RW	R4819RW	R4803RW	R4804RW	R4807RW
Cream	R4803M1CR	R4819CR	R4803CR	R4804CR	R4807CR
Moka	R4803M1MK	R4819MK	R4803MK	R4804MK	R4807MK
Black	R4803M1BC	R4819BC	R4803BC	R4804BC	R4807BC
<b>FRAMES</b>					
Ice satin	R4803M1ES	R4819ES	R4803ES	R4804ES	R4807ES
Cream satin	R4803M1CS	R4819CS	R4803CS	R4804CS	R4807CS
White satin	R4803M1WS	R4819WS	R4803WS	R4804WS	R4807WS
Black satin	R4803M1BG	R4819BG	R4803BG	R4804BG	R4807BG
<b>FINISHES</b>					
Titanium metal	R4803M1TM	R4819TM	R4803TM	R4804TM	R4807TM
Siena soft	R4803M1SF	R4819SF	R4803SF	R4804SF	R4807SF
Blue metal	R4803M1LM	R4819LM	R4803LM	R4804LM	R4807LM
Terra soft	R4803M1TF	R4819TF	R4803TF	R4804TF	R4807TF
<b>ACCENTS</b>					
White gold	R4803M1WD	R4819WD	R4803WD	R4804WD	R4807WD
White chrome	R4803M1WR	R4819WR	R4803WR	R4804WR	R4807WR
Black nickel	R4803M1BH	R4819BH	R4803BH	R4804BH	R4807BH
Black gold	R4803M1BD	R4819BD	R4803BD	R4804BD	R4807BD
<b>FRAME</b>					
	R4703	R4703	R4703	R4704	R4707

### SELECTION TABLE

Masonry	503E	503E	503E	504E	506L
Plasterboard boxes	PB503N	PB503N	PB503N	PB504N	PB506N
Frames	R4703	R4703	R4703	R4704	R4707
No. of modules	1 centered	2 centered	3	4	7
Cover plates	R4803M1..	R4819..	R4803..	R4804..	R4807..

The frame can be installed on all the market boxes.

# COVER PLATES COLOURS

BASICS				
	White - <b>RW</b>	Cream - <b>CR</b>	Moka - <b>MK</b>	Black - <b>BC</b>
FRAMES				
	Ice satin - <b>ES</b>	Cream satin - <b>CS</b>	White satin - <b>WS</b>	Black satin - <b>BG</b>
FINISHES				
	Titanium metal - <b>TM</b>	Siena soft - <b>SF</b>	Blue metal - <b>LM</b>	Terra soft - <b>TF</b>
ACCENTS				
	White gold - <b>WD</b>	White chrome - <b>WR</b>	Black nickel - <b>BH</b>	Black gold - <b>BD</b>

# CLASSIA

## Dimensional data

### COVER PLATES

#### Area Europa installation system

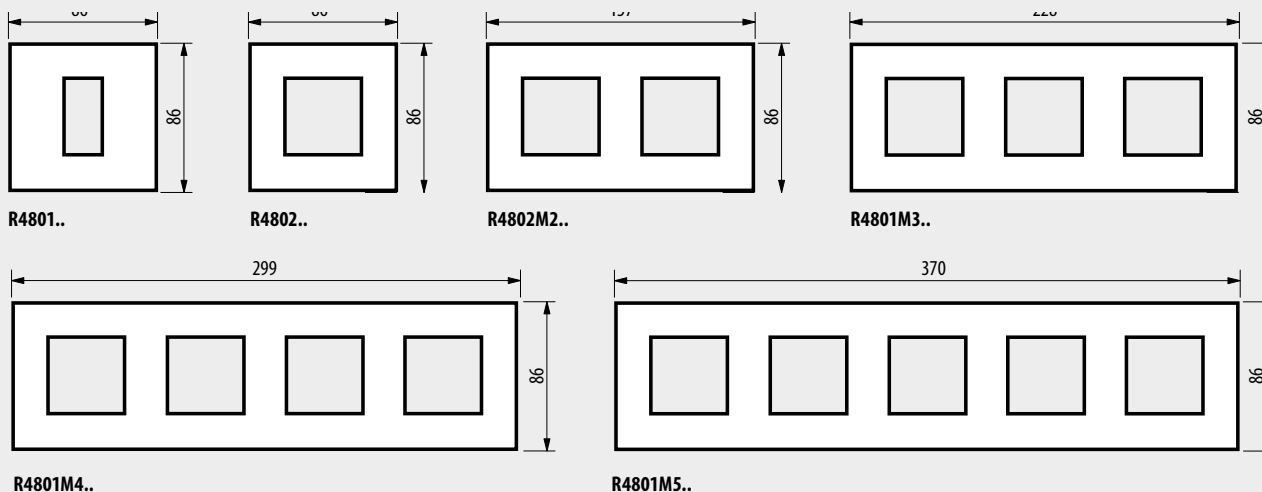

#### Area Italian installation system

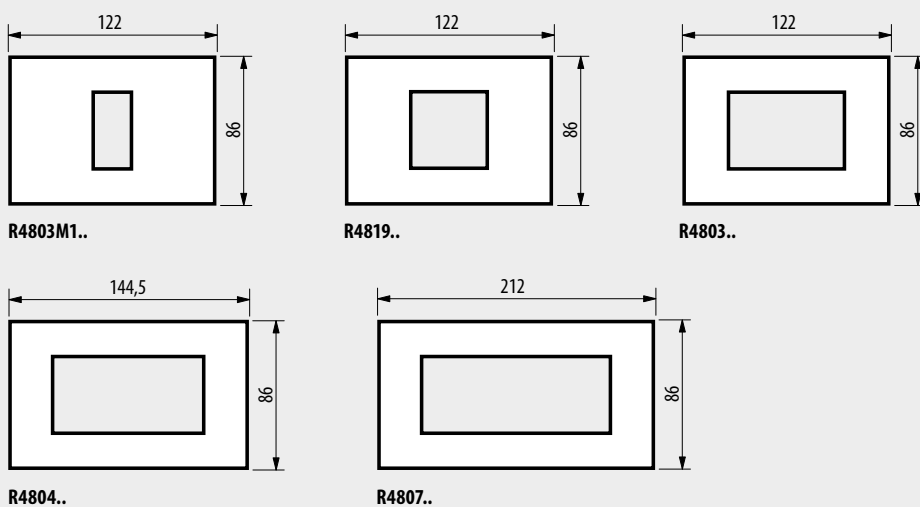

### SUPPORT FRAMES

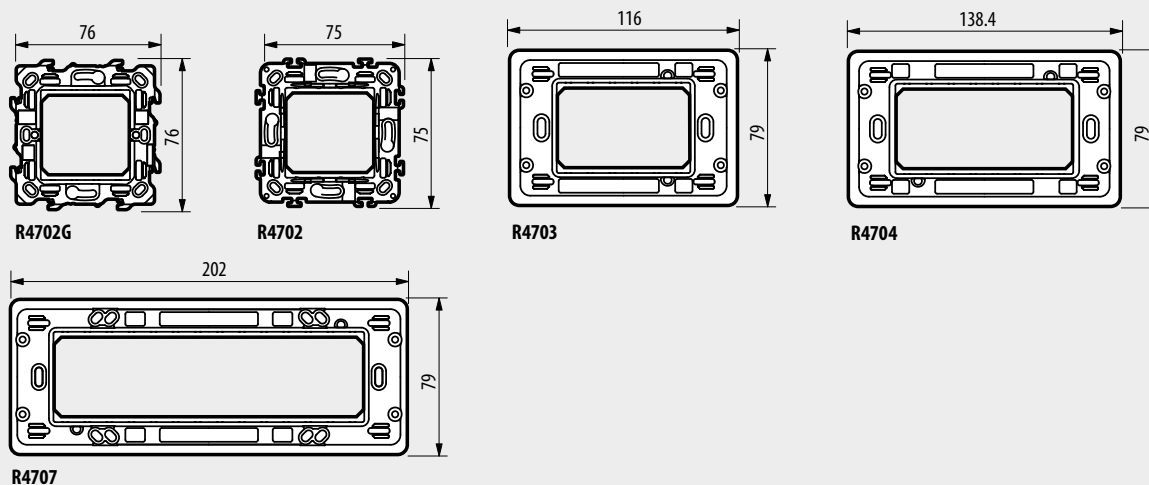

# CLASSIA

## Packaging

---

It has been designed for both retail and DIY exposure:  
each product has a single packaged



- Euroslot
- Security information inside on 11 languages
- Ean code
- Info for packaging recycling
- QR code for technical information

Discover more



[bticino.com](http://bticino.com)



**BTicino** SpA  
Viale Borri, 231  
21100 Varese - Italy  
[www.bticino.com](http://www.bticino.com)

BTicino SpA reserves at any time the right to modify the contents of this booklet and to communicate, in any form and modality, the changes brought to the same.

AD-EXCLS21C/GB - Version 01/2021

**bticino**

A Group Brand |  **legrand**