



# Innovations 2022





**Self-setting – Gripping – ratcheting – the Joker 6004 now also in an insulated VDE version.**

- **The compact textile box with four adjustable Joker 6004 VDE covers all metric and imperial dimensions in the field of application from 7 to 19 mm or ¼" to ¾"**
- **Individually tested tools with insulated handles for safe working up to 1,000 volt, with anti-slip protection and sliding function for contactless and safe opening of the non-insulated jaws**
- **Automatic and continuous gripping of the hexagon screw or bolt**
- **Lever mechanism when gripping avoids slipping and damage**
- **Fast and consistent screwdriving without removing the wrench thanks to mechanical ratchet function**
- **Return angle of only 30° through placement in the corner-width rectangular prisms in the mouth**





### 6004 Joker VDE XS VDE-insulated, self-setting spanner



**Application:** Hexagonal screw heads and bolts with wrench sizes 7-10 (metric) or 1/4"-3/8" (imperial)

	mm	mm	mm	mm
05020150001	7-10	1/4"-3/8"	119	7,7

Available from January 2023

### 6004 Joker VDE S VDE-insulated, self-setting spanner



**Application:** Hexagonal screw heads and bolts with wrench sizes 10-13 (metric) or 7/16"-1/2" (imperial)

	mm	mm	mm	mm
05020151001	10-13	7/16"-1/2"	155	10

Available from January 2023

### 6004 Joker VDE M VDE-insulated, self-setting spanner



**Application:** Hexagonal screw heads and bolts with wrench sizes 13-16 (metric) or 1/2"-5/8" (imperial)

	mm	mm	mm	mm
05020152001	13-16	1/2"-5/8"	190	12,4

Available from January 2023



### 6004 Joker VDE L VDE-insulated self-setting spanner



**Application:** Hexagonal screw heads and bolts with wrench sizes 16-19 (metric) or 5/8"-3/4" (imperial)

	mm	mm	mm	mm
05020153001	16-19	5/8"-3/4"	226	14

Available from January 2023

## Joker 6004 VDE: automatically and continuously self-setting



With its automatically and continuously gripping parallel jaws the Joker 6004 VDE spanner covers all dimensions within the potential operative range. The tool finds the required size by itself when attaching it to the bolt or screw.

## Joker 6004 VDE: gentle to the screw

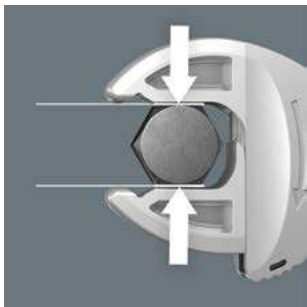

The parallel, smooth jaws of the Joker 6004 VDE offer a seating stress and can thus prevent the nut or screw head from rounding, which can occur when power is transmitted over corners.

## Joker 6004 VDE: ratchet mechanism for quick working



The ratchet function in the mouth sees to fast and consistent screwdriving without removing the tool.

## Joker 6004 VDE: low return angle

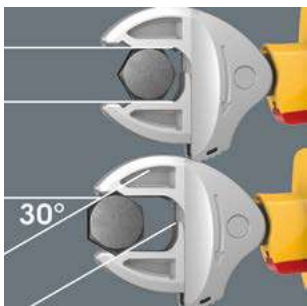

Thanks to the corner-width rectangular prisms, a return angle of only 30° can be achieved.

## Safe opening of the jaws

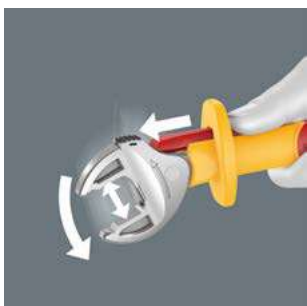

The sliding function allows contactless and safe opening of the non-insulated jaws.

## 6004 Joker VDE 4 Set 1 VDE-insulated self-setting spanner set



VDE-insulated self-setting spanner set

4-piece set

In a robust textile box

05020170001		
6004 Joker VDE XS	1x 7-10 ( $1/4''$ - $3/8''$ )x119	
6004 Joker VDE S	1x 10-13 ( $7/16''$ - $1/2''$ )x155	
6004 Joker VDE M	1x 13-16 ( $1/2''$ - $5/8''$ )x190	
6004 Joker VDE L	1x 16-19 ( $5/8''$ - $3/4''$ )x226	
K 120	1x 50,0x120,0	

Available from January 2023



## Individually tested



The individual testing at 10,000 volts, in accordance with IEC 60900, ensures safe working with loads up to 1,000 volts.

## New Zyklop Pocket ratchet with integrated bit magazine and combination mounting for bits and sockets.

- Compact Zyklop ratchet with integrated bit magazine
- Thanks to its clever design the ratchet head doubles up as both a  $\frac{3}{8}$ " square drive ratchet for sockets, and integral  $\frac{1}{4}$ " hexagon drive for screwdriver bits
- Freely pivoting ratchet head with 5 predefined locking positions
- Fine tooth reversible ratchet (72 teeth) for a low return angle of only  $5^\circ$
- Captive and freely swivelling bit magazine for easy removal and secure storage of the bits





## 8009 Zyklop Pocket Set 1



13-piece set; 1 Zyklop Pocket 8009 for  $\frac{3}{8}$ " sockets as well as  $\frac{3}{8}$ " connectors with square head drive; also suitable for bits with  $\frac{1}{4}$ " external hexagon drive as per DIN ISO 1173-C 6.3 and E 6.3 and Wera connection series 1 and 4.  $\frac{3}{8}$ " ratchet and  $\frac{1}{4}$ " bit ratchet screwdriver; freely swivelling ratchet head; pre-defined positions at 0°, 15° and 90° to the left and right; can be used as a conventional screwdriver in the 0° position; clockwise/counterclockwise switching, fine-toothed, small return angle of 5°; magnetic direct mounting. Multi-component Kraftform handle for fatigue-free working; captive, freely swivelling magazine with 12 bits integrated in the handle,  $\frac{1}{4}$ ", 25 mm length.

05004280001		
☐ ●	8009	1x $\frac{3}{8}$ "x $\frac{1}{4}$ "x133,0
⊕	851/1 BTZ	1x PH 1x25; 1x PH 2x25
⊕	855/1 BTZ	1x PZ 1x25; 1x PZ 2x25
⊕	867/1 TORX® BTZ	1x TX 10x25; 1x TX 15x25; 1x TX 20x25; 1x TX 25x25
○	840/1 BTZ	1x 3,0x25; 1x 4,0x25; 1x 5,0x25; 1x 6,0x25

## 8009 Zyklop Pocket Imperial Set 1



05004282001		
☐ ●	8009	1x $\frac{3}{8}$ "x $\frac{1}{4}$ "x133,0
⊕	851/1 BTZ	1x PH 1x25; 1x PH 2x25
⊕	867/1 TORX® BTZ	1x TX 10x25; 1x TX 15x25; 1x TX 20x25; 1x TX 25x25
○	840/1 Z	1x $\frac{1}{8}$ "x25; 1x $\frac{9}{32}$ "x25; 1x $\frac{3}{16}$ "x25; 1x $\frac{1}{4}$ "x25
○	868/1 Z	1x # 1x25; 1x # 2x25



## Combination tool mounting



The magnetic direct mounting is suitable for  $\frac{3}{8}$ " sockets as well as  $\frac{1}{4}$ " bits.

## 8009 Zyklop Pocket Set 2



18-piece set; 1 Zyklop Pocket 8009 for  $\frac{3}{8}$ " sockets as well as  $\frac{3}{8}$ " connectors with square head drive; also suitable for bits with  $\frac{1}{4}$ " external hexagon drive as per DIN ISO 1173-C 6.3 and E 6.3 and Wera connection series 1 and 4.  $\frac{3}{8}$ " ratchet and  $\frac{1}{4}$ " bit ratchet screwdriver; freely swivelling ratchet head; pre-defined positions at 0°, 15° and 90° to the left and right; can be used as a conventional screwdriver in the 0° position; clockwise/counterclockwise switching, fine-toothed, small return angle of 5°; magnetic direct mounting. Multi-component Kraftform handle for fatigue-free working; captive, freely swivelling magazine with 12 bits integrated in the handle,  $\frac{1}{4}$ ", 25 mm length; one universal holder (75 mm length) with stainless steel sleeve and strong permanent magnet, suitable for mounting bits with  $\frac{1}{4}$ " external hexagon drive as per DIN ISO 1173-C 6.3 and Wera connection series 1; 3 Zyklop sockets,  $\frac{3}{8}$ "; one robust textile tool holster 9468, can be attached to the belt and docked onto the Wera 2go system.

05004281001		
☐ ●	8009	1x $\frac{3}{8}$ "x $\frac{1}{4}$ "x133,0
○ ●	893/1/1	1x $\frac{1}{4}$ "x75
⊕	851/1 BTZ	1x PH 1x25; 1x PH 2x25
⊕	855/1 BTZ	1x PZ 1x25; 1x PZ 2x25
⊕	867/1 TORX® BTZ	1x TX 10x25; 1x TX 15x25; 1x TX 20x25; 1x TX 25x25
○	840/1 BTZ	1x 3,0x25; 1x 4,0x25; 1x 5,0x25; 1x 6,0x25
●	8790 HMB	1x 8,0x29,0; 1x 10,0x29,0; 1x 13,0x29,0
	9468	1x 155,0x65,0
	K 70	1x 50,0x70,0



## 8009 Zyklop Pocket Imperial Set 2



18-piece set; 1 Zyklop Pocket 8009 for  $\frac{3}{8}$ " sockets as well as  $\frac{3}{8}$ " connectors with square head drive; also suitable for bits with  $\frac{1}{4}$ " external hexagon drive as per DIN ISO 1173-C 6.3 and E 6.3 and Wera connection series 1 and 4.  $\frac{3}{8}$ " ratchet and  $\frac{1}{4}$ " bit ratchet screwdriver; freely swivelling ratchet head; pre-defined positions at 0°, 15° and 90° to the left and right; can be used as a conventional screwdriver in the 0° position; clockwise/counterclockwise switching, fine-toothed, small return angle of 5°; magnetic direct mounting. Multi-component Kraftform handle for fatigue-free working; captive, freely swivelling magazine with 12 bits integrated in the handle,  $\frac{1}{4}$ ", 25 mm length; one universal holder (75 mm length) with stainless steel sleeve and strong permanent magnet, suitable for mounting bits with  $\frac{1}{4}$ " external hexagon drive as per DIN ISO 1173-C 6.3 and Wera connection series 1; 3 Zyklop sockets,  $\frac{3}{8}$ "; one robust textile tool holster 9468, can be attached to the belt and docked onto the Wera 2go system.

05004283001		
○●	8009	1x $\frac{3}{8}$ "x $\frac{1}{4}$ "x133,0
●○	893/1/1	1x $\frac{1}{4}$ "x75
⊕	851/1 BTZ	1x PH 1x25; 1x PH 2x25
⊗	867/1 TORX® BTZ	1x TX 10x25; 1x TX 15x25; 1x TX 20x25; 1x TX 25x25
○	840/1 Z	1x $\frac{1}{8}$ "x25; 1x $\frac{5}{32}$ "x25; 1x $\frac{3}{16}$ "x25; 1x $\frac{1}{4}$ "x25
○	868/1 Z	1x # 1x25; 1x # 2x25
●	8790 HMB	1x $\frac{5}{16}$ "x29,0; 1x $\frac{3}{8}$ "x29,0; 1x $\frac{1}{2}$ "x29,0
	9468	1x 155,0x65,0
	K 70	1x 50,0x70,0

### With integrated bit magazine

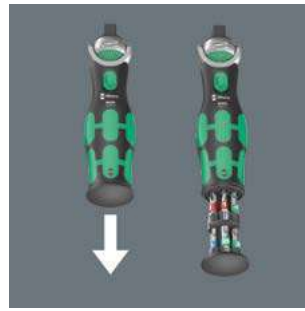

A captive, freely swivelling bit magazine for 12 bits ( $\frac{1}{4}$ ", 25 mm length) is integrated in the handle of the compact ratchet head.

### Swiveling bit magazine

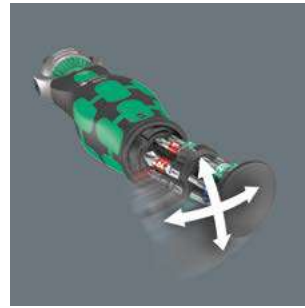

The swiveling bit magazine allows for the bits to be removed easily in almost any situation and cannot be lost. The bits are safely stored.

### Simple direction change



The Zyklop Pocket ratchet can be quickly and easily reversed for clockwise/counterclockwise rotation in any position using the knurl.

### Freely pivoting ratchet head

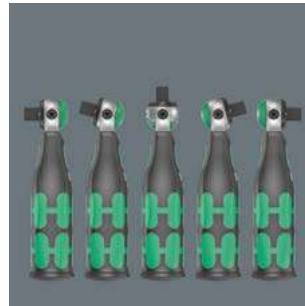

The ratchet head pivots freely and can be locked into any defined position by using the slide switch that is positioned on either side. It is even possible to work in very confined and difficult-to-access areas with enhanced hand clearance. The predefined locking at 0°, 15° and 90°, both to the right and left, ensure safe working without any slipping of the ratchet head.

### Belt holster



The robust holster can be attached to the belt as well as being Wera 2go compatible.

The ultimate Bicycle Set  
when you're out and about:  
lightweight, compact and  
with many functions.



- Innovative, extremely compact quadruple bit – only one bit for four different screw sizes
- Super space-saving solution, ideal for mobile use
- Compact, secure and very simple retainer in the Wera tyre levers
- The hexagon mounting of the tyre lever allows a torque of up to 10 Nm
- Significant weight savings and better overview of the tools when on tour



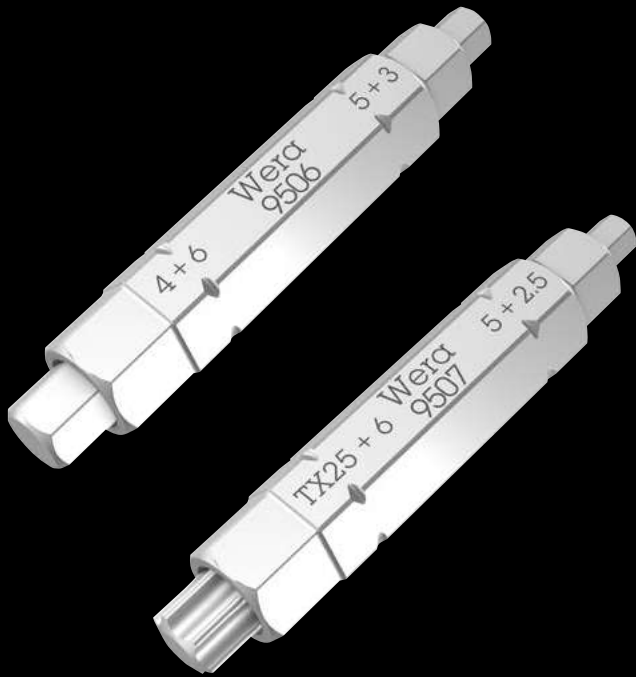

## Bicycle Set 15

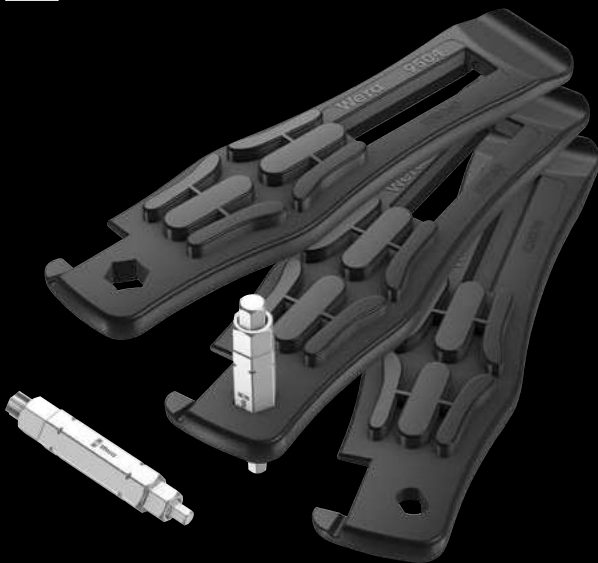

5-piece set

With the glass fibre reinforced plastic tyre levers, the tyres can be safely levered off the rim without damaging the rim.

Two 9504 tyre levers with 1/4" bit mounting

One 9505 tyre lever with valve ejector for French valves (Sclaverand) and bleeder valve for car valves

One bit 9506 (4-in-1) for hexagonal socket screws sizes 3.0; 4.0; 5.0; 6.0

One bit 9507 (4-in-1) for hexagonal socket screws sizes 2.5; 5.0; 6.0 and TORX® screws size TX 25

05004182001		
	9504	2x 105,0
	9505	1x 105,0
	9506	1x 3,0; 4,0; 5,0; 6,0x37
	9507	1x 2,5; 5; 6; TX 25x37

## Safely lever the tyres off of the rim



With the glass fibre reinforced plastic tyre levers, the tyres can be safely levered off the rim without damaging the rim. Lift off of the rim with one tyre lever, hook into a spoke and pull off the tyre with the second tyre lever. The two tyre levers can be clicked together and are therefore not lost individually.

## The 9504 tyre lever with bit mounting



The 1/4" hexagon mounting in the 9504 tyre lever can mount one 1/4" bit, allowing for easy connections.

## The 9505 tyre jack



The 9505 tyre lever can be used as a valve ejector for French valves (Sclaverand) and as a bleeder for car valves.

## The Wera 4-in-1 bits

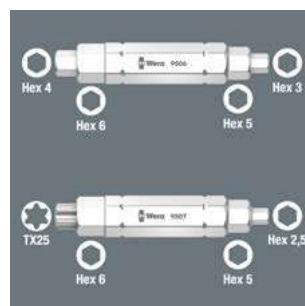

Four screw sizes can be operated with the 4-in-1 bits 9506 and 9507. The 4-in-1 bit 9506 for four sizes of hexagonal socket screws (3.0; 4.0; 5.0; 6.0), the 4-in-1 bit 9507 for three sizes of hexagonal socket screws (2.5; 5.0; 6.0) and one size of TORX® screw (TX 25). In order to use the larger profile,

continuously press against the spring tension while screwdriving so that the smaller profile is countersunk and the larger profile can be used.



The torque wrench that cannot be overtightened, with deactivation setting to use as a ratchet.



- Slip-over release mechanism – the set torque can never be overtightened
- Torque Lock function: The torque function can be deactivated and the tool can then be used as a standard ratchet for high loosening moments
- For controlled clockwise and counterclockwise torque operation – tightening and loosening with or without torque
- Easy setting and saving of the desired torque value with audible and tactile clicks when reaching the scale values
- After the target torque has been reached, the release angle is only 30°
- The fine tothing with 72 teeth allows for a low return angle of 5°



### Slide-over mechanism prevents application of excessive torques



The Safe-Torque A 1 torque wrench is equipped with a slide-over mechanism. Once the set torque value has been reached, the tool cannot be overtightened, so that excessive torque cannot be applied.

### Torque Lock function



The torque function can be deactivated.

### Torque Lock function



The Safe-Torque torque wrench can then also be used as a standard ratchet for high loosening moments.

### For clockwise and counterclockwise operation



The Safe-Torque torque wrench is suitable for clockwise and counterclockwise operation with a set torque. When the Torque Lock function is deactivated, tightening and loosening is enabled without torque.

### Easy torque setting



Easy setting and saving of the required torque with audible and tactile clicks on reaching the scale values.

## For 1/4" sockets



The Safe-Torque A 1 torque wrench has 1/4" square head mounting and is suitable for 1/4" sockets.

## Ball lock



The ball lock ensures secure seating of the sockets and accessories and therefore also reliable safety during screwdriving. A short press on the release button on the ratchet head and the ball lock is released.

## Space for more tools



The Wera Belts can be attached to the hook and loop fastener strips in the textile box of the sets Safe-Torque A 1 Set 1 and Safe-Torque A 1 Imperial Set 1, so more sockets and/or bit sockets can be stored and transported.



## Safe-Torque A 1 torque wrench with 1/4" square head drive, 2-12 Nm



**Application:** For controlled clockwise and counterclockwise torque operation; tightening and loosening with or without torque

**Torque range:** 2-12 Nm

**Suitable for:** 1/4" sockets

**Precision:** Accuracy  $\pm 10\%$  of the set value

**Design:** With 1/4" square head drive, torque wrench, disengageable torque function (Torque Lock function); 72 teeth; low return angle of 5°; easy setting and saving of the desired torque value, with audible and tactile locking when the scale values are reached, slip-over release mechanism when the set torque is reached

**Handle:** Ergonomic 2-component handle

		Nm	Nm	lbf. ft.	mm	mm	mm	mm	mm	mm	mm	mm	mm	mm
0507580001	1/4"	2-12	0,10	2-9	244	94	38,5	31,6	23,7	9 39/64"	3 45/64"	1 33/64"	1 15/64"	15/16"



10-piece 1/4" torque wrench set in a robust textile box; torque wrench with slide-over mechanism. Once the set torque has been reached, the tool cannot be overtightened, so that excessive torque cannot be applied.

Setting range of 2 to 12 Nm for controlled clockwise and counterclockwise torque operation. Easy setting and saving of the default value: The audible and tactile clicks on reaching the scale values facilitate the safe setting of the desired torque value. The Torque Lock function allows use as a standard ratchet without torque function. Thus also usable for applications with angles of rotation.

Max. breaking torque of the 1/4" square head as per DIN 3122. The return angle of only 5° allows the ratchet to be used even in confined spaces. Included are: Safe-Torque A 1 torque wrench, 1/4" square head, 2-12 Nm, 8 sockets with 1/4" drive and one short extension.

### Safe-Torque A 1 Set 1, 1/4" square head, 2-12 Nm



### Safe-Torque A 1 Imperial Set 1, 1/4" square head, 2-12 Nm



05075830001	
○	Safe-Torque A 1 1x 1/4", 2-12 Nm
●	8790 HMA 1x 5,5x23,0; 1x 6,0x23,0; 1x 7,0x23,0; 1x 8,0x23,0; 1x 10,0x23,0; 1x 11,0x23,0; 1x 12,0x23,0; 1x 13,0x23,0
○ □	8794 SA 1x 1/4"x75,0
□	K 240 1x 50,0x240,0

05075831001	
○	Safe-Torque A 1 1x 1/4", 2-12 Nm
●	8790 HMA 1x 3/16"x23,0; 1x 7/32"x23,0; 1x 1/4"x23,0; 1x 9/32"x23,0; 1x 5/16"x23,0; 1x 3/8"x23,0; 1x 7/16"x23,0; 1x 1/2"x23,0
○ □	8794 SA 1x 1/4"x75,0
□	K 240 1x 50,0x240,0



### Safe-Torque A 2 torque wrench with 1/4" hexagon drive, 2-12 Nm



**Application:** For controlled clockwise and counterclockwise torque operation; tightening and loosening with or without torque





















**Torque range:** 2-12 Nm

**Suitable for:** 1/4" bits with 1/4" external hexagon drive as per DIN ISO 1173-C 6.3 and E 6.3 and Wera connection series 1 and 4

**Precision:** Accuracy ± 10 % of the set value

**Design:** With 1/4" hexagonal socket drive, torque wrench, disengageable torque function (Torque Lock function); 72 teeth; low return angle of 5°; easy setting and saving of the desired torque value, with audible and tactile locking when the scale values are reached, slip-over release mechanism when the set torque is reached

**Handle:** Ergonomic 2-component handle

																						
		Nm	Nm	lbf. ft.	mm	mm	mm	mm	mm	mm	mm	mm	mm	mm	mm	mm	mm	mm	mm	mm	mm	mm
05075801001	1/4"	2-12	0,10	2-9	244	94	38,5	31,6	23,7	9 39/64"	3 45/64"	1 39/64"	1 15/64"	15/16"								

## Safe-Torque A 2 Set 1, 1/4" hexagonal, 2-12 Nm



23-piece set; in a surface-friendly, compact and extremely robust textile box. Small size and low weight for better mobility.

1 Safe-Torque A 2 torque wrench with 1/4" hexagonal socket drive, measuring range 2-12 Nm; for controlled clockwise and counterclockwise torque operation; tightening and loosening with or without torque, disengageable torque function (Torque Lock function); 72 teeth; low return angle of 5°; easy setting and saving of the desired torque value, with audible and tactile locking when the scale values are reached, slip-over release mechanism when the set torque is reached; ergonomic 2-component handle; 9 Zyklop sockets, 12 tough bits (1/4", 50 mm long), one connection part for sockets (1/4" external hexagon to 1/4" external square head)

05075832001	
●	Safe-Torque A 2 1x 1/4", 2-12 Nm
●	8790 HMA 1x 5,5x23,0; 1x 6,0x23,0; 1x 7,0x23,0; 1x 8,0x23,0; 1x 9,0x23,0; 1x 10,0x23,0; 1x 11,0x23,0; 1x 12,0x23,0; 1x 13,0x23,0
○ ○	870/1 1x 1/4"x25 <sup>1)</sup>
⊕	851/4 Z 1x PH 2x50
⊗	867/4 Z TORX® 1x TX 10x50; 1x TX 15x50; 1x TX 20x50; 1x TX 25x50; 1x TX 27x50; 1x TX 30x50
○	840/4 Z 1x 2,5x50; 1x 3,0x50; 1x 4,0x50; 1x 5,0x50; 1x 6,0x50
	K 240 1x 50,0x240,0

<sup>1)</sup> With friction ball; for manual nut spinner sockets

### For 1/4" bits



The Safe-Torque A 2 torque wrench has a 1/4" bit mounting with a strong permanent magnet and is suitable for bits with 1/4" external hexagon drive as per DIN ISO 1173-C 6.3 and E 6.3 and Wera connection series 1 and 4.

### Adapter for 1/4" sockets



With the 870/1 connector (1/4" external hexagon to 1/4" external square head) the Safe-Torque A 2 can also be used with 1/4" sockets.

## Finally developed: The interchangeable blade set for really tough screwdriving jobs.

- For loosening stubborn screw connections
- Manual impact wrench function can be switched on and off
- Hammer blow impulse is converted into a rotary movement with a loosening torque of approx. 25 Nm – without loss via a pound-thru blade
- Reversible functions: impact wrench and screwdriver
- Combines the advantages of manual impact wrenches, compact tools and screwdrivers with pound-thru blade





## Kraftform Kompakt 900 Set 1



Textile box with 1 impact screwdriver 921 and 18 impact screwdriver bits (70 mm length)

19-piece set

05018110001		
921	1x 1/4"x163,5	
851 S	1x PH 1x70; 1x PH 2x70; 1x PH 3x70	
855 S	1x PZ 1x70; 1x PZ 2x70; 1x PZ 3x70	
867 S TORX®	1x TX 15x70; 1x TX 20x70; 1x TX 25x70; 1x TX 30x70; 1x TX 40x70	
840 S Hex-Plus	1x 3,0x70; 1x 4,0x70; 1x 5,0x70; 1x 6,0x70	
800 S	1x 0,8x4,0x70; 1x 1,0x5,5x70; 1x 1,2x6,5x70	
K 120	1x 50,0x120,0	

## Kraftform Kompakt 900 Imperial Set 1



Textile box with 1 impact screwdriver 921 and 18 impact screwdriver bits (70 mm length)

19-piece set

05018111001		
921	1x 1/4"x163,5	
851 S	1x PH 1x70; 1x PH 2x70; 1x PH 3x70	
867 S TORX®	1x TX 15x70; 1x TX 20x70; 1x TX 25x70; 1x TX 30x70; 1x TX 40x70	
840 S Hex-Plus	1x 1/8"x70; 1x 5/32"x70; 1x 3/16"x70; 1x 1/4"x70	
868 S	1x # 1x70; 1x # 2x70; 1x # 3x70	
800 S	1x 0,8x4,0x70; 1x 1,0x5,5x70; 1x 1,2x6,5x70	
K 120	1x 50,0x120,0	

## 921 Kraftform Plus impact screwdriver – series 900



**Application:** Suitable for impact wrench bits with 1/4" external hexagon tip

**Design:** Switching function impact wrench/screwdriver; pound-thru blade; 1/4" hexagonal socket mounting, magnetic

**Handle:** Kraftform with anti-roll protection, multi-component

05018100001			
	mm	mm	mm
1/4"	163,5	6 7/16"	

## 868 S Square head socket bits for impact screwdrivers



**Application:** Square head socket screws; for use with impact screwdriver 921

**Drive:** 1/4" hexagonal

**Design:** Extra tough

	mm	mm
05018171001	# 1	70 2 3/4"
05018172001	# 2	70 2 3/4"
05018173001	# 3	70 2 3/4"

## 867 S TORX® bits for impact screwdrivers



**Application:** TORX® socket screws; for use with impact screwdriver 921

**Drive:** 1/4" hexagonal

**Design:** Extra tough

		□ mm	□ "
05018166001	TX 15	70	2 3/4"
05018167001	TX 20	70	2 3/4"
05018168001	TX 25	70	2 3/4"
05018169001	TX 30	70	2 3/4"
05018170001	TX 40	70	2 3/4"

## 851 S Phillips bits for impact screwdrivers



**Application:** Phillips screws; for use with impact screwdriver 921

**Drive:** 1/4" hexagonal

**Design:** Extra tough

		□ mm	□ "
05018160001	PH 1	70	2 3/4"
05018161001	PH 2	70	2 3/4"
05018162001	PH 3	70	2 3/4"

## 855 S Pozidriv bits for impact screwdrivers



**Application:** Suitable for Pozidriv screws; for use with impact screwdriver 921

**Drive:** 1/4" hexagonal

**Design:** Extra tough

		□ mm	□ "
05018163001	PZ 1	70	2 3/4"
05018164001	PZ 2	70	2 3/4"
05018165001	PZ 3	70	2 3/4"

## Combination tool

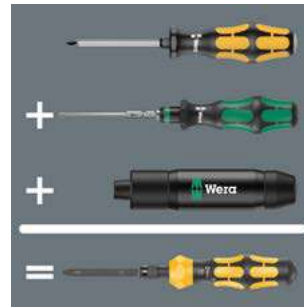

The 921 impact screwdriver combines the advantages of interchangeable blade sets, chiseldrivers and manual impact wrenches.

## Handle/interchangeable blade system



The robust bit mounting is suitable for bits with 1/4" external hexagon drive as per DIN ISO 1173-C 6.3 and E 6.3. The interchangeable blade system means low weight, reduced space requirement and high flexibility for the user.



## Impact wrench function can be switched on and off

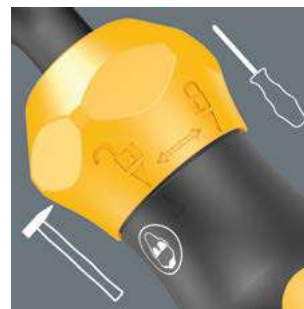

The manual impact wrench function can be switched on if required to loosen even stubborn screw connections.



## Loosening moment



With the impact wrench function switched on, the hammer blow impulse is converted into a rotary movement with a loosening moment of up to 25 Nm. Power transmission without loss via a pound-thru blade.

## 840 S Hex-Plus bits for impact screwdrivers



**Application:** Hexagonal socket screws; for use with impact screwdriver 921

**Drive:** 1/4" hexagonal

**Design:** Hex-Plus, extra tough

	⊙	⊙	⊏	⊏
	mm		mm	
05018150001	3,0		70	2 3/4"
05018151001	4,0		70	2 3/4"
05018152001	5,0		70	2 3/4"
05018153001	6,0		70	2 3/4"
05018154001		1/8"	70	2 3/4"
05018155001		5/32"	70	2 3/4"
05018156001		3/16"	70	2 3/4"
05018157001		1/4"	70	2 3/4"

## 800 S Slotted bits for impact screwdrivers



**Application:** Slotted screws; for use with impact screwdriver 921

**Drive:** 1/4" hexagonal

**Design:** Extra tough

	⊏	⊏	⊏	⊏
	mm	mm	mm	
05018140001	0,8	4,0	70	2 3/4"
05018141001	1,0	5,5	70	2 3/4"
05018142001	1,2	6,5	70	2 3/4"





Subtle ratchet sound from the handle.



### Ratchet function

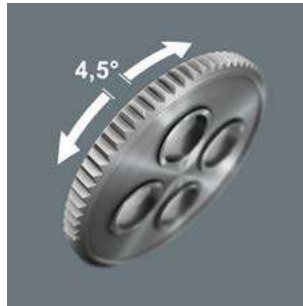

The integrated ratchet with fine toothings (80 teeth) and a return angle of 4.5° eases and accelerates screwdriving without having to reposition the tool.

### Ratchet mechanism in the handle

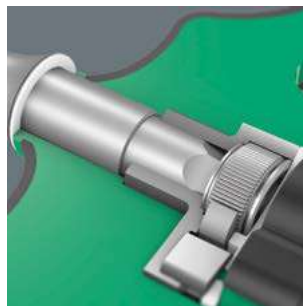

The ratchet mechanism of the 416 RA T-handle bitholding screwdriver is completely embedded in the handle. The compact shape of the tool allows convenient working.

### Reversible clockwise/counterclockwise

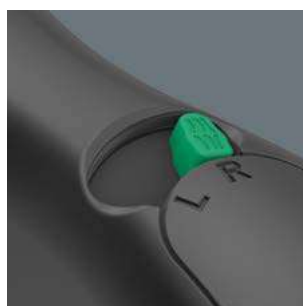

The change of direction can easily be made using the reversing lever.

- The integrated ratchet with fine toothing ensures fast and safe working
- Reversing lever for comfortable clockwise/ counterclockwise direction change
- Convenient working thanks to the ratchet mechanism fully embedded in the handle
- Ergonomic 2-component handle with finger handle recesses and pleasant surface feel for very high power transmission and fatigue-free working
- Fast-rotating sleeve for extremely high working speed
- Rapidaptor bitholding screwdriver with fast-rotating sleeve for lightning-fast bit changes and high working speeds
- For bits with 1/4" external hexagon drive as per DIN ISO 1173-C 6.3 and E 6.3



### Kraftform Kompakt 400 RA Set 1



17-piece set

Textile box with one 416 RA T-handle bitholding screwdriver with ratchet function and Rapidaptor quick-release chuck, 16 tough bits, 1/4", 89 mm length

05023471001		
●	416 RA	1x 1/4"x45
+	851/4 Z	1x PH 2x89; 1x PH 3x89
+	855/4 Z	1x PZ 2x89; 1x PZ 3x89
⊗	867/4 Z TORX®	1x TX 10x89; 1x TX 15x89; 1x TX 20x89; 1x TX 25x89; 1x TX 30x89; 1x TX 40x89
○	840/4 Z	1x 3,0x89; 1x 4,0x89; 1x 5,0x89; 1x 6,0x89; 1x 8,0x89
⊖	800/4 Z	1x 1,0x5,5x89
	K 120	1x 50,0x120,0

### Kraftform Kompakt 400 RA Imperial Set 1



17-piece set

Textile box with one 416 RA T-handle bitholding screwdriver with ratchet function and Rapidaptor quick-release chuck, 16 tough bits, 1/4", 89 mm length

05057473001		
●	416 RA	1x 1/4"x45
+	851/4 Z	1x PH 2x89; 1x PH 3x89
⊗	867/4 Z TORX®	1x TX 10x89; 1x TX 15x89; 1x TX 20x89; 1x TX 25x89; 1x TX 30x89; 1x TX 40x89
○	840/4 Z	1x 1/8"x89; 1x 3/32"x89; 1x 3/16"x89; 1x 7/32"x89; 1x 1/4"x89
□	868/4	1x # 2x89; 1x # 3x89
⊖	800/4 Z	1x 1,0x5,5x89
	K 120	1x 50,0x120,0



### 416 RA T-handle bitholding screwdriver with ratchet function and Rapidaptor quick-release chuck



**Application:** Suitable for bits with 1/4" external hexagon drive as per DIN ISO 1173-C 6.3 and E 6.3 and Wera connection series 1 and 4

**Design:** Ratchet with fine toothing integrated in the handle (80 teeth, return angle 4.5°) and clockwise/counterclockwise reversing lever; 1/4" hexagonal socket mounting with Rapidaptor technology with rapid-in, rapid-out, rapid-spin, chuck-all and single-hand function for bits with 1/4" external hexagon drive as per DIN ISO 1173-C 6.3 and E 6.3 and Wera series 1 and 4, magnetic

**Handle:** T-shape, 2 components, hole for hanging

	mm	mm	mm		
05023461001	1/4"	45	44	99	1 25/32"

### Fast-rotating sleeve



The fast-rotating sleeve allows the tool to be guided safely while screwdriving and increases the working speed.

### Chuck-all



The Rapidaptor quick-release chucks hold 1/4" DIN ISO 1173-C 6,3 and E 6,3 as well as Wera series 1 and 4 bits.

- The integrated ratchet with fine toothing ensures fast and safe working
- Reversing lever for comfortable clockwise/ counterclockwise direction change
- Convenient working thanks to the ratchet mechanism fully embedded in the handle
- Ergonomic 2-component handle with finger handle recesses and pleasant surface feel for very high power transmission and fatigue-free working
- Fast-rotating sleeve for extremely high working speed
- 1/4" socket mounting with secure ball lock



### Kraftform Kompakt 400 RA Set 2

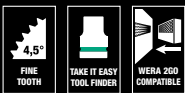

9-piece set in a robust textile box. One 411 A RA T-handle adapter screwdriver with ratchet function for 1/4" sockets. 8 sockets, 1/4", with "Take it easy" tool finder: Colour coding by size.

05023470001		
○	411 A RA	1x 1/4"x45
●	8790 HMA	1x 6,0x23,0; 1x 7,0x23,0; 1x 8,0x23,0; 1x 9,0x23,0; 1x 10,0x23,0; 1x 11,0x23,0; 1x 12,0x23,0; 1x 13,0x23,0
	K 120	1x 50,0x120,0

### Kraftform Kompakt 400 RA Imperial Set 2

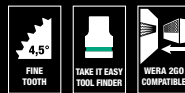

9-piece set in a robust textile box. One 411 A RA T-handle adapter screwdriver with ratchet function for 1/4" sockets. 8 sockets, 1/4", With "Take it easy" tool finder: Colour coding by size.

05057474001		
○	411 A RA	1x 1/4"x45
●	8790 HMA	1x 3/16"x23,0; 1x 7/32"x23,0; 1x 1/4"x23,0; 1x 9/32"x23,0; 1x 5/16"x23,0; 1x 3/8"x23,0; 1x 7/16"x23,0; 1x 1/2"x23,0
	K120	1x 50,0x120,0

## 411 A RA T-handle adapter screwdriver with ratchet function, 1/4"



**Application:** For 1/4" sockets as well as 1/4" connectors with square head drive, with ball lock

**Design:** Ratchet with fine toothing integrated in the handle (80 teeth, return angle 4.5°) and clockwise/counterclockwise reversing lever; fast-rotating sleeve

**Handle:** T-shape, 2 components, hole for hanging

		mm	mm	mm	
05023460001	1/4"	45	44	99	1 25/32"

## Fast-rotating sleeve



The fast-rotating sleeve allows the tool to be guided safely while screwdriving and increases the working speed.

## With 1/4" external square head tip



The 411 A RA T-handle is suitable for 1/4" sockets. The sockets are securely locked via the ball.

## 8790 C Impaktor Deep Set 1

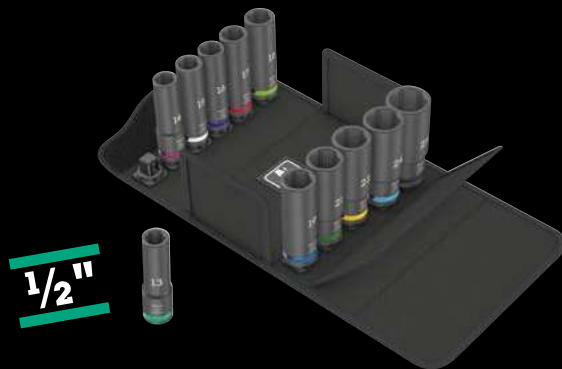

11-piece set; in a surface-friendly, compact and extremely robust textile box. Small size and low weight for better mobility.

11 Impaktor sockets with 1/2" drive; for use with electric or pneumatic wrenches with 12.5 mm = 1/2" drive; with hole for locking pin; long design for low-lying couplings and protruding thread rods; with hexagon profile; chromium molybdenum, matt-black. "Take it easy" tool finder. With colour coding by size as well as size stamping - for quick and easy identification of the required bit socket.

05004841001					
	8790 C Impaktor Deep	1x 13,0x83,0; 1x 14,0x83,0; 1x 15,0x83,0; 1x 16,0x83,0; 1x 17,0x83,0; 1x 18,0x83,0; 1x 19,0x83,0; 1x 21,0x83,0; 1x 22,0x83,0; 1x 24,0x83,0; 1x 27,0x83,0			

## 8790 C Impaktor Deep Set 1



For electric or pneumatic impact wrenches



The extremely robust forged design ensures that the Impaktor sockets have an above-average service life, even under extreme conditions.

## Long design



Due to the long design of the socket, screwdriving can also be achieved in small spaces. Fittings with protruding threaded rods are often also possible.

## Top quality roller cabinet exclusively for Tool Rebels.

- Exclusive roller cabinet in the Tool Rebel design
- Extremely robust thanks to a double-walled design
- With 7 drawers (5 flat, 2 high) – of which 2 flat drawers are equipped with foam inserts and tools
- Dimensions flat drawers (width x height x depth): 522 x 81 x 398 mm
- Dimensions high drawers (width x height x depth): 522 x 166 x 398 mm
- 100 % drawer pull-out with ball bearing telescopic slides, self-closing
- All drawers are elaborately and individually layered
- Minimum risk of tilting over thanks to the drawer stop – only one drawer can be opened, no simultaneous pull-out of multiple drawers
- High-quality, durable foam inserts without chemical vapours
- Optimum fit for the best possible removal of the tools from the foam inserts





## 9700 Tool Rebel roller cabinet 1



Includes the following foam inserts:

9710



9720

1/4"

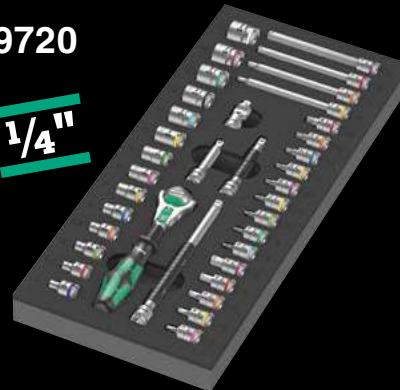

9731



9740



Exclusive roller cabinet in the Tool Rebel design. Five flat and two high drawers ensure efficient, mobile organization of tools and materials. Extremely robust design thanks to a double-walled design and the completely welded construction of the entire body. For daily hard work in the workshop. Equipped with four Wera foam inserts: 9710 foam insert screwdriver set 1, 9720 foam insert 8000 A Zyklop ratchet set 1, 9731 foam insert 6003 Joker ring spanner set 1, 9740 foam insert L-key set 1.

05150130001 1x 9700 Tool Rebel roller cabinet 1

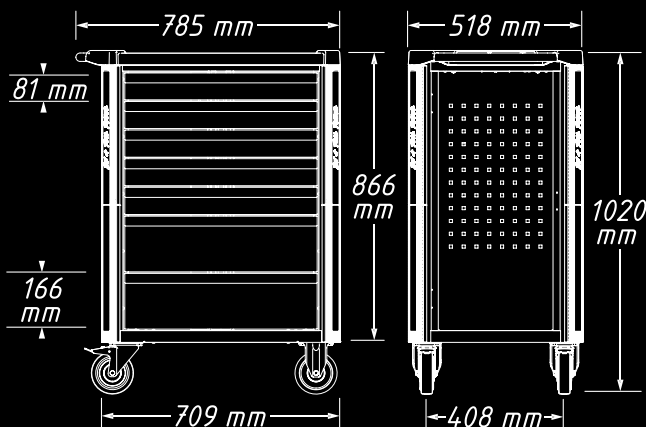

## Robust design for hard work in the workshop



The double-walled design and the completely welded construction make the Tool Rebel roller cabinet extremely robust. The optimized yielding edge protection on all four corners ensures reliable impact protection thanks to an internal cushioning action.

## Secure locking, smooth running



The two swivel castors are equipped with a double stop: The locked castor reliably prevents it from rolling away, the locked spindle carrier prevents the castors from turning unintentionally, e.g. on sloped surfaces. The oil- and acid-resistant elastic wheels ensure smooth running. A protective ring prevents the ingress of dirt and threads.

## Detailed locking concept for more security



The ergonomically arranged lateral position of the lock improves usability and protects the key and lock from damage. The extremely robust locking system protects the tools stored in the roller cabinet against unauthorized access. The central locking is completed by a cylinder lock. Two folding keys are included.

## High loads



The dynamic load of the roller cabinet is 540 kg, the static load is 1,000 kg and the drawer load is 25 kg.

## 9710 Foam insert screwdriver set 1



18-piece tool set (16 screwdrivers, 2 screw grippers) in a two-coloured foam insert for the Tool Rebel roller cabinet. Width x height x depth: without tools 344 x 30 x 392 mm, with tools 344 x 47 x 392 mm.

05150101001		
⊖	932 A	1x 1,0x5,5x100; 1x 1,2x7,0x125
⊕	350	1x PH 1x80; 1x PH 2x100; 1x PH 3x150
⊕	350 PH Stubby	1x PH 2x25
⊕	355	1x PZ 1x80; 1x PZ 2x100
⊖	335	1x 0,8x4,0x100; 1x 1,0x5,5x125
⊖	334	1x 1,2x6,5x150
⊖	335 Stubby	1x 1,0x5,5x24,5
⊕	2050 Micro	1x PH 0x40 <sup>1)</sup>
⊖	2035 Micro	1x 0,40x2,5x80
⊖	160 i VDE	1x 0,4x2,5x80 <sup>2)</sup> ; 1x 0,6x3,5x100 <sup>2)</sup>
	1441	1x 4,5-6,0x41,0
	1442	1x 6,0-8,5x41,0
	9810	1x 344,0x30,0x392,0

<sup>1)</sup> Size 0 modified according to JCIS 0 (Japanese Camera Industrial Standard)

<sup>2)</sup> without Lasertip

## 9711 Foam insert VDE screwdriver set 1

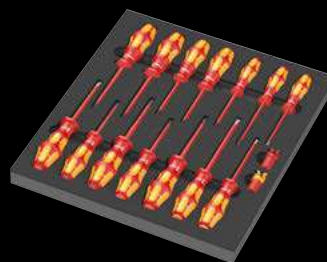

16-piece VDE-insulated screwdriver set (14 screwdrivers, 2 screw grippers) in a two-coloured foam insert for the Tool Rebel roller cabinet. Width x height x depth: without tools 344 x 30 x 392 mm, with tools 344 x 46 x 392 mm.

05150102001		
⊕	162 iS PH VDE	1x PH 1x80; 1x PH 2x100
⊕	165 iS PZ VDE	1x PZ 1x80; 1x PZ 2x100
⊕	165 i PZ/S VDE	1x # 2x100
⊖	160 i VDE	1x 0,4x2,5x80 <sup>1)</sup> ; 1x 0,8x4,0x100; 1x 1,0x5,5x125
⊖	160 iS VDE	1x 0,6x3,5x100
⊕	167 i TORX® VDE	1x TX 10x80; 1x TX 15x80; 1x TX 20x80; 1x TX 25x100; 1x TX 30x100
	1440	1x 4,5-6,0x41,0
	1442	1x 6,0-8,5x41,0
	9811	1x 344,0x30,0x392,0

<sup>1)</sup> without Lasertip

**Attention: The foam inserts do not fit in the previous model 05501051001 of the roller cabinet.**

- High-quality, durable foam insert without chemical vapours
- Optimum fit for the best possible removal of the tools from the foam insert
- Water- and oil-repellent, low maintenance and easy to clean
- Protection of the tool from dirt and impact

### 9712 Foam insert TORX® HF screwdriver set 1

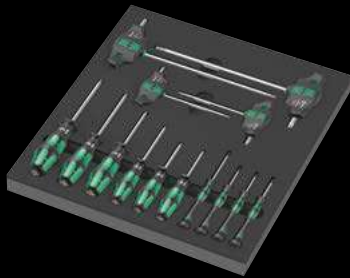
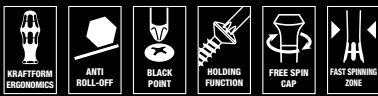

14-piece screwdriver set with holding function for TORX® screws in a two-coloured foam insert for the Tool Rebel roller cabinet. Width x height x depth (without tools): 344 x 30 x 392 mm, with tools 344 x 45 x 392 mm.

05150103001	
⊕	<b>367 TORX® HF</b> 1x TX 8x60; 1x TX 9x60; 1x TX 10x80; 1x TX 15x80; 1x TX 20x100; 1x TX 25x100
⊕	<b>2067 TORX® HF Micro</b> 1x TX 4x40; 1x TX 5x40; 1x TX 6x40; 1x TX 7x60
⊕	<b>467 TORX® HF</b> 1x TX 20x100; 1x TX 25x100; 1x TX 30x200; 1x TX 40x200
9812	1x 344,0x30,0x392,0

### 9713 Foam insert Hex screwdriver set 1

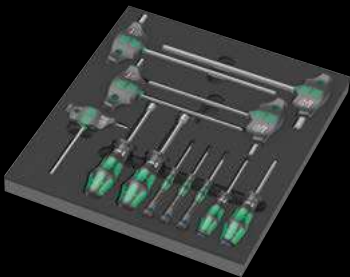

12-piece screwdriver set for hexagonal socket screws and external hexagon screws in a two-coloured foam insert for the Tool Rebel roller cabinet. Width x height x depth (without tools): 344 x 30 x 392 mm, with tools 344 x 45 x 392 mm.

05150104001	
○	<b>354</b> 1x 3,0x75; 1x 4,0x75
○	<b>2054 Micro</b> 1x 1,5x60; 1x 2x60; 1x 2,5x60
○	<b>454 HF</b> 1x 4x100; 1x 5x100; 1x 6x150; 1x 8x200; 1x 10x200
●	<b>395 HO</b> 1x 10,0x90; 1x 13,0x90
9813	1x 344,0x30,0x392,0

### 9720 Foam insert 8000 A Zyklop 1/4" ratchet set 1

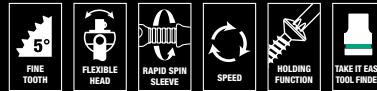

37-piece Zyklop ratchet set, 1/4", in a two-coloured foam insert for the Tool Rebel roller cabinet. Width x height x depth: without tools 172 x 30 x 392 mm, with tools 172 x 40 x 392 mm.

05150110001	
○	<b>8000 A</b> 1x 1/4"x152,0
●○	<b>8794 LA</b> 1x 1/4"x150,0
●○	<b>8794 SA</b> 1x 1/4"x75,0
●○	<b>8795 A</b> 1x 1/4"x35,5
●○	<b>8794 A</b> 1x 1/4"x56,0
●	<b>8790 HMA</b> 1x 4,0x23,0; 1x 4,5x23,0; 1x 5,0x23,0; 1x 5,5x23,0; 1x 6,0x23,0; 1x 7,0x23,0; 1x 8,0x23,0; 1x 9,0x23,0; 1x 10,0x23,0; 1x 11,0x23,0; 1x 12,0x23,0; 1x 13,0x23,0; 1x 14,0x23,0; 1x 15,0x23,0
⊕	<b>8767 A HF</b> 1x TX 8x28,0; 1x TX 9x28,0; 1x TX 10x28,0; 1x TX 15x28,0; 1x TX 20x28,0; 1x TX 25x28,0; 1x TX 27x28,0; 1x TX 30x28,0; 1x TX 40x28,0
○	<b>8740 A HF</b> 1x 3,0x28,0; 1x 4,0x28,0; 1x 4,0x100,0; 1x 5,0x28,0; 1x 5,0x100,0; 1x 6,0x28,0; 1x 6,0x100,0; 1x 8,0x28,0; 1x 8,0x100,0
9820	1x 172,0x30,0x392,0

### 9721 Foam insert 8000 B Zyklop 3/8" ratchet set 1

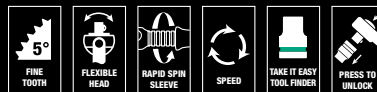

23-piece Zyklop ratchet set, 3/8", in a two-coloured foam insert for the Tool Rebel roller cabinet. Width x height x depth: without tools 172 x 30 x 392 mm, with tools 172 x 45 x 392 mm.

05150111001	
○	<b>8000 B</b> 1x 3/8"x199,0
●○	<b>8794 SB</b> 1x 3/8"x125,0
●○	<b>8794 LB</b> 1x 3/8"x200,0
●○	<b>8795 B</b> 1x 3/8"x50,0
●○	<b>8794 B</b> 1x 3/8"x76,0
●	<b>8790 HMB</b> 1x 6,0x29,0; 1x 7,0x29,0; 1x 8,0x29,0; 1x 9,0x29,0; 1x 10,0x29,0; 1x 11,0x29,0; 1x 12,0x29,0; 1x 13,0x29,0; 1x 14,0x29,0; 1x 15,0x29,0; 1x 16,0x30,0; 1x 17,0x30,0; 1x 18,0x30,0; 1x 19,0x30,0; 1x 20,0x30,0; 1x 21,0x30,0; 1x 22,0x30,0; 1x 24,0x32,0
9821	1x 172,0x30,0x392,0

## 9722 Foam insert 8000 C Zyklop 1/2" ratchet set 1

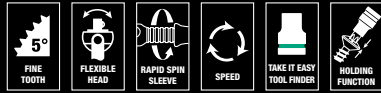

31-piece set Zyklop ratchet set, 1/2", in a two-coloured foam insert for the Tool Rebel roller cabinet. Width x height x depth: without tools 344 x 30 x 392 mm, with tools 344 x 51 x 392 mm.

05150112001		
⊙	8000 C	1x 1/2"x277,0
⊙⊙	8794 LC	1x 1/2"x250,0
⊙⊙	8794 SC	1x 1/2"x125,0
⊙⊙	8795 C	1x 1/2"x69,0
⊙⊙	8794 C	1x 1/2"x52,0
⊙	8790 HMC	1x 10,0x37,0; 1x 11,0x37,0; 1x 12,0x37,0; 1x 13,0x37,0; 1x 14,0x37,0; 1x 15,0x37,0; 1x 16,0x37,0; 1x 17,0x37,0; 1x 18,0x37,0; 1x 19,0x37,0; 1x 20,0x37,0; 1x 21,0x37,0; 1x 22,0x37,0; 1x 24,0x37,0; 1x 27,0x40,0; 1x 30,0x42,0; 1x 32,0x42,0
⊙	8740 C HF	1x 4,0x60,0; 1x 4,0x140,0; 1x 5,0x60,0; 1x 5,0x140,0; 1x 6,0x60,0; 1x 6,0x140,0; 1x 7,0x60,0; 1x 8,0x60,0; 1x 10,0x60,0
	9822	1x 344,0x30,0x392,0

## 9723 Foam insert Zyklop B 3/8" bit socket set 1



22-piece Zyklop bit socket set, 3/8", in a two-coloured foam insert for the Tool Rebel roller cabinet. Width x height x depth: without tools 172 x 30 x 392 mm, with tools 172 x 39 x 392 mm.

05150113001		
⊙⊙	8784 B1	1x 1/4"x3/8"x44,0
⊙	8767 B HF	1x TX 15x35,0; 1x TX 20x35,0; 1x TX 25x35,0; 1x TX 25x107,0; 1x TX 27x35,0; 1x TX 27x107,0; 1x TX 30x35,0; 1x TX 30x107,0; 1x TX 40x35,0; 1x TX 40x107,0
⊙	8740 B HF	1x 4,0x35,0; 1x 4,0x107,0; 1x 5,0x35,0; 1x 5,0x107,0; 1x 6,0x35,0; 1x 6,0x107,0; 1x 7,0x38,5; 1x 8,0x38,5; 1x 8,0x100,0; 1x 10,0x38,5; 1x 10,0x100,0
	9823	1x 172,0x30,0x392,0

## Safe storage and quick overview

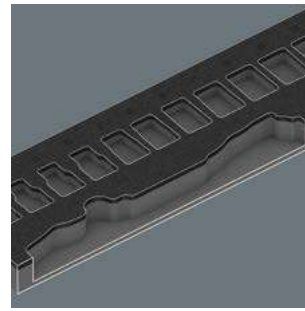

The tools sit securely in the foam thanks to precise contour cutouts, but are easy to remove. The carefully designed arrangement of the tools ensures space-saving storage and quick access to each tool.

## 9730 Foam insert 6000 Joker set 1



11-piece 6000 Joker ring ratchet spanner set, in a two-coloured foam insert for the Tool Rebel roller cabinet. Width x height x depth: without tools 172 x 30 x 392 mm, with tools 172 x 47 x 392 mm.

05150120001		
	6000 Joker	1x 8x144; 1x 10x159; 1x 11x165; 1x 12x170,7; 1x 13x177; 1x 14x188; 1x 15x200; 1x 16x212; 1x 17x224; 1x 18x235; 1x 19x246
	9830	1x 172,0x30,0x392,0

## 9731 Foam insert 6003 Joker set 1

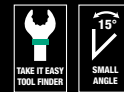

18-piece 6003 Joker ring spanner set, 1 Kraftform bottle opener, in a two-coloured foam insert for the Tool Rebel workshop trolley. Width x height x depth: without tools 344 x 30 x 392 mm, with tools 344 x 58 x 392 mm.

05150121001		
	6003 Joker	1x 6x105; 1x 7x110; 1x 8x115; 1x 9x120; 1x 10x125; 1x 11x135; 1x 12x148; 1x 13x160; 1x 14x167; 1x 15x174; 1x 16x182; 1x 17x190; 1x 18x210; 1x 19x230; 1x 20x230; 1x 21x260; 1x 22x260; 1x 24x280
	Bottle opener	1x 145
	9831	1x 344,0x30,0x392,0

## 9732 Foam insert 6004 Joker set 1



5-piece 6004 Joker self-setting spanner set, in a two-coloured foam insert for the Tool Rebel workshop trolley. Width x height x depth: without tools 172 x 30 x 392 mm, with tools 172 x 35 x 392 mm.

05150122001	
	6004 Joker XS 1x 7-10 ( $1/4''$ - $3/8''$ )x117
	6004 Joker S 1x 10-13 ( $7/16''$ - $1/2''$ )x154
	6004 Joker M 1x 13-16 ( $1/2''$ - $5/8''$ )x188
	6004 Joker L 1x 16-19 ( $5/8''$ - $3/4''$ )x224
	6004 Joker XL 1x 19-24 ( $3/4''$ - $15/16''$ )x256
	9832 1x 172,0x30,0x392,0

## 9740 Foam insert L-key set 1

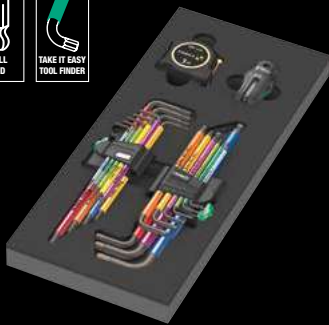
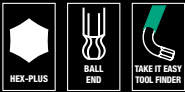

18-piece L-key set (hexagonal socket screws and TORX® screws) plus one Wera magnet and one Stabila pocket tape measure (3 m), in a two-coloured foam insert for the Tool Rebel roller cabinet. Width x height x depth: without tools 172 x 30 x 392 mm, with tools 172 x 44 x 392 mm.

05150140001	
	1x 950/9 Hex-Plus Multicolour 1
○	950 SPKL Multicolour 1x 1.5x90; 1x 2.0x101; 1x 2.5x112; 1x 3.0x123; 1x 4.0x137; 1x 5.0x154; 1x 6.0x172; 1x 8.0x195; 1x 10.0x224
	1x 967/9 TX XL Multicolour 1
⊖	967 SXL TORX® Multicolour 1x TX 8x90; 1x TX 9x101; 1x TX 10x112
⊖	967 SPKXL TORX® Multicolour 1x TX 15x123; 1x TX 20x137; 1x TX 25x154; 1x TX 27x172; 1x TX 30x195; 1x TX 40x224
	1x 9500 1x 48.0
	1x STABILA® BM 100 Pocket tape, metric scale, 3 m, item 19570 1x 3000,0
	1x 9840 1x 172,0x30,0x392,0

## Two-coloured foam insert



After removing the tool the light grey second foam becomes visible and therefore missing tools are quickly identified.

## 9750 Foam insert Kraftform Kompakt and Tool-Check PLUS set 1



57-piece tool set (1 Tool-Check PLUS (39 pieces), 1 Kraftform Kompakt 60 (16 pieces) and one bitholding screwdriver with flexible shaft), in a two-coloured foam insert for the Tool Rebel workshop trolley. Width x height x depth: without tools 172 x 30 x 392 mm, with tools 172 x 59 x 392 mm.

05150150001	
	1x Tool-Check PLUS
○	8001 A 1x $1/4''$ x87.0
●	813 1x $1/4''$ x78
⊖	889/4/1 K 1x $1/4''$ x50
○	870/1 1x $1/4''$ x25 <sup>1)</sup>
●	8790 HMA 1x 5.5x23.0; 1x 6.0x23.0; 1x 7.0x23.0; 1x 8.0x23.0; 1x 10.0x23.0; 1x 12.0x23.0; 1x 13.0x23.0
+	851/1 TZ 2x PH 1x25; 3x PH 2x25; 1x PH 3x25
+	855/1 TH 1x PZ 1x25; 3x PZ 2x25; 1x PZ 3x25
⊖	867/1 TZ TORX® 1x TX 10x25; 1x TX 15x25; 1x TX 20x25; 1x TX 25x25; 1x TX 30x25; 1x TX 40x25
⊖	867/1 Z TORX® B0 1x TX 10x25; 1x TX 15x25; 1x TX 20x25; 1x TX 25x25; 1x TX 30x25
○	840/1 Z 1x 3.0x25; 1x 4.0x25; 1x 5.0x25; 1x 6.0x25; 1x 8.0x25
⊖	800/1 TZ 1x 1.0x5.5x25
	1x Kraftform Kompakt 60
●	816 R 1x $1/4''$ x119
+	851/4 Z 1x PH 1x89; 1x PH 2x89; 1x PH 3x89
+	855/4 Z 1x PZ 1x89; 1x PZ 2x89; 1x PZ 3x89
⊖	867/4 Z TORX® B0 1x TX 10x89; 1x TX 15x89; 1x TX 20x89; 1x TX 25x89; 1x TX 30x89
⊖	800/4 Z 1x 1.0x5.5x89
○	840/4 Z 1x 3.0x89; 1x 4.0x89; 1x 5.0x89; 1x 6.0x89
	Hook and Loop Fastener Strip 70 1x 50.0x70.0
	1x 393 S Bitholding screwdriver extra slim with flexible shaft
●	1x $1/4''$ x173,5
	1x 9850 1x 172,0x30,0x392,0

## 9780 Foam insert KNIPEX pliers set 1



3-piece pliers set (1x KNIPEX combination pliers, chrome-plated, 1x KNIPEX Cobra® high-tech water pump pliers, chrome-plated, 1x KNIPEX high leverage diagonal cutter, chrome-plated), in a two-coloured foam insert for the Tool Rebel roller cabinet. Width x height x depth: without tools 172 x 30 x 392 mm, with tools 172 x 38 x 392 mm.

05150180001		
	KNIPEX Combination Pliers 03 05 180	1x 180
	KNIPEX Cobra® High-Tech Water Pump Pliers 87 05 250	1x 250
	KNIPEX High Leverage Diagonal Cutter 74 05 160	1x 160
	9880	1x 172,0x30,0x392,0

## 9781 Foam insert KNIPEX pliers set 2

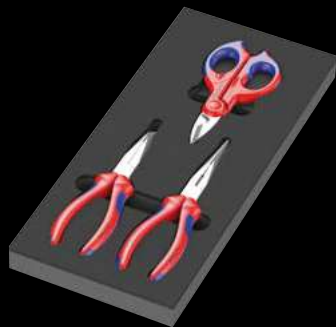

3-piece pliers set (1 KNIPEX nose cutting pliers (stork beak pliers), 1 KNIPEX mechanics' pliers, 1 KNIPEX electricians' shears), in a two-coloured foam insert for the Tool Rebel roller cabinet. Width x height x depth: without tools 172 x 30 x 392 mm, with tools 172 x 38 x 392 mm.

05150181001		
	KNIPEX Snipe Nose Cutting Pliers (Stork Beak Pliers) 26 15 200	1x 200
	KNIPEX Mechanics' Pliers 38 25 200	1x 200
	KNIPEX Electricians' Shears 95 05 155	1x 155
	9881	1x 172,0x30,0x392,0

## 9782 Foam insert hammer set 1



6-piece tool set (1 PICARD® riveting hammer (500 gr), 4 colour-coded RENN-STEIG parallel pin punches, 1 RENNSTEIG flat cold chisel), in a two-coloured foam insert for the Tool Rebel roller cabinet. Width x height x depth: without tools 172 x 30 x 392 mm, with tools 172 x 35 x 392 mm.

05150182001		
	PICARD® riveting hammer 500 g, 0000101-500	1x 500,0
	○ RENNSTEIG parallel pin punches Exclusive	1x 452 003 6 RC, 3,0x150; 1x 452 004 6 RC, 4,0x150; 1x 452 006 6 RC, 6,0x150; 1x 452 008 6 RC, 8,0x150
	● RENNSTEIG flat cold chisel 310 250 1	1x 25,0x13,0x23,0
	9882	1x 172,0x30,0x392,0

## 9783 Foam insert PFERD file set 1

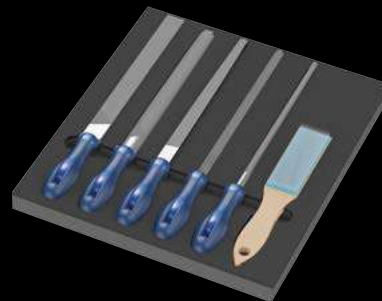

6-piece file set (1 PFERD file square PF1142 250 H2, 1 PFERD file half-round pointed PF1152SP 250 H2, 1 PFERD file round PF1162 250 H2, 1 PFERD file hand PF1112 250 H2, 1 PFERD file three square PF 1132 250 H2, 1 PFERD scratch brush HBF ST 0.15), in a two-coloured foam insert for the Tool Rebel roller cabinet. Width x height x depth: without tools 344 x 30 x 392 mm, with tools 344 x 42 x 392 mm.

05150183001		
	PFERD machinist's file square PF1142 250 H2	1x 250
	PFERD machinist's file half-round pointed 1152SP 250 H2	1x 250
	PFERD machinist's file round 1162 250 H2	1x 250
	PFERD machinist's file hand 1112 250 H2	1x 250
	PFERD machinist's file three square 1132 250 H2	1x 250
	PFERD scratch brush HBF steel wire Ø 0.15	1x 232
	9883	1x 344,0x30,0x392,0



Wera Werkzeuge GmbH  
Korzter Straße 21-25  
D-42349 Wuppertal

Phone: +49 (0)202/40 45-0  
Fax: +49 (0)202/40 45 276  
E-Mail: [info@wera.de](mailto:info@wera.de)  
[www.wera.de](http://www.wera.de)

Wera Tools (UK) LTD.  
Railway View  
Clay Cross  
Chesterfield  
Derbyshire, S45 9FR

+44 (0)1246 / 277756  
[queries@wera-tools.co.uk](mailto:queries@wera-tools.co.uk)  
[www.wera-tools.co.uk](http://www.wera-tools.co.uk)

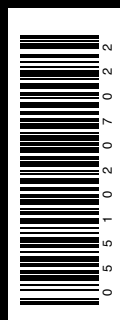

No liability for printing errors or mistakes  
shall be assumed.