

go-e



Installation and operating manual

go-e Charger CORE

Stationary wallbox/charging station for electric vehicles,
according to EN IEC 61851-1:2019,
valid for article numbers: CH-CORE-001, FR-CORE-T2S-001

V 1.01

Content



Discover the go-e YouTube Channel
Here you can find HOW-TO videos and product videos. Our
videos are available with subtitles in different languages!

- 1 Important symbols
page 4
- 2 Thank you for your purchase decision
page 4
- 3 Product overview
page 5
- 4 Safety & compliance notes
page 10
- 5 Technical specification
page 17
- 6 Scope of delivery
page 20
- 7 Installation process
page 22
- 8 Commissioning
page 36
- 9 Charging Process
page 42
- 10 LED status display / Troubleshooting
page 46
- 11 Smart features
page 50
- 12 Guarantee, warranty and exclusions
page 54
- 13 go-e Charger CORE with Non-removable Battery (CR2477)
page 55
- 14 CE Declaration of Conformity
page 55
- 15 Contact and support
page 56

1. Important symbols



Safety Warning: a hazardous situation may result in damage to health, fatal injuries or damage to property if the instruction is not followed.



Useful Tip: special information to keep in mind



The activity may only be carried out by a qualified electrician.

2. Thank you for your purchase decision

With the go-e Charger CORE, you have chosen a product that ensures intelligent and reliable charging. The go-e Charger CORE offers the smart features you are used to from go-e, such as PV surplus charging or charging with flexible energy tariffs. The wallbox also enables data exchange via the most common communication interfaces and is in accordance with ISO 15118 V2X ready* and Plug&Charge ready*. Even more convenient and efficient charging at an excellent price-performance ratio. Scalable thanks to load balancing and open interfaces. Easy to install, convenient to use and always intelligently connected. The go-e Charger CORE features a permanently attached charging cable with a type 2 plug. The go-e Charger CORE

offers the same range of functions as the go-e Charger PRO with just one difference - the CORE's electricity meter is not certified in accordance with the MID directive. However, the charged kWh are also displayed directly via the LED display integrated on the front of the charging station. Alternatively, you can also view this via the app.

We wish you lots of fun with the go-e Charger and enough electricity at all times.

Your

*Functionality is prepared on the hardware side and will be provided as a feature at a later stage via software update.

3. Product overview

The go-e Charger CORE is a smart charging device for electric vehicles.

It has a host of intuitive features to level up the charging experience.

Best of all, the charger is easy to install!

Variants

The go-e Charger CORE series is similar to the PRO series but is not MID certified. It consists of the following variants with the additional differences described below:



Article number	Product name	Description
CH-CORE-001	go-e Charger CORE	CORE charger with integrated charging cable and type 2 plug
FR-CORE-T2S-001	go-e Charger CORE T2S	CORE charger with integrated charging cable and type 2 plug with shutter; is only included in deliveries to France

The name "CORE" is used for short to refer to all variants. The information in this manual applies to all variants unless stated otherwise.

3. Product overview

Power supply

The go-e Charger CORE is powered by your existing home or business AC electricity network. The charger supports single-phase and three-phase power inputs. For installations with a solar panel supplying additional electricity, the CORE automatically detects the supply and switches phases accordingly. Once installed, the CORE is permanently connected to your AC supply network.

Power delivery

The CORE delivers AC current to the vehicle.

By default, the CORE is limited to a maximum current of 16 Amps. This means a power delivery of 11 kW when connected to a three-phase supply and 3.7 kW when connected to a single-phase supply.

commissioning, up to a maximum of 32 Amps.

The relationship between current and power is shown below as an example, assuming a 230 V supply.

The CORE can support up to a maximum of 22 kW power delivery.

 The default current limit can be changed by a qualified electrician during installation and

Current supply	Power with 1 phase supply	Power with 3 phase supply
16 Amps	3.7 kW	11 kW
32 Amps	7.4 kW	22 kW

 Please follow the registration and installation regulations for your region prior changing the default power.

3. Product overview

Construction

The go-e Charger CORE consists of two units:

- Charging unit
- Wall mount unit

The **charging unit** includes a permanently attached 6 meter charging cable and Type 2 vehicle plug. In contrast to chargers of the PRO series, the CORE does not have a MID-compliant but a simple electricity meter. On the front is a screen that displays electricity consumption for each charging session as well as across the charger lifetime.

The **wall mount unit** is where the installation work takes place. Here, the connection to the AC electrical supply is made. If you have ethernet or other data cables, they can also be wired here. Once installed the charging body is simply docked onto the wall mount. You're ready to go!

Section 7 describes the installation in a few easy steps.



3. Product overview



- a** RFID token
- b** Reset card
- c** Charging Unit with permanently attached charging cable and type 2 plug (6 m)
- d** RFID reader
- e** LED ring
- f** Display of the charged kWh

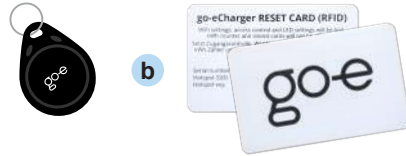

3. Product overview

Connectivity

The CORE offers a range of intuitive features that save you money and time. You can also easily integrate with other energy services.

To do this, the CORE offers ethernet, wireless and cellular connectivity to the internet.

Not enough? The CORE supports an alphabet soup of open and documented

communication protocols, including OCPP 1.6j, HTTP API (cloud and local), Modbus TCP and MQTT.

The list of smart features is being continually updated. To access them all, download the go-e App or use the **go-e Portal**.

Section 11 describes the smart features in detail.

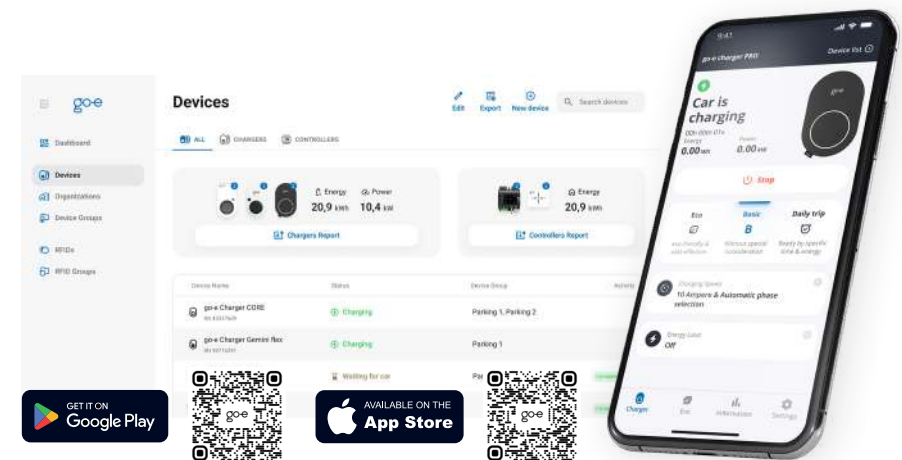

Accessories

Further accessories to be used in conjunction with the go-e Charger CORE can be found at the go-e Webshop or at your nearest go-e partner.



4. Safety & compliance notes



Download the data sheet:
www.go-e.com

Instructions and downloads

Note before installation and commissioning



Observe all safety regulations and instructions in this manual! Read the manual and data sheet carefully and keep them for future reference. The documents are intended to help you:

- To use the product safely and properly
- Increase the durability and reliability
- To avoid damage to the device or property
- To prevent a threat to life and limb

General safety regulations

The go-e Charger CORE may only be used for charging battery electric vehicles (BEV) and plug-in hybrids (PHEV) with the adapters and cables intended for this purpose.

Disregarding the safety regulations can have serious consequences. go-e GmbH declines any liability for damage caused by disregarding the operating instructions, safety regulations or warnings on the unit.

In case of unusual heat development, do not touch the go-e Charger CORE or the charging cable and stop the charging process as soon as possible. If the plastic is discoloured or deformed, contact customer support.

Never cover the go-e Charger during charging. Heat build-up can lead to fire.

Persons wearing electronic implants should keep at least 60 cm away from

the go-e Charger due to electromagnetic fields.

The go-e Charger CORE has the communication interfaces WiFi 802.11b/g/n 2.4GHz, LTE-FDD*, GPRS*, EDGE* and RFID. WiFi is operated on a frequency of 2.4GHz, channels 1-13 with the frequency band 2412-2472Mhz. The maximum transmission power of the WiFi is 20dBm. LTE is operated on FDD bands 1, 3, 7, 8 and 20 with a maximum transmission power of 23dBm. GPRS and EDGE are operated on 900 and 1800MHz at a maximum transmission power of 35dBm. RFID is operated on a frequency of 13.56MHz with a maximum radiated power of 60dBµA/m at 10m.

Product must be operated within the specified operating conditions - including voltages, currents, temperatures and other environmental conditions.

4. Safety & compliance notes

Country-Notes

National and local installation regulations must be observed.

Depending on the country, the requirements of the authorities and electricity grid operators must be observed, such as the obligation to register or obtain approval for EV charging stations or the limitation of single-phase charging. Contact your grid operator/electricity provider to find out whether the go-e Charger requires registration or approval and whether other limitations must be observed.

France, Portugal, Denmark, Italy, Spain, Singapore, Sweden: The installer is obliged to instruct the user and to inform that uninstructed persons of groups BA1 (ordinary person - neither skilled nor instructed), BA2 (children), and BA3 (disabled persons) should not have access to the product. Also the product should be mounted at a suitable location between 1.00 and 1.45 m above the ground.

Netherlands & Italy: A mechanical switching device must be installed directly upstream of the charger, to provide iso-

lation in case of a fault in the Charger. The go-e Charger CORE satisfies the requirements of an Overvoltage Category 3 (OVC 3) device. This shall be achieved with a shunt-trip installed outside the charger between the charger and electricity supply from the grid. The installation is required to be performed by the installer and can be done at the same time as installation of the charger.

France: The go-e Charger CORE T2S features an Amphenol charging cable with an integrated shutter in the connector. The shutter acts as a protective cover for the electrical pins within the connector. It is primarily designed to ensure a safe connection during the electric vehicle charging process. The shutter is a physical component of the Amphenol vehicle connector. When the connector is properly inserted into the charging inlet, the shutter moves out of the way, allowing the electrical pins to make contact. Upon disconnection, the shutter returns to its original position, once again covering the electrical pins. This mechanism is designed to protect the pins when the cable is not in use.

Type label

Observe the information on the type label of the go-e Charger CORE.

- 1 Manufacturer's address
- 2 Product name
- 3 Article number
- 4 Default current & max output
- 5 Nominal voltage 1 / 3 phase
- 6 Nominal frequency
- 7 Operating temperature
- 8 EVSE serial number

4. Safety & compliance notes

9 Date of manufacture

go-e GmbH 
1 Satellitenstraße 1
Feldkirchen in Kärnten
Austria 9560

2 **go-e Charger CORE**
3 CH-CORE-001
Cable 6m 22kW IEC 61439-7

4 **default current** AC 16A 11kW
output max power 22kW
output current range 6A - 32A
voltage 5 3X230(400)V
6 **frequency** 1φ/3φ 50Hz
7 **temperature** -25°C to +40°C

8 **serial number** 
CR-10-6XXXX X

9 **manufactured** 
on 2025/08 **Product ID**

MADE IN AUSTRIA

go-e Charger CORE



Variable data is marked in red and is replaced during production by device-specific data.

4. Safety & compliance notes

Electrical protective measures



High voltage - danger to life! Never use the go-e Charger PRO if the enclosure, charging plug or any cables are damaged or open.

The charging unit may only be removed from the wall mount unit by a qualified electrician. Before carrying out any maintenance or disconnection work, de-energise the circuit.



An electric shock can be fatal. Do not reach into the charger or charging plug by hand or with technical aids.

Installation must be carried out in accordance with local, regional and national regulations.

Any information regarding electrical installation is intended exclusively for a qualified electrician whose training allows all electrical work to be carried out in accordance with the applicable national regulations.

The go-e Charger PRO is to be permanently connected to an AC electricity supply network.

Make sure that the electricity supply cable leading to the charger is properly installed and undamaged.

Before installation, inspect the product for visible damage, or unauthorised opening of the enclosure. In case of findings, do not install and contact technical support.

The go-e Charger PRO is classed as a Mode 3 charging device. Transition to other charging modes is not allowed.

Before carrying out electrical connection work, you need to de-energise the circuit.

The PRO is classified as class III equipment in terms of protection against electric shock.

Residual Current Protective Devices

The product must be installed by a qualified electrician.

installation at least type A ($I_{\Delta n} = 20\text{mA AC}$). IEC 60364-7-722 or the corresponding national installation regulations may contain additional requirements for the installation.

A miniature circuit breaker is not part of the PRO and must be connected upstream by a qualified electrician.

All electrical equipment installed in conjunction with the go-e Charger PRO (such as cables, circuit breakers and protective devices) must be correctly specified by the installer and checked to be in good working order.

The PRO has a built-in residual current protection module with residual current detection ($I_{\Delta n} = 20\text{mA AC}$ and 6 mA DC), a separate residual current circuit breaker must be connected upstream of the

4. Safety & compliance notes

Environmental conditions

Observe the permissible ambient conditions from the data sheet.

The go-e Charger CORE is surface mounted to walls or compatible poles. The mounting surface must cover the entire back surface of the charger. The charger is not to be floor or ground mounted.

The charger is suitable for indoor and outdoor use:

- A location without direct sunlight is recommended.

Ground Check

The go-e Charger PRO has a safety function called „ ground check“, which prevents charging in TT/TN power grids (common in most European countries) if the power connection is not grounded. This function is activated by default. It may only be deactivated via the go-e app

Charging Plug

The charging cable and charging plug is permanently attached to the go-e Charger PRO CABLE and CABLE ME.

Do not use the charger if either the electricity supply cable or charging cable is damaged or open.

Install the provided plug holder to keep the type 2 plug secure.

Never use the charging plug in wet or dirty condition. The plug contacts must be clean and dry before use.

- The CORE is only suitable for charging gassing vehicle traction batteries in well-ventilated rooms.
- The unit must not be operated indoors if there is an increased danger from ammonia gases.

The CORE should not be operated in the immediate vicinity of flammable or explosive substances, running water or heat-emitting equipment.

if you are sure that the power grid does not have an earth connection (IT grid, e.g. in many regions of Norway) so that charging can also take place here. The PRO visualises a deactivated „ ground check“ by 4 red LEDs (3, 6, 9, 12 o'clock).

Only remove the plug once charging is stopped and the car has unlocked the charging plug. Grip the charging plug to remove from your vehicle. Never pull on the cable.

Adaptors, conversion adaptors and cord extension sets are not allowed to be used.

Check that the charging cable is removed from car and safely stowed before driving away.

4. Safety & compliance notes

Maintenance & Repair

Any modification or repair of the hardware or software of the go-e Charger CORE may only be carried out by specialist personnel of go-e GmbH.

For safety reasons, the disassembly of an presumed defective, permanently installed go-e product may only be carried out by a qualified electrician.

Before dismantling an presumed defective product, always contact go-e's technical customer support and wait for its decision on the next steps.

A tamper protection label is fitted on the rear of the Charging Body. Removing and damaging any labels attached to the

go-e Charger CORE or opening the Charging body will result in the loss of any liability by go-e GmbH.

Modification or opening the CORE charging body will result in the invalidation of the product warranty.

The go-e Charger CORE is maintenance-free.

The device may be cleaned with a damp cloth. Do not use cleaning agents or solvents. Do not clean the device with a high-pressure cleaner or under running water.

4. Safety & compliance notes

Disposal

According to directive 2012/19/EU (WEEE directive), electrical devices must not be disposed of in household waste after the end of use. Take the product in accordance with national legal requirements to a collection point specially set up for waste electrical equipment.

Dispose of the product packaging properly so that it can be recycled.

Battery Disposal: The battery must not be disposed of with household

Legal

The copyright for these operating instructions is owned by go-e GmbH.

All texts and illustrations correspond to the technical status at the time of writing. go-e GmbH reserves the right to make unannounced changes. The con-

tent of the operating instructions does not justify any claims against the manufacturer. Pictures are for illustration purposes and may differ from the actual product.

waste. This product contains a built-in lithium-ion battery that is not accessible to the user or installer. At the end of the product's life, the battery must be removed by a qualified service provider before disposal of the device. The removed battery must be disposed of separately at designated collection points or returned to retailers free of charge. Proper disposal helps prevent harm to the environment and human health and enables valuable materials to be recovered.

5. Technical specification

Properties		CORE
Dimensions (B x H x D) (without cable)		Approx. 18.6 x 29.7 x 9.9 cm
Weight (including cable)		Approx. 5.25 kg
Charging cable	Length	6 m
	Cross section area	5 x 6 mm ² + 1 x 0.5 mm ²
Grid connection cable	Type	customer-supplied
	Permissible cross sectional area	3 x 1.5 mm ² - 5 x 10 mm ²
	Permissible diameter	10 mm - 20 mm
Electrical supply		Single-phase or three-phase
Nominal frequency		50 Hz
Rated voltage		230 V - 240 V (single-phase) 400 V - 415 V (three-phase)
Maximum rated current		16 A (single-phase / three-phase) 32 A (single-phase / three-phase)
Maximum charging power		22 kW (32 A, three-phase)
Power grid types		TT / TN / IT
Standby power consumption		3.5 W

Environmental conditions	CORE
Installation site	Indoors and outdoors
Operating temperature	-25 °C to +40 °C
Storage temperature	-40 °C to +85 °C
Maximum operating altitude	2.000 m above sea level
Maximum relative humidity	<95 % (not condensing)

5. Technical specification

Communication interfaces and protocols	CORE
RFID	13.56 MHz
WiFi	802.11b/g/n 2.4 GHz frequency band 2412-2472 Mhz
Bluetooth	BLE ready (2.4 GHz)
Cellular	LTE FDD (B1/3/5/7/8/20) / GPRS / EGPRS (GSM 900MHz/ GSM-DCS 1800 MHz)
Ethernet	10/100 Mbit/s, RJ45 connector, LSA terminals
Digital Input	2 x non-isolated inputs, which can be connected to various equipment such as a ripple control receiver
Digital Output	1x fully isolated switching contact to support fault isolation or other regulatory requirements. 230 V AC / 30 V DC, 5 A
Power Line Communication	Physical layer in accordance with ISO15118-3
APIs	local & cloud HTTP API Modbus TCP MQTT
OCPP standard	OCPP 1.6j

Safety	CORE
RCD protection	The CORE has a built-in residual current protection module with residual current detection ($I_{\Delta n} = 20\text{mA AC}$ and 6 mA DC), a separate residual current circuit breaker must be connected upstream of the installation at least type A ($I_{\Delta n} = 20\text{mA AC}$). IEC 60364-7-722 or the corresponding national installation regulations may contain additional requirements for the installation.
Electric shock protection class	III
Pollution degree	2
Ingress protection	IP66
Impact resistance	IK08

5. Technical specification



kWh display

The kWh display is located inside the LED ring and alternately displays the following values:

Session kWh

Displays the charged energy of the current charging process.

Total kWh

Displays the total charged energy of all charging sessions.

6. Scope of delivery

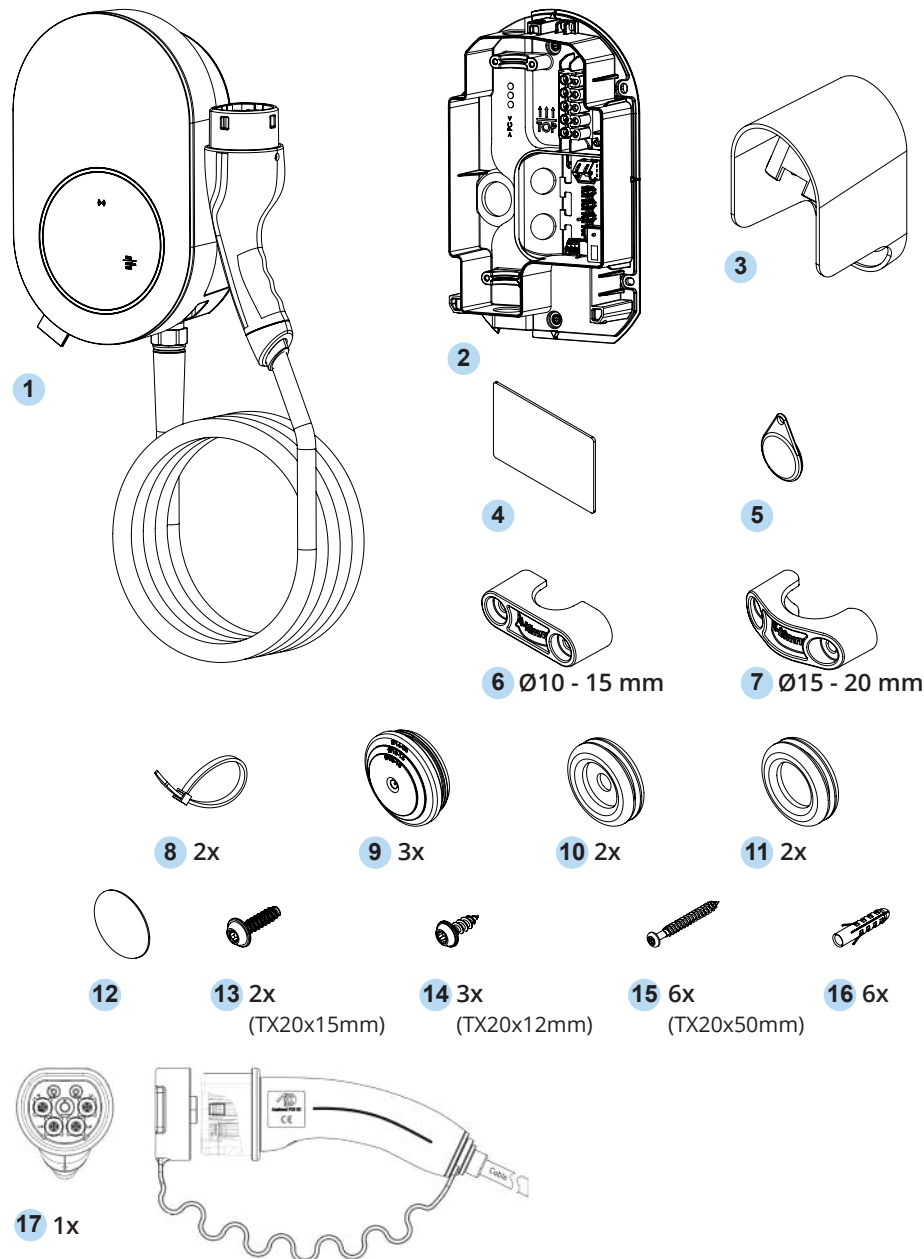

6. Scope of delivery

- 1 1x charging unit* with integrated typ 2 cable and type 2 plug
- 2 1x wall mount unit with grid connector & ethernet board
- 3 1x plug holder
- 4 1x reset card
- 5 1x RFID token
- 6 1x 10 mm - 15 mm cable clamp for electricity supply
- 7 1x 15 mm - 20 mm cable clamp for electricity supply
- 8 2x cable tie for ethernet/data cable strain relief
- 9 3x grommet (pre-installed) for electricity supply cable
- 10 2x grommet slotted, for ethernet/data cable routing
- 11 2x grommet (pre-installed) flat, for ethernet/data cable routing
- 12 1x sealing sticker for upper TX20x12mm screw
- 13 2x TX20x15mm screw for cable clamps fastening
- 14 3x TX20x12mm screw for charging unit to wall mount fastening
- 15 6x TX20x50mm screw for wall mount / plug holder to wall fastening
- 16 6x wall plug for wall mount / plug holder fastening screws
- 17 1x shutter cable
Used specifically for the go-e Charger CORE T2S to meet French installation standards and is only included in deliveries to France.

* The coloured silicone CORE tag is a design element only and does not affect functionality; damage to or loss of this tag is not covered under manufacturers guarantee.

7. Installation process



The installation must be carried out by a qualified electrician in accordance with your local installation codes and standards.



Risk of electrical shock: ensure the electricity supply is switched off at the main fuse board or other upstream circuit breaker.



The following screwdriver heads are needed for installation:



Step 1: Fix wall mount unit to wall

Parts:

1x wall mount unit,
4x TX20x50mm screws,
4x wall plugs

Equipment:

Pencil,
Electric drill & Ø8 mm drillbit,
Torx TX20 screwdriver

At the installation site, place the wall mount unit vertically on a flat, even section of the wall.



The PRO wall mount unit must be installed at a height between 0.5 m and 1.5 m above ground level, to ensure the charging plug is kept at a safe height. To ensure a Accessibility-compliant installation, a height between 0.85 m and 1.05 m above ground level is recommended. In France, Portugal, Denmark, Italy, Spain, Singapore and Sweden, a height of between 1.00 and 1.45 metres must be observed.



The mounting surface must cover the entire back surface of the charger.

7. Installation process



For rear cable routing it is recommended to fit the supply cable through the rear Wall Mount hole **before** alignment and marking the screw holes.



Use the built in spirit level and center markings for alignment.

Mark the 4 screw holes with a pencil, then set the Wall Mount aside.

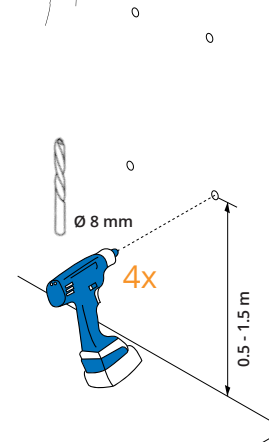

Drill 4x Ø8 mm holes to minimum depth of 50 mm at the 4 pencil marks.

7. Installation process

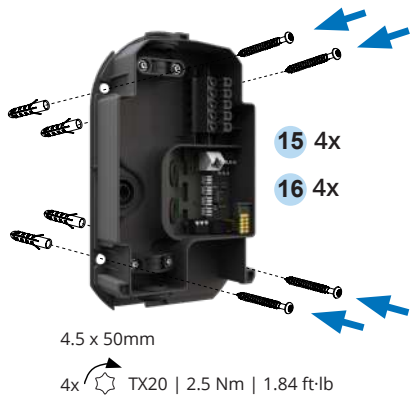

Insert the 4 wall plugs so that they sit flush with the wall.

Set the Wall Mount back against the newly inserted wall plugs.

Fasten the Wall Mount against the wall using the 4 TX20 screws, length 50 mm and Torx screwdriver. **Do not exceed 2.5Nm torque.**

Step 2: Connect to the AC supply

Parts:

Electricity supply cable clamp,
3x supply cable
Grommet (pre-fitted),
2x TX20x15 mm screws

Equipment:

AC supply cable,
Torx screwdriver,
Flat/Phillips screwdriver,
Box cutter



The CORE wall mount allows the AC supply cable to be routed from the top, rear and bottom to flexibly accommodate the infrastructure at the installation site.



The CORE supports either 1- or 3-phase electricity supply.

Ensure that the appropriate supply cable is selected for your needs. Solid conductor wire as mandated by installation standards should be used to ensure a robust electrical connection.

AC supply cable diameters between 10 mm and 20 mm are supported.



If not already done, ensure the electricity supply is switched off at the main fuse board or other upstream circuit breaker.

Measure the AC supply cable diameter and select the appropriate cable clamp (supported cable diameters are indicated on the clamp).

7. Installation process



Pop out the pre-fitted rubber grommet at the selected AC supply cable entry point: top, rear **or** bottom. **Recommended entry options are shown later.**

Recommended grommet cutting options:



Cut (with box cutter) or punch (e.g. with a pen) the grommet at the indicated position to create a hole at the required cable diameter. **Recommended cutting options are shown on the left.**



Carefully cut the grommet to ensure a clean, secure fit between grommet and cable.



The grommet is made from an elastic material: It is recommended to cut the smallest possible hole for your cable to ensure the tightest fit.

Thread the AC supply cable through the grommet.

Thread the AC supply cable through the selected entry point. **Recommended wire lengths within the Wall Mount for routing to the terminal block, for the various cable entry points are shown later.**

Secure the rubber grommet back in place.

Route the cable to the supply terminal block. **Recommended routing options are shown later.**

7. Installation process



3-phase

5x PZ1 | 1.5 Nm | 1.1 ft-lb

Depending on your electricity supply type (1- or 3-phase) thread in the individual wires (L1, L2, L3, PE, N) following the labels shown on the terminal block. **Wiring terminations for 1- and 3-phase supplies are shown later.**



Screw down with a flat / phillips screwdriver the termination block screws to clamp the wires in place. **Torque to 1.5Nm.**

13 2x

6



Ø10-15 mm

7



Ø15-20 mm

Screw the cable clamps into place using 2x TX20, length 15 mm screws and a Torx screwdriver for cable strain relief. **Torque to 2.7Nm (±0,1Nm).**



Only the top and bottom entry points require the cable clamps to be used.

The rear entry hole is suitable for cables entering directly out of a wall or pole.

2,0 x 15mm 2x TX20 | 2,7 Nm | 1.99 ft-lb

Recommended AC supply cable entry options

Routing	Min Cable Diameter	Max Cable Diameter	Recommended Use Case
Top	10 mm (3 x 2.5 mm ²)	15 mm (5 x 6 mm ²)	Electrical supply from above: Underground or shaded car-parks - e.g. apartment underground parking lots or home carports
Rear	10 mm (3 x 2.5 mm ²)	20 mm (5 x 10 mm ²)	Electrical supply from behind: Charger mounted on building or pedestal with electrical supply breaking out at desired installation height
Bottom	10 mm (3 x 2.5 mm ²)	20 mm (5 x 10 mm ²)	Electrical supply from below: Home carport, pedestal or open-air car park

7. Installation process

Recommended wire lengths

Recommended wire lengths for each cable entry point are shown below. These ensure enough length to correctly route the AC supply cable wires within the Wall Mount to the terminal block.



It is recommended to strip the insulation to expose 10 mm of copper to ensure a proper electrical connection.

Note! The given dimensions are minimum lengths. If the cables are cut shorter, they will no longer be suitable for the recommended routing.

3-phase



From TOP

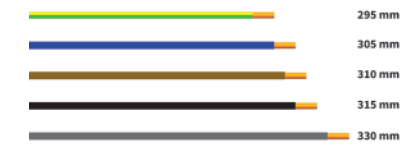

3-phase



From REAR

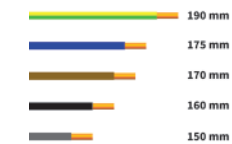

3-phase

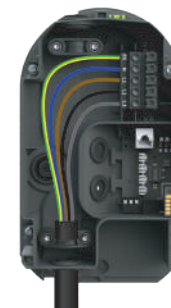

From BOTTOM

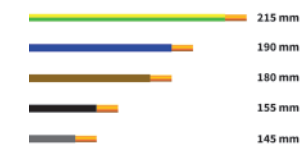

7. Installation process

Recommended wire routing for AC supply cable for top, rear and bottom entry:

 For the Top routing option, a U-bend of the wires is required to ensure that in the event of unexpected rain ingress, droplets are led away from the electronics and towards the drainage holes.

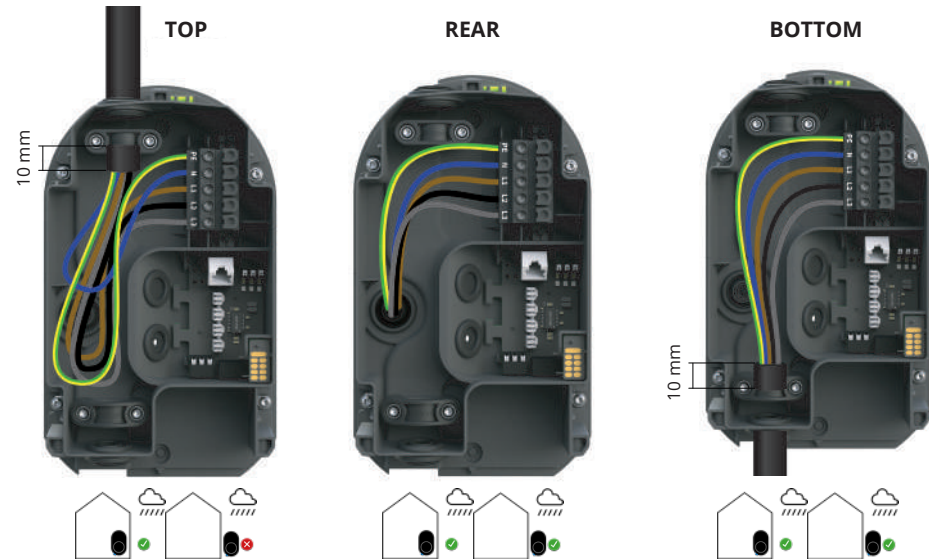

Wire Termination for 1- and 3-phase supplies:

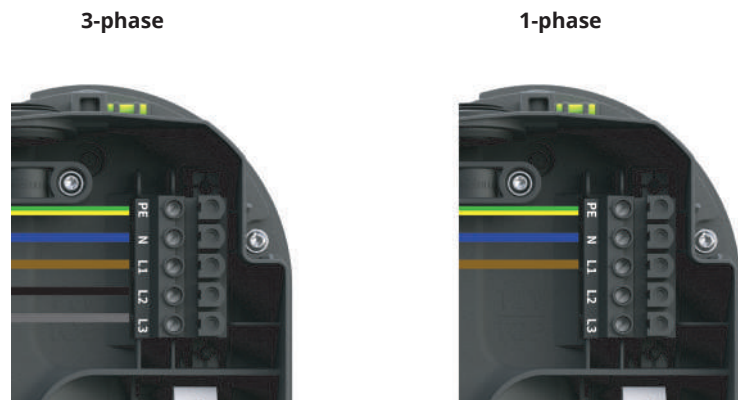



7. Installation process

Optional cable connections for data communication

Parts:
Cable ties,
Flat grommet (pre-fitted),
Slotted grommet

Equipment:
Ethernet/data cables as
required

 The CORE Wall Mount allows ethernet or other input and output control and data cables to be routed from the top, rear and bottom, using a dedicated cable channel behind the Wall Mount. Up to two cables can be installed at once.

 The cables emerge into the middle of the wall mount where they are terminated at a dedicated board.



Pop out the small rubber grommet at the selected cable entry point: top or bottom.

Thread the cable through the upper or lower cable channel and through the wall mount entry hole.

10 Punch a hole or use the spare slotted grommet provided with the packaging.

Thread the cable through the grommet and secure the grommet back in place.

Terminate the cable at the correct port. **Port functions and recommended terminations are shown below.**

Fasten the cable to the data termination board using the provided cable ties (see later).

7. Installation process

Data cable functions and ports:

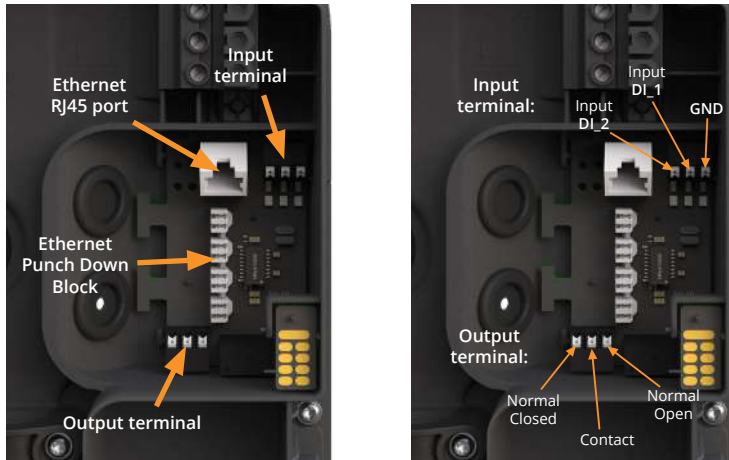

Port / Terminal	Data Cable Type	Use case
RJ45	Cat. 5 and above	Establish ethernet connection with internet router. Ideal for patch cables with pre-fitted connector
Punch Down Block (LSA)	Cat. 5 and above	Establish ethernet connection with internet router. Ideal for cables without pre-fitted connectors.
Input terminal	wire cross section: 0.2 - 1.5 mm ²	Receives input signals from external devices or circuits. E.g.: ripple control receiver from grid operator. Only permanently installed switchgears that meet at least the insulation requirement OVC 3, 230 V may be used. This must be checked by a qualified electrician before installation. Two input terminals available.
Output terminal	wire cross section: 0.2 - 1.5 mm ²	Sends signals to external devices or circuits. E.g.: to trip an external circuit breaker in the event of a fault in the charger

7. Installation process

- ! To establish an ethernet connection, either the RJ45 port **or** the LSA terminal can be used.
- ! go-e recommends using an ethernet cable without pre-fitted connectors, terminated at the LSA port. Used together with the flat grommet, this achieves the best sealing against rain. Ethernet field connectors must not be used. They are too large for the available space and will risk damaging the charger during installation.
- ! In case of a faulty LSA connection, a second ethernet cable can be connected to the RJ45 port and your Network Tester to test the connectivity of each wire.

Terminals & Strain relief:

Ethernet RJ45 terminal

- ✓ RJ45
- 8 0-2x 10 0-2x

- ! The strain relief should be used to secure the ethernet cable to protect against it accidentally being pulled/forced out.

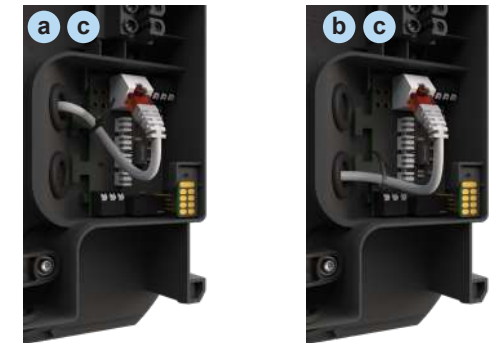

Ethernet punch down block termination

- ✗ RJ45



7. Installation process

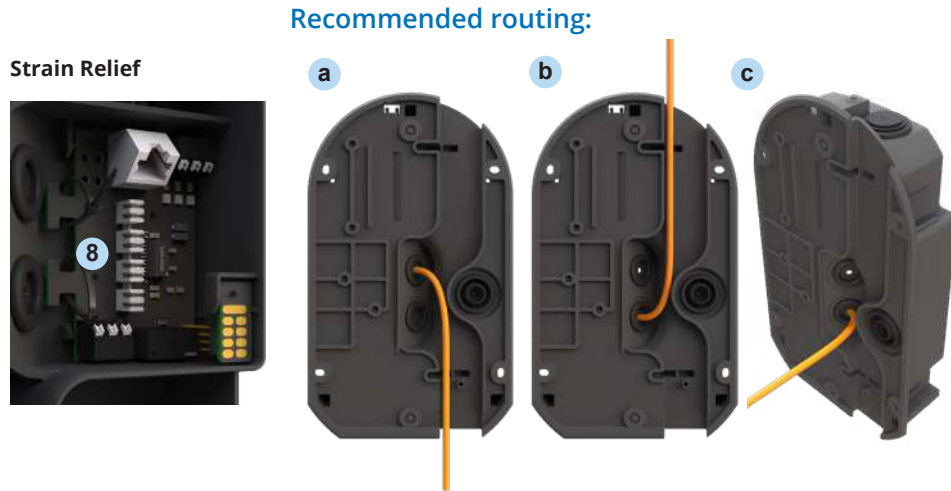

When using the upper routing channel, the data cable is required to be first led around the pin as illustrated above, to ensure rain is kept away from the grommets and to minimise risk of ingress.

Step 3: Connection of the charging unit

Parts:
Charging unit,
3x TX20x12mm Screw,
Screw sticker

Equipment:
Torx screwdriver,
Side cutters



Press the charging unit into the wall mount unit to mate.

7. Installation process



Secure the Charger in place using 3x TX20, length 12 mm screws and a Torx screwdriver, **applying a torque of 1.4Nm ± 0.1Nm.**

Apply the screw sticker over the top screw hole for additional protection against the elements.

! After installation, the CORE is permanently connected to your AC supply network and shall not be removed during normal operation.

! In case the product must be removed, removal must be performed by a qualified electrician. Ensure the electricity supply is switched off at the main fuse board or other upstream circuit breaker beforehand.

Optional

! For the Top AC supply cable routing option and Upper data cable routing option: cut the plastic breakout in the housing using a pair of side cutters.

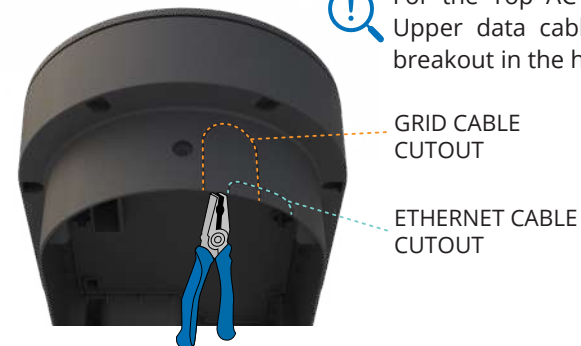

7. Installation process

Additional installation considerations

Installation of the plug holder

Parts:

1x plug holder,
2x TX20x50mm screws,
2x wall plugs

Equipment:

Pencil,
Electric drill & Ø8 mm drillbit,
Torx TX20 screwdriver



A charging plug holder is provided to keep the charging plug secure and dry when not in use:



- Stow the charging cable in the plug holder everytime after use to minimise risk of tripping.
- Do not pull on the charging cable beyond the full extension or when the cable is trapped on an obstacle or wound around the housing.

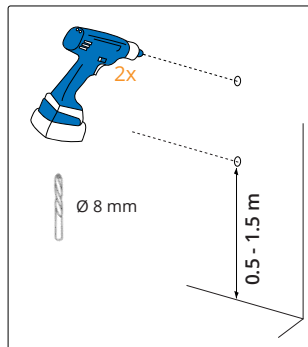

The plug holder must be installed at a height between 0.5 m and 1.5 m above ground level. To ensure a Accessibility-compliant installation, a height between 0.85 m and 1.05 m above ground level is recommended. In France, Portugal, Denmark, Italy, Spain, Singapore and Sweden, a height of between 1.00 and 1.45 metres must be observed.

Place the plug holder on a flat, even section of the wall. Mark the 2 screw holes with a pencil then set the cable holder aside.

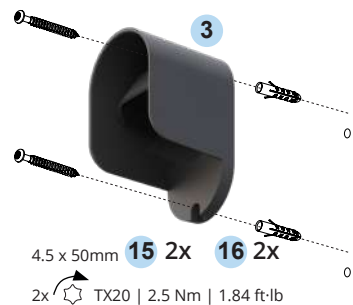

Drill 2x Ø8 mm holes to minimum depth of 50 mm at the 2 pencil marks.

Insert the 2 wall plugs so that they sit flush with the wall.

Set the plug holder back against the newly inserted wall plugs.

Fasten the plug holder against the wall using the 2x TX20, length 50mm screws and Torx screwdriver. **Do not exceed 2.5Nm torque.**

7. Installation process



Upstream protective devices

A miniature circuit breaker is not part of the CORE and must be connected upstream by a qualified electrician. The CORE has a built-in residual current protection module with residual current detection ($I_{\Delta n} = 20\text{mA AC}$ and 6 mA DC), a **separate residual current circuit breaker must be connected upstream of the installation** at least type A ($I_{\Delta n} = 20\text{mA AC}$). IEC 60364-7-722 or the corresponding national installation regulations may contain additional requirements for the installation.

Miniature circuit breakers with characteristic B or C for 16 or 32 amperes are permissible:

- 3- or 4- pole for three-phase connection
- 2-pole for single-phase connection

Ripple Control Receiver or Control Box of Grid Operator

In some territories the local grid operator requires to remotely control your charger during times of high electricity demand. The CORE is able to receive control signals from your grid operator by any of the 4 options below:



Germany for example mandates such an installation in accordance with §14a of the "Energie-wirtschaftsgesetz (EnWG)"

You can find more information (in German) via the QR code.

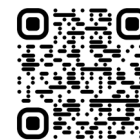

1. Connection to the potential-free output on the control box or ripple control receiver of the grid operator to the CORE digital input line.
2. Connection to a contactor circuit with connection to the grid operator's control box or ripple control receiver (only on/off) to the CORE digital input line.
3. Control via Modbus TCP using an external programmable logic controller (PLC)
4. OCPP interface of the grid operator

In option 1 & 2, the external control box or relay shall be wired into the wall mount - see instructions in the Optional Cable Connections above.

8. Commissioning



After the CORE charger is properly connected to the grid and powered on, it conducts a self-test upon initial startup or after a restart. During this self-test, the LEDs display rainbow colors to indicate that the system is checking its functionality. **Afterwards the go-e Charger is ready to charge!**

The basic functionality of the go-e Charger can be used without app or backend. To explore further grid and network configuration options, to change basic settings, use comfort functions, or control the charger remotely, you need to set it up. You can commission your go-e Charger using either the go-e app or the go-e Portal, depending on your needs:

- **go-e App:** Ideal for configuring a single device locally. The app can connect directly to the charger's hotspot, making it possible to complete basic commissioning even without an internet connection.
- **go-e Portal:** Best suited for remote and large-scale setup. It allows you to configure multiple chargers at once and apply shared settings across devices, making it ideal for fleet or commercial installations. **The commissioning process can be carried out via the go-e Portal without a direct connection to the hotspot of the charger by using cellular connection (LTE) or Ethernet.** In this case, you only need to enter the serial number and the default password of the reset card and can then also connect to WiFi.



portal.go-e.com

The go-e Portal can be accessed via the browser and also offers all the functions of the go-e app. A go-e Charger can be added to both the app and the Portal.

The Portal also offers special functions for company fleets to charge EVs at the company site and for charging company cars at home, for multi-family homes and destinations such as hotels.

8. Commissioning (via go-e app)

Set up connection via hotspot

The **go-e app is available for download** on the platforms listed below, depending on the operating system of the mobile device.



Open the app and select **"Set up device"** to start the commissioning process.



1. **Connect to the Charger:**
Option A: Scan the QR code on the reset card (you may need a QR code app).
Option B: Manually connect in your phone's WiFi settings to the network named go-e-xxxxxx. Enter the password labeled "Hotspot key" on the reset card. Then return to the go-e app.



Tips: Some smartphones require deactivating mobile data and terminating active WiFi connections. | If the go-e Charger hotspot is not displayed, go to the settings of your smartphone and allow the go-e app to connect to a local hotspot (often required for iOS).

2. **Set Grid Settings:**
After connecting, select your country to apply default grid settings.



To achieve a charging power of up to 22 kW, set the maximum charging current to 32 A. You'll also need to set a **technician password** to protect these settings. Once finished, you can continue with the next step.



Note: By default, the charger is limited to 11 kW (16 A on a 3-phase connection). A 22 kW setup requires a 3-phase electrical installation capable of delivering 32 A per phase.

8. Commissioning (via go-e app)

Set up connection via WiFi (optional)

For remote control of the Charger and for some comfort functions, an Internet connection of the Charger is essential.

3. Connect the Charger to WiFi:

Choose your WiFi network from the list and enter your password. If your WiFi doesn't appear, tap Add Network and enter your WiFi name (SSID) and password.

If you don't want to connect to WiFi now, skip this step. You can do it later through the settings of the go-e app.

4. Change the Charger Password (optional)

For improved security, you can now change the default charger password (shown on the reset card). Enter your new password.

If you prefer to keep the current password, skip this step.

5. Disconnect from hotspot

Finally, disconnect the hotspot connection with the Charger and switch your smartphone to an internet connection via mobile data or WiFi to remotely control the Charger. If the Charger is also connected via Ethernet, you do not need to do anything. The connection is prioritised.

8. Commissioning - app overview

The „Charger“ screen of the app shows you the status of your Charger. Here you can monitor and control the charging process of your vehicle.

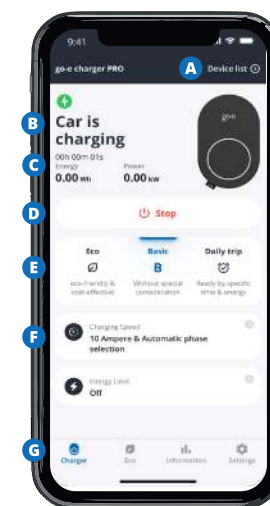

- A** If you own more than one go-e product, you can add, display and manage new devices in this list.
- B** In the charging status area, you can see the current charge status of your Charger, e.g. whether your car is currently being charged or whether it is waiting for PV surplus.
- C** Here you can see the total energy supplied during the current charging process (in kWh) and the current power output (in kW).
- D** The charging process usually starts immediately after connecting the vehicle, unless you changed settings in the app for PV surplus charging, for example, or activated access protection (authentication). In this case, you can start or cancel the charging process immediately using the start/stop button.
- E** You can choose your desired charging mode that suits your preference or schedule. ‚Eco‘ is for environmentally friendly and cost-effective charging, ‚Basic‘ is for regular charging without special settings, and ‚Daily Trip‘ is for setting a specific time and energy amount for your daily needs.
- F** Here you can see the charging speed in amperes and the number of phases used. You can change the charging speed by tapping this button.
- G** The tabs in the bottom navigation bar provide detailed information about the charging process and additional settings for a wide range of use cases.

8. Commissioning - load balancing

! Load balancing

If you use multiple go-e Chargers on the same power connection, enable the „Load balancing“ feature in the 'Settings' tab to avoid overloading your building's power supply.

! Static load balancing

Static load balancing sets a safe limit for a group of chargers to distribute load by priority among the chargers. This required a cloud connection (Internet).

! Dynamic load balancing

Dynamic load balancing optimizes charging speed while preventing overloads. It automatically adjusts each charger's power based on your building's real-time energy consumption and grid limit. This requires a go-e Controller connected to the device.



! Additional benefit with go-e Controller

The go-e Controller also enables charging with surplus solar energy and lets you monitor your energy flows in real time.

! Load balancing in fallback mode

If the network connection is temporarily interrupted, the go-e Charger can continue charging up to the charging current limit you set for fallback mode, wvided a charging current value bigger than 0 A has been entered for this purpose.

8. Commissioning - activating protocols

A OCPP - Open Charge Point Protocol

In this menu item you can find a slider to activate OCPP.

The address of the OCPP server needs to be entered in the OCPP server section.

Further OCPP settings can be made here, such as the phase assignment, which is necessary for proper load balancing, and the status of the connection can also be monitored.

B API (Cloud / local) and Modbus TCP

Here you can find several sliders for activating and configuring the go-e APIs. These include the local and cloud API as well as Modbus TCP. The links to the APIs publicly documented on GitHub are also provided.

C MQTT

MQTT can be activated and configured here. You will also find the link to the MQTT API documentation.

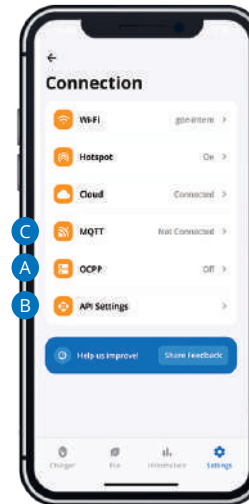

9. Charging process

Ready to charge - set charging current

The go-e Charger is ready for operation. The number of blue LEDs corresponds to the set charging current.

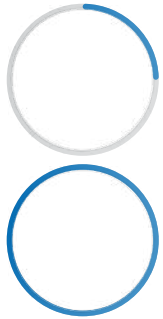

- Only a few blue LEDs light up = low charging current
- Many or all blue LEDs light up = high charging current



Start charging

To charge, simply plug the type 2 charging plug of the CORE into the charging port of your electric vehicle.



The go-e Charger CORE is equipped with a type 2 charging plug and is to be used with vehicles with a type 2 charging port.

Waiting for vehicle

The Charger is ready for charging and is waiting for the car to release it. The LEDs light up yellow in the number of the preset charging current.

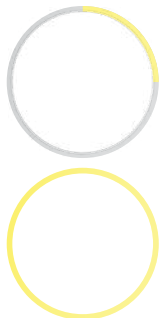

- Only a few yellow LEDs light up = low charging current
- Many or all yellow LEDs light up = high charging current

9. Charging process

Charging in progress

Once the vehicle confirms its readiness, charging begins. The CORE light ring will rotate clockwise.

The number of „tails“ corresponds to the number of connected phases or the number of phases set in the app:

- 1 rotating tail = 1-phase charging (230 V)
- 3 rotating tails = 3-phase charging (400 V)

The speed of rotation and length of the tails indicate the amount of charging current.



Charging completed / Stop charging

The charging process is completed when the LEDs light up green.

If you want to stop charging prematurely, use the „cable release“ function of your vehicle or stop charging via go-e app or go-e Portal.

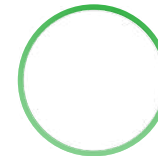

Waiting / Charging paused

The LEDs flash blue in the number of preset charging power.

The go-e Charger waits to charge based on a preset scheduler or to obtain cheap electricity when charging with a flexible electricity tariff.

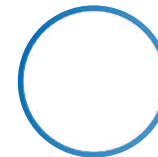

Activation required / Authentication

The LEDs light up blue and two white LEDs move from the top and bottom to the centre.

The „Access control“/„Charging mode“ is not set to „Open“. Use a learned RFID chip or the app to activate the charging process.

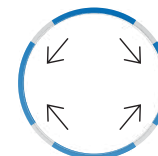

9. Charging process

How is authentication carried out?

If the CORE is installed in a public environment, you can protect the device from unauthorized use by requesting user authentication.

In the settings of the go-e Charger app, select 'Authentication is required' to enable charging via the RFID tags stored locally in the app and thus on the Charger, or 'Cloud Authentication' to start with an RFID tag stored in the cloud via the go-e Portal. Once 'Authentication is required' is enabled, the RFID token provided with the charger is used to 'unlock' the charger. The token is ready-to-use out of the box.



To unlock the charger simply hold the token against the RFID symbol located in the CORE light ring.

Alternatively, authentication can also be carried out via the go-e app by tapping the start/stop button on the 'Charger' tab.

Multiple Users

If several users need access to the charger, multiple tokens can be linked to the charger.

In the settings of the go-e Charger app, select „ Access control „ / „RFID chips.“ Simply select one of the free slots and follow the instructions provided to link each new token. The tokens can be individually renamed within the app. Any RFID chip/card that transmits at a frequency of 13.56 MHz, including many credit cards, can also be linked and used.

Dedicated user accounts have other benefits including tracking electricity consumption by user.

Additional RFID tokens are available from the go-e web-shop, or go-e partners.



For professional applications, we recommend using the go-e Portal to assign RFID tags to several chargers simultaneously via the cloud and to track their energy consumption.

9. Charging process

go-e Charger reset card

A reset card is provided with the charger.

On the back of the reset card, you will find essential access data required for setting up the app control of the charger:

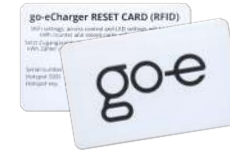

- **“Serial number“:** The serial number of the go-e Charger
- **“Hotspot SSID“:** The WiFi hotspot name of the charger
- **“Hotspot key“:** The WiFi hotspot password of the device
- **“QR-Code“:** Facilitates automatic connection to the hotspot.

Ideally, leave the reset card at a secure location where you can quickly access it in case you need it.

Reset to factory settings

The reset card can also be used to restore the go-e Charger to its factory settings:

- Position the reset card in front of the charger's RFID reader.
- All LEDs will light up red briefly to confirm the reset.

Please note that the stored RFID chips and recorded consumption data will not be deleted during this reset process.

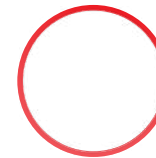

10. LED status display / Troubleshooting

The CORE indicates errors through specific colors codes on the LED ring, which are summarised below. You can also view the detailed error message within the ‚Status‘ section of the go-e app.

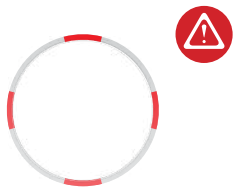

Ground check deactivated

4 LEDs light up red (3, 6, 9 and 12 o'clock).

The go-e Charger has the safety function „ground check“, which prevents the charging process in TT/TN power grids (common in most European countries) in case of insufficient grounding of the power connection. This function is enabled by default and can be disabled via the go-e Charger app.

However, the „Ground check“ should only be disabled if you are sure that the electricity grid has no grounding (IT grid, e.g. in many regions of Norway), so that charging can also be carried out here. If you are not sure, you must leave the setting in the app at „Enabled“!

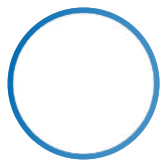

Waiting / Charging paused

The LEDs flash blue in the number of preset charging power.

The go-e Charger waits to charge based on a preset scheduler or to obtain cheap electricity when charging with a flexible electricity tariff.

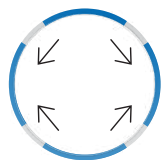

Activation required

The LEDs light up blue and two white LEDs move from the top and bottom to the centre.

The „Access control“/„Charging mode“ is not set to „Open“. Use a learned RFID chip or the app to activate the charging process.

10. LED status display / Troubleshooting

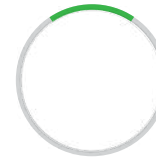

RFID chip detected

Upper LEDs light up green.

The go-e Charger has recognised an RFID chip authorised for charging and releases the charge.

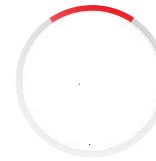

Unknown RFID chip

Upper LEDs light up red.

An unknown RFID chip was used. Use a learned RFID chip to activate charging.

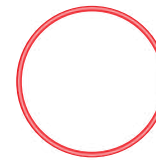

Internal error

The LEDs flash red.

The go-e Charger has detected a general communication error. Check the error code in the go-e Charger app.

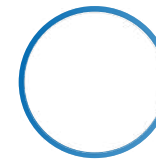

Vehicle is not recognised

The LEDs light up blue in the standby mode.

However, the charging process does not start. Check the charging cable and the tight fit of the plugs.

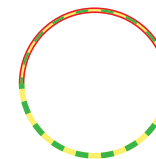

Grounding fault

The LEDs flash red at the top and glow green/yellow statically at the bottom.

Check whether the supply line to the go-e Charger is properly grounded.

10. LED status display / Troubleshooting

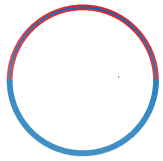

Phase error

The LEDs light up blue at the bottom and flash red at the top.

Check whether the phase/s of the go-e Charger are connected properly. It is possible that only 2 phases are connected. If no function occurs, contact the go-e Support.



Fault current detected

The LEDs flash red at the top and light up pink at the bottom.

The Charger has detected a DC fault current ≥ 6 mA or AC fault current ≥ 20 mA. To acknowledge the fault, press „Reboot“ in the app or disconnect the Charger from the power supply for a short time. If necessary, the charging current can be reduced, but also check the connection used. (The charging system in your vehicle may also be defective).

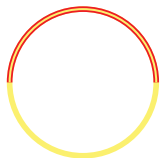

Increased temperature

The LEDs light up yellow at the bottom and flash red at the top.

The temperature in the go-e Charger is increased. Therefore, the charging current is automatically reduced.

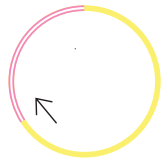

Firmware update

The LEDs flash pink and turn yellow with increasing progress of the update.

A firmware update was started via the go-e Charger app. This may take a few minutes. Do not disconnect the charger from the power supply during this time.

10. LED status display / Troubleshooting

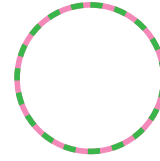

Firmware update successful

The LEDs light up alternately green and pink.

The firmware update has been successfully completed.

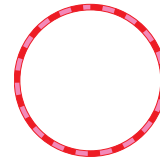

Firmware update failed

The LEDs light up alternately red and pink.

The firmware update could not be completed successfully. Please try again.

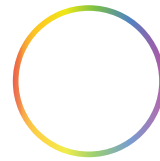

Start of the charger does not end

The LEDs light up permanently in rainbow colours.

If the charger does not leave this mode, the WiFi signal may be disturbed. Please remove possible sources of interference (e.g. devices with a WiFi mesh network).

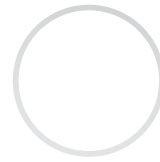

Connection cable/fuse

The LEDs do not light up despite a power connection.

Check the overload protection of the connection.

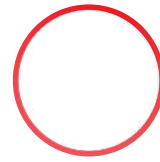

Reset card recognised

All LEDs light up red for 2 seconds.

The go-e Charger has recognised the reset card and is reset to factory settings.

11. Smart features

You can adjust the basic and comfort settings of the charger via the „Settings“ tab of the app. You will find help notes on the setting options in the app, which is why we provide here basic information on functionalities that have not already been mentioned in previous chapters.

Remote access (via WiFi, Ethernet and cellular connection)

The cellular connection is useful if you cannot connect the go-e Charger via WiFi or Ethernet but want to use all the smart features. Cellular connection is activated by default and can be deactivated in the app in the „Settings“ under „Connection“/“ Cellular“. If WiFi and cellular are activated at the same time, WiFi is favoured for data traffic. The combination is recommended as WiFi generally offers a higher speed when providing updates and enables more accurate technical support due to a higher number of data measurements. If an Ethernet connection exists, this is favoured over the other connection options.

Monitoring and configuration

Allows for the adjustment and monitoring of charging parameters, including voltage, current, power, and energy.

Electricity meter (total kWh and amount per RFID chip)

Tracks total energy consumption and monitors individual usage per RFID tag.

11. Smart features

Flexible energy tariffs - charge cheaper

If you have a contract with your electricity provider about a flexible electricity tariff with changing tariffs every hour or at certain times of a day, you can configure the Charger so that it charges your car at the cheapest hours. To do this, we have integrated flexible energy tariffs in the app to provide you with a sustainable and money-saving way of charging. The list of energy providers you can see in the go-e Charger app is constantly expanding, as dynamic electricity pricing is a relatively new concept. Check in the go-e app under „Eco“ whether your energy tariff is already integrated. Select the country you live in, your energy provider and the tariff you have signed up for with your energy provider. Then activate „ECO Mode“ or „Daily Trip Mode“ and set a price, time or kWh limit at which the go-e Charger should start or finish charging for the selected charging mode in the „Settings“ tab.

In „ECO mode“, you can set a price limit per kWh. As soon as the electricity price falls below the threshold you set, the wallbox charges your electric car.

In „Daily Trip Mode“, you can set a time and a kWh amount to charge your vehicle without a price limit. The go-e Charger automatically selects the cheapest hours for charging according to your electricity tariff until the specified kWh amount is reached within the set time limit. If you wish, you can continue charging in ECO mode by manually setting the charging price limit.

A cloud connection (Internet) is required for this functionality. The current prices are automatically transferred to the charger and displayed in the „Information“ tab.

11. Smart features

Photovoltaic surplus charging

Basically, the go-e Charger allows you to charge your car easily and automatically with surplus electricity from your photovoltaic system (PV). However, this requires an energy management system (EMS). The go-e Controller (separate product) is an example of such an EMS. The open interfaces of the go-e Charger also allow you to use other EMS. For these, however, you usually need to have programming knowledge or check in advance whether the EMS you want to use already has the go-e Charger integrated.

For charging with PV surplus power with go-e Charger and go-e Controller, customisations have to be made in the app under „Settings“ in „ECO Mode“ or „Daily Trip Mode“. There you will find a slider „Charge with PV surplus“, which you need to activate. You can then adjust the exact settings via the link „PV surplus“ below the slider. Here you can also opt for automatic phase switching in order to be able to charge even when the PV system's output is low. How charging works in conjunction with the go-e Controller is explained in detail in its instructions.

Combine cheap electricity tariffs and photovoltaic surplus charging

In combination with the Controller, you can even combine charging with PV surplus and favourable electricity tariffs in „Eco Mode“ and „Daily Trip Mode“. The Charger first tries to use as much solar power as possible and then continues charging with cheap electricity rates.

11. Smart features

Scheduler

The „Scheduler“ option allows you to postpone the charging process to a time when electricity is available in abundance (often at night). In this way, you act in a particularly sustainable way, as you do not increase the load peaks that are common at the end of the working day and take electricity that could otherwise not be used sensibly. In this way, you ensure grid stability. After activating the scheduler, you can define when the go-e Charger may charge or not charge. For weekdays, Saturday and Sunday, 2 time periods can be defined separately.

Save energy with kWh limit

The „kWh limit“ function is practical if you do not want to fully charge the battery because, for example, you live on a mountain and want to recuperate when driving downhill. Set in the „kWh limit“ menu how much energy should be charged until the next trip.

Push notifications

You can enable real-time push notifications to get push notifications about charging status, errors, and other updates.

Remote software updates

You can download software updates (firmware updates) to get new functionalities.

12. Guarantee, warranty and exclusions

1. go-e GmbH grants a guarantee for go-e Chargers of the CORE series against material and functional defects in accordance with the following conditions. The warranty period is 36 months (deviating from this in UK 60 months) from receipt of the goods after the first purchase of the product from go-e or a reseller. This warranty is in addition to the statutory warranty of 2 years (from receipt of the goods) and does not limit it.

2. The guarantee is only valid on presentation of proof of purchase stating the date of purchase.

3. In the event of a guarantee claim, the customer has to inform go-e GmbH immediately in text form to complain about the defect. In the event of a justified notice of defect, go-e is obliged to improve or replace the goods as soon as possible or to arrange this. In the (justified) case of the return of the defective product to go-e, go-e will bear the costs incurred. If, in the event of a guarantee claim, it becomes apparent that the device needs to be replaced, the customer waives ownership of the previous device from the date of return shipment and the new device simultaneously becomes the property of the buyer. This transfer of ownership also applies if, as a gesture of goodwill, a device is replaced outside the guarantee period at reduced conditions. If a defect that is justifiably notified within the guarantee period concerns a permanently installed charging station, go-e GmbH will send the customer a replacement box and will pay a total of up to 70 euros of the electrician's costs incurred in uninstalling the defective charging station and installing the replacement unit. In any case, evidence in the form of an invoice has to be provided. For safety reasons, the disassembly of an allegedly defective, permanently installed go-e product may only be carried out by a qualified electrician. Before dismantling the product, always contact go-e's technical customer support and wait for its decision on the further procedure for handling the service case. Repairs may only be carried out by the manufacturer go-e. For repairs not carried out by go-e, there shall be no claim to reimbursement of costs under the guarantee.

4. In the event of incorrect storage, use or installation/mounting by the buyer/installer and resulting damage to the product or other technical defects caused by the buyer/installer, the guarantee and statutory warranty shall expire. In this case the buyer bears the shipping costs. This applies especially if the product is not operated with a special original adapter manufactured by go-e GmbH or is used for other purposes than those specified by the manufacturer.

5. The guarantee and warranty also expires in the event of any modification or opening of a go-e product or if there is no proof of installation by a qualified professional. (e.g. commissioning certificate)

6. go-e GmbH shall make every reasonable effort to provide the operation of all free digital supplementary services in accordance with the representations in the operating instructions of the products, including but not limited to app and cloud functions. go-e does not, however, guarantee that these will always function error-free, fully available and without interruption. go-e GmbH does not provide any guarantee, warranty or assurance for these digital additional functions, but will endeavor to provide a workaround or update to rectify errors or eliminate faults free of charge within a reasonable period of time following an error/fault report by the customer. The customer's report can be made by telephone during go-e business hours, by e-mail to office@go-e.com or by using the contact form on the go-e web-site. go-e shall be entitled to apply restrictions for the elimination of errors/malfunctions and/or workarounds, as well as to postpone the elimination of errors/malfunctions until the release of an update. In order to fulfil this obligation, go-e GmbH is entitled to suspend the digital supplementary services due to planned or unplanned maintenance work, which is why go-e does not guarantee that the digital services will be available without restriction at any given time.

7. The coloured silicone CORE tag is a design element only and does not affect functionality; damage to or loss of this tag is not covered under manufacturers guarantee.

8. Claims arising from this guarantee shall be governed exclusively by Austrian law, excluding the conflict of laws provisions, in particular the UN Convention on Contracts for the International Sale of Goods.

13. go-e Charger CORE with Non-removable Battery (CR2477)

This chapter provides the technical justification for using a non-user-removable lithium button cell (CR2477) in the go-e Charger, in accordance with Regulation (EU) 2023/1542.

1. Battery Function and Data Integrity: The go-e Charger is equipped with a CR2477 lithium button cell which serves as a back-up power supply for the real-time clock, memory functions and tampering detection mechanisms. Continuous power supply supports the integrity of stored data (e.g., timestamps, configuration parameters and logs). Unintended removal by end users could cause data loss and malfunction of dependent functions. Therefore, the battery is designed as non-user-replaceable; removal and replacement can only be performed by qualified service personnel under controlled conditions.

2. Electrical Safety Considerations: The go-e Charger is an outdoor wallbox supplied from mains at hazardous voltage levels. Access to the CR2477 requires opening the enclosure, which may expose hazardous live parts. To avoid the risk of electric shock or unsafe interventions, opening the device and replacing the battery is restricted to qualified personnel only.

3. Regulatory Reference: Regulation (EU) 2023/1542, Article 11(3), provides a derogation from the end-user removability and replaceability requirements in Article 11(1) where continuity of power supply is necessary and a permanent connection between the product and the respective portable battery is required to ensure the safety of the user and the appliance, or for data integrity in products whose main function is to collect and supply data. Based on the safety considerations above, the go-e Charger justifies a non-user-removable design for the CR2477. The product is intended for outdoor use; however, the specific derogation in Article 11(2)(a) (washable/rinseable appliances regularly subject to water streams or immersion) is only of limited relevance here and is not relied upon as the primary justification.

4. Conclusion: Considering the electrical safety risks associated with accessing internal components and the need to maintain the integrity of stored data, the design decision to restrict access and replacement of the CR2477 battery to qualified personnel is consistent with Article 11(3) of Regulation (EU) 2023/1542.

14. CE Declaration of Conformity

Hereby go-e GmbH declares that the radio equipment type go-e Charger CORE and go-e Charger CORE T2S is in compliance with Directive 2014/53/EU. The full text of the EU Declaration of Conformity is available at the following internet address:

www.go-e.com



15. Contact and support

Do you still have questions about the go-e Charger?

You can find helpful answers concerning the most frequently asked questions, help for technical problems and troubleshooting on:
www.go-e.com

If you cannot find an answer to your question in this guide, on our website or in the app, please feel free to contact us:

Support

go-e GmbH

Satellitenstraße 1
9560 Feldkirchen
AUSTRIA

✉ support@go-e.com

☎ +43 4276 62400

www.go-e.com

