

EBMHS (standard & slim-line PSU)

Miniature HS PIR Presence Detector (luminaire fitting)

Overview



The EBMHS series of miniature PIR (passive infrared) presence detectors provide automatic control of lighting loads with optional manual control.

Three models are available: premium, direct dim, and analogue dim all of which will switch incandescent, fluorescent and compact fluorescent lighting. The direct dim variant controls DALI or DSI digital dimming ballasts whilst the analogue dim variant controls 1-10V dimming ballasts.

The unit detects movement using a PIR sensor and turns the load on. When an area is no longer occupied the load will switch off after an adjustable time out period.

A selection of fixing clips to allow the unit to be mounted in or to the side of a luminaire are available

All functionality is fully programmable using an IR handset.

Features

Sensor head

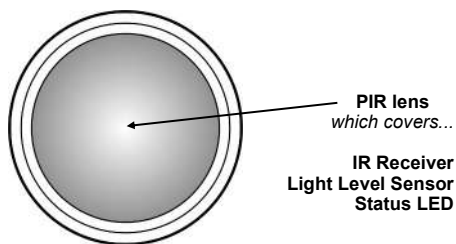

PIR Sensor

Detects movement within the unit's detection range, allowing load control in response to changes in occupancy.

IR Receiver

Receives control and programming commands from an IR (infrared) handset.

Light Level Sensor

Measures the overall light level in the detection area

Status LEDs

The LED flashes Red to indicate the following:

Walk Test LED active	when movement is detected
Valid setting received	

Standard power supply



Dimming version shown

Slim-line power supply

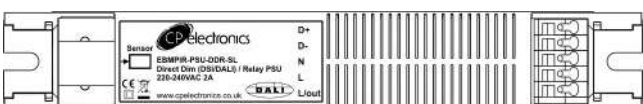

Dimming version shown

RJ11 connector

The sensor head has a flying lead with a RJ11 plug at the end plugs into the RJ11 socket on the power supply.

Standard power supply

This power supply has a 6A relay. It also has connections for an external switch that can be used to turn on the load when absence detection mode has been set or raised / lowered with dimming variants.

Slim-line power supply

Where space is at a premium the slim-line power supply is compact and suitable for luminaire mounting where a 2A relay is sufficient. This power supply does not have connections for external switches.

Detection diagram

Range

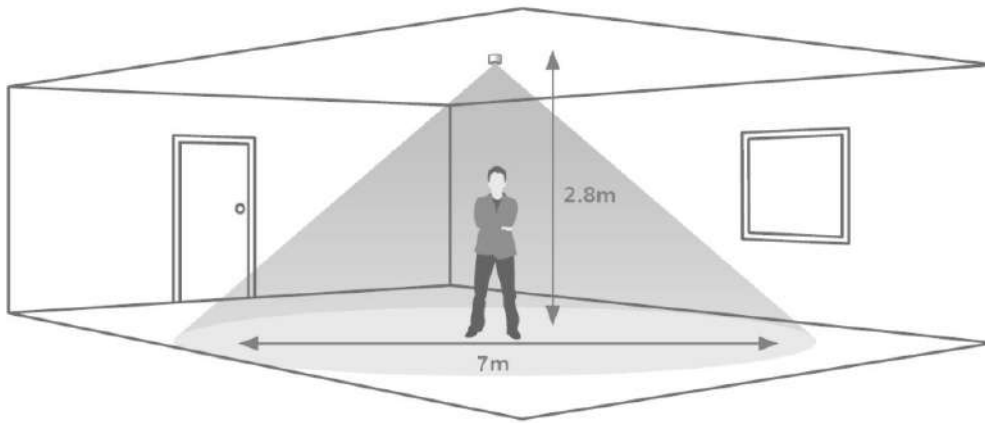

Area of high sensitivity  Area of lower sensitivity 

Note: illustration shows an average of the walk across and walk towards figures below.

Walk across

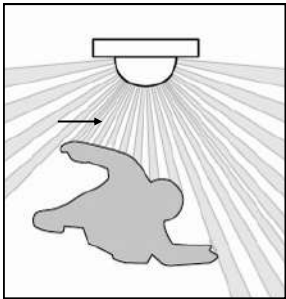

Height	Range Diameter
7m	16m
2.8m	9m

Walk towards

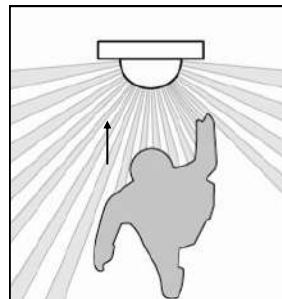

Height	Range Diameter
7m	10m
2.8m	5m

The product is designed to be mounted directly to a luminaire, either on the inside or outside. The detector should be sited so that the occupants of the room fall inside the detection pattern (shown opposite), at a recommended ceiling height of 2.8m. Note that the lower the sensor is installed the smaller the detection range will be, subject to the parameters shown on the detection diagram.

- The PIR lens must have a view outside the luminaire.
- For optimum operation of the lux sensor, the lens must be shielded as much as possible from the light source.
- If flush mounting in a panel >6mm thick, remove bottom of retention arms with side cutters.
- Avoid direct sunlight entering the sensor.
- Do not site within 1m of forced air heating or ventilation.
- Do not fix to a vibrating surface.

Sensor functionality

Detection mode

- **Presence** When movement is detected the load will automatically turn on. When the area is no longer occupied the load will automatically switch off after an adjustable time period.
- **Absence (standard power supply only)** The load is manually switched on. When the area is no longer occupied the load will automatically switch off after the adjustable time period has elapsed.
 - Switch operation:
 - PRM single switch: short press turn on, long press turn off.
 - EBMHS-DD & EBMHS-AD single switch: short press turn on, short press turn off, press and hold cycles dimming.
 - EBMHS-DD & EBMHS-AD two way switch: up button short press turns on, press and hold to dims up. Down button short press turns off, press and hold dims down.

In either case, sensitivity to movement of the PIR sensor can be adjusted using the Sensitivity parameter.

HINT: To assist in setting the Sensitivity, turn on the Walk Test LED which will flash red when movement is detected.

Switch Level On/Off

Occupancy detection can be made dependant on the ambient light level using the Lux On Level and Lux Off Level parameters.

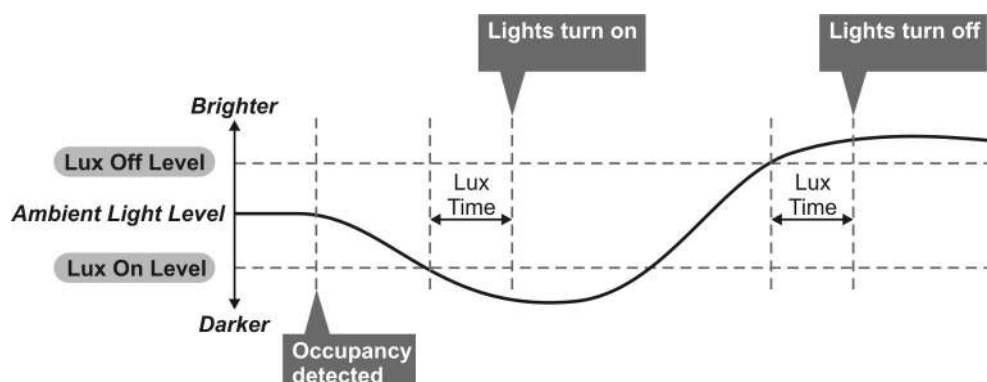

Maintained Illuminance (daylight harvesting) - DD and AD variants

only

The detector measures the overall light level in the detection area and calculates the correct output for the luminaires, to achieve a preset lux level (maintained illuminance or daylight harvesting).

Burn-in - DD and AD variants only

Burn-in - DD and AD variants only

• Overview

It is a requirement of many fluorescent lamp manufacturers to have the lamps on at maximum output for a period of time to guarantee lamp life (refer to the manufacturer's datasheet for details). As the EBMHS-DD & AD are able to dim the lamps using DALI/DSI or 1-10V, the products provide a facility to disable this for a given period of time.

• Operation

By setting the "Burn in" parameter, you can select a time during which the lamps are not allowed to deviate from maximum output. The unit counts the time, and even remembers how long has elapsed in the event of a power failure. To cancel the burn in function, simply select a time of 0. Note that when the lamps are changed, the burn in time should be set again.

Installation

Surface mounting

Use the lugs on rear of detector to secure into thin sheet metal (1mm max.).

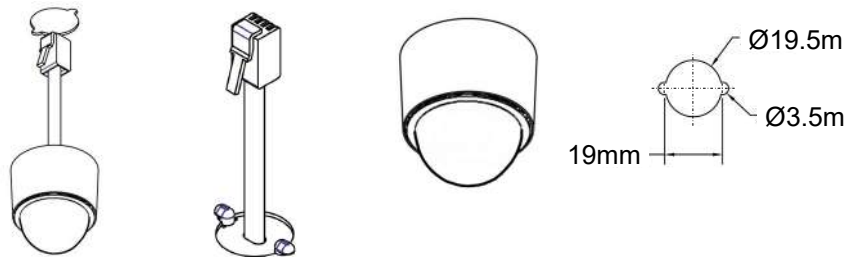

Side mounting

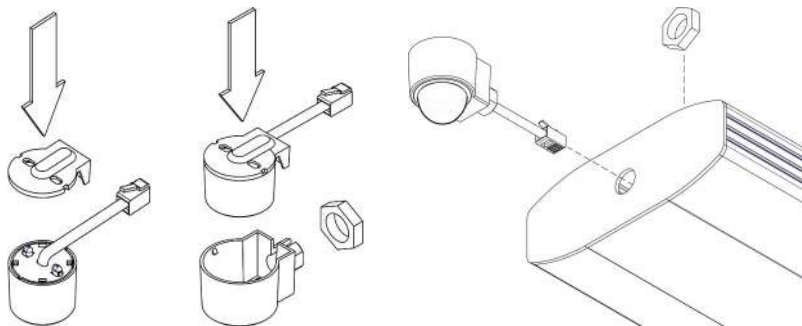

Flush mounting

The product can be mounted using the flush mount ring as shown. If flush mounting in a material that is greater than 6mm thick, remove bottom of retention arms with side cutters. A 32mm diameter hole will be required to mount the flush mount ring.

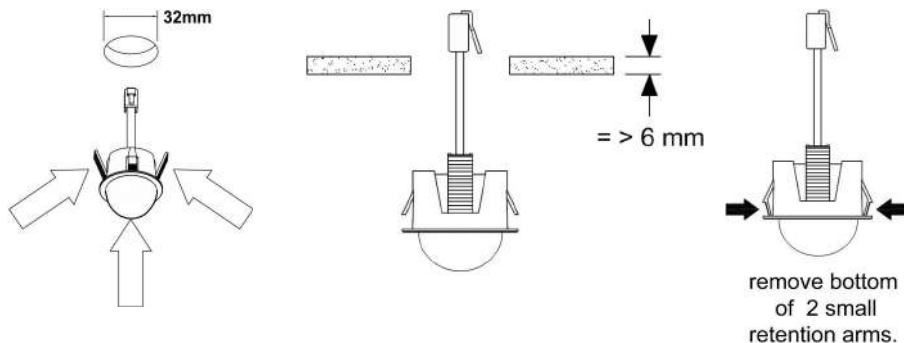

Readback function (only with UNLCDHS handset)

The UNLCDHS has the ability to read back the settings stored in a device.

To read back individual parameters

- Navigate to the parameter and press the 'R' (Read) button whilst pointing at the device. The handset will click when the parameter has been read back, the device will flash its LED, and the value will be shown against the parameter in the menu.

To read back all of the parameters in a menu

- Press and hold the 'R' (Read) button for more than 1 second.
- The handset will click every time a parameter is received
- The device will show multiple flashes of its LED
- All of the values will be shown against the parameters in the menu.
- The individual parameters may be edited and then saved as a 'Macro'.

Notes

- *If a parameter(s) has been missed because of a communication error, the missing value(s) is replaced by dashes.*
- *When reading back, the Channel 1 relay (where fitted) will temporarily be switched off, and will return to it's normal state 2 seconds after the read back has been completed.*

Fault finding

What if the load does not turn ON?

- Check that the live supply to the circuit is good.
- Check that the load is functioning by bypassing the sensor (e.g. link terminals **L** and **L/ Out**).
- If the detection range is smaller than expected, check the diagram on page 2. Rotating the sensor slightly may improve the detection range.

HINT: *The Walk Test LED function can be used to check that the unit is detecting movement in the required area.*

What if the load does not turn OFF?

- Ensure that the area is left unoccupied for longer than the Time Out Period.
- Ensure that the sensor is not adjacent to circulating air, heaters or lamps.
- If the unit "false triggers" reduce the sensitivity using the sensitivity settings

Power-up test procedure

When power is applied to the unit, the load will turn on immediately.

Set the timeout to 10 seconds, vacate the room or remain very still and wait for the load to switch off .

Check that the load switches on when movement is detected.

The unit is now ready for programming.

Wiring diagrams - standard power supply

Wire the products as shown in the diagrams. All switches are optional, however the dimming variants can have two switch configurations. If used with Option A, a single momentary switch can be used for absence detection and dimming up/down—set switch mode *1 position switch together* (see page 10). If used with Option B, a centre biased momentary switch gives the benefit of having separate switches to dim up and down—set switch mode *2 position switch together* in this case.

EBMPIR-PSU-PRMR - Non-dimming

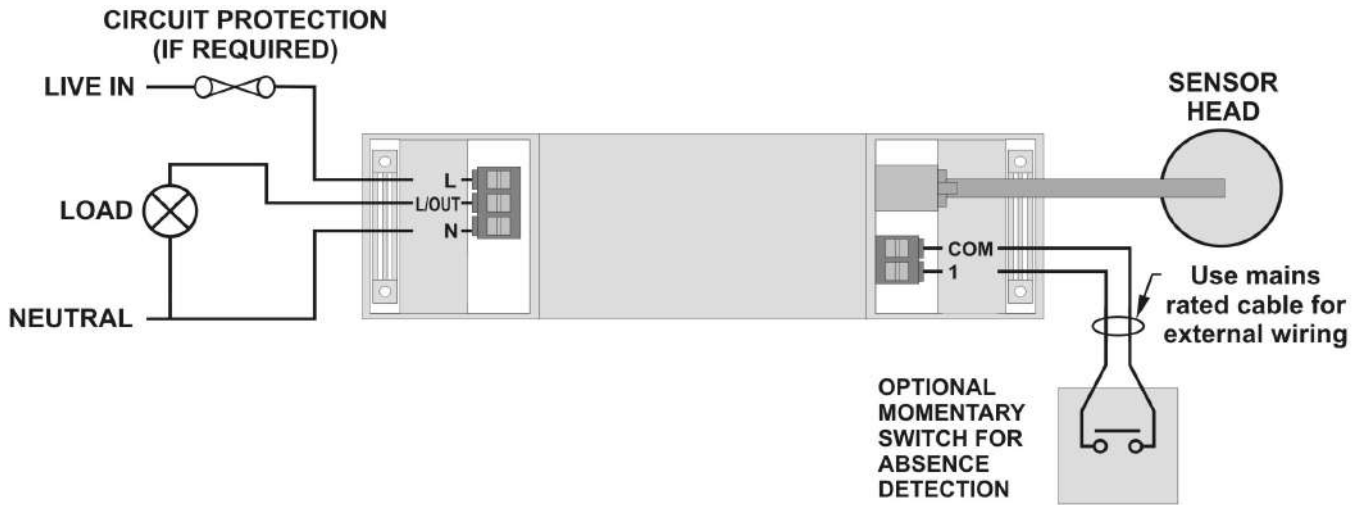

EBMPIR-PSU-DDR, EBMPIR-PSU-ADR — Dimming - Switch Option A

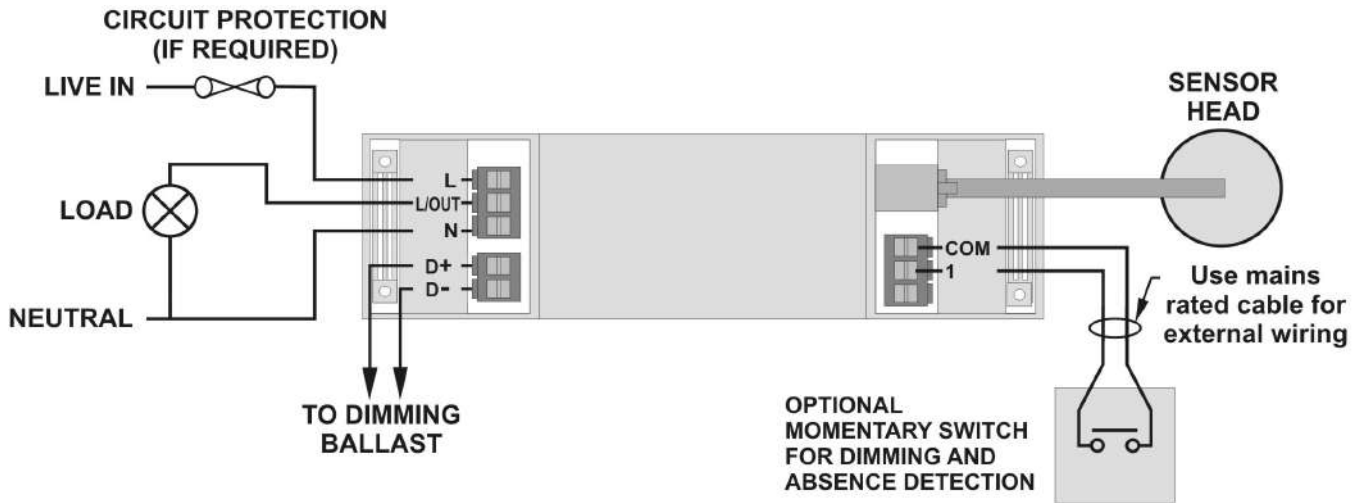

EBMPIR-PSU-DDR, EBMPIR-PSU-ADR — Dimming - Switch Option B

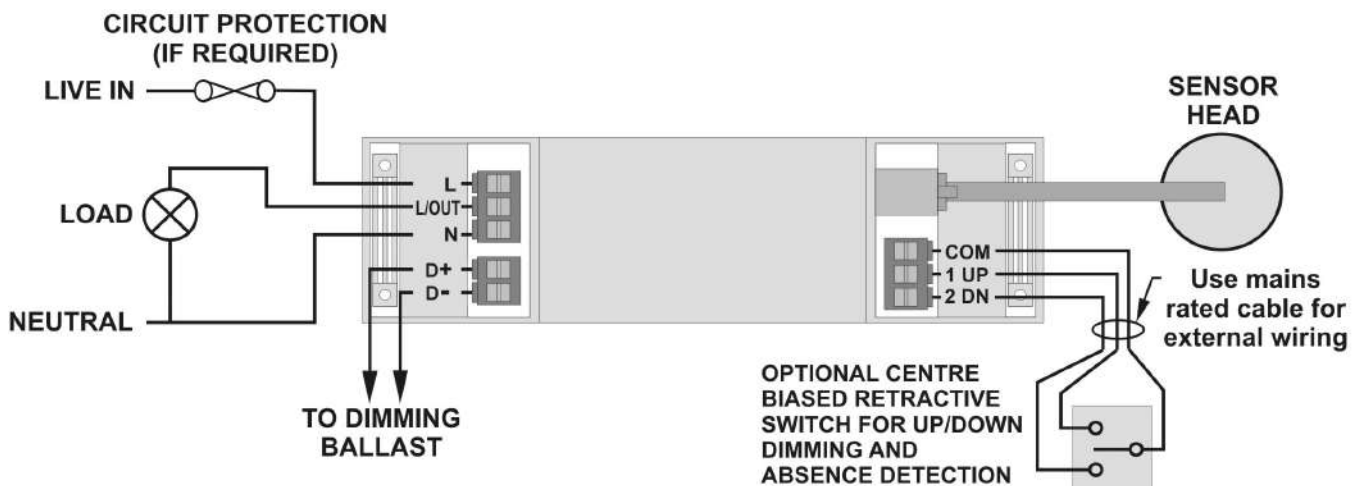

Wiring diagrams - slim-line power supply

Wire the products as shown in the diagrams. Four variants are available including a lower cost digital dimming version without relay.

Please note that there are no switch inputs with the slim-line power supplies.

EBMPIR-PSU-PRMR-SL

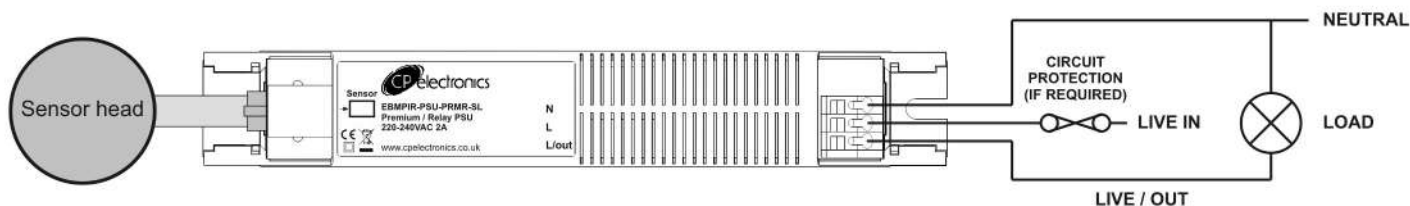

EBMPIR-PSU-DD-SL

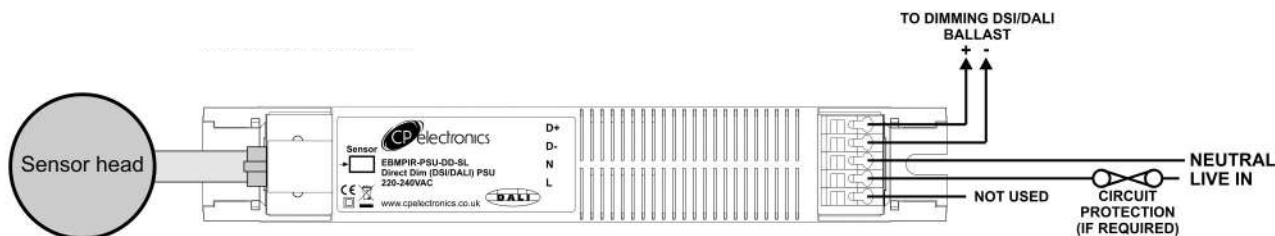

EBMPIR-PSU-DDR-SL

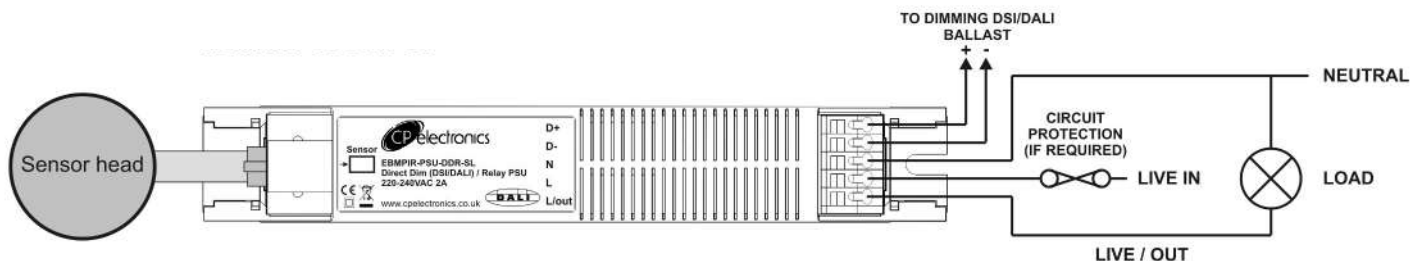

EBMPIR-PSU-ADR-SL

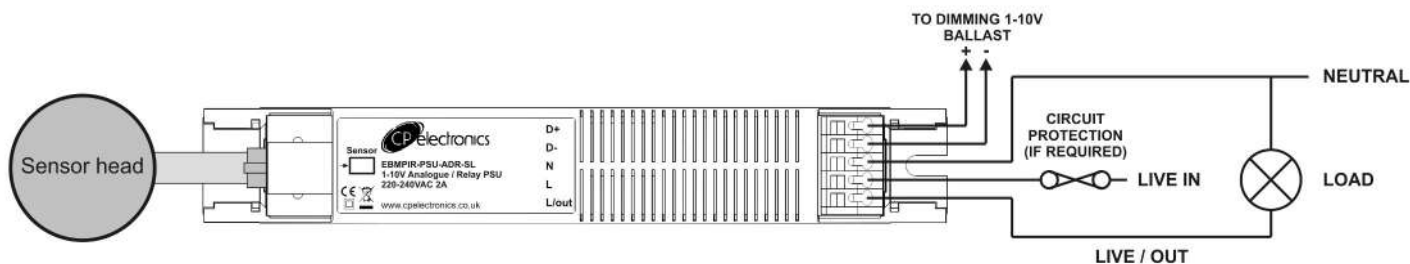

EBMPIR-PSU-PRMR-LV-SL-SA

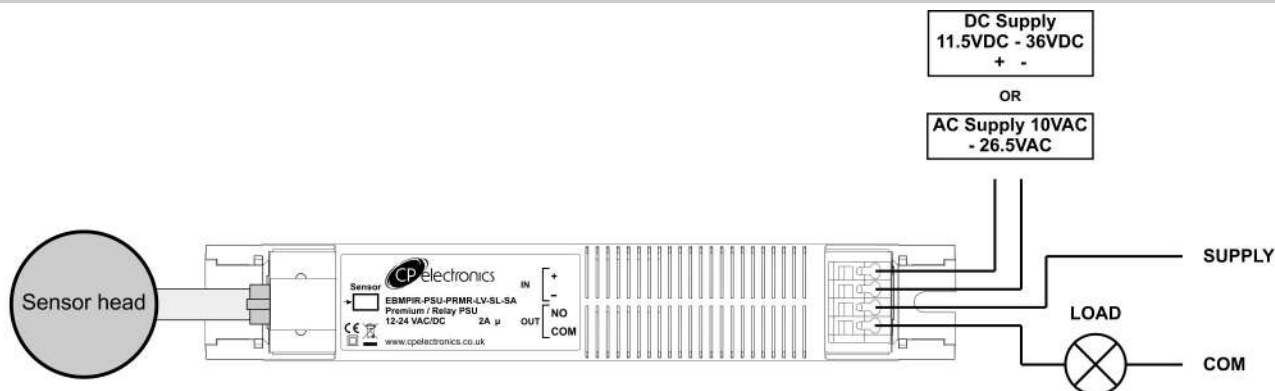

Note. Due to the proximity to other terminals, the low voltage supply (AC or DC) cannot be SELV if the output connections are mains (ie, non SELV).

Basic programming - PRM, DD and AD variants



The functionality of the EBMHS-PRM, DD & AD are controlled by a number of parameters which can be changed or programmed by any of the following devices:





















- **UHS5** Infrared Handset. See below for programmable functions.
- **UNLCDHS** Infrared Handset (with LCD). See user guide for full programming details.

For most basic programming operations the UHS5 handset can be used and the following procedures are based on using this device.

Point the handset at the Sensor and send the required programming commands to the unit as shown below.

Valid commands will be indicated by a red LED flash. See page 1 for details of other LED responses.

Note: other functions on the UHS5 which are not shown below are not applicable to this product.

Parameter Name	Default Value	Number of Shift key presses				UHS5 Handset Graphics	Description
		0  	1  	2  	3  		
Button Activation							
On / Raise		On	Raise				Turn lights on or to raise lights.
Off / Lower		Off	Lower				Turn lights off or to lower lights.
Walk test	Off	On	Off				When set to On this causes a red LED to flash on the sensor when it detects movement. Use this feature to check for adequate sensitivity levels.
Time Out (Time adjustment)	20 mins	1, 10 & 20 minutes	5, 15 & 30 minutes	10 seconds			Once the detector is turned on, this value sets how long the lights will stay on once movement has ceased.
Lux on level (Switch level on)	9	2, 5 & 7	4, 6 & 9				Lux level setting to prevent the luminaires being switched on if the ambient light level is sufficient (adjustable between 1 and 9). The luminaires will always be switched on at level 9.
Light Level (DD & AD only)	6 (600)			2 (200) 5 (500) 7 (700)	4 (400) 6 (600) 9 (999)		Sets a target light level to be maintained by the lighting system. 9 (999) = disabled.
Lux off level (Switch level off)	9	2, 5 & 7	4, 6 & 9				Lux level setting to switch the luminaires off during occupancy if the ambient light level goes above the setting (adjustable between 1 and 9). Level 9 will always keep the lights on. This setting can be used for "window row switching". <i>Note: the Lux Off Level value must always be greater than the Lux On Level value.</i>
Load Type (DD only)	DALI			2-DALI 7-DSI	2-DALI on		Sets the ballast control protocol to be used by the output channel.
Sensitivity	9	1, 5 & 9	3, 6 & 8				Sensitivity level for detecting movement. 1 = low sensitivity 9 = high sensitivity
Defaults				D			Returns the unit to the default settings.
Burn-in (DD & AD only)	0	0	50	100			Determines how long the output will be at 100% so that lamps 'burn-in'. The 'burn-in' time is not affected by power supply interruptions.
Presence / Absence	Presence	Presence	Absence				Presence mode allows the output to turn on when movement is detected and off when movement ceases. Absence mode allows the output to turn off when movement ceases, but must be manually turned on first.
Shift							Use this button to select the settings in red and blue signified by the 'Shift 1' and 'Shift 2' LEDs

Advanced programming

Parameter Name	Default Value	Range / Options	Description	UHS5	UNLCDHS
Detector Parameters					
Walk Test LED	Off	On or Off	When set to On this causes a red LED to flash on the sensor when it detects movement. Use this feature to check for adequate sensitivity levels.	✓	✓
Time Out (Time adjustment)	20 minutes	0-99 minutes	Once the detector is turned on, this value sets how long the lights will stay on once movement has ceased. Select 0 for 10 second delay – use for commissioning only.	✓	✓
Manual Time Out	10 minutes	0-99 minutes	When a manual operation occurs, either via the switch input or the infrared, it invokes the timeout period. Example 1: a detector in presence mode has a detector timeout of 15 minutes and a manual timeout of 3 minutes. When the user leaves the room they press the off button. The sensor will revert to automatic after 3 minutes, and then walking back in the room will turn the lights on. Example 2: using the settings above, the user turns the lights off (say for a presentation) but stays in the room. Every time a movement is detected, the manual timeout period is re-triggered, but when it doesn't pick up for the short timeout period, the sensor will timeout and revert to automatic. This means the lights may turn on inadvertently during the presentation, if the occupants are still for the manual timeout period, so adjust the timing carefully.	✗	✓
Sensitivity On	9	1 (min) to 9 (max)	Sensitivity level for detecting movement when the detector is already on. *UHS5 sets Sensitivity On and Off to the same value.	✓*	✓
Sensitivity Off	9	1 (min) to 9 (max)	Sensitivity level for detecting movement when the detector is off. *UHS5 sets Sensitivity On and Off to the same value.	✓*	✓
Lux time	0	0 (disabled) 1-99 minutes	If the detector measures the lux level and decides that the output needs switching on or off as a consequence, the lux time must elapse first. If at any time during the timed delay the lux change reverses then the process is cancelled. Lux Time enables absence detection to be implemented with a lux off level set. When the button is pressed, the lights will go on, regardless of ambient light level. However, if there is sufficient ambient light, they will turn off again after the Lux Time. <i>Note that whenever the an external switch is pressed, whether in absence or presence mode, if the lights were out because of the lux level, they will be immediately turned on again for at least the Lux Time.</i>	✗	✓
Power Up State	On	On or Off	Select No for a 30 second delay on start up. If Yes is selected, there will be no delay on start up and the detector will always power up detecting.	✗	✓
Disable Detector	N	Y or N	Disables detection, leaving the relay output permanently off with the dimming output operational. This mode is used when the unit is for maintained illuminance only.	✗	✓
On Delay	0 minutes	0-99 minutes	The On Delay to allows the first channel to switch on after the second channel. A typical application for this would be where a detector is controlling lighting and air conditioning in an area. When the occupant is detected, the lighting will be turned on immediately, whereas the air conditioning may be turned on after 15 minutes. If the area is vacated and the detector times out before the delay, then the air conditioning would never go on. The delay can be set only for channel 1 using the on delay parameter.	✗	✓
Inhibit	4 seconds	1 to 999 seconds	When the detector turns off, a delay is instigated to prevent retriggering. In certain circumstances this delay may not be enough. This parameter allows the delay to be changed.	✗	✓
Factory default	-	-	Restores factory default settings	✓	✓

Channel Modes					
Switch only	N/A	-			
Switch and dim together	Default	-	The detector will switch and dim the lighting together.	✗	✓
Switch and dim separate	N/A	-			

User Modes					
Raise (DD & AD only)	-	-	Increase light level. Reverts when occupancy cycle complete.	✓	✓
Lower (DD & AD only)	-	-	Decrease light level. Reverts when occupancy cycle complete.	✓	✓
Scene up	-	-	Steps up between 6 pre-defined scenes.	✗	✓
Scene down	-	-	Steps down between 6 pre-defined scenes.	✗	✓
Scene #	-	-	Select the individual scene, between 0 and 6. (1 = min. output; 2 = 10%; 3 = 25%; 4 = 50%; 5 = 75%; 6 = 100%)	✗	✓
Override On	-	-	If the lights are off, sending the IR command will turn them on immediately and revert to automatic operation using the manual timeout period.	✓	✓
Override Off	-	-	If the lights are on, sending the IR command will turn them off immediately. After the manual timeout period (described above), the sensor will revert to automatic.	✓	✓
Cancel	-	-	Cancels the on or off override, returning the detector to normal operation.	✗	✓

Advanced programming

Parameter Name	Default Value	Range / Options	Description	UHS5	UNLCDHS
Channel 1 –Switching Channel					
Detection Mode	Presence	Presence or Absence	Presence mode allows the output to turn on when movement is detected and off when movement ceases. Absence mode allows the output to turn off when movement ceases, but must be manually turned on first.	✓	✓
Lux on level (Switch level on)	9	1 to 9 For a higher resolution a scale of 101-199 is available	Sets a minimum light level below which the PIR sensor is enabled, allowing lights to be turned on by movement. <i>Note: the Lux Level Off value must always be greater than the Lux Level On value.</i>	✓	✓
Lux off level (Switch level off)	9	1 to 9 For a higher resolution a scale of 101-199 is available	Sets a maximum light level above which the PIR sensor is disabled, preventing lights from being turned on by movement.	✓	✓

Channel 2 -Dimming Channel (DD & AD only)					
Detection Mode	Presence	Presence or Absence	Presence mode allows the output to turn on when movement is detected and off when movement ceases. Absence mode allows the output to turn off when movement ceases, but must be manually turned on first.	✓	✓
Lux on level (Switch level on)	9	1 to 9 For a higher resolution a scale of 101-199 is available	Sets a minimum light level below which the PIR sensor is enabled, allowing lights to be turned on by movement. <i>Note: the Lux Level Off value must always be greater than the Lux Level On value.</i>	✓	✓
Lux off level (Switch level off)	9	1 to 9 For a higher resolution a scale of 101-199 is available	Sets a maximum light level above which the PIR sensor is disabled, preventing lights from being turned on by movement.	✓	✓
Light Level (maintained illuminance)	600	1 to 998 (999 disabled)	Sets a target light level to be maintained by the lighting system.	✓	✓
Load Type (DD only)	DALI	DSI DALI DALI On	Sets the ballast control protocol to DSI. Sets the ballast control protocol to DALI. DALI On provides a permanent voltage to DALI ballasts when DALI has not been implemented correctly in the ballast. Maximum number of ballasts is 4 unless the relay is disabled then it is 10.	✓ ✓ ✗	✓ ✓ ✓
Max Value	100%	0 to 100%	Maximum dimming output level.	✗	✓
Min Value	0%	0 to 100%	Minimum dimming output level.	✗	✓
Memorise	N	Yes or No	If this is set to Yes, the last manual lux level set will be memorised and used as the new switch on level.	✗	✓
On value	99	0 to 99	Dimming output level when switched on (0-99).	✗	✓
Off value	0	0 to 99	Dimming output level when switched off (0-99). If a non-zero off value is set, then the output will toggle between this value and completely off depending on the switch level on and off values. For example, if it is light outside, the fittings will be off if there is no occupancy. If it is dark outside, they will adopt the preset off value. This feature is only enabled if 'Min value' is set to 99.	✗	✓
Burn-in	0	0 (disabled) or 1 to 999 hours	Determines how long the output will be at 100% so that lamps 'burn-in'. The 'burn-in' time is not affected by power supply interruptions.	✓	✓
Fade value	10	0 to 99	After occupancy ceases, this dimming output level is loaded for the fade time (adjustable between 0 and 99).	✗	✓
Fade mins	0	0 to 99	This is the time period (adjustable between 0 and 99 minutes) that the luminaire will be held at the fade value before turning off. A value of 0 disables the fade function.	✗	✓
Speed On	40	Measured in 0.1 sec intervals.	Determines the dimming response speed after the setup time has finished.	✗	✓
Speed Set	5	Measured in 0.1 sec intervals.	Determines the dimming response speed during the set up time. Measured in 0.1 sec intervals. If set to 0 will disable dimming for "Set seconds" below, used if fittings are required to warm up before dimming.	✗	✓
Set Seconds	120	1 to 999 seconds	Determines how long the dimming response set-up period lasts on power-up or on setting change. This enables the desired lux level to be achieved rapidly when the lights come on, or during setup.	✗	✓

Switch Modes					
2 position switch together (DD & AD only)	Default	-	A single centre biased retractive switch will be used to control both channels together.	✗	✓
2 position switch separate	N/A	-			
1 position switch together (DD & AD only)	-	-	A single position retractive switch controls both channels together.	✗	✓
1 position switch separate	N/A	-			

Sensor head

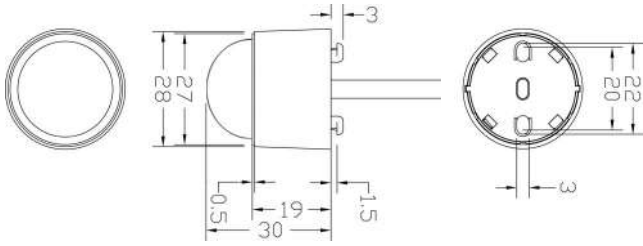

Power supplies

Standard

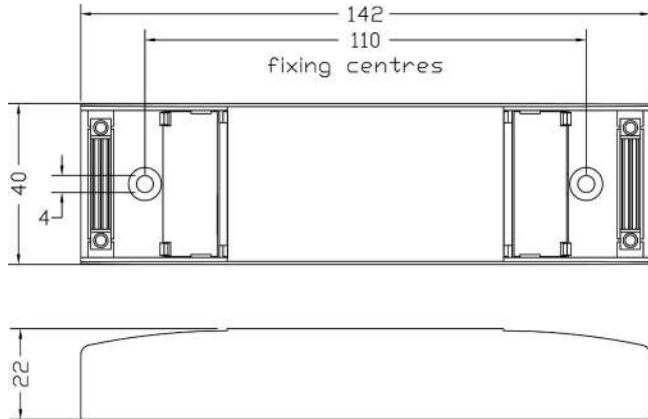

Slim-line

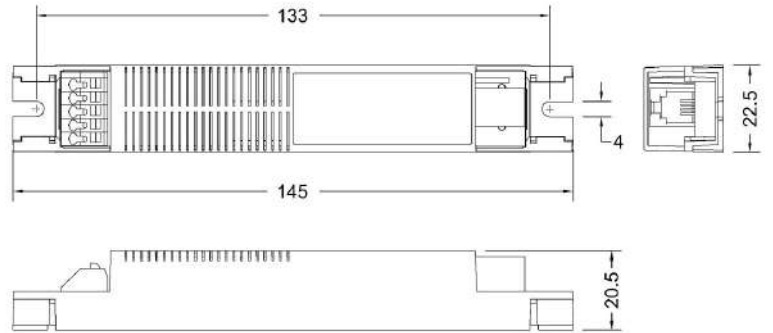

Brackets

Flush ring

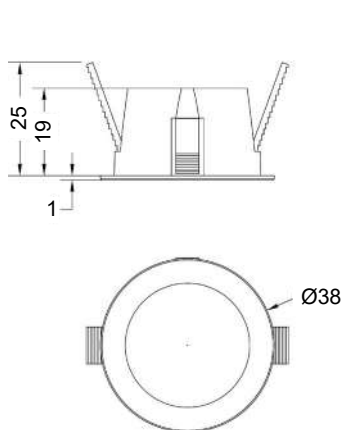

Head end cap

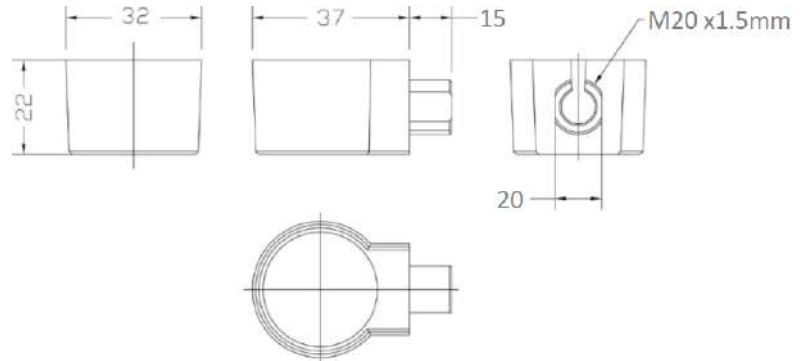

Technical data

Dimensions	See diagrams on page 11	Standard power supply	6A resistive and incandescent lighting 6A fluorescent lighting 3A compact fluorescent lighting 3A low energy lighting 3A low voltage lighting (switch primary of transformer) Fluorescent lighting (max 6 fittings recommended). For fluorescent lighting total power factor correction capacitance must not exceed 40µF 3 A fans and ventilation equipment Switch SON lighting loads via a contactor. Number of ballasts (DD & AD) Up to 10 dimming ballasts PRM On 816mW, Off 837mW DD On 923mW, Off 308mW AD On 1100mW, Off 522mW 1.0mm ²
Weight	Head: 0.02kg Standard PSU: 0.08kg Slim-line PSU: 0.05kg	Maximum Load	
Supply Voltage	All models - 230VAC +/- 10% <i>Except</i> EBMPIR-PSU-PRMR-LV-SL-SA 12-24VAC/DC EBMPSU-AD-SA-W 110-277VAC EBMPSU-DD-SA-W 110-277VAC		
Frequency	All models - 50Hz <i>Except</i> EBMPSU-AD-SA-W 50/60Hz EBMPSU-DD-SA-W 50/60Hz		
Dimming output	Basic insulation only. Although low voltage, this is not an SELV output and should be treated as if mains potential. Use mains rated wiring. -10°C to 50°C	Power consumption	
Temperature	5 to 95% non-condensing	Terminal Capacity	
Humidity	Sensor head, surface mount base plate, flush bracket - Flame retardant ABS	Slim-line power supply	2 Amps fluorescent and incandescent lighting. 2 Amps compact fluorescent lighting. 2 Amps low energy lighting. 2 Amps low voltage lighting (switch primary of transformer). Switch SON lighting loads via a contactor. Number of ballasts EBMHS-PSU-DD-SL - up to 10 dimming ballasts EBMHS-PSU-DDR-SL - up to 4 dimming ballasts. Refer to section on DALI ON for ballast quantities. EBMHS-PSU-ADR-SL - up to 4 dimming ballasts. PRM On 491mW, Off 253mW DD On 548mW, Off 245mW AD On 549mW, Off 276mW 0.75mm ²
Material	Standard power supply - PA (polyamide) Slim-line power supply - Flame retardant polycarbonate Type Class 2	Maximum Load	
IP rating	IP40		
Compliance	EMC-2014/30/EU LVD-2014/35/EU		
For further compliance information visit www.cpelectronics.co.uk/compliance			



Part numbers

	Part number	Description	
Detectors	EBMHS-AD-L03	AD (1-10V) mini prs/abs detector HS PIR head+300mm lead	
	EBMHS-AD-L1	AD (1-10V) mini prs/abs detector HS PIR head+1m lead	
	EBMHS-AD-SL-L03	AD (1-10V) SL mini pres detector HS PIR head+300mm lead	
	EBMHS-AD-SL-L1	AD (1-10V) SL mini pres detector HS PIR head+1m lead	
	EBMHS-DD-L03	DD (DALI/DSI) mini prs/abs detector HS PIR head+300mm lead	
	EBMHS-DD-L1	DD (DALI/DSI) mini prs/abs detector HS PIR head+1m lead	
	EBMHS-DD-SL-L03	DD (DALI/DSI) SL mini pres detector HS PIR head+300mm lead	
	EBMHS-DD-SL-L1	DD (DALI/DSI) SL mini pres detector HS PIR head+1m lead	
	EBMHS-PRM-L03	Premium mini prs/abs detector HS PIR head+300mm lead	
	EBMHS-PRM-L1	Premium mini prs/abs detector HS PIR head+1m lead	
	EBMHS-PRM-SL-L03	Premium SL mini pres detector HS PIR head+300mm lead	
	EBMHS-PRM-SL-L1	Premium SL mini pres detector HS PIR head+1m lead	
	Power supplies	EBMPIR-PSU-ADR	AD (1-10V) / Relay Mini PIR Standard Power Supply Unit
		EBMPSU-AD-SA-W	AD (1-10V) / Relay Mini PIR Standard Power Supply Unit standalone UL 110-277VAC
EBMPIR-PSU-ADR-SL		AD (1-10V) / Relay Mini PIR SL Power Supply Unit	
EBMPIR-PSU-DDR		DD (DALI/DSI) / Relay Mini PIR Standard Power Supply Unit	
EBMPSU-DD-SA-W		DD (DALI/DSI) / Relay Mini PIR Standard Power Supply Unit standalone UL 110-277VAC	
EBMPIR-PSU-DDR-SL		DD (DALI/DSI) / Relay Mini PIR SL Power Supply Unit	
EBMPIR-PSU-DD-SL		DD (DALI/DSI) Mini PIR SL Power Supply Unit	
EBMPIR-PSU-PRMR		Premium / Relay Mini PIR Standard Power Supply Unit	
EBMPIR-PSU-PRMR-SL		Premium / Relay Mini PIR SL Power Supply Unit	
EBMPIR-PSU-PRMR-LV-SL-SA		Premium / Relay Mini PIR low voltage SL Power Supply Unit	
Brackets	EBMPIR-ECW	Mini PIR head end cap - white	
	EBMPIR-FRW	Mini PIR head flush ring - white	
Accessories	UHS5	Programming IR handset	
	UNLCDHS	Universal LCD IR handset	

IMPORTANT NOTICE!

This device should be installed by a qualified electrician in accordance with the latest edition of the IEE Wiring Regulations and any applicable Building Regulations.

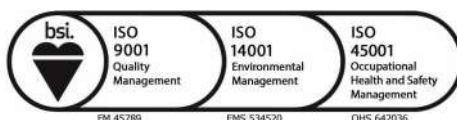

C.P. Electronics Ltd

Brent Crescent
London
NW10 7XR
United Kingdom
Tel: + 44 (0) 333 900 0671
Fax: + 44 (0) 333 900 0674
www.cpelectronics.co.uk
enquiry@cpelectronics.co.uk