



PRODUCT CATALOGUE

Shelly



ЕЛЕКТРОМАТЕРИАЛИТЕ...

sales@ldg-bg.com / <https://ldg-bg.com>

тел.: +359 2 862 8875 / GSM: +359 884 204 284

SMART AUTOMATION SYSTEMS

TABLE OF CONTENTS

INTRODUCTION	3
SHELLY CLOUD	4-5
SHELLY PLUS series	6-7
SHELLY PLUS 1	8-9
SHELLY PLUS 1PM	10-11
SHELLY PLUS 2PM	12-13
SHELLY PLUS i4	14-15
SHELLY 1	16-17
SHELLY 1PM	18-19
SHELLY 2.5	20-21
SHELLY DIMMER2	22-23
SHELLY RGBW2	24-25
SHELLY 1L	26-27
SHELLY EM	28-29
SHELLY 3EM	30-31
SHELLY UNI	32-33
SHELLY PLUG	34-35
SHELLY PLUG S	36-37
SHELLY BUTTON 1	38-39
SHELLY MOTION	40-41
SHELLY H&T	42-43
SHELLY TRV	44-45
SHELLY FLOOD	46-47
SHELLY DOOR/WINDOW 2	48-49
SHELLY GAS	50-51
SHELLY DUO	52-53
SHELLY DUO RGBW	54-55
SHELLY VINTAGE	56-57
SHELLY PRO series	58-59
SHELLY PRO 1	60-61
SHELLY PRO 1PM	62-63
SHELLY PRO 2	64-65
SHELLY PRO 2PM	66-67
SHELLY PRO 4PM	68-69
ACCESSORIES	70



MAKE YOUR HOME AND OFFICE SMART

Shelly is a line of home automation devices that allows customers to control their home directly through a mobile phone or with a preferred home assistant. Shelly's devices are retrofit, which makes them suitable for every electrical installation with no need of additional changes or improvements.

With Shelly you can:

- > Control the lights by adjusting brightness, colors, and set custom schedules.
- > Control the home appliances or office equipment from anywhere.
- > Save energy and money with precise power metering.
- > Set custom automation features.
- > Monitor temperature, humidity, and brightness.
- > Receive immediate notifications in case of any status changes.
- > Power consumption control

All Shelly devices are designed to offer maximum comfort of living, safety and easy installation.

Shelly - smart solutions for every home and office!



SHELLY APP



CONTROL YOUR HOME AND OFFICE WHEREVER YOU ARE! NO HUB REQUIRED!

All Shelly devices have:

- Embedded Web server
- Wi-Fi control and connectivity
- APIs for observation and control

YOUR SHELLY ACCOUNT

Shelly App user account is required to access, include, and control Shelly devices through the application. Once Shelly account is registered,

- Connect to existing W-Fi network or use Access Point mode locally to control Shelly devices
- Include, manage, and operate as many Shelly devices needed
- Configure devices and manage individual settings to every device individually
- Set custom scheduling for automatic actions by Shelly devices
- Create personalized rooms for more convenient control of the devices
- Define custom Groups to control multiple devices with one command in the app
- Build simple and complex scenes by combining Shelly devices to trigger certain actions in your home automation
- Monitor current and past electrical power consumption of the electrical circuit(s) and loads (for Shelly devices equipped with Power measuring capabilities)
- Build complex automation solutions for improved energy and operational efficiency
- Real time alerts and notifications based on your preference

FREE MOBILE APP



SHELLY CLOUD SERVICES

Shelly App offers possibility to control all Shelly devices remotely from any internet connection by using the Shelly Cloud Services – our own free cloud service with data storage.

HIGHLY COMPATIBLE!

Shelly devices are compatible with the most widely accepted both local and cloud based home automation platforms. Having a Shelly user account is necessary to include your Shelly devices to home automation platform.

All Shelly devices come with a REST API documentation, which is available at <http://shelly-api-docs.shelly.cloud/>

MQTT is supported by our firmware, which provides additional flexibility in the integration of Shelly to your home automation solution. And more integrations are added frequently.



amazon alexa



Google HOME



Yandex Alice



SmartThings



Home Assistant



Home Connect Plus



Homey



HomeSeer



iBroker
Automate your life

SYMCAN



HOOBS
HOME BRIDGE OUT OF THE BOX



nynea

NEXT GENERATION HOME AUTOMATION AND CONTROL

Shelly smart relays now come with perfected electrical appliances control through an extremely fast processor, quicker connectivity, improved integration, and enhanced safety! You can now add devices easily via Bluetooth connection, using Shelly Cloud App. Shelly Plus line supports TLS encryption and has an improved shell for standardized support for external sensor plugs.

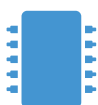

Extremely fast processor



Bluetooth connectivity



Improved integration



Enhanced safety



Scripting

IMPROVED AND COMPACT SHELL

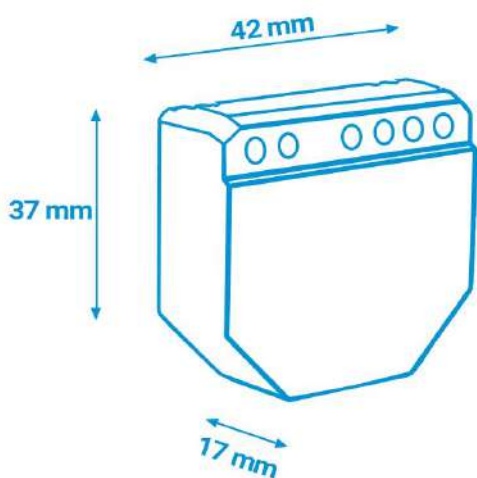

Shelly Plus line comes in a unified and improved form with small dimensions that allow easy fit behind any wall switch or wall socket, and are fully retrofit. Each Plus line device comes with a wiring diagram printed on its shell to ensure safe and easy installation.



HTTP/HTTPS webhooks

Get notifications or control another compatible equipment or 3rd party automation system.



Scripting for custom automation

Get enhanced functionalities and additional processes settings for a specific integration or function.



Weekly scheduling automation

Quickly set actions based on your daily or weekly schedule.



Smart actions for dynamic control

Set Shelly Plus devices to switch on/off the power, based on the Sunset/Sunrise hour and enjoy dynamic control.

Shelly PLUS

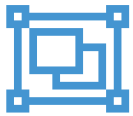

Improved API interface



Standardized RPC



Lower implementation cost

IMPROVED INTEGRATION

Shelly Plus line has an improved API interface and standardized RPC, allowing a broad range of cloud-connected and local integrations for a much lower cost for implementation. Scripting functionalities allow customization of home automation experience with a specific integration.

ENHANCED SAFETY & SECURITY

Shelly Plus line provides enhanced safety with additional temperature sensing software thresholds for control and prevention of failures. Devices' firmware now supports more encryption modes and secure storage.

An improve security is guaranteed by MQTT and WSS support, as well as custom certificates support for a broad range of use cases. Devices can be used with your one local or a centralized server, keeping them fully isolated from the public Internet.



Overtemperature protection



Failures prevention



MQTT and WSS support

SHELLY PLUS LINE



SHELLY PLUS 1



SHELLY PLUS 1PM



SHELLY PLUS 2PM



SHELLY PLUS i4

Shelly PLUS 1



LIGHTS THAT FOLLOW YOUR SCHEDULE

Automate your lights with Shelly Plus 1 and use Shelly App to set automated scenes based on hour or sunset/sunrise or based on the hour you come back from work.

GARAGE DOOR CONTROL

Easily automate your garage door and control it no matter where you are! Shelly Plus 1 has operational voltages of 12V DC and 24-48V DC.



IRRIGATION SYSTEM THAT FOLLOWS THE WEATHER

Use scripting functionalities and Shelly Plus 1 to automate your irrigation system. That way it will water your garden only when it is sunny, skipping the rainy days.



Wi-Fi operated

Connect Shelly Plus 1 to your Wi-Fi network. No HUB required.



Bluetooth

Add devices quickly and easily via Bluetooth connection, using Shelly Cloud App.



Dry contacts

Use a wide range of output voltage levels. Supports low voltages.



Extremely fast processor

For immediate command execution and notification.



Enhanced safety

Over-temperature protection for prevention of failures.



Enhanced security

MQTT and WSS support, TLS certificate support and management for a broad range of use cases.



Improved API interface

Broad range of cloud connections and local integrations.



No hub required

Control directly without a hub through your smartphone with Shelly Cloud App.



Highly compatible

Use with your preferred home automation platforms and voice assistants.

PERFECTED HOME AUTOMATION EXPERIENCE AND ENHANCED LIGHTING CONTROL!

Intended for mounting behind the wall switch console or power socket, **Shelly Plus 1** brings enhanced control and automatization of the lights, garage door, the irrigation system, bathroom fan, and pretty much every old electrical appliances. Thanks to its small dimensions, it can fit even in the tiniest spaces.

TECHNICAL SPECIFICATIONS

Power supply	<ul style="list-style-type: none"> • 110-240V, 50/60Hz AC • 24-48V DC • 12V DC
Max load per channel	16A
Complies with EU standards:	<ul style="list-style-type: none"> • RE Directive 2014/53/EU • LVD 2014/35/EU • EMC 2014/30/EU • RoHS2 2011/65/EU
Working temperature	-20°C ÷ 40°C
Radio signal power	1mW
Wireless/WiFi Protocol	802.11 b/g/n (2.4 GHz)
Frequency:	2412 - 2472 MHz
Operational range (depending on local construction)	<ul style="list-style-type: none"> • up to 50 m outdoors • up to 30 m indoors
Dimensions (HxWxL)	42x37x17 mm
Electrical consumption	< 1,2 W
Wire cross section range	0.5 ÷ 1.5 mm ²

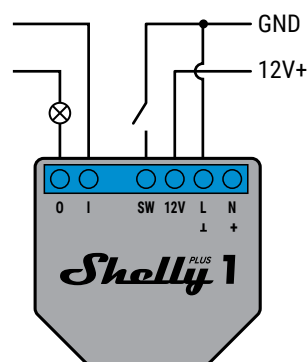
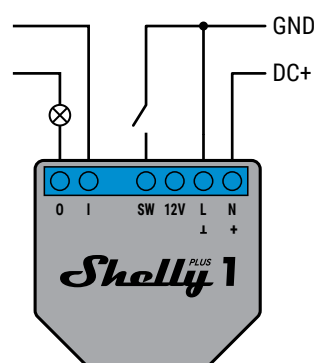
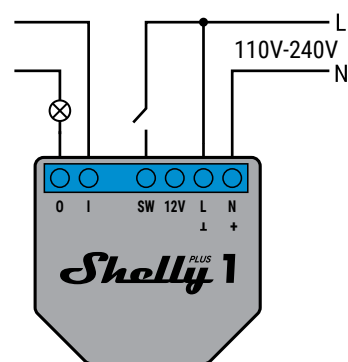

Legend

Terminals:

- N:** Neutral terminal
- L:** Live (110-240 V) terminal
- O:** Relay output terminal
- I:** Relay input terminal
- SW:** Switch terminal
- +**: DC positive terminal (24-48 V)
- ⊥:** DC ground terminal
- 12 V:** DC positive terminal (12 V stabilized)

Wires:

- N:** Neutral wire
- L:** Live (110-240V) wire
- GND:** DC ground wire
- DC+:** DC positive (24-48 V) wire
- 12V+:** DC positive (12 V) wire

Shelly ^{PLUS} 1PM



TRACK THE POWER CONSUMPTION

Shelly Plus 1PM has an integrated precise power meter that allow you to measure the power consumption and features free data storage for analysis.



HEATING CONTROL ON SCHEDULE

Set Shelly Plus 1PM to turn on the heating appliances in your house an hour before you come from work. Remotely monitor the power consumption of your heaters to make sure they're running and warming up.



APPLIANCES AUTOMATION

Get precise measurement of the power consumption of your home appliances and switch them on/off remotely, no matter where you are.



Power metering with data storage

Provides precise monitoring of the power consumption.



Wi-Fi operated

Connect Shelly Plus 1 PM to your Wi-Fi network.



Bluetooth

Add devices quickly and easily via Bluetooth connection, using Shelly Cloud App.



Extremely fast processor

For immediate command execution and notification



Enhanced safety

Over-temperature protection for prevention of failures.



Enhanced security

MQTT and WSS support, TLS certificate support and management for a broad range of use cases.



Improved API interface

Broad range of cloud connections and local integrations.



No hub required

Control directly without a hub through your smartphone with Shelly Cloud App



Highly compatible

Use with your preferred home automation platforms and voice assistants.

NEXT GENERATION APPLIANCES CONTROL WITH PRECISE POWER METERING

Small enough to fit behind any wall switch or wall socket, **Shelly Plus 1PM** is designed for retrofit applications and can be installed in less than 10 minutes. From automatization of the lights to electrical appliances control, Shelly Plus 1PM provides precise power metering and free cloud data storage.

TECHNICAL SPECIFICATIONS

Power supply	<ul style="list-style-type: none"> • 110-240V, 50/60Hz AC • 24-30V DC
Max load per channel	16A
Complies with EU standards:	<ul style="list-style-type: none"> • RE Directive 2014/53/EU • LVD 2014/35/EU • EMC 2014/30/EU • RoHS2 2011/65/EU
Working temperature	-20°C ÷ 40°C
Radio signal power	1mW
Wireless/WiFi Protocol	802.11 b/g/n (2.4 GHz)
Frequency:	2412 - 2472 MHz
Operational range (depending on local construction)	<ul style="list-style-type: none"> • up to 50 m outdoors • up to 30 m indoors
Dimensions (HxWxL)	42x37x17 mm
Electrical consumption	< 1.2 W
Wire cross section range	0.5 ÷ 1.5 mm ²

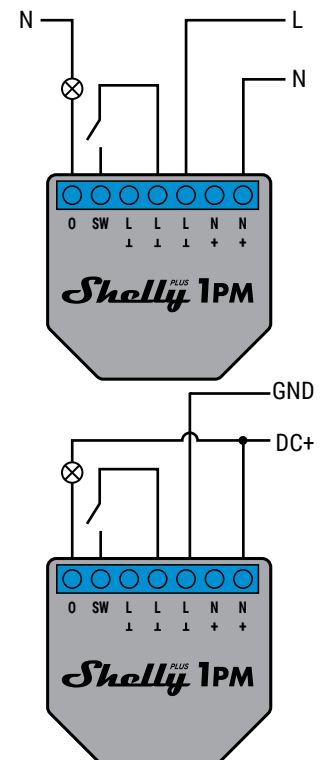

Legend

Terminals:

N: Neutral terminal

L: Live (110-240V) terminal

O: Output terminal

SW: Switch terminal

+: DC positive terminal

⊥: DC ground terminal

Wires:

N: Neutral wire

L: Live (110-240V) wire

GND: DC ground wire

DC+: DC positive (24-30 V) wire



Shelly PLUS 2PM



CURTAINS THAT FOLLOW YOUR SCHEDULE

Use the “Schedules” function to create the perfect morning/evening routines by setting Shelly Plus 2PM to open/close the curtains in your home at pre-set hours every day.

AWNING THAT FOLLOWS THE FORECAST

Set Shelly Plus 2PM to close your garden awning in case of a strong wind to prevent it from breaking.



CONTROL 2 LIGHTS WITH ONE DEVICE

Shelly Plus 2PM allows you to control and monitor two different circuits, measuring their consumption separately.

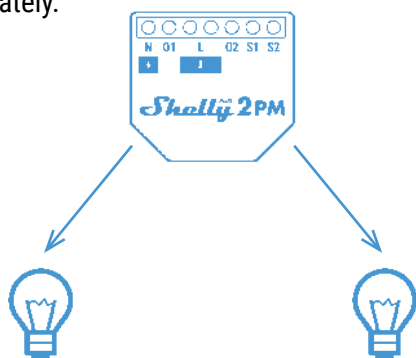

Wi-Fi operated

Connect Shelly Plus 2PM to your Wi-Fi network. No HUB required.



Bluetooth

Add devices quickly and easy via Bluetooth connection, using Shelly Cloud App.



Power metering with data storage

Provides precise monitoring of the power consumption.



Cover (roller) and position control

Control two-directional AC motors and set your desired position.



Wide range of voltage support

Can be powered by 110-240V AC & 24V DC, and supports up to 10A per channel and 16A total.



Extremely fast processor

For immediate command execution and notification.



Enhanced safety

Over-temperature protection for prevention of failures.



Enhanced security

MQTT and WSS support, TLS and custom certificates support for a broad range of use cases.



Improved API interface

Broad range of cloud connections and local integrations.



No hub required

Control directly and without a hub through your smartphone with Shelly Cloud App.



Highly compatible

Use with your preferred home automation platforms and voice assistants.

NEXT GENERATION 2-CHANNEL RELAY WITH COVER AND POSITION CONTROL

Shelly Plus 2PM allows automation of roller shutters, blinds, curtains, awnings, gates, and any bi-directional AC motors. Two integrated precise power meters allow you to measure the consumption for each channel separately. Shelly Plus 2PM has scripting functionalities for customized features and even more intuitive automation.

TECHNICAL SPECIFICATIONS

Power supply	<ul style="list-style-type: none"> • 110-240V, 50/60Hz • 24 V \pm10%,
Max load per channel	10A
Max. device load	16A
Complies with EU standards:	<ul style="list-style-type: none"> • RE Directive 2014/53/EU • LVD 2014/35/EU • EMC 2014/30/EU • RoHS2 2011/65/EU
Working temperature	-20°C \div 40°C
Radio signal power	1mW
Wireless/WiFi Protocol	802.11 b/g/n (2.4 GHz)
Frequency:	2412 - 2472 MHz
Operational range (depending on local construction)	<ul style="list-style-type: none"> • up to 50 m outdoors • up to 30 m indoors
Dimensions (HxWxL)	42x37x17 mm
Electrical consumption	< 1,4 W
Wire cross section range	0.5 \div 1.5 mm ²

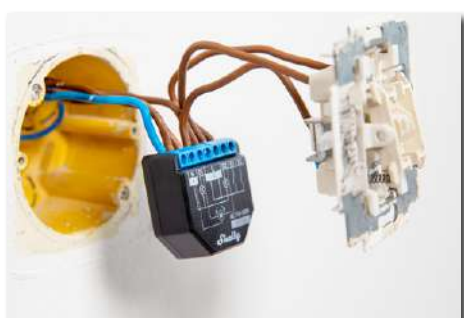

USE SHELLY PLUS 2PM TO AUTOMATE:

- ✓ Blinds
- ✓ Roller Shutters
- ✓ Curtains
- ✓ Awnings
- ✓ Garage Doors
- ✓ Lights

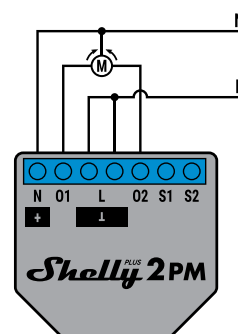
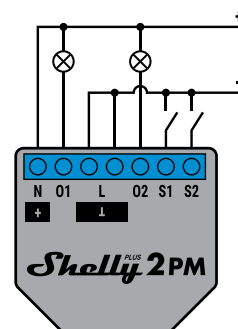
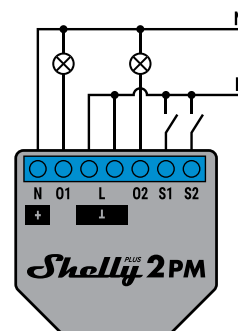

Legend

Device terminals:

- O1:** Load circuit 1 output terminal
- O2:** Load circuit 2 output terminal
- S1:** Switch (controlling O1) input terminal
- S2:** Switch (controlling O2) input terminal
- L:** Live (110-240 VAC) terminals
- N:** Neutral terminal
- +**: 24 VDC positive terminal
- :** 24 VDC negative terminal

Wires:

- N:** Neutral wire
- L:** Live (110-240 VAC) cable
- +**: 24 VDC positive wire
- :** 24 VDC negative wire

Shelly PLUS i4

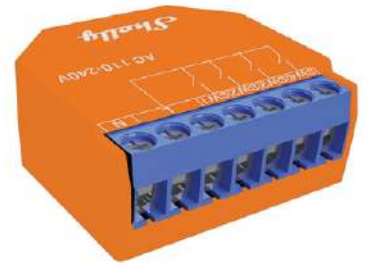

COMPLEX SCENE ACTIVATION

Manually activate or deactivate complex scenes. With Shelly Plus i4 you can run synchronized actions of several Shelly devices. You can install Shelly Plus i4 close to the front door of your home and turn off/on all the lights in your house with one push of the button, saving you time when you are in a hurry.



MANUAL CONTROL OF OTHER SHELLY DEVICES



Wi-Fi operated

Connect Shelly Plus i4 directly to your Wi-Fi network.



Bluetooth

Add devices quickly and easy via Bluetooth connection, using Shelly Cloud App



Wide range of voltage support

Shelly Plus i4 can be powered by 110-240 V AC



Multi-actions support

Up to 12 possible actions.



Extremely fast processor

For immediate command execution and notification



Enhanced security

MQTT and WSS support, TLS and custom certificates support for a broad range of use cases.



Improved API interface

Broad range of cloud connections and local integrations.



No hub required

Control directly and without a hub through your smartphone with Shelly Cloud App.



Highly compatible

Use with your preferred home automation platforms and voice assistants

SMART SCENES ACTIVATION WITH ENHANCED CONTROL

Shelly Plus i4 allows customers to manually activate or deactivate any created scene, run synchronized actions, or execute complex trigger scenarios. Shelly Plus i4 can control other connected Shelly relays, sensors, or HTTP and MQTT-controlled devices. Thanks to its small dimensions, it can fit behind every wall switch.

TECHNICAL SPECIFICATIONS

Power Supply	• 110-240V, 50/60Hz AC
Multi-click support	Up to 12 possible actions (3 per button)
Complies with EU standards	<ul style="list-style-type: none"> • RE Directive 2014/53/EU • LVD 2014/35/EU • EMC 2014/30/EU • RoHS2 2011/65/EU
Working temperature	-20°C ÷ 40°C
Radio signal power	1mW
Radio protocol	WiFi 802.11 b/g/n
Frequency:	2412 - 2472 MHz
Operational range (depending on local construction)	<ul style="list-style-type: none"> • up to 50 m outdoors • up to 30 m indoors
Dimensions	42x37x17 mm
Electrical consumption	< 1mW
Wire cross section range	0.5 ÷ 1.5 mm ²



Smart Bulbs control like never before

Whether you use Shelly Wi-Fi bulbs or different brands smart bulbs, Shelly Plus i4 is highly compatible and can control them all! Furthermore, you can use Shelly Plus i4 to set the light color you want or for dimming of your smart bulbs. All you have to do is add and configure one of our scripts or webhooks created specifically for Shelly Plus i4

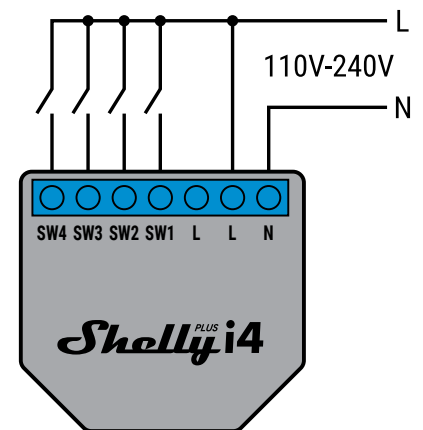

Legend

Terminals:

- N:** Neutral terminal
- L:** Live (110-240V) terminal
- SW1:** Switch terminal
- SW2:** Switch terminal
- SW3:** Switch terminal
- SW4:** Switch terminal

Wires:

- N:** Neutral wire
- L:** Live (110-240V) wire

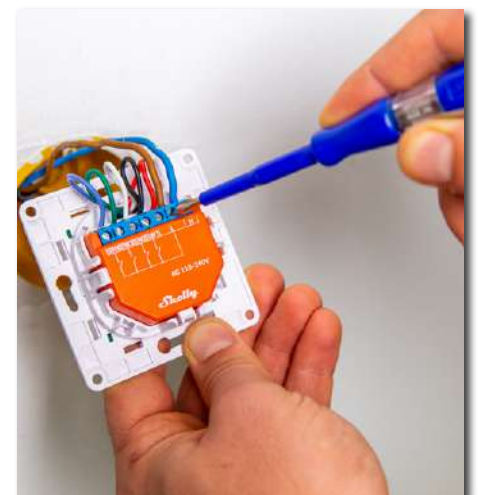

Shelly[®] 1



USE THE POWER OF MONGOOSE OS TO MAKE YOUR OWN APPLICATION



MAKE YOUR ARDUINO PROJECT LIVE AND USABLE IN YOUR AUTOMATION PROJECT



SHARE YOUR EXPERIENCE WITH DEVELOPERS OVER THE WORLD



USE OUR REST API TO CONNECT SHELLY 1 OS WITH YOUR EXISTING HOME AUTOMATION SYSTEM

{ REST }



Mobile App Control

Turn appliances on/off directly from your smartphone or tablet.



Wi-Fi Connected

Simply connect Shelly to your Wi-Fi network and begin the ultimate experience by controlling your home with your phone.



Home assistant compatible

Control your appliance with your voice. Shelly 1 OS is Google home and Amazon Echo compatible.



Weekly Scheduling

Create custom daily schedules for your devices.



Following the Sunlight

Shelly 1 OS can automatically turn on/off based on the sunrise and sunset hours.



Up To 3500W

With Shelly 1 OS you can control a wide range of devices and appliances.



Free Cloud

All you need to manage your Shelly 1 OS is a smartphone and the Shelly Cloud free mobile application.



Countdown timer

No more forgotten turned on appliances. The integrated countdown timer can automatically switch off your oven after an hour.

WIFI-OPERATED RELAY SWITCH FOR LIGHTS AND APPLIANCES AUTOMATION

The Wi-Fi Relay Switch Shelly 1 OS is intended to be mounted into a standard in-wall console, behind power sockets and light switches in order to control the electric power through it.

TECHNICAL SPECIFICATIONS

Power supply	<ul style="list-style-type: none"> • 110-240V, 50/60Hz AC • 24-60V DC • 12V DC $\pm 10\%$
Max load	16A
Complies with EU standards:	<ul style="list-style-type: none"> • RE Directive 2014/53/EU • LVD 2014/35/EU • EMC 2014/30/EU • RoHS2 2011/65/EU
Working temperature	-20°C ÷ 40°C
Radio signal power	1mW
Wireless/WiFi Protocol	802.11 b/g/n (2.4 GHz)
Frequency:	2412 – 2472 MHz
Operational range (depending on local construction)	<ul style="list-style-type: none"> • up to 50 m outdoors • up to 30 m indoors
Dimensions (HxWxL)	43x38x18 mm
Electrical consumption	< 1 W
Wire cross section range	0.5 ÷ 1.5 mm ²

fig.1 Power supply: 110-240V AC

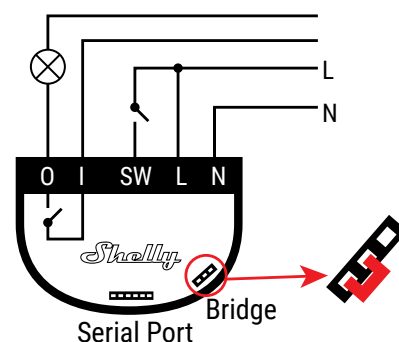
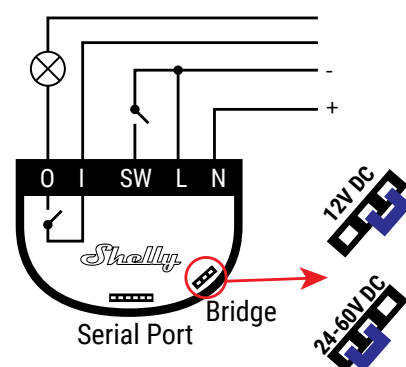

fig.2 Power supply: 12V; 24-60V DC



Legend

Device terminals:

- O:** Load circuit output terminal
- I:** Load circuit input terminal
- SW:** Switch (controlling O) input terminal
- L:** Live (110-240 VAC) terminal
- N:** Neutral terminal

Wires:

- L:** Live (110-240 VAC) wire
- N:** Neutral wire
- :** 12/24-60 VDC negative wire
- +:** 12/24-60 VDC positive wire





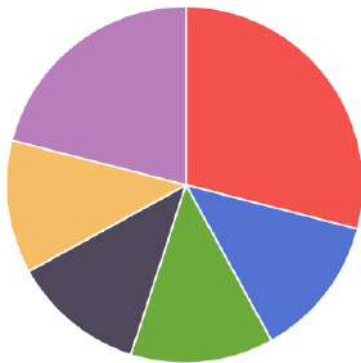

The WiFi Relay Switch Shelly 1 may control an electrical circuit up to 16A. It is intended to be mounted into a standard in-wall console, behind power sockets and light switches or other places with limited space. Shelly may work as a standalone Device or as an accessory to a home automation controller.

Shelly[®] 1PM



KEEP TRACK OF YOUR ELECTRICAL CONSUMPTION



	HEATING
	COOLING
	WATER HEATING
	APPLIANCES Includes refrigerator, dishwasher, clothes, washer and dryer
	LIGHTS
	ELECTRONICS Includes telephone and external power, adapters, consumer electronics (computer, TVs and DVD player), home and office equipment and small appliances

Thanks to its integrated power monitor, Shelly 1PM will help you keep track of the electrical consumption of your lights and appliances. The free cloud storage provide 365 days of data for analysis.



Power Metering

Shelly 1PM has an integrated precise power meter. You can measure the overall consumption of all the electric devices you are controlling.



Mobile App Control

Turn appliances on/off directly from your smartphone or tablet.



Wi-Fi Connected

Simply connect Shelly to your Wi-Fi network and begin the ultimate experience by controlling your home with your phone.



Home assistant compatible

Control your appliance with your voice. Shelly 1PM is Google home and Amazon Echo compatible.



Weekly Scheduling

Create custom daily schedules for your devices.



Following the Sunlight

Shelly 1PM can automatically turn on/off based on the sunrise and sunset hours.



Up To 3500W

With Shelly 1PM you can control a wide range of devices and appliances.



Free Cloud

All you need to manage your Shelly 1PM is a smartphone and the Shelly Cloud free mobile application.



Countdown timer

No more forgotten turned on appliances. The integrated countdown timer can automatically switch off your oven after an hour.

CONTROL ANY ELECTRICAL APPLIANCE AND MEASURE ITS CONSUMPTION

The Wi-Fi Relay Switch Shelly 1PM is intended to be mounted into a standard in-wall console, behind power sockets and light switches in order to control the electric power through it.

TECHNICAL SPECIFICATIONS

Power supply	<ul style="list-style-type: none"> • 110-240V, 50/60Hz AC • 24-60V DC
Max load per channel	16A
Complies with EU standards	<ul style="list-style-type: none"> • RE Directive 2014/53/EU • LVD 2014/35/EU • EMC 2014/30/EU • RoHS2 2011/65/EU
Working temperature	-20°C ÷ 40°C
Radio signal power:	1mW
Wireless/WiFi Protocol	802.11 b/g/n (2.4 GHz)
Frequency:	2412 - 2472 MHz
Operational range (depending on local construction)	<ul style="list-style-type: none"> • up to 50 m outdoors • up to 30 m indoors
Dimensions (HxWxL)	43x38x18 mm
Electrical consumption	< 1 W
Wire cross section range	0.5 ÷ 1.5 mm ²

For developers

Shelly 1PM comes with a programming/debug header which can be used to flash alternative firmware on the device. It has an ESP8266 inside, with a 2MB flash chip. A USB-to-UART adapter is needed as well as a reliable 3.3V with at least 350 mA drive capability. The following diagram shows the device pinout:

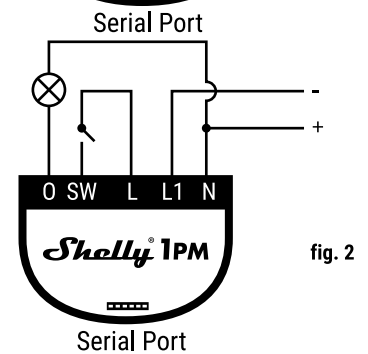
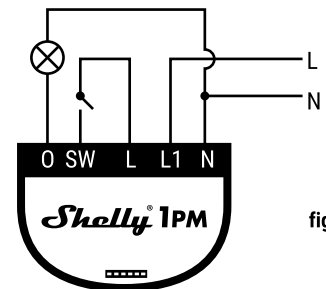
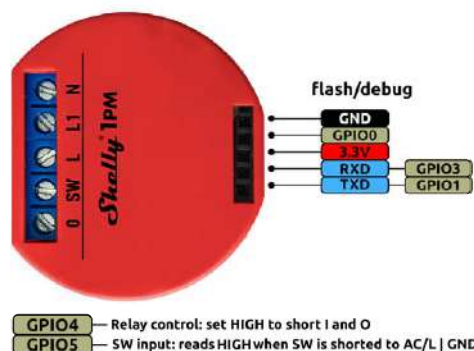

Legend

Device terminals:

- O: Load circuit output terminal
- SW: Switch (controlling O) input terminal
- L: Live output for the switch terminal
- L1: Live (110-240 VAC) terminal
- N: Neutral terminal

Wires:

- L: Live (110-240 VAC) wire
- N: Neutral wire
- : 12/24-60 VDC negative wire
- +: 12/24-60 VDC positive wire



Shelly[®] 2.5



SHELLY 2.5 CONNECTING EVERYTHING



SHELLY 2.5 IS 39x36x17 mm



MANAGE YOUR COOLING AND HEATING SYSTEM REMOTELY



Wi-Fi Connected

Shelly 2.5 can connect to any Wi-Fi network or can operate as an Access Point.



2 Channels

Maximum load current per output: 10A/230V, 50/60Hz. You can control a wide range of home appliances and office equipment.



Power Metering

Shelly 2.5 has an integrated precise power meter. You can measure the overall consumption of all the electric devices you are controlling.



Energy Efficient

Manage and control heating radiators and air conditioners, in order to reduce energy consumption related to heating/cooling with up to 30%.



Mobile app control

You can turn on and off your appliances from anywhere in the world.



Countdown timer

No more forgotten turned on appliances. The integrated countdown timer can automatically switch off your oven after an hour.

EASY INSTALLATION



SMALL

Shelly 2.5 is 39x36x17mm. You can install Shelly 2.5 into the wall under the power socket or a standard light switch. For roller-shutters, barriers, etc., 3-wire installation is required.

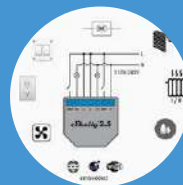

EASY WIRING

And retrofit! Install the Shelly 2.5 relays to your existing electric circuits, for 3 minutes each, and make your home smart and energy efficient.



PRACTICAL

Shelly 2.5 can be installed on a DIN into your electricity box, right next to the breakers.

WIFI-OPERATED DOUBLE RELAY SWITCH & ROLLER SHUTTER

Control a wide range of home appliances and office equipment (lights, power lines, garage doors, curtains, security systems, heating radiators, air conditioners, etc.) from anywhere with the smallest WiFi-operated double relay switch with roller shutter functionality in the world - **Shelly 2.5**.

TECHNICAL SPECIFICATIONS

Power supply	Shelly 2.5 is compatible with all major international voltage standards 110-230V, 50/60Hz AC
2 Channels	Maximum load current per output: 10A/230V, 50/60Hz. You can control a wide range of home appliances and office equipment.
Complies with EU standards	<ul style="list-style-type: none"> • RE Directive 2014/53/EU • LVD 2014/35/EU • EMC 2014/30/EU • RoHS2 2011/65/EU
Working temperature	-20°C ÷ 40°C
Radio signal power	1mW
Wireless/WiFi Protocol	WiFi 802.11 b/g/n Shelly 2.5 can connect to any Wi-Fi network or can operate as an Access Point
Frequency	2412 - 2472 MHz
Operational range (depending on local construction)	<ul style="list-style-type: none"> • up to 50 m outdoors • up to 30 m indoors
Dimensions (HxWxL)	39x36x17 mm
Electrical consumption	< 1 W
Wire cross section range	0.5 ÷ 1.5 mm ²

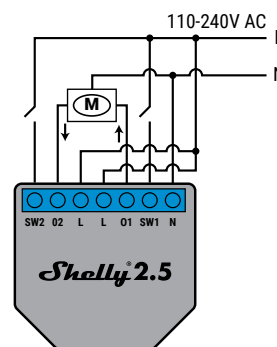
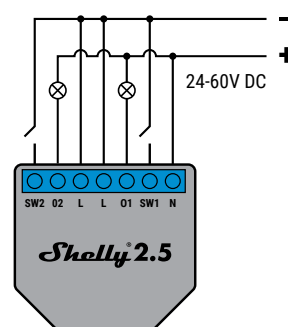
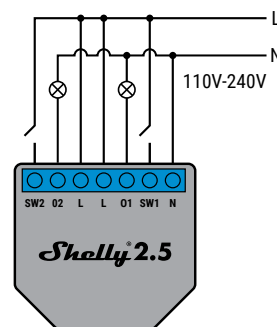

Legend:

Device terminals:

- SW2:** Switch (controlling O2) input terminal
- O2:** Load circuit 2 output terminal
- L:** Live (110-240 VAC) terminals
- O1:** Load circuit 1 output terminal
- SW1:** Switch (controlling O1) input terminal
- N:** Neutral terminal

Wires:

- L:** Live (110-240 VAC) wire
- N:** Neutral wire
- :** 24-60 VDC negative wire
- +:** 24-60 VDC positive wire

Shelly[®] dimmer2

SMALL SIZE FULL OF FUNCTIONALITIES



Intelligently designed to fit in most standard electrical boxes and switches. Shelly Dimmer 2 is a tiny device offering an array of dimming functionalities.



No additional controller

Shelly Dimmer 2 uses your home WiFi network, no additional controllers are needed.



On/off and dimming function

With Shelly Dimmer 2 you can turn on/off or use dimming function to set your lights to your preference.



Overheating protection

Internal temperature sensor for overheating protection.



Support 100-240V~ 50/60Hz

With Shelly Dimmer 2 you can use incandescent and halogen lights: 10-220W, dimmable LED lights: 50-200VA / 10W – 200W or resistive-inductive loads: ferromagnetic transformers 50-150VA.



Free Cloud

All you need to manage your Shelly Dimmer 2 is a smartphone and the Shelly Cloud free mobile application.

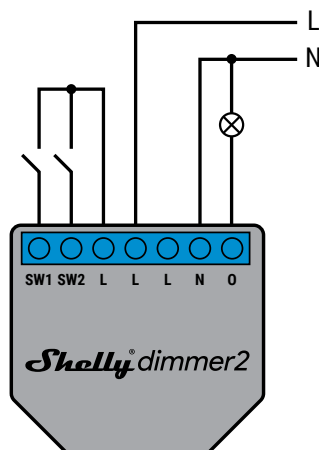

Standard wiring
with neutral

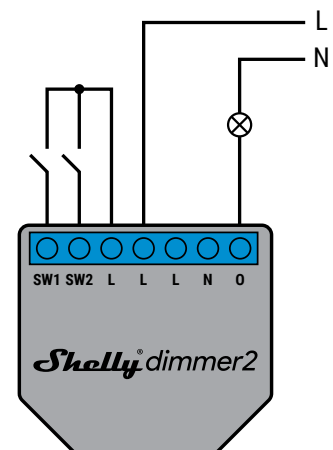

No neutral
wiring

CREATE THE PERFECT HOME ATMOSPHERE THAT SUITS YOUR MOOD

Dimming without a neutral line. We developed Shelly Dimmer 2 to be able to cover all possible electrical installations all over the world. Shelly Dimmer 2 can be used in houses where the neutral line is missing and provide a full set of dimming functionalities.

TECHNICAL SPECIFICATIONS

Power Supply	110-230V, 50/60Hz
Can work without neutral line	Yes
Complies with EU standards	<ul style="list-style-type: none"> • RE Directive 2014/53/EU • LVD 2014/35/EU • EMC 2014/30/EU • RoHS2 2011/65/EU
Working temperature:	0 ÷ 35°C
Radio signal power	1mW
Radio protocol	WiFi 802.11 b/g/n
Frequency	2412 - 2472 MHz
Operational range (depending on local construction)	<ul style="list-style-type: none"> • up to 50 m outdoors • up to 30 m indoors
Dimensions	43x37x14 mm
Electrical consumption	< 1 W
Wire cross section range	0.5 ÷ 1.5 mm ²

Use with any bulb you want

Shelly Dimmer 2 can be used with a variety of light bulbs. From halogen and incandescent lights to dimmable LED and resistive - inductive load ferromagnetic transformers.

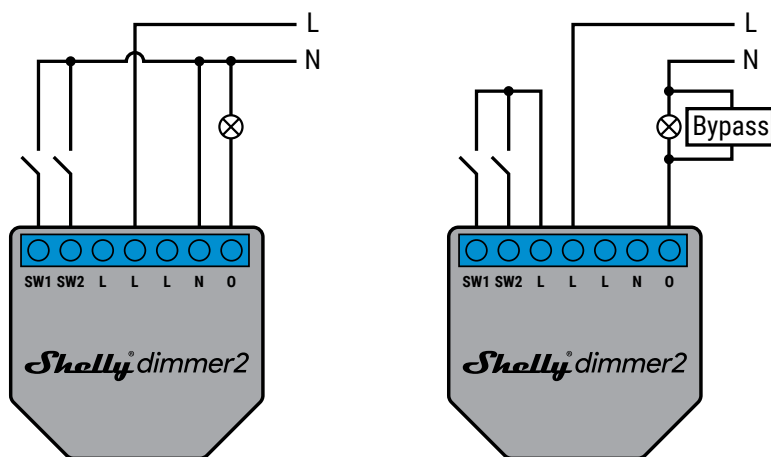

Standard wiring with neutral and SW connected to neutral

No neutral wiring with no minimum load requirements

Legend

Device terminals:

- SW1:** Switch 1 input terminal
- SW2:** Switch 2 input terminal
- L:** Live (110-240 VAC) terminals
- N:** Neutral terminal
- O:** Load circuit output terminal

Wires:

- L:** Live (110-240 VAC) wire
- N:** Neutral wire

Shelly[®] RGBW2



POWER ON



Get a 110–220V AC to 12-24V DC

SHELLY RGBW2



Connect Shelly RGBW2 to the power transformer

LED STRIPS AND/OR BULBS



Support any 12V or 24V White, RGB, RGBW led strips and 12/24V led bulbs, with up to 288W combined power



Wireless

No HUB required – Connect Shelly RGBW2 directly to your Wi-Fi at home.



Weekly Schedules

Choose a time and set your hidden lighting to turn on/off or change color.



Sunrise/Sunset Schedules

Shelly RGBW2 will automatically follow the sunrise and sunset and can control your lighting accordingly.



Color Effects

The 6 unique colorful effects will set the mood for your party or help you relax at home.



Control Remotely

Control the LED lighting at home, no matter where you are. Now you won't be leaving the lights on and your home won't welcome you in darkness.



Highly Compatible

Compatible with Android, iOS, Amazon Alexa and Google Assistant.



Support 12V or 24V

With Shelly RGBW2 you can use White, RGB, RGBW led strips and 12/24V led bulbs, with up to 288W combined power.



ON/OFF and Dimming Function

No more forgotten turned on appliances. The integrated count-down timer can automatically switch off your lights after an hour.

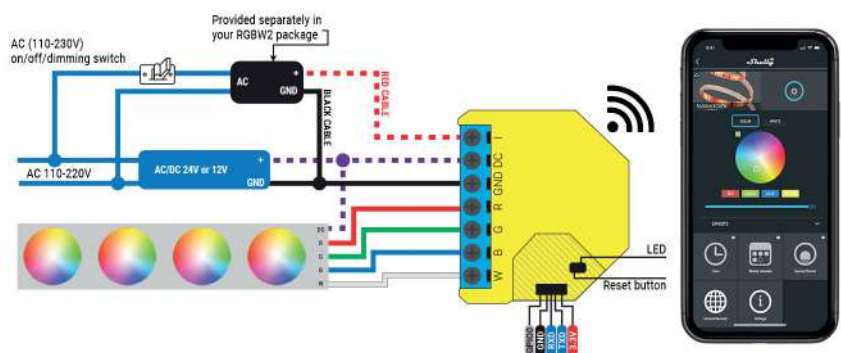

WIFI RGBW LED CONTROLLER

Make your LED strips smart without additional investment. **Shelly RGBW2** connects like any LED controller. The main benefit is that you will be able to control your light directly from your mobile phone.

TECHNICAL SPECIFICATIONS

Interfaces	
Output interface	4 ways PWM: R/G/B/W 3 ways PWM: R/G/B 4 ways PWM: 4x White strips or 4x12/24v led bulbs
Interface	Reset button, AC 230V switch input
AC switch	On/Off and Dimming function
WiFi Parameters and Features	
WiFi work mode	STA/AP/STA+AP/Smart Config
Security Specialty	None, WEP, WPA-PSK, WPA2-PSK (TKIP/AES)
WiFi Standard	IEEE 802.11b/g/n
WiFi Power	802.11b (CCK) 11Mbps: 20+/-1.5dBm
	802.11g (OFDM) 54Mbps: 15.5+/-1.5dBm
	802.11n(HT20@MCS7) 72.2Mbps: 14.5+/-1.5dBm
Frequency	2.4GHz-2.5GHz (2400M-2483.5M)
Antenna	Embedded
Power Input/output	
DC Power Input	12-24V
DC Power Output 12V	144W - combined power; 45W - per channel
DC Power Output 24V	288W - combined power; 90W - per channel
Standby Current	≤50mA
Work environment	
Working temperature	-20°C ÷ 40°C
Work humidity	5% to 95% (No condensing)
WiFi Range	Indoor: 35m, Outdoor: 60m (depending on the environment)
Dimensions (HxWxL)	43x38x14 mm
Wire cross section range	0.5 ÷ 1.5 mm ²

- Focus on 8~36W lamps such as drop-light, ceiling lamp, table lamp, down lamp or other
- Support 5 ways PWM, applied to control 5 colors LED(R/G/B/CW/WW),
- Offers mobile phone App, supporting iOS and Android
- Configure network via the mobile App
- Supports local and remote control
- Supports Weekly Schedules
- Supports Sunrise/Sunset time based Schedules
- 6 color effects

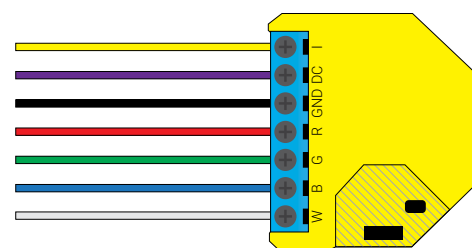

LEGEND:

- AC or DC on/off/dimming switch
- + 12/24V DC
- - 12/24V DC
- Red Light
- Green Light
- Blue Light
- White Light

Shelly[®] 1L



SUPPORTED LOAD TYPE (WITH AND WITHOUT NEUTRAL):

- ✓ Resistive (lights, electric heaters)
- ✓ Inductive (Led Lights, Transformers, Fan, Motors)
- ✓ Capacitive (motor starting capacitors, generators, and synchronous motors)

SUPPORTED LIGHT TYPES:

- ✓ Incandescent lamps
- ✓ Fluorescent lamps.
- ✓ Halogen lamps.
- ✓ Dimmable LED
- ✓ Non Dimmable LED
- ✓ Fluorescent tubes
- ✓ Neon lamps.



Wi-Fi Connected

No HUB required – Connect Shelly 1L directly to your Wi-Fi at home



No neutral required

Power on the device and control your light, fan, or other appliances only by Live wire, no neutral required to be connected to the device.



Highly compatible

Compatible with Android, iOS, Amazon Alexa and Google Assistant. Control your appliance with your voice.



Overheating protection

In case of high temperature Shelly1L will switch OFF the output to protect itself and your home appliances.



Following the Sunlight

Shelly 1L can automatically follow the sunrise and sunset and control your lighting accordingly.



Weekly Scheduling

Choose a time and set your lighting to turn on/off or dim precisely when you want it to.



Rest API

Use our REST API to connect Shelly 1L to your existing home automation system.



MQTT enabled

Easily integrate Shelly1L to your existing home server using MQTT or CoAP protocol.

DEVICE PINOUT

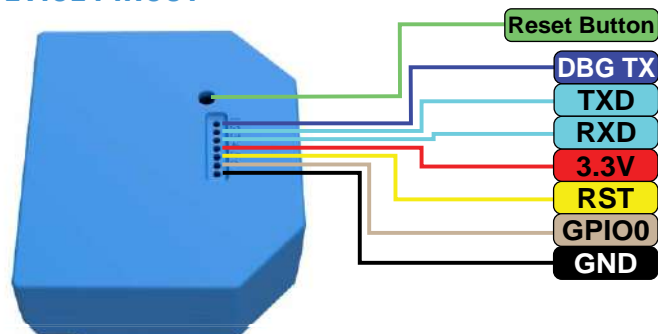

THE BEST RETROFIT DEVICE EVER MADE

No electrical wiring changes needed Shelly1L can convert any existing wall into a smart switch. You don't need to change the wiring, to run new cables, or anything else. Just put the shelly behind the existing wall switch.

No neutral line required. Many light switches are wired with no neutral present, which makes them difficult to automate. Shelly1L handles this problem because it only needs the hot line.

TECHNICAL SPECIFICATIONS

Power supply	• 110-230V, 50/60Hz
Power supply DC	No
Device temperature protection	Yes
Complies with EU standards:	<ul style="list-style-type: none"> • RE Directive 2014/53/EU • LVD 2014/35/EU • EMC 2014/30/EU • RoHS2 2011/65/EU
Working without a neutral line	Yes
Channels	Channel
Maximum load	4.1A (5A for short operation)
Minimum load – no neutral connected, without bypass	20W resistive load
Operational temperature	-20°C ÷ 40°C
Device power consumption	1W
Wireless/WiFi Protocol	802.11 b/g/n (2.4 GHz)
Frequency	2412 - 2472 MHz
Radio signal power	1mW
Operational range (depending on local construction)	<ul style="list-style-type: none"> • up to 50 m outdoors • up to 30 m indoors
Dimensions (HxWxL)	43x38x14 mm
Wire cross section range	0.5 ÷ 1.5 mm ²

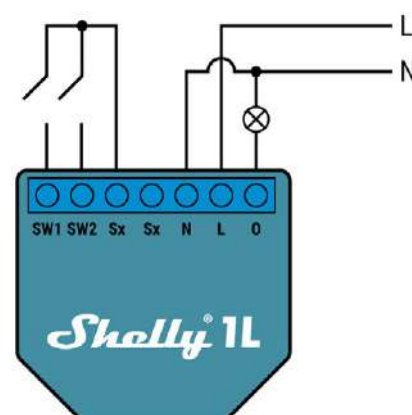

Wiring with neutral

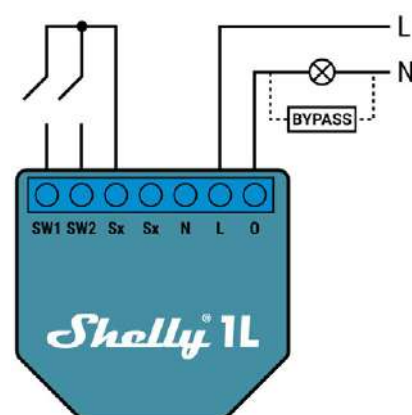

Wiring without neutral

Legend:*

Device terminals:

SW1: Switch 1 input terminal

SW2: Switch 2 input terminal

Sx: Signal for switch terminal

N: Neutral terminal

L: Live (110-240 VAC) terminals

O: Load circuit output terminal

Wires:

L: Live (110-240 VAC) wire

N: Neutral wire

* When using the device without neutral, Shelly 1L requires at least 20W of power consumption, in order to operate. If the connected light has a smaller power consumption, then Shelly Bypass is required for the operation of the Device! Shelly Bypass is accessory that will be sold separately!

Shelly[®] EM



MEASUREMENTS

- ✓ 2x Power(W)
- ✓ 2x Current(A)
- ✓ 2x Energy(Wh)
- ✓ 2x Load quality
- ✓ 1x Voltage(V)



ADDITIONAL FEATURES

- ✓ 365 days built-in energy history
- ✓ Relay output for contactor control



Wi-Fi Connected

Shelly EM can connect directly to any Wi-Fi network, no HUB required or can operate as an Access Point.



Power Supply

Shelly EM is compatible with all major international voltage standards.



Dual Power Metering

Shelly EM can monitor in real time the energy consumption simultaneously in 2 circuits on the same phase. (up to 120A each).



Contactor Control

2A / 230V 50/60Hz. Shelly EM has integrated relay output made for contactor control.



Mobile app control

Turn devices on/off directly from your smartphone or tablet. You can manage Shelly EM output from Shelly app, MQTT or Rest API.



Overconsumption and Over Energy Protection

No more forgotten turned on appliances. The integrated count-down timer can automatically switch off your oven after an hour.



Embedded Web Server

Turn on/off Shelly devices directly from its interface without the need of any additional controller or hub, thanks to the embedded web.



Sunrise/Sunset Schedules

Shelly EM can automatically turn on/off based on the sunrise and sunset hours.



Weekly Schedules

Choose a time and create custom daily schedules for your devices.

WIFI-OPERATED ENERGY METER AND CONTACTOR CONTROL

With **Shelly EM** you can measure how much energy your solar system produces.

TECHNICAL SPECIFICATIONS

Power supply	110-230V, 50/60Hz AC
Power metering	Two channels, up to 120A each
Consumption history	365 days built-in energy history (Wh)
Contactor control	Maximum load: 2A / 230V 50/60Hz.
Complies with EU standards:	<ul style="list-style-type: none">• RE Directive 2014/53/EU• LVD 2014/35/EU• EMC 2014/30/EU• RoHS2 2011/65/EU
Working temperature	0°C ÷ 40°C
Radio signal power:	1mW
Wireless/WiFi Protocol	802.11 b/g/n (2.4 GHz)
Frequency	2412 - 2472 MHz
Operational range (depending on local construction)	<ul style="list-style-type: none">• up to 50 m outdoors• up to 30 m indoors
Dimensions (HxWxL)	39x36x17 mm
Electrical consumption:	< 1 W
Additional features	<ul style="list-style-type: none">• Overpower shutdown• Consumption limit
Wire cross section range	0.5 ÷ 1.5 mm ²



CONTROL 120A SAFE AND EASY

Shelly EM has integrated relay output made for contactor control

- **Remote control from anywhere**

You can manage ShellyEM output from Shelly app, MQTT or Rest API

- **Overpower Control**

Automatic shutdown or notification when reaching current consumption limit.

- **Turn off when total consumption is reached**

Automatic shutdown when power is reached.

- **Weekly scheduling by time or sun position**

Auto turn on and off by hour or sunset and sunrise.

Shelly® 3EM



- ✓ Precise 3-phase energy metering
- ✓ Up to 120A per phase
- ✓ Integrated 10A contactor control
- ✓ Solar and Wind power compatible
- ✓ Factory calibrated with over 99% accuracy
- ✓ DIN mountable
- ✓ Wi-Fi enabled
- ✓ Cloud and MQTT Enabled
- ✓ 365 days power consumption history



Wi-Fi connected

Shelly 3EM can be connected to any Wi-Fi network or can operate as an Access Point.



Power supply

Each phase of Shelly 3EM must be 110-230V \pm 10, 50/60Hz AC.



Monophase systems

Shelly 3EM can also monitor monophase electrical systems with up to 3 points simultaneously.



Contactor control

Shelly 3EM has an integrated 10A relay output for contactor control.



Mobile app control

Turn Shelly 3EM on/off directly from your smartphone or tablet. You can manage Shelly 3EM's output from the Shelly Cloud app, MQTT or Rest API.



Overconsumption and overpower protection

Shelly 3EM can automatically turn off the whole circuit if consumption or energy (pre-paid energy option) reaches the set limit.



Embedded web server

Turn on/off Shelly 3EM's contactor output directly, without the need of any additional controller or hub.



Sunrise/sunset schedules

Shelly 3EM can automatically turn on/off the power based on the sunrise/sunset hours.



Weekly schedules

Choose a time and create custom daily schedules for your Shelly 3EM.

WIFI-OPERATED 3 PHASE ENERGY METER AND CONTACTOR CONTROL

Shelly 3EM has integrated relay output which can be used for contactor control.

TECHNICAL SPECIFICATIONS

Power supply	110-230V, 50/60Hz AC
Power metering	3 channels, up to 120A each
Consumption history	365 days built-in energy history (Wh)
Contactor control	Maximum load 10A
Complies with EU standards	<ul style="list-style-type: none"> • RE Directive 2014/53/EU • LVD 2014/35/EU • EMC 2014/30/EU • RoHS2 2011/65/EU
Working temperature	-20°C ÷ 40°C
Radio signal power	1mW
Wireless/WiFi Protocol	802.11 b/g/n (2.4 GHz)
Frequency	2412 - 2472 MHz
Operational range (depending on local construction)	<ul style="list-style-type: none"> • up to 50 m outdoors • up to 30 m indoors
Dimensions (HxWxD)	73x22x58 mm
Electrical consumption	< 1 W
Additional features	<ul style="list-style-type: none"> • Overpower shutdown • Consumption limit

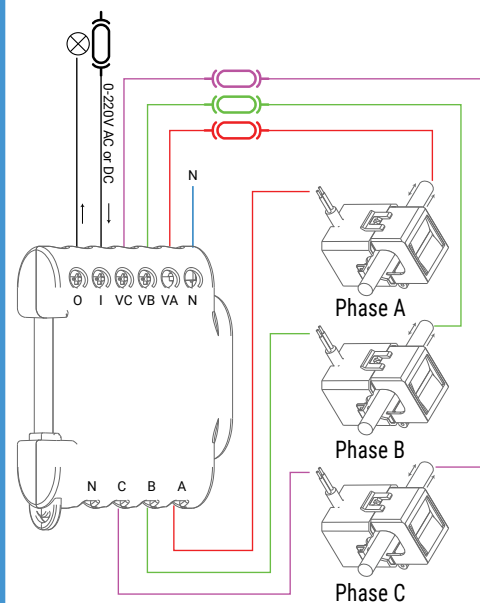

Shelly[®] UNI



DEVICE PINOUT

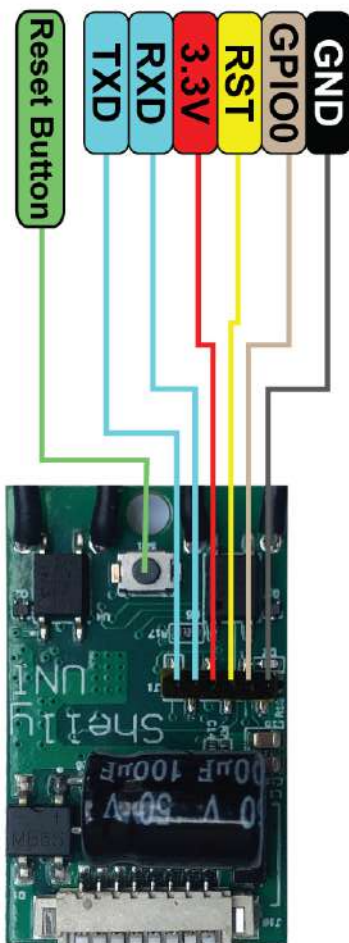

Wi-Fi Connected

No HUB required – Connect Shelly Bulb directly to your Wi-Fi at home.



Universally flexible power supply

Shelly UNI can be powered with the wide range of 12V-36V DC and 12V-24V AC.



Universal ADC

The ADC range can measure any voltage from 0 to 30 VDC. Dual ranges from 0-12V and 12-30V give exceptionally high accuracy.



Universal temperature & humidity sensors

Shelly UNI supports up to 3xDS18B20 temperature sensors or 1X humidity sensors, making it possible to trigger outputs, local and cloud scenes.



Universal digital inputs

Includes 2 digital inputs, which can be support differing voltages and work separately from 2.2-36V DC and 12-24V AC.



Potential Free Outputs

2 potential free outputs (dry contacts), up to 36V DC or 24V AC, providing the ability to switch a voltages different from the device power supply one.



Universal protocols

Out of the box, Shelly UNI supports REST, MQTT, CoAP, Alexa, Google Home, and Samsung Smart Things, making it highly compatible with all major home automation platforms.



Universal resistance

Even though there is no plastic shell, the transparent insulation layer over the chip protects it from high humidity, dust, and the threat of short circuits during its long working hours.

THE INTELLIGENT WI-FI OPERATED IMPLANT

Make any old appliance smart! Shelly UNI is the smallest universal module with two available digital inputs and potential-free outputs, providing endless functionalities.

TECHNICAL SPECIFICATIONS

Power supply	12V – 24V AC, 12V – 36V DC
Inputs	2 Separated digital inputs from 2.2-36V DC and 12-24V AC
Outputs	2 Potential free outputs up to 36V DC and 24V AC, max 100 mA each
Power measurement	1 ADC – dual ranges from 0-12V and 0-30V
Channels	2
Working temperature	-20°C ÷ 40°C
Power consumption	< 1W
Complies with EU standards	<ul style="list-style-type: none">• RE Directive 2014/53/EU• LVD 2014/35/EU• EMC 2014/30/EU• RoHS2 2011/65/EU
Radio signal power	1mW
Radio protocol	WiFi 802.11 b/g/n
Frequency	2412 - 2472 MHz
Operational range (depending on local construction)	<ul style="list-style-type: none">• up to 50 m outdoors• up to 30 m indoors
Dimensions	20x33x13 mm

- No HUB required.
- Wide range of voltage support.
- 2 digital inputs
- 2 potential-free outputs
- ADC range can measure any voltage from 0 to 30 VDC
- Supports up to 3xDS18B20 temperature sensors or 1X humidity sensors
- Transparent insulation layer over the chip protects it from high humidity, dust, and the threat of short circuits
- It can be integrated with all other Shelly devices.
- Compatible with Android, iOS, Amazon Alexa, Google Assistant, and home automation servers using MQTT, CoAP, and REST API.
- Easily make your Arduino project live and usable in your automation project.

Shelly[®] PLUG



SHELLY PLUG SAVES YOU ENERGY AND MONEY



WITH SHELLY PLUG YOU CAN CONTROL ANY DEVICE AT YOUR HOME FROM ANYWHERE



WITH SHELLY PLUG YOU MAY OPTIMIZE YOUR TIME



Wi-Fi Connected

Shelly™ Plug can connect to any Wi-Fi network or can operate as an Access Point.



Power Consumption

Shelly™ Plug has an integrated precise power meter. You can measure the overall consumption of all the electric devices you are controlling.



Free Cloud

All you need to manage your Shelly Plug is a smartphone and the Shelly Cloud free mobile application.



Follow the sunlight

Shelly Plug can automatically turn on/off based on the sunrise and sunset hours.



Weekly scheduling

Create custom daily schedules for your devices.



Mobile app control

You can turn on and off your appliances from anywhere in the world.



Countdown timer

No more forgotten turned on appliances. The integrated countdown timer can automatically switch off your oven after an hour.



Up To 3500W

With Shelly Plug you can control wide range of devices and appliances.



Highly compatible

Compatible with Android, iOS, Amazon Alexa and Google Assistant.

SMART WIFI-OPERATED PLUG WITH POWER MEASUREMENTS AND 16A MAX LOAD

Shelly Plug automatically monitors and controls lightning, heating and any other connected electrical appliance in your house, no matter where you are. When an electric appliance or a lamp is plugged into the Shelly Plug, you can switch it on and off through the Shelly Cloud mobile application. You can do it anytime and from anywhere.

TECHNICAL SPECIFICATIONS

Power supply	Input 110-230V, 50/60Hz AC
Max load	16A / 230V
Complies with EU standards	<ul style="list-style-type: none">• RE Directive 2014/53/EU• LVD 2014/35/EU• EMC 2014/30/EU• RoHS2 2011/65/EU
Working temperature	-20°C ÷ 40°C
Radio signal power	1mW
Wireless/WiFi Protocol	802.11 b/g/n (2.4 GHz)
Frequency	2412 - 2472 MHz
Operational range (depending on local construction)	<ul style="list-style-type: none">• up to 50 m outdoors• up to 30 m indoors
Dimensions (HxWxL)	98x56x35 mm
Processor (CPU)	Texas Instruments CC3200
Remote Control	Trough mobile app & web interface
Compatibility	Android (4.2+) & iOS (8+), web browsers
Languages	Multiple trough mobile app & web interface
Electrical consumption	< 1 W

- Control through WiFi from a mobile phone, PC, automation system or any other device supporting HTTP and/or UDP protocol.
- Microprocessor management.
- Controlling elements: 1 relay.
- Shelly may be controlled by the integrated button.

Shelly[®] PLUG S



SHELLY PLUG S CONTROL ANY DEVICE AT YOUR HOME FROM ANYWHERE



WITH SHELLY PLUG S YOU CAN CREATE YOUR OWN SCENE THAT WILL SEND YOU A NOTIFICATION DIRECTLY TO YOUR PHONE



WITH SHELLY PLUG YOU MAY CAN OPTIMIZE YOUR TIME



Wi-Fi Connected

Just connect Shelly PLUG S to your Wi-Fi network and begin the ultimate experience of controlling your home with your phone.



Power Consumption

Shelly Plug will power off any appliance if the predefined power consumption level is reached.



Free Cloud

All you need to manage your Shelly PLUG S is a smartphone and the Shelly Cloud free mobile application.



Follow the sunlight

Shelly Plug can automatically turn on/off based on the sunrise and sunset hours.



Weekly scheduling

Create custom daily schedules for your devices.



Mobile app control

You can turn on and off your appliances from anywhere in the world.



Countdown timer

No more forgotten turned on appliances. The integrated countdown timer can automatically switch off your oven after an hour.



Up To 2500W

With Shelly Plug you can control wide range of devices and appliances.



Highly compatible

Compatible with Android, iOS, Amazon Alexa and Google Assistant.

COMPACT WI-FI SMART PLUG WITH POWER METERING

Shelly Plug S fits everywhere and is the most intelligent Wi-Fi plug ever.

It automatically controls lightning, heating and any other connected electrical appliance in your house.

TECHNICAL SPECIFICATIONS

Power supply	Input 110-230V, 50/60Hz AC
Max load	12A / 230V, 50/60Hz
Complies with EU standards:	<ul style="list-style-type: none">• RE Directive 2014/53/EU• LVD 2014/35/EU• EMC 2014/30/EU• RoHS2 2011/65/EU
Working temperature	-20°C ÷ 40°C
Radio signal power	1mW
Wireless/WiFi Protocol	802.11 b/g/n (2.4 GHz)
Frequency	2412 - 2472 MHz
Operational range (depending on local construction)	<ul style="list-style-type: none">• up to 50 m outdoors• up to 30 m indoors
Dimensions (HxWxL)	70x44x44 mm
Processor (CPU)	Texas Instruments CC3200
Remote Control	Through mobile app & web interface
Compatibility	Android (4.2+) & iOS (8+), web browsers
Languages	Multiple through mobile app & web interface

- Control through WiFi from a mobile phone, PC, automation system or any other device supporting HTTP and/or UDP protocol.
- Microprocessor management.
- Controlling elements: 1 relay.
- Shelly may be controlled by the integrated button.



Easy installation

1. Plug Shelly in to your existing power socket.
2. Take your smartphone and add the Plug to Shelly Cloud application.
3. Connect your home appliances and enjoy.

Shelly[®] button 1



1 BUTTON - 4 ACTIONS

No more stressful bright light during dark hours early in the morning. Set your custom schedule and choose soft and low light while it is still dark outside when.

- 1X - Bedroom light On/Off
- 2X - Blinds are closed
- 3X - Turn fan On/Off
- Long push - Turn Off all lights



No additional controller

Shelly Button 1 uses your home WiFi network, no additional controllers are needed.



Built-in Battery

Shelly Button 1 has built-in rechargeable battery allowing more than 3000 actions per charge.



Color hints

A different color response indication for different situations.

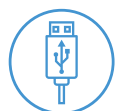

USB charging

You can charge Shelly Button 1 with Micro-B type USB cable.



Low-battery alarm

You can set Shelly Button 1 to inform you when the battery levels are low.



Quick response

Response time of less than 2s on battery and 0,1s on USB power.



Highly compatible

Shelly Button1 is Cloud connected but can also be connected via MQTT, CoAP, REST API.

CONTROL EVERYTHING WITH JUST A CLICK

We developed Shelly Button to help you easily activate or deactivate any device or scene manually with just a click. Additionally, Shelly Button is so tiny it can be put and carried around anywhere. The button is battery-powered, and you can put it in your bag, laptop case, or even in your pocket and use it whenever and wherever you need it.

TECHNICAL SPECIFICATIONS

Power Supply	Two 3V DC - CR123A Batteries or micro USB 5V
Battery Lifespan	3000 actions per charge
Complex scenes control	Activate or deactivate synchronized actions of several Shelly devices
Dimming	Yes
Complies with EU standards	<ul style="list-style-type: none">• RE Directive 2014/53/EU• LVD 2014/35/EU• EMC 2014/30/EU• RoHS2 2011/65/EU
Working temperature	-40 ÷ 40°C
Radio signal power	1mW
Radio protocol	WiFi 802.11 b/g/n
Frequency	2412 - 2472 MHz
Operational range (depending on local construction)	<ul style="list-style-type: none">• up to 50 m outdoors• up to 30 m indoors
Dimensions	45x45x16 mm

SMALL AND MOBILE

Thanks to its small size, Shelly Button 1 can fit in every pocket!



Shelly[®] MOTION

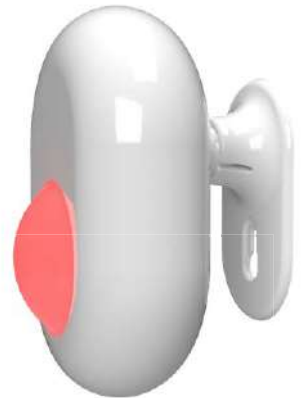

COMPATIBLE WITH OTHER DEVICES

Reveal the full potential of Shelly Motion by combining it with other devices from your home network! Set Shelly Motion to activate custom scenes based on hour, light, or various actions.

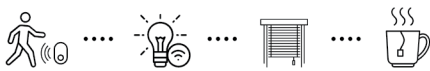

LIGHTING CONTROL

Combine Shelly lighting control devices with Shelly Motion and set the sensor to turn on the lights the moment you enter the room.



SMART SCHEDULING

Don't wake up your family during your night-time snack! Set Shelly Motion smart scheduling option to turn on the lights very dimly at late hours. That way it will not irritate your eyes or wake your loved ones.



Wi-Fi operated

Connect Shelly Motion to your Wi-Fi network. No HUB required!



Over 1 year battery life

Count on long-lasting 6500 mAh rechargeable battery.



Real time response

Response in less than 200 ms and immediate action trigger to another device.



Powerful CPU

Equipped with the lowest power consuming Wi-Fi modem in mass production in the world.



Adjustable sensitivity

256 levels of sensitivity allow adjustment of the distance and the movement to which the sensor reacts.



Tamper detection

Tamper detection and 128 levels of vibration sensitivity will notify you about the slightest vibration.

CUSTOM ACTIONS

Create the perfect morning routine! Shelly Motion can trigger other smart devices in your home network and customize the actions based on your needs. The moment you wake up, Motion sensor can trigger your rolling blinds to open and turn on the kettle for your morning tea.



ALWAYS CONNECTED WI-FI MOTION SENSOR WITH OVER 1 YEAR OF BATTERY LIFE SHELLY MOTION

A new generation Motion Sensor powered by Silicon Labs Wi-Fi IoT solutions, Shelly Motion is equipped with the lowest power consuming Wi-Fi modem in mass production in the world.

TECHNICAL SPECIFICATIONS

Battery	6500mAh 3.7V
Battery life	12 - 36 months
Complies with EU standards:	<ul style="list-style-type: none"> • RE Directive 2014/53/EU • LVD 2014/35/EU • EMC 2014/30/EU • RoHS2 2011/65/EU
Working temperature	0°C ÷ 40°C
Radio signal power	1mW
Wireless/WiFi Protocol	802.11 b/g/n (2.4 GHz)
Frequency	2412 - 2472 MHz
Operational range (depending on local construction)	<ul style="list-style-type: none"> • up to 50 m outdoors • up to 30 m indoors
Dimensions (HxWxL)	85x59x36 mm
Remote Control	Through mobile app & web interface
Compatibility	Android (4.2+) & iOS (8+), web browsers
Languages	Multiple through mobile app & web interface

Shelly Motion is high sensitive ultra-low power WiFi Motion sensor which is connected to internet 24/7 and do not need additional HUB to be used. Shelly Motion can detect and send a notification if it detects movement or turns on your lights instantly. The built-in accelerometer serves as a protection when someone tries to remove or move the device, and the built-in light sensor gives additional opportunities for automation of your home or office. Shelly Motion has a built-in 6500mAh battery that allows it to be connected to the Internet for up to 3 years without recharging, and in active transmission between 12 and 18 months.

256 LEVELS OF SENSITIVITY

256 levels of sensitivity will allow you to adjust extremely precisely the distance and the movement to which the sensor reacts.

Easily adjust Shelly Motion's sensitivity levels through the app wherever you are.



NO HUB REQUIRED

Shelly Motion can be controlled directly and without a hub through your smartphone. This way you can monitor and control your home, set scenes and adjust setting wherever you are!



Shelly[®] H&T



MONITOR HUMIDITY IN YOUR HOME



MONITOR THE TEMPERATURE OF YOUR HEATER OR AIR CONDITIONER.



MONITOR THE TEMPERATURE IN YOUR FRIDGE OR COOLER



Humidity

Monitor excessive changes in humidity. Avoid dryness and conditions for mold growth.



Temperature

Be aware of temperature fluctuations and keep your home comfortable at any time.



Battery

Battery life up to 18 months. Feel more comfortable with the long-lasting battery life.

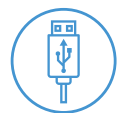

USB Add-on

You can power Shelly H&T with a USB instead of a battery using the USB power supply Add-on for Shelly H&T (sold separately, see in Accessories).



Easy control

The only thing you need to manage all your Shelly H&T devices is a mobile phone and the free Shelly Cloud application.



Wi-Fi

Connect Shelly H&T directly to your Wi-Fi.



Free history on Cloud

With Shelly H&T you can see recorded data for humidity and temperature for up to a year.

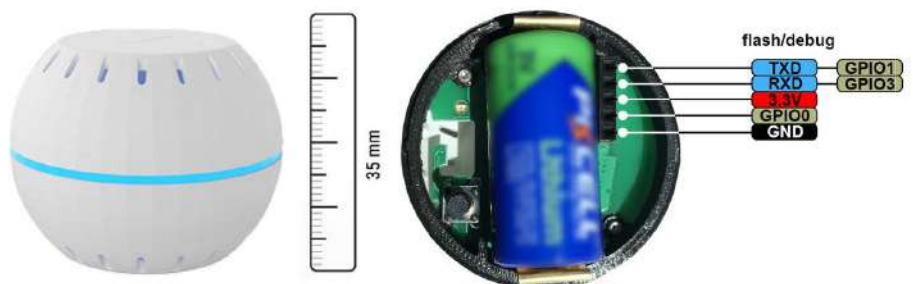

WI-FI HUMIDITY & TEMPERATURE SENSOR

Shelly H&T is the world's first Wi-Fi Humidity & Temperature sensor working over 1 year on battery

TECHNICAL SPECIFICATIONS

Battery	CR123A – 3V (NOT included)
Battery life	Up to 18 months
Electrical consumption:	<ul style="list-style-type: none">• Static $\leq 70\mu\text{A}$• Awake $\leq 250\text{mA}$
Humidity measurement range:	0~100% ($\pm 5\%$)
Temperature measurement range	$-40^{\circ}\text{C} \div 60^{\circ}\text{C}$ (Accuracy $\pm 1^{\circ}\text{C}$)
Working temperature	$-40^{\circ}\text{C} \div 60^{\circ}\text{C}$
Radio signal power	1mW
Wireless/WiFi Protocol	802.11 b/g/n (2.4 GHz)
Frequency	2412 - 2472 MHz
Operational range (depending on local construction)	<ul style="list-style-type: none">• up to 50 m outdoors• up to 30 m indoors
Dimensions (HxWxL)	35x45x45 mm
Complies with EU standards:	<ul style="list-style-type: none">• RE Directive 2014/53/EU• LVD 2014/35/EU• EMC 2014/30/EU• RoHS2 2011/65/EU

- **Shelly H&T** stores history for all temperatures and humidity in your home for years – day by day, hour by hour.
- With Shelly H&T you can **optimize power consumption** for heating and cooling your home. Do not spend extra money on power consumption if you are not at home.
- **Humidity control** is very important for your health. Keep it at its optimal levels with Shelly H&T.
- Be informed **anytime, anywhere** about everything in your home and control it just with one app without any additional equipment.



Shelly TRV



2 YEARS BATTERY LIFE

Shelly TRV has 6500 mAh rechargeable battery with up to 2 years of battery life, based on 5 months heating season.



SMART PROFILES FOR ENHANCED ENERGY EFFICIENCY

Shelly TRV supports 5 profiles with 6 temperature points to each of them. You can set custom settings and control separately each profile to ensure efficient heating usage.

SMART SCHEDULING

Ensure the efficiency of your heating system by setting Shelly TRV to maintain different levels of heating according to the hour of the day. Customers can set lower levels of heating during working hours of the day.



Wi-Fi operated

Connect Shelly TRV to your Wi-Fi network. No HUB required



Long Battery Life

Up to 2 years of battery life, based on 5 months heating season.



Rechargeable battery

Shelly TRV is equipped with fully rechargeable battery.



Precise temperature measurement

Stay informed about the temperature of your radiators no matter where you are.



Wide range of temperature control

Set your room temperature in the range of 5°C to 30°C.



Quick Profiles

Set profiles and quickly switch between pre-defined settings and schedules.



Custom schedules and scenes

Set schedules and custom scenes based on your agenda and by combining Shelly TRV with other Shelly devices.



External temperature sensor support

Connect an external Wi-Fi sensor for precise temperature measurement.



Control your boiler or pump

Control your boiler/pump automatically to save energy.



No hub required

Control directly and without a hub through your smartphone with Shelly Cloud App.



Highly compatible

Use with your preferred home automation platforms and voice assistants.

INTELLIGENT THERMOSTATIC RADIATOR VALVE FOR HIGHLY EFFICIENT HEATING MANAGEMENT

Shelly TRV replaces the old thermostatic valve in less than 5 minutes. It is enhanced with a rechargeable battery with 2 years of battery life. Shelly TRV supports 5 profiles with 6 temperature points to each of them and can activate custom scenes based on hour, light, or various actions.

TECHNICAL SPECIFICATIONS

Power supply	Built-in rechargeable battery. USB Type-C charging port (charger not included).
Battery life	Up to 2 years of battery life, based on 5 months heating season
Battery type	3.6V, 6500mAh, NCR18650BD Panasonic rechargeable battery
Power consumption	< 500 mA
Complies with EU standards:	<ul style="list-style-type: none">• RE Directive 2014/53/EU• LVD 2014/35/EU• EMC 2014/30/EU• RoHS2 2011/65/EU
Working temperature	0°C ÷ 30°C
Temperature control range	5°C ÷ 30°C
Radio signal power	1mW
Wireless/WiFi Protocol	802.11 b/g/n (2.4 GHz)
Frequency:	2412 - 2472 MHz
Operational range (depending on local construction)	<ul style="list-style-type: none">• up to 50 m outdoors• up to 30 m indoors
Dimensions (HxWxL)	62x53x94 mm

INSTALLATION IN 4 EASY STEPS

1) Remove your existing thermostatic valve of your radiator.



2) If needed, use one of adaptors included in the package.



3) Mount Shelly TRV on the radiator.



4) Connect Shelly TRV to your home Wi-Fi network and operate it through Shelly Cloud application.



Shelly® flood



INSTANT NOTIFICATIONS



DETECTS LEAKAGE

Place Shelly Flood anywhere you think there is a chance for leaks and get instant notification if water is detected.



USE YOUR FLOOR HEATING, ONLY WHEN YOU NEED IT

Shelly Flood informs you about the temperature fluctuations and help you set the right temperature for your floor heating.



Flood detection alarm

You will receive a notification if any fluid is detected by Shelly Flood.



Temperature

Be aware of temperature fluctuations and keep your floor heating at the desired temperature.



Battery

Feel comfortable with the up to 18 month battery life.



Easy control

The only thing you need to manage your Shelly Flood, is a mobile phone and the free Shelly Cloud application.



Wi-Fi

Connect Shelly Flood directly to your Wi-Fi.



Free history on Cloud

With Shelly Flood you can see recorded data for temperature up to a year.



FLOOD SENSOR WITH TEMPERATURE MEASUREMENT

With **Shelly Flood**, you can monitor the temperature of your home and receive instant notification if any liquid leakage is detected in your home

TECHNICAL SPECIFICATIONS

Battery	CR123A – 3V (NOT included)
Battery life	Up to 18 months
Electrical consumption	<ul style="list-style-type: none">• Static $\leq 5\mu\text{A}$• Awake $\leq 100\text{mA}$• Alarm $\leq 120\text{mA}$
Temperature measurement range	$-20^{\circ}\text{C} \div 50^{\circ}\text{C}$ (Accuracy $\pm 1^{\circ}\text{C}$)
Working temperature	$-40^{\circ}\text{C} \div 60^{\circ}\text{C}$
Radio signal power	1mW
Wireless/WiFi Protocol	802.11 b/g/n (2.4 GHz)
Frequency	2412 - 2472 MHz
Operational range (depending on local construction)	<ul style="list-style-type: none">• up to 30 m outdoors• up to 10 m indoors
Dimensions (HxWxL)	70x70x19 mm
Complies with EU standards	<ul style="list-style-type: none">• RE Directive 2014/53/EU• LVD 2014/35/EU• EMC 2014/30/EU• RoHS2 2011/65/EU

EASY INSTALATION

3 easy steps

1. Download the Shelly Cloud application on your smartphone or tablet
2. Connect Shelly Flood sensor to your Wi-Fi router
3. Place the devise where there is even the slightest chance of leakage.



Shelly[®] Door/Window2



LIGHTING FAST RESPONSE

For at least 1.5 seconds the sensor will send local request to another Shelly device or over MQTT. Response time depends on the local WiFi network. Signal strength, fixed IP address and fast router maintain fast association.



BATTERY LIFE

More than 12 000 wake-up and 18 months of battery life. The very low power CPU combined with 2x CR123A battery allow more than 2-year battery life thus making the Shelly Door/Window the device with longest battery life.



No additional controller

Shelly Door/Window sensor uses your home WiFi network, no additional controllers are needed.



Open-close sensor

Shelly Door/Window detects and reports the opening and closing of doors and windows.



Temperature sensor

Be aware of temperature fluctuations and keep your home comfortable at any time.



Wire free

Simply place it at your door or window.



Free Cloud

All you need to manage your Shelly Door/Window sensor is a smartphone and the Shelly Cloud free mobile application.



Battery life up to 2 years

Feel more comfortable with the long-lasting battery life.

A DOOR AND WINDOW SENSOR WITH LUX MEASUREMENT AND FAST RESPONSE

Shelly Door/Window 2 is designed to detect and report the opening and closing of doors and windows. Its compact and improved design allows it to be easily installed on any door or window, and because of its lightweight, the sensor is nearly invisible.

TECHNICAL SPECIFICATIONS

Power Supply	Two 3V DC - CR123A non-rechargeable
Battery Lifespan	up to 18 months
Complies with EU standards	<ul style="list-style-type: none">• RE Directive 2014/53/EU• LVD 2014/35/EU• EMC 2014/30/EU• RoHS2 2011/65/EU
Working temperature	-10 ÷ 50°C
Radio signal power	1mW
Radio protocol	WiFi 802.11 b/g/n
Frequency	2412 - 2472 MHz
Operational range (depending on local construction)	<ul style="list-style-type: none">• up to 50 m outdoors• up to 30 m indoors
Dimensions	Sensor 82x23x20mm Magnet 52x16x13mm
Electrical consumption	Static current: ≤10 µA Alarm current: ≤60 mA

Easy set up:

1. Attach Shelly Door/Window2 sensor to any door or window frame. The two parts of the sensor need to be close to one another.
2. Download the Shelly Cloud application on your smartphone or tablet.
3. Connect Shelly Door/Window2 to your Wi-Fi router
4. Add Shelly Door/Window2 to Shelly Cloud.



Door/window is opened



230LUX is detected



Light ON

via REST HTTP/MQTT/CoAP/Cloud

Shelly[®] GAS



LPG AND CNG VERSION

Shelly Gas comes in two versions - with LPG (Liquefied Petroleum Gas) or CNG (Compressed Natural Gas) detection. Shelly GAS supports interchangeable plug extensions in order to be compatible with different power socket standards.



INTERCHANGEABLE PLUG

Shelly GAS supports interchangeable plug extensions in order to be compatible with different power socket standards.



PROTECT YOUR HOME

Thanks to its high sensitivity, Shelly Gas will immediately detect gas leakage and release light and sound alarms, as well as will send notification to your phone in case you are away of home.



No additional controller

Shelly GAS sensor uses your home WiFi network, no additional controllers are needed.



Gas sensor

A smart gas sensor that can detect LPG or CNG and monitor your household's safety.



Flame resistant

With a flame resistant shell, Shelly GAS will be always there for you.



Wire free

Simply plug it to your power socket.



Free Cloud

All you need to manage your Shelly GAS sensor is a smartphone and the Shelly Cloud free mobile application.



GAS concentration

Low: 1800 ppm; High: 3000 ppm

SMART WI-FI GAS DETECTOR FOR LPG OR CNG

Many home appliances are dependent on natural gas, but not many homes have sensory detection for gas leaks, which can be dangerous. Shelly GAS can detect Natural Gas or Liquefied petroleum gas helping you provide additional protection for your home and family. Its long life span, little sensitivity drift, and Wi-Fi technology allow you always to know if gas is threatening your home.

TECHNICAL SPECIFICATIONS

Power Supply	110-230V, 50/60Hz
Alarm indicator	LED Flash & Sound
Alarm sensitivity	6% LEL
Valve manipulator jack output	11-13V, 500mA
Sound level	≥70dB
Gas detector	LPG or CNG
Complies with EU standards	<ul style="list-style-type: none">• RE Directive 2014/53/EU• LVD 2014/35/EU• EMC 2014/30/EU• RoHS2 2011/65/EU
Working temperature	-10 ÷ 50°C
Radio signal power	1mW
Radio protocol	WiFi 802.11 b/g/n
Frequency	2412 - 2472 MHz
Operational range (depending on local construction)	<ul style="list-style-type: none">• up to 50 m outdoors• up to 30 m indoors
Dimensions	89,5x89,5x38 mm (plug not included)
Electrical consumption	< 3 W

SMART SCENES

Shelly GAS can be placed almost anywhere - in the kitchen, in your bathroom, etc. Just put the device anywhere you think there is even a slight chance for gas leakage, and create your scenes for when gas is detected - windows can be opened, doors unlocked, or lights turned on.



Shelly® DUO



COLOR TEMPERATURE GUIDE

2700K



3500K



4500K



6000K

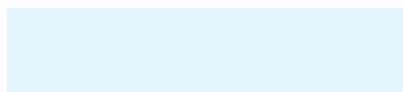

6500K

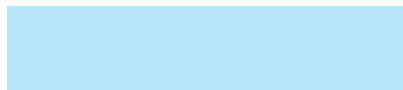

Wi-Fi Connected

No HUB required – Connect Shelly Bulb directly to your Wi-Fi at home and dim it.



Energy Efficient

Reduce energy usage without brightness or quality loss.



Easy Control

The only thing you need to manage all your Shelly Bulbs is a mobile phone and the free Shelly Cloud application.



Dimmable light

Enjoy dimmable light by fine-tuning your brightness.



Set Schedules

Shelly Bulb can wake you up and help you energize, read, concentrate and relax.



Highly Compatible

Compatible with Android, iOS, Amazon Alexa and Google Assistant.



Follow the Sunlight

Shelly Bulb can automatically turn on/off based on the sunrise and sunset hours.

SMART DIMMABLE BULB

Shelly Duo - Wi-Fi on board, Cloud and MQTT enabled, dimmable, voice control, smart Wake-up and Night mode. Automatically follow the sun and control your light accordingly. You can set your Shelly Duo bulbs directly from your phone and have them turn on/off based on the sunrise and sunset hours. Set Wake-up or Night mode with soft, dimmed light and the right color temperature.

TECHNICAL SPECIFICATIONS

	Shelly DUO	Shelly DUO GU10
Power supply	110-230V, 50/60Hz AC	
Socket	E27	GU10
Power Rating	9W	5W
Brightness	Warm White: 475 lm	Warm White: 475 lm
Color Temperature	2700K - 6500K	2700K - 6500K
Working temperature	-10°C ÷ 40°C	-10°C ÷ 40°C
Beam Angle	270°	36°
Complies with EU standards	<ul style="list-style-type: none"> • RE Directive 2014/53/EU • LVD 2014/35/EU • EMC 2014/30/EU • RoHS2 2011/65/EU 	
Radio signal power	1mW	
Radio protocol	WiFi 802.11 b/g/n	
Frequency	2412 - 2472 MHz	
Operational range (depending on local construction)	<ul style="list-style-type: none"> • up to 15 m outdoors • up to 8 m indoors 	
Dimensions	60x122 mm	50x73 mm
Electrical consumption	< 1 W	
SAR	1.10 W/Kg	



Shelly DUO RGBW



16 MILLION COLORS



Wi-Fi operated

Connect Shelly Bulb to your Wi-Fi at home.



Energy efficient

Reduce energy usage without brightness or quality loss.



16 million colors

Set the mood by choosing between 16 million colors.



Light temperature control

Easily set the desired light temperature.



Control remotely

Turn Shelly Bulb RGBW ON/OFF directly from your smartphone or tablet, and manage them easily no matter where you are.



Weekly Schedules

Easily create custom daily schedules and smart timers.



Sunrise/Sunset

Set Shelly Bulb RGBW to automatically turn ON/OFF based on sunrise and sunset hours.



No hub required

Control directly and without a hub through your smartphone with Shelly Cloud App.



Highly compatible

Use with your preferred home automation platforms and voice assistants.

WARM AND COLD LIGHT



SMART RGBW BULB WITH 16 MILLION COLORS

Shelly Bulb RGBW allows customers to control and adjust the brightness and the color of their light, choosing between 16 million colors. Shelly Bulb RGBW connects directly to the Wi-Fi at home and allows setting custom schedules, smart scenarios and Sunrise/Sunset actions.

TECHNICAL SPECIFICATIONS

	Shelly DUO	Shelly DUO GU10
Power supply	110-230V, 50/60Hz AC	
Socket	E27	GU10
Power Rating	9W	5W
Brightness	Warm White: 475 lm	Warm White: 475 lm
Color Temperature	3000K - 6500K	3000K - 6500K
Working temperature	-10°C ÷ 40°C	-10°C ÷ 40°C
Beam Angle	270°	36°
Complies with EU standards	<ul style="list-style-type: none">• RE Directive 2014/53/EU• LVD 2014/35/EU• EMC 2014/30/EU• RoHS2 2011/65/EU	
Radio signal power	1mW	
Radio protocol	WiFi 802.11 b/g/n	
Frequency	2412 - 2472 MHz	
Operational range (depending on local construction)	<ul style="list-style-type: none">• up to 15 m outdoors• up to 8 m indoors	
Dimensions	60x122 mm	50x73 mm
Electrical consumption	< 1 W	
SAR	1.10 W/Kg	



Shelly® Vintage



A60 MODEL



ST64 MODEL



G125 MODEL



Wi-Fi Connected

No HUB required – Connect Shelly Bulb directly to your Wi-Fi at home and choice of 16 million colors.



Energy Efficient

Reduce energy usage without brightness or quality loss.



Easy Control

The only thing you need to manage all your Shelly Bulbs is a mobile phone and the free Shelly Cloud application.



Dimmable light

Enjoy dimmable light by fine-tuning your brightness.



Set Schedules

Shelly Bulb can wake you up and help you energize, read, concentrate and relax.



Highly Compatible

Compatible with Android, iOS, Amazon Alexa and Google Assistant.



Follow the Sunlight

Shelly Bulb can automatically turn on/off based on the sunrise and sunset hours.

SMART DIMMABLE VINTAGE BULB

Shelly Vintage - Wi-Fi on board, Cloud and MQTT enabled, dimmable, voice control, smart Wake-up and Night mode. The smart vintage bulbs with spectacular design! Automatically follow the sun and set your light accordingly. You can control your Shelly Vintage bulbs directly from your phone and have them turn on/off based on the sunrise and sunset hours. Set Wake-up or Night mode with soft, dimmed light.

TECHNICAL SPECIFICATIONS

Type	A60	ST64	G126
Power supply	7W		4W
Socket	E27		
Power Rating	PF > 0.5		
Brightness	750lm	260lm	
Color Temperature	2700K		
Working temperature	-10°C ÷ +40°C		
Beam Angle	360°		
Complies with EU standards	<ul style="list-style-type: none"> • RE Directive 2014/53/EU • LVD 2014/35/EU • EMC 2014/30/EU • RoHS2 2011/65/EU 		
Radio signal power	1mW		
Radio protocol	WiFi 802.11 b/g/n		
Frequency	2412 - 2472 MHz		
Operational range (depending on local construction)	up to 15m outdoors up to 8m indoors		
Dimensions	60x115mm	64x160mm	125x155mm
Electrical consumption	< 1 W		
SAR	1.10 W/Kg		



QUICK AND EASY SET UP:

1. Screw in your Shelly Vintage Bulb in the light socket.
2. Download the Shelly Cloud application on your smartphone or tablet.
3. Connect Shelly Vintage bulb to your Wi-Fi router
4. Add Shelly Vintage bulb to Shelly Cloud and browse through the many possible settings.



SUPREME HOME AND FACILITY AUTOMATION WITH SHELLY'S PROFESSIONAL LINE OF DIN-RAIL SMART SWITCHES

Enhanced with temperature, overpower, and overvoltage load protection, Shelly Pro series is designed to be installed inside the breaker box (DIN). Allowing full smart automation with no additional cables or wiring, Shelly Pro line is perfect for homes, offices, stores, business, and manufacturing facilities, as well as new buildings.



CAPABILITIES



CONNECTIVITY



Wi-Fi



Bluetooth



LAN

ENHANCED SAFETY



Temperature protection



Overpower protection (PM devices)



Flame Retardant (V+0)



Overvoltage protection (PM devices)

FEATURES



HTTP/HTTPS webhooks



Sunrise/Sunset actions with offsets



Weekly Scheduling



Custom scripts(mJs)



Grouping



Scenes

Shelly ^{PRO}

AUTOMATION STRAIGHT FROM THE BREAKER BOX

Shelly Pro line allows full automation from the breaker box with minimized additional cables or wiring required. That makes it the perfect solution for new buildings and manufacturing facilities, which you can automate based on your or your business's needs.



PRECISE POWER MEASUREMENT

The PM devices of Shelly Pro line are equipped with ESP32 processor, providing immediate notifications and real-time power consumption measurements.

ENHANCED WITH



HTTP/HTTPS webhooks
Get notifications or control another compatible equipment or 3rd party automation system.



Scripting for custom automation
Get enhanced functionalities and additional processes settings for a specific integration or function.



Weekly scheduling automation
Quickly set actions based on your daily or weekly schedule.



Smart actions for dynamic control
Set Shelly Pro devices to switch on/off the power, based on the Sunset/Sunrise hour and enjoy dynamic control.

Shelly ^{PRO} 1



USE SHELLY PRO 1 for

Shelly Pro 1 is enhanced with scripting functionalities, allowing users to set custom automation scenes based on various occurrences such as weather forecast, wind force forecast, etc.



Lights control



Bathroom fan control



Irrigation system



Pool pump control



LAN, Wi-Fi and Bluetooth

Simultaneous Wi-Fi and LAN usage, add device fast and easy via Bluetooth connection



1 channel relay

1 output, 16A



Dry Contacts

Supports a wide range of voltages, with dry contacts



Wide range of voltage support

Shelly Pro 1 can be powered by 110-240VAC and 12VDC



Extremely fast processor

For immediate command execution and notification.



Wide variety of appliances control

Suitable for automating the lights, appliances, irrigation system, pool system, heaters, and many more.



Enhanced safety

Flame retardant shell (V-0) with internal overtemperature, over-power and overvoltage protection.



Enhanced security

MQTT and WSS support, TLS and custom certificates support for a broad range of use cases.



No hub required

Control directly and without a hub through your smartphone with Shelly Cloud App.



Highly compatible

Use with your preferred home automation platforms and voice assistants.

PROFESSIONAL LIGHTS AND APPLIANCES AUTOMATION FOR RESIDENTIAL OR COMMERCIAL USE

Shelly Pro 1 is a one-phase, 1 channel relay supporting up to 16A. Equipped with potential-free outputs (dry contacts), both Shelly Pro 1 offers high flexibility in voltage support and applications. Power it with 110-220V AC or 12V DC, use scripting functionalities to set custom automation scenes based on various occurrences.

TECHNICAL SPECIFICATIONS

Power supply	<ul style="list-style-type: none"> • 110-240 V AC, 50/60 Hz; • 12V DC $\pm 10\%$
Max load per channel	16A
Total max. current of all outputs	16A
Complies with EU standards:	<ul style="list-style-type: none"> • RE Directive 2014/53/EU • LVD 2014/35/EU • EMC 2014/30/EU • RoHS2 2011/65/EU
Working temperature	-20°C ÷ 40°C
Radio signal power	1mW
Wireless/WiFi Protocol	802.11 b/g/n (2.4 GHz)
Frequency:	2412 - 2472 MHz
Operational range (depending on local construction)	<ul style="list-style-type: none"> • up to 50 m outdoors • up to 30 m indoors
Dimensions (HxWxD)	94x19x69 mm
Electrical consumption	< 3 W
Wire cross section range	0.5 ÷ 1.5 mm ² (blue) 0.5 ÷ 2.5 mm ² (green)



HOW TO CONNECT

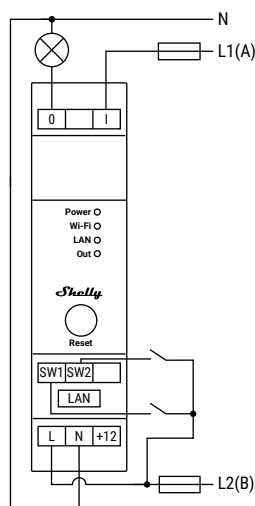

AC power supply – AC circuit switching

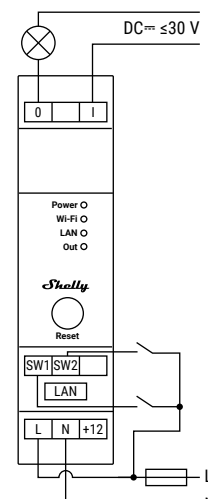

AC power supply – DC circuit switching

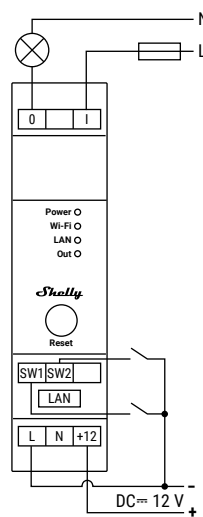

12 V DC power supply – AC circuit switching

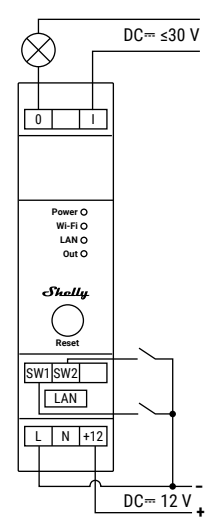

12 V DC power supply – DC circuit switching

LEGEND:

Device terminals:

- N:** Neutral terminal
- L:** Live (110-240V) terminal
- +12:** 12V (10.5V to 13.5V) DC power supply terminal
- SW1:** Switch (controlling 0*) input terminal
- SW2:** Switch* input terminal
- O:** Load circuit output terminal
- I:** Load circuit input terminal
- LAN:** Local Area Network RJ 45 connector

Wires:

- L:** Live (110-240V) wire
- N:** Neutral wire
- L1(A):** Load circuit live (110-240V) wire
- L2(B):** Device power supply live (110-240V) wire
- +**: 12 V DC power supply positive wire
- : 12 V DC power supply negative wire
- * Can be reconfigured*

Shelly ^{PRO} 1PM



USE SHELLY PRO 1PM for

Shelly Pro 1PM allows customers to automate, measure the power consumption, and analyze data from lights and appliances. Different types of actions, scenarios and schedules can be set to sync your environment to your daily activities or business needs.



Lights control



Laundry machine control



Water heater automation

Floor heating automation



LAN, Wi-Fi and Bluetooth

Simultaneous Wi-Fi and LAN usage, add device fast and easy via Bluetooth connection.



1 channel relay

1 output, 16A.



Wide range of voltage support

Shelly Pro 1PM can be powered by 110-240VAC and 12VDC.



Power metering with data storage

Integrated precise power meter that allow you to measure the consumption of the lights or appliances.



Wide variety of appliances control

Suitable for automating & measuring the consumption of lights, dishwashers, washing machines, appliances, etc.



Enhanced safety

Flame retardant shell (V-0) with internal overtemperature, over-power and overvoltage protection.



Enhanced security

MQTT and WSS support, TLS and custom certificates support for a broad range of use cases.



No hub required

Control directly and without a hub through your smartphone with Shelly Cloud App.



Highly compatible

Use with your preferred home automation platforms and voice assistants.

ENHANCED ELECTRICAL APPLIANCES AUTOMATION WITH PRECISE POWER METERING

Shelly Pro 1PM is a one-phase, 1 channel relay supporting up to 16A. Equipped with integrated power meter, it allows users to measure the precise power consumption of all automated lights or appliances. Shelly Pro 1PM is suitable for automating & measuring the consumption of lights, dishwashers, washing machines, appliances, etc. Power it with 110-240VAC or 12VDC, use scripting functionalities to set custom automation scenes based on various occurrences.

TECHNICAL SPECIFICATIONS

Power supply	<ul style="list-style-type: none"> • 110-240V; 50/60Hz AC/ • 12V DC $\pm 10\%$
Max load per channel	16A
Total max. current of all outputs	16A
Complies with EU standards:	<ul style="list-style-type: none"> • RE Directive 2014/53/EU • LVD 2014/35/EU • EMC 2014/30/EU • RoHS2 2011/65/EU
Working temperature	$-20^{\circ}\text{C} \div 40^{\circ}\text{C}$
Radio signal power	1mW
Wireless/WiFi Protocol	802.11 b/g/n (2.4 GHz)
Frequency:	2412 - 2472 MHz
Operational range (depending on local construction)	<ul style="list-style-type: none"> • up to 50 m outdoors • up to 30 m indoors
Dimensions (HxWxD)	94x19x69 mm
Electrical consumption	< 3 W
Wire cross section range	0.5 \div 1.5 mm ² (blue) 0.5 \div 2.5 mm ² (green)



HOW TO CONNECT

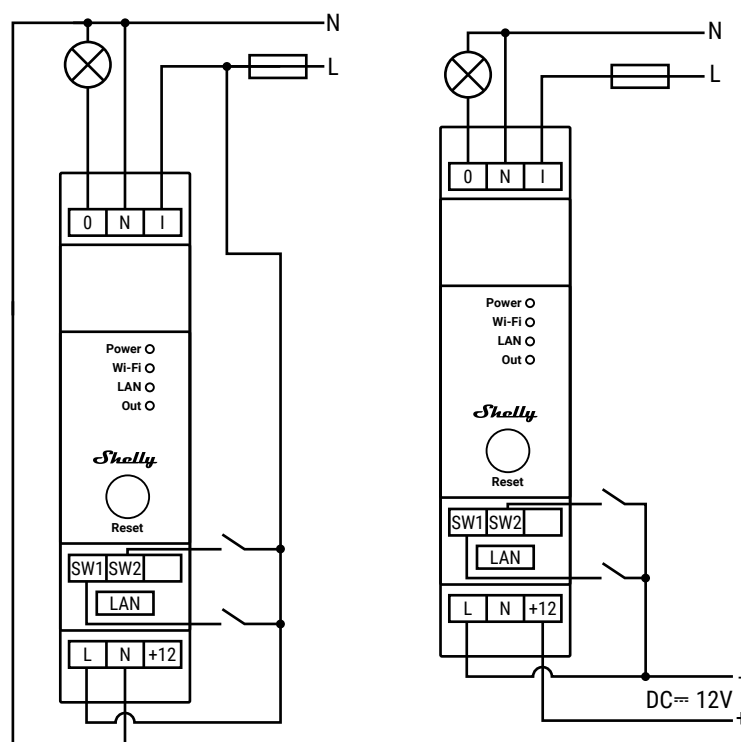

AC power supply – AC circuit switching

AC power supply – DC circuit switching

LEGEND:

Device terminals:

- O:** Load circuit output terminal
- I:** Load circuit input terminal
- SW1:** Switch (controlling O1*) input terminal
- SW2:** Switch* input terminal
- L:** Live (110-240V) terminal
- N:** Neutral terminals
- +12:** 12V (10.5V to 13.5V) DC power supply terminal
- LAN:** Local Area Network RJ 45 connector

Wires:

- N:** Neutral wire
- L:** Live (110-240V) wire
- +**: 12 V DC power supply positive wire
- : 12 V DC power supply negative wire
- * Can be reconfigured*

Shelly ^{PRO} 2



USE SHELLY PRO 2 FOR

Shelly Pro 2 are enhanced with scripting functionalities, allowing users to set custom automation scenes based on various occurrences such as weather forecast, wind force forecast, etc.

ACCESS CONTROL

Shelly Pro 2 are the perfect automation solution for garage doors and access barriers working on 12V DC. with dry contacts it supports a large variety of voltages. It is suitable for your home, warehouse or office.



LAN, Wi-Fi and Bluetooth

Simultaneous Wi-Fi and LAN usage, add device fast and easy via Bluetooth connection



2 channels relay

2 outputs, 16A each. Total device maximum capacity 25A.



Dry Contacts

Supports a wide range of voltages, with dry contacts.



Wide range of voltage support

Shelly Pro 2 can be powered by 110-240VAC and 12VDC



Extremely fast processor

For immediate command execution and notification.



Wide variety of appliances control

Suitable for automating the lights on 2 phases, appliances, pool and heating system, and many more.



Enhanced safety

Flame retardant shell (V-0) with internal overtemperature, over-power and overvoltage protection.



Enhanced security

MQTT and WSS support, TLS and custom certificates support for a broad range of use cases.



No hub required

Control directly and without a hub through your smartphone with Shelly Cloud App.



Highly compatible

Use with your preferred home automation platforms and voice assistants.

APPLIANCES AUTOMATION AND LIGHTS CONTROL ON 2 PHASES!

Shelly Pro 2 is two-phases and 2 channels relay, supporting up to 25A. Equipped with potential-free outputs (dry contacts), Shelly Pro 2 offers high flexibility in voltage support and applications. Power it with 110-220V AC or 12V DC, use scripting functionalities to set custom automation scenes based on various occurrences.

TECHNICAL SPECIFICATIONS

Power supply	<ul style="list-style-type: none"> • 110-240V; 50/60Hz AC • 12V DC $\pm 10\%$
Max load per channel	16A
Total max. current of all outputs	25A
Complies with EU standards:	<ul style="list-style-type: none"> • RE Directive 2014/53/EU • LVD 2014/35/EU • EMC 2014/30/EU • RoHS2 2011/65/EU
Working temperature	-20°C ÷ 40°C
Radio signal power	1mW
Wireless/WiFi Protocol	802.11 b/g/n (2.4 GHz)
Frequency:	2412 - 2472 MHz
Operational range (depending on local construction)	<ul style="list-style-type: none"> • up to 50 m outdoors • up to 30 m indoors
Dimensions (HxWxD)	94x19x69 mm
Electrical consumption	< 3 W
Wire cross section range	0.5 ÷ 1.5 mm ² (blue) 0.5 ÷ 2.5 mm ² (green)



HOW TO CONNECT

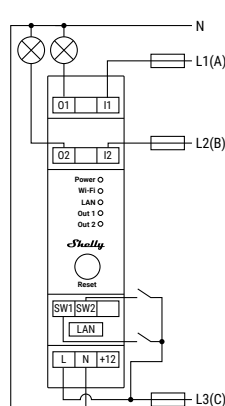

AC power supply – AC circuit switching

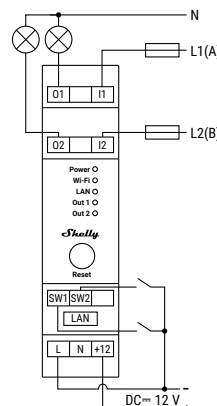

12 V DC power supply – AC circuits switching

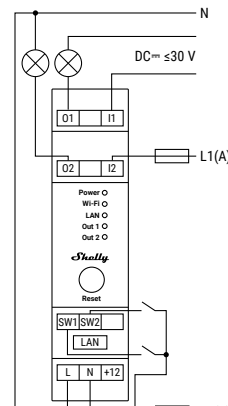

AC power supply – mixed AC & DC circuits switching

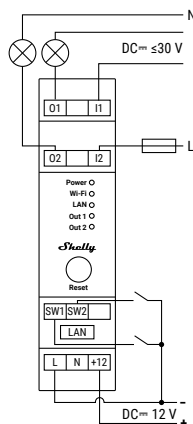

12 V DC – mixed AC & DC circuits switching

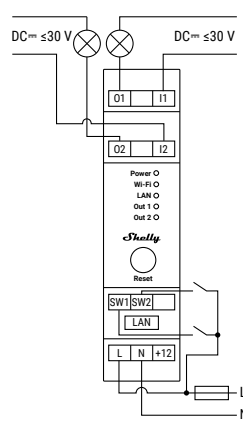

AC power supply – DC circuits switching

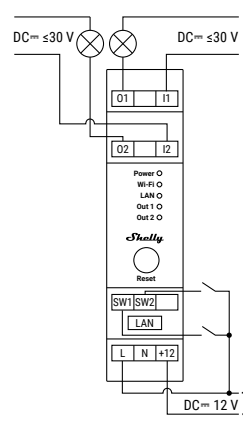

12 V DC power supply – DC circuits switching

LEGEND:

Device terminals:

- O1:** Load circuit 1 output terminal
- O2:** Load circuit 2 output terminal
- I1:** Load circuit 1 input terminal
- I2:** Load circuit 2 input terminal
- SW1:** Switch (controlling O1*) input terminal
- SW2:** Switch (controlling O2*) input terminal
- L:** Live (110-240V) terminal
- N:** Neutral terminal
- +12:** 12V (10.5V to 13.5V) DC power supply terminal
- LAN:** Local Area Network RJ 45 connector

Wires:

- N:** Neutral wire
- L:** Live (110-240V) wire
- L1(A):** Load circuit 1 live (110-240V) wire
- L2(B):** Load circuit 2 live (110-240V) wire
- L3(C):** Device power supply live (110-240V) wire
- +:** 12 V DC power supply positive wire
- :** 12 V DC power supply negative wire
- * Can be reconfigured*

Shelly ^{PRO} 2PM



USE SHELLY PRO 2PM FOR

Shelly Pro 2PM supports two-directional motor control, which makes it perfect for automation of roller shutters, curtains, awnings, and gates.

Customers can use scripting functionalities to set custom automation scenes based on various occurrences, weather forecast, wind forecast, etc.



Roller shutter automation

Curtains automation



Sliding doors control

Pool cover automation



Office blinds

Gate automation



LAN, Wi-Fi and Bluetooth

Simultaneous Wi-Fi and LAN usage, add device fast and easy via Bluetooth connection



2 channels relay

2 outputs 16A each, total device maximum capacity of 25A.



Wide range of voltage support

Shelly Pro 2PM can be powered by 110-240V AC and 12V DC.



Power metering with data storage

Two integrated precise power meters that allow you to measure the consumption for each channel separately



Two-directional control

Control any 110-230V bi-directional motor, roller shutters, motorized curtains, or awning



Wide variety of appliances control

Suitable for appliances, roller shutters, awnings, motors up to 600W, lights on different phases, and many more.



Enhanced safety

Flame retardant shell (V-0) with internal overtemperature, over-power and overvoltage protection.



Enhanced security

MQTT and WSS support, TLS and custom certificates support for a broad range of use cases.



No hub required

Control directly and without a hub through your smartphone with Shelly Cloud App.



Highly compatible

Use with your preferred home automation platforms and voice assistants.

BLINDERS AND ROLLER SHUTTERS AUTOMATION AND CONTROL WITH PRECISE POWER METERING

Shelly Pro 2PM is a 2 channel relay, supporting up to 16A per phase with total device capacity of 25A. Equipped with two integrated precise power meters that allow customers to measure the consumption for each channel separately. Shelly Pro 2PM is suitable for appliances, roller shutters, awnings, motors up to 600W. Power it with 110-240VAC or 12VDC, use scripting functionalities to set custom automation scenes based on various occurrences.

TECHNICAL SPECIFICATIONS

Power supply	<ul style="list-style-type: none"> • 110-240V; 50/60Hz AC • 12V DC $\pm 10\%$
Max load per channel	16A
Total max. current of all outputs	25A
Complies with EU standards:	<ul style="list-style-type: none"> • RE Directive 2014/53/EU • LVD 2014/35/EU • EMC 2014/30/EU • RoHS2 2011/65/EU
Working temperature	$-20^{\circ}\text{C} \div 40^{\circ}\text{C}$
Radio signal power	1mW
Wireless/WiFi Protocol	802.11 b/g/n (2.4 GHz)
Frequency:	2412 - 2472 MHz
Operational range (depending on local construction)	<ul style="list-style-type: none"> • up to 50 m outdoors • up to 30 m indoors
Dimensions (HxWxD)	94x19x69 mm
Electrical consumption	< 3 W
Wire cross section range	0.5 \div 1.5 mm ² (blue) 0.5 \div 2.5 mm ² (green)



HOW TO CONNECT

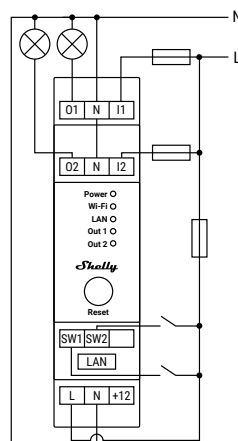

AC power supply – AC circuit switching

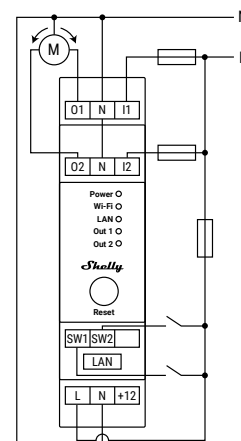

AC power supply – AC bi-directional motor

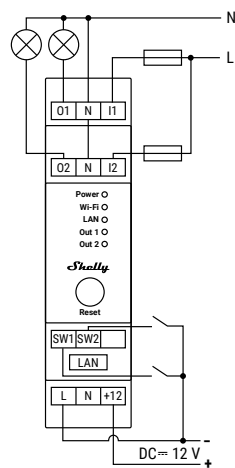

12 V DC power supply – AC circuits switching

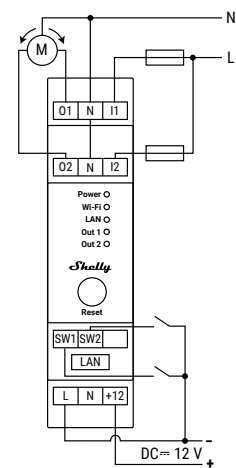

12 V DC power supply – AC bi-directional motor

LEGEND:

Device terminals:

- O1:** Load circuit 1 output terminal
- O2:** Load circuit 2 output terminal
- I1:** Load circuit 1 input terminal
- I2:** Load circuit 2 input terminal
- SW1:** Switch (controlling O1*) input terminal
- SW2:** Switch (controlling O2*) input terminal
- L:** Live (110-240V) terminal

N: Neutral terminals

+12: 12V (10.5V to 13.5V) DC power supply terminal

LAN: Local Area Network RJ 45 connector

Wires:

- N:** Neutral wire
- L:** Live (110-240V) wire
- +**: 12 V DC power supply positive wire
- : 12 V DC power supply negative wire
- * Can be reconfigured*

Shelly ^{PRO} 4PM



USE SHELLY PRO 4PM FOR

With the power to control and power measure a variety of appliances, Shelly Pro 4PM can work standalone or be complementary to any existing automation project in your home or office.



Office lights

Ventilation control



Office outlets

Heating system



AC motor pumps control

Load shedding control



LAN connection

Enhanced with LAN connection for even more stable connection.



Wi-Fi operated

Connect Shelly Pro 4PM to your Wi-Fi network.



Bluetooth connectivity

Add devices quickly and easily via Bluetooth connection, using Shelly Cloud App.

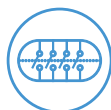

4 channels

4 outputs, 16A each, total device maximum of 40A.



Screen with navigation keys

1.8-inch color screen for quick relay control and settings update.



Power metering with data storage

Four integrated precise power meters that allow you to measure the consumption for each channel separately.



Wide variety of appliances control

Suitable for controlling and measuring the consumption of lights, appliances, pool system, heaters, and many more.



Enhanced safety

Flame retardant shell (V-0) with internal overtemperature, over-power and overvoltage protection.



Enhanced security

MQTT and WSS support, TLS certificate support and management for a broad range of use cases.



No hub required

Control directly without a hub through your smartphone with Shelly Cloud App.



Highly compatible

Use with your preferred home automation platforms and voice assistants.

SUPREME HOME AND FACILITY AUTOMATION STRAIGHT FROM THE BREAKER BOX

4-channel DIN-mountable smart relay with Wi-Fi, Bluetooth and LAN connectivity. **Shelly Pro 4PM** is enhanced with temperature, overpower, and overvoltage load protection. It allows full automation for residential, commercial, and other applications.

TECHNICAL SPECIFICATIONS

Power supply	• 110-240V, 50/60Hz AC
Max load per channel	16A
Total max. current of all outputs	40A
Complies with EU standards:	<ul style="list-style-type: none"> • RE Directive 2014/53/EU • LVD 2014/35/EU • EMC 2014/30/EU • RoHS2 2011/65/EU
Working temperature	0°C ÷ 40°C
Radio signal power	1mW
Wireless/WiFi Protocol	802.11 b/g/n (2.4 GHz)
Frequency:	2412 - 2472 MHz
Operational range (depending on local construction)	<ul style="list-style-type: none"> • up to 50 m outdoors • up to 30 m indoors
Dimensions (HxWxD)	95x53x58 mm
Electrical consumption	< 4 W

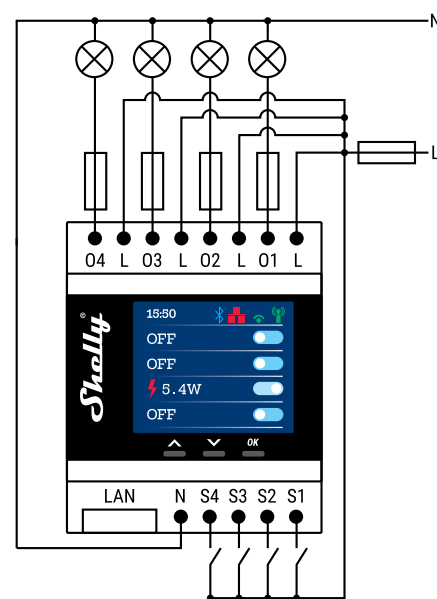

LEGEND:

N - Neutral input (Zero);
L - Line input (110-240V);
L* - Input of O1, O2, O3, O4;
O1, O2, O3, O4 - Output 1, 2, 3, 4;
S - Switch (input) for control;
S1, S2, S3, S4 - Switch (input) controlling O1, O2, O3, O4
LAN - Local Area Network RJ 45 connector
**The cables connected to L must be with the same length!*



ACCESSORIES FOR SHELLY PRODUCTS

With these accessories you can improve your experience with Shelly products.

Shelly Button

Safe way to use Shelly 1, Shelly 1PM and Shelly Dimmer out of the wall. You can make any table light, fan or heater smart.



Shelly H&T power supply

You can power your Shelly H&T with USB instead of battery.



Outdoor IP55 AddOn - UK



Split core current transformer

Used together with Shelly EM or Shelly 3EM for energy metering.



Shelly GAS addon manipulator



Temperature sensor add-on

Add-on for your Shelly 1 or Shelly 1PM.



Bypass



WALL SWITCH FOR SMART RELAYS

Designed to facilitate your specific automation needs and developed with the smallest details in mind, you can now create a custom wall switch for your Shelly relays, and save on space and money!

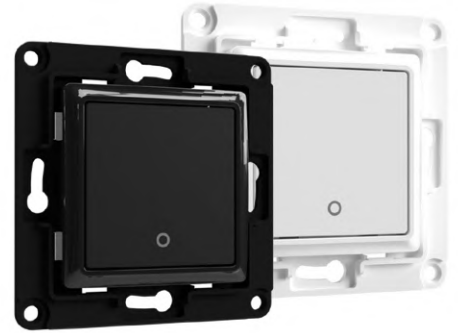

FITS INTO THE TINIEST SPACES!

Compact dimensions and simple wiring that can fit into any existing switch console or even the tiniest spaces.

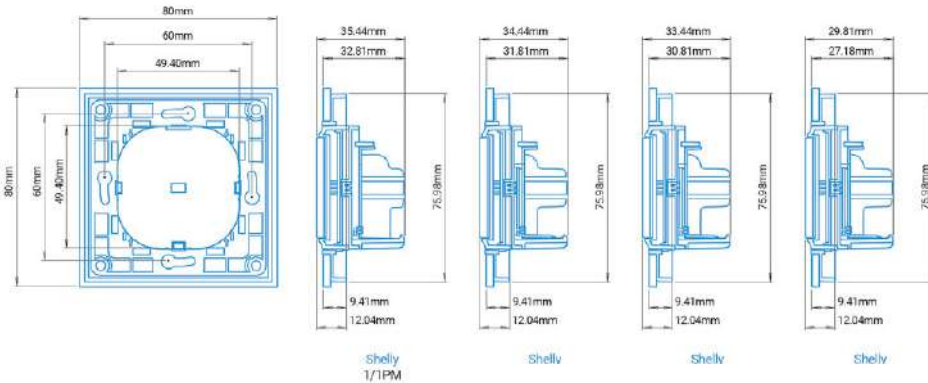

HIGHLY CUSTOMIZABLE!

Each Shelly Wall Switch for Smart Relays comes with corresponding relay holders. You can choose the relay holder that you need to fulfill your automation project.

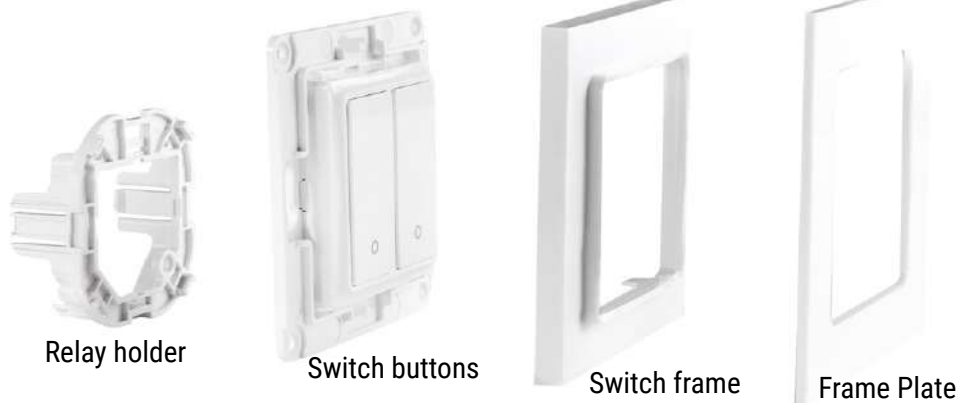

AVAILABLE SWITCHES*:

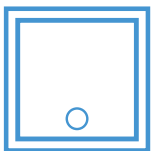

Plus series
1/1PM
1L/Dimmer2

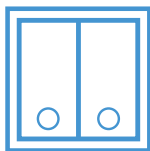

Plus series
2.5
1L/Dimmer2

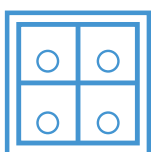

Plus i4

AVAILABLE FRAMES*:

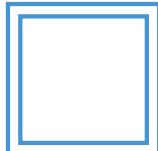

Single
frame

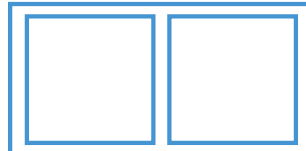

Double
frame

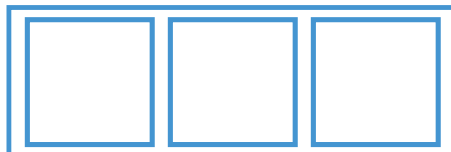

Triple frame

AVAILABLE COLORS:



White



Black

*Shelly Wall switches and Shelly Wall frames are sold separately!



ALLTERCO