

# Columns and mini-columns

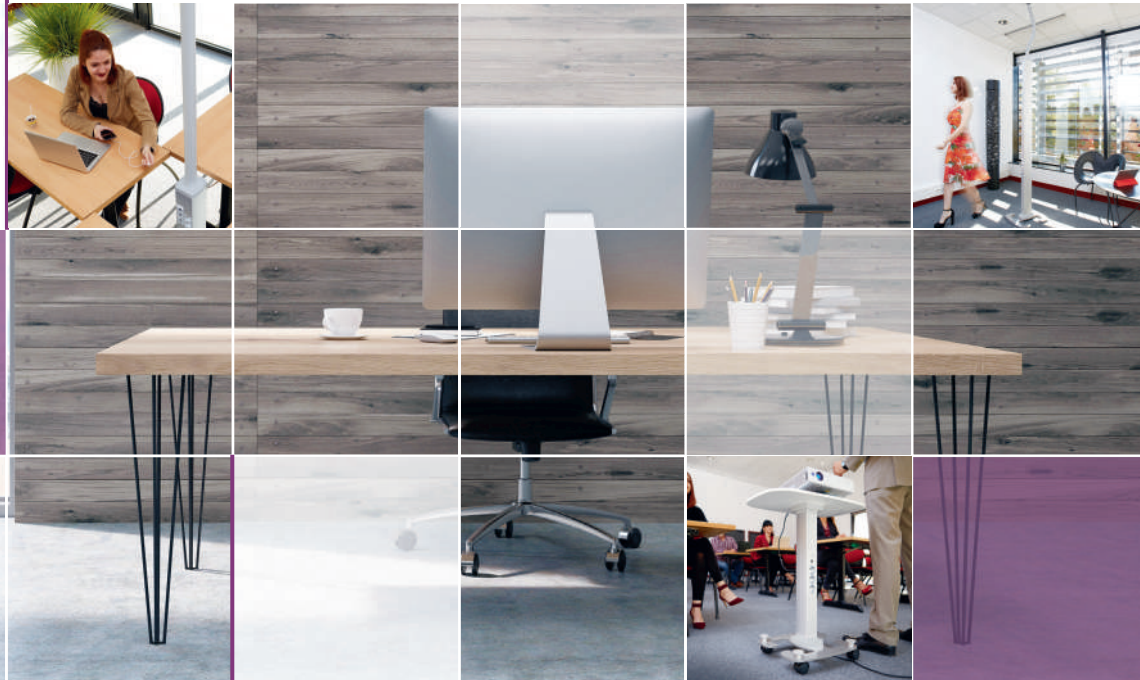

ATTRACTIVE, MULTIFUNCTIONAL  
AND EASY TO INSTALL

CATALOGUE  
PAGES  
→ INSIDE

# Real freedom of choice

An extensive range which covers every need in terms of connectivity, size, cabling capacity and finishes throughout the world for different types of site



## Types of **site**:



### **Commercial:**

- individual or open space offices
- meeting rooms, classrooms
- lobbies in hotels
- shopping centres, small shops



### **Infrastructures:**

- waiting rooms in airports or government offices

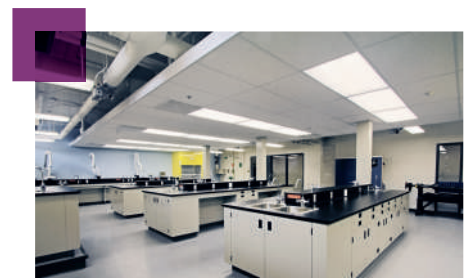

### **Industry:**

- laboratories

## A **snap-on** version

compatible with Arteur and Mosaic wiring accessories ranges

**2 sides**

**| Capacity:**

1 compartment  
2 compartments  
4 compartments

**| Mini-columns:**

Fixed version or  
movable version  
0.3 and 0.68 m

**| Columns:**

Fixed version or  
movable version  
2.67 and 3.90 m

**| In addition:**

The "Ovaline" column (without wiring accessories)  
Accessories such as TV stands, shelves, panel indicators



## A **"universal"** version

compatible with different wiring accessory ranges, French, British or German standard

**1 or 2 sides**

**| Capacity:**

1 compartment  
2 compartments

**| Mini-columns:**

Fixed version or 1 compartment  
movable version 0.3 and 0.68 m

**| Columns:**

Fixed version  
2.67 and 3.90 m

**| On top of the standard offer**

Option of requesting products preconfigured in terms of both size and finish.



# An attractive range



## Snap-on columns/mini-columns:

The column with 1 compartment/2 sides is one of the slimmest on the market, allowing wiring accessories to be integrated at the same time

Perfect integration of Mosaic and Arteor mechanisms in the column body



3 finishes available: white, aluminium and black, to match the wiring accessory colours

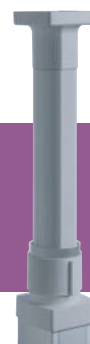
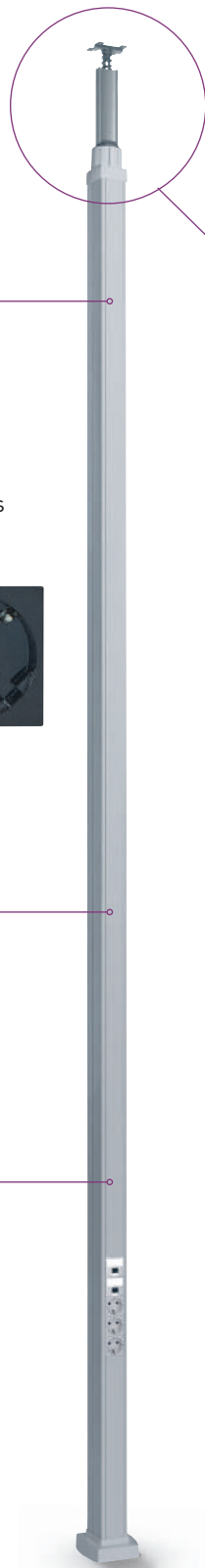

Finishing kit for columns creates an aesthetically-pleasing connection to the ceiling



The Ovaline kit provides an impeccable finish for mini-columns if the current incomer is via the ceiling



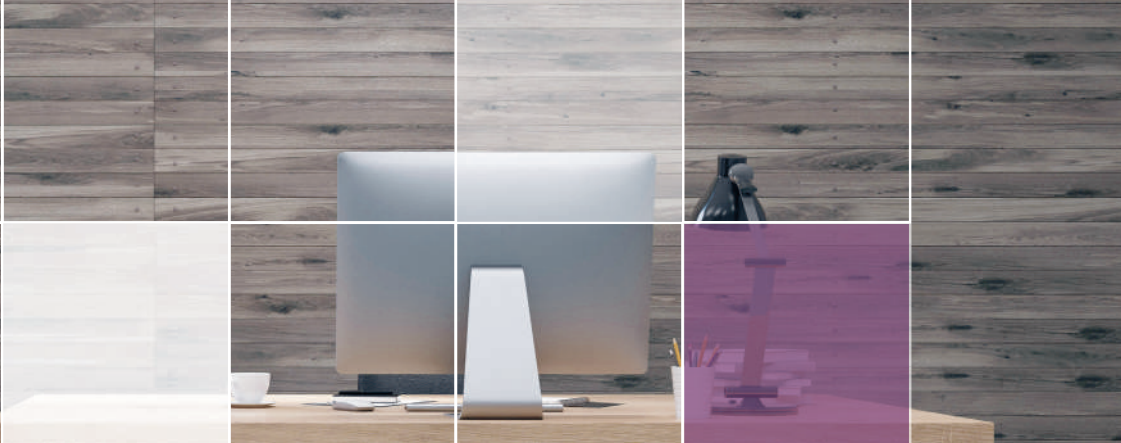

## Universal columns/mini-columns:

Perfect integration of different wiring accessory ranges in different standards thanks to dedicated grids



3 finishes available as standard: white, aluminium and black, to match the wiring accessory colours. Other colours available in preconfigured version

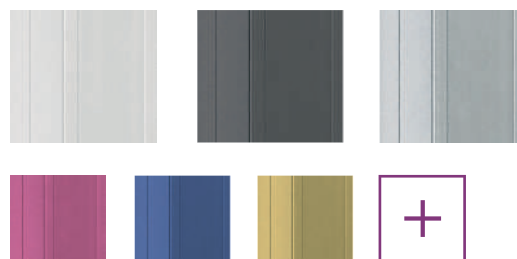

## Snap-on or universal columns/mini-columns:

Stylish and ingenious accessories: shelf, panel indicator, flat screen TV fixing supports



# Convenient to use and accessible

---



| Columns/mini-columns can be installed right next to users  
In addition, mini-columns are the perfect size for discreet integration under a desk or table



| The 4-compartment colum can be used to supply power or data current to up to 4 workstations  
It can take wiring accessories right up a maximum height of 68 cm



| Movable columns can easily adapt to changes in the work space configuration. The base is specially designed for maximum stability and its shape has been created to blend in perfectly with the office furniture feet



| The shelf which fits onto movable columns and mini-columns allows a point of support for writing or for the installation of a video projector

# Ease of installation



The innovative “turn & fix” compensating system locks the column position – The system is available for the whole range (except for 4-compartment columns)

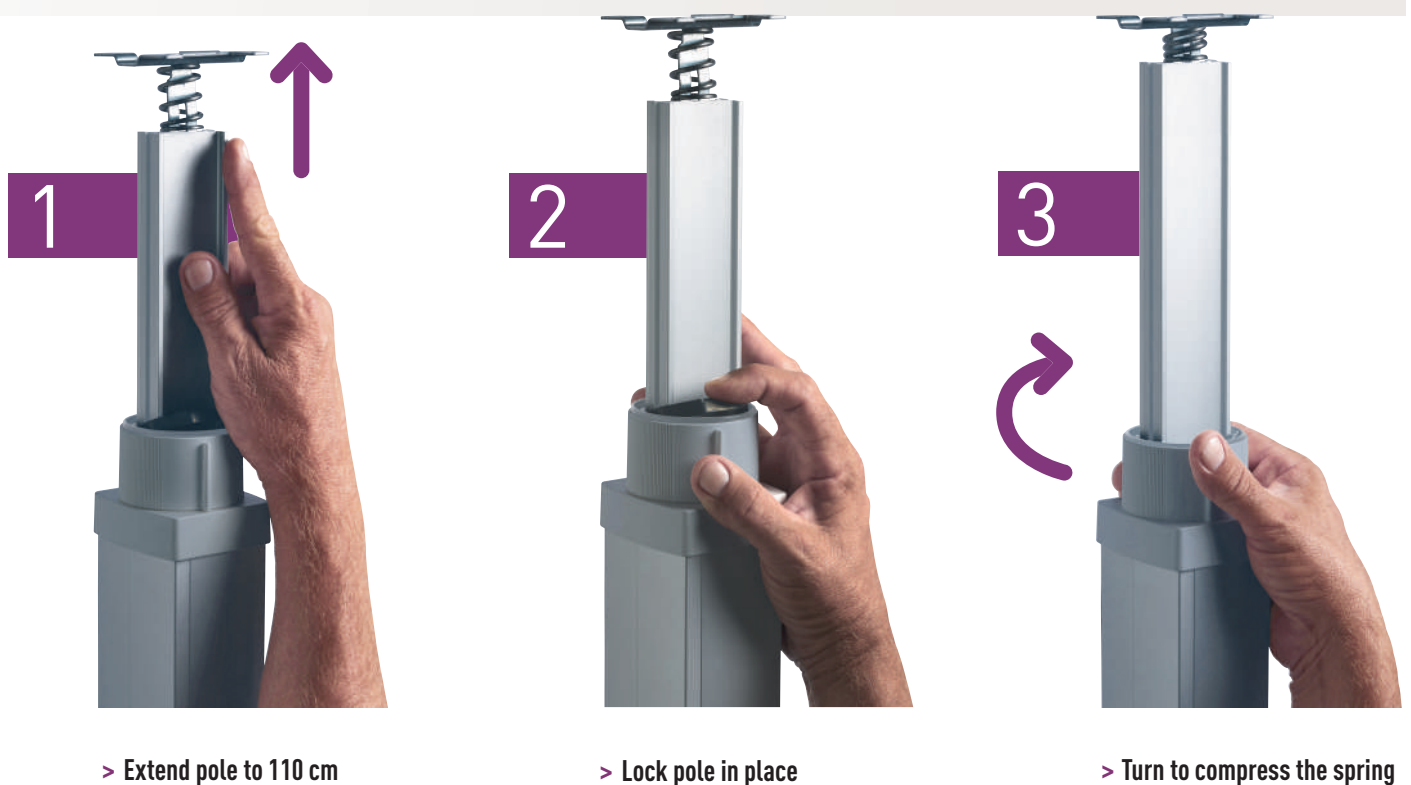

Flexible ovaline accessory is used horizontally for the 4-compartment column and the 1 or 2-compartment columns, equipped with the pole finishing kit, to make it easier to run cables between the column and the cable trays

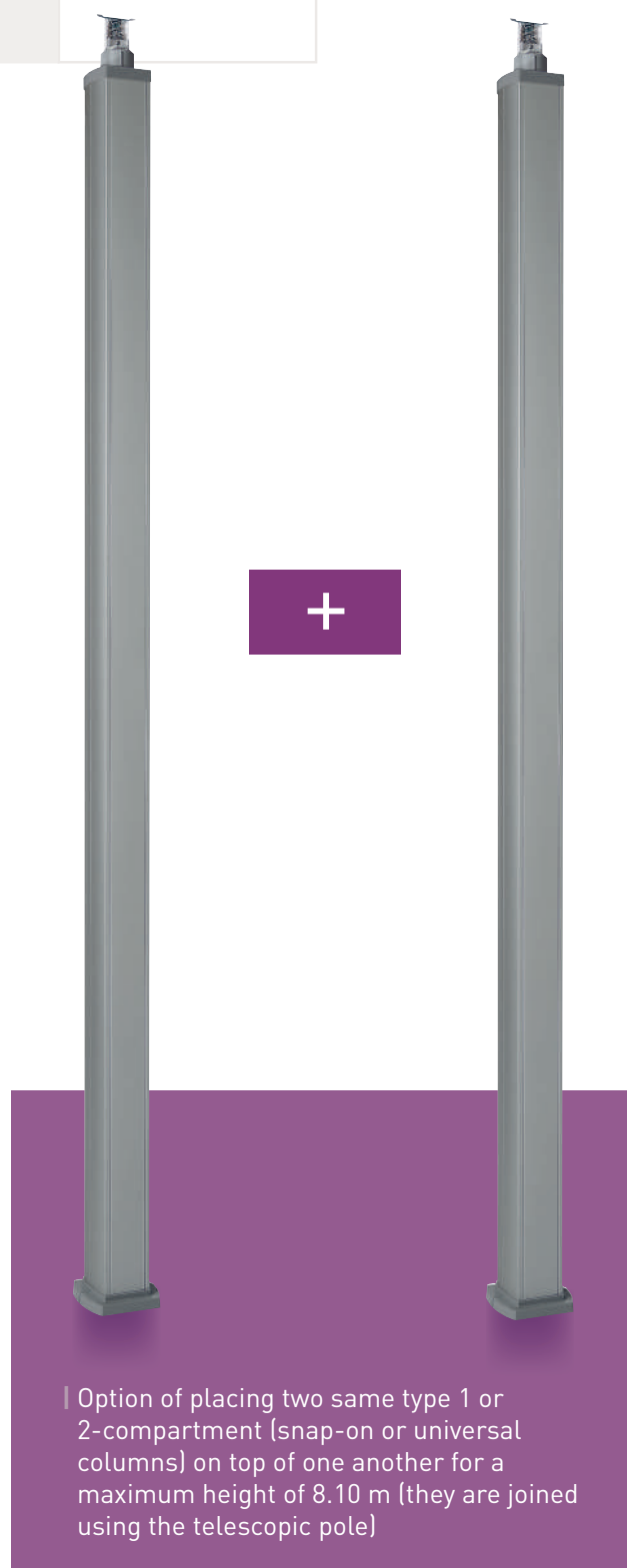
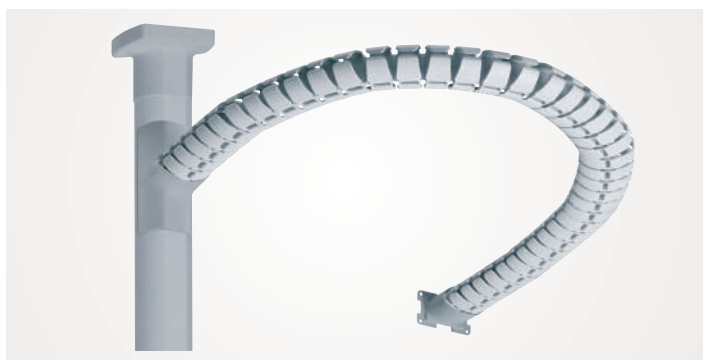

Option of placing two same type 1 or 2-compartment (snap-on or universal columns) on top of one another for a maximum height of 8.10 m (they are joined using the telescopic pole)

# Snap-on mini-columns

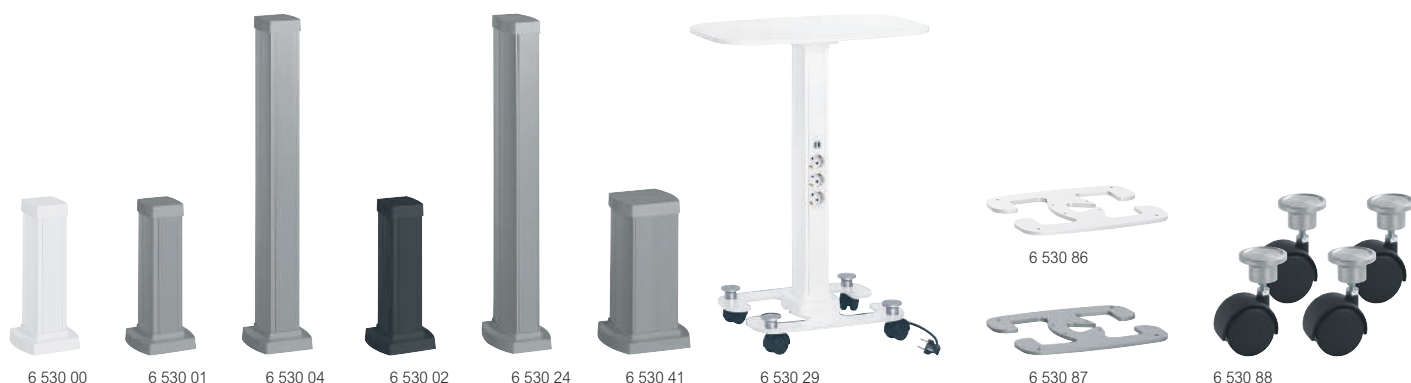

Technical characteristics **see p. 11 and e-catalogue**

Conform to IEC 61084-2-4 and EN 50085-2-4. For distribution of power vertically. Power supply via the floor or the ceiling (with ovaline kits)  
To be equipped with Arteor or Mosaic wiring accessories (direct clipping). Cover width 45 mm

### Pack Cat.Nos 1 compartment 2 sides mini-columns

		Can be equipped with ovaline kits Cat.Nos 6 530 60/61/62	
		<b>White finish</b> Aluminium body, PVC covers	
1	6 530 00	Height 0.30 m	
1	6 530 03	Height 0.68 m	
		<b>Aluminium finish</b> Aluminium body and covers	
1	6 530 01	Height 0.30 m	
1	6 530 04	Height 0.68 m	
		<b>Black finish</b> Aluminium body, PVC covers	
1	6 530 02	Height 0.30 m	
1	6 530 05	Height 0.68 m	

### 2 compartments mini-columns

		Can be equipped with ovaline kits Cat.Nos 6 530 63/64/65	
		<b>White finish</b> PVC body and covers	
1	6 530 20	Height 0.30 m	
1	6 530 23	Height 0.68 m	
		<b>Aluminium finish</b> Aluminium body and covers	
1	6 530 21	Height 0.30 m	
1	6 530 24	Height 0.68 m	
		<b>Black finish</b> Aluminium body, PVC covers	
1	6 530 22	Height 0.30 m	
1	6 530 25	Height 0.68 m	

### 4 compartments mini-columns

		<b>White finish</b> Aluminium body, PVC covers	
1	6 530 40	Height 0.30 m	
1	6 530 43	Height 0.68 m	
		<b>Aluminium finish</b> Aluminium body and covers	
1	6 530 41	Height 0.30 m	
1	6 530 44	Height 0.68 m	
		<b>Black finish</b> Aluminium body, PVC covers	
1	6 530 42	Height 0.30 m	
1	6 530 45	Height 0.68 m	

### Pack Cat.Nos Movable mini-column

1	6 530 29	Roll and plug column Aluminium body Table: white finish Equipped with: - 7 x 2P+E German standard socket outlets - 1 double USB charging socket, - 4-wheel foot, - 4 m cable Height 0.75 m
---	----------	--

### Ovaline kits

		For powering the mini-column via the ceiling
		<b>For 1 compartment 2 sides mini-columns</b>
1	6 530 60	White finish
1	6 530 61	Aluminium finish
1	6 530 62	Black finish
		<b>For 2 compartments snap-on mini-columns and 1 compartment universal columns</b>
1	6 530 63	White finish
1	6 530 64	Aluminium finish
1	6 530 65	Black finish

### Accessories for 1 or 2 compartments mini-columns

1	6 530 84	Table - white finish
1	6 530 86	Movable foot - white finish
1	6 530 87	Movable foot - aluminium finish
1	6 530 88	Set of 4 wheels with cable-holder

Multi-support sockets, **p. 12**





## Snap-on columns (continued)



Conform to IEC 61084-2-1 and EN 50085-2-4  
For distribution of power vertically  
Power supply via the ceiling and/or the floor  
Cover width 45 mm

Pack	Cat.Nos	Ovaline column
1	6 530 54	Aluminium finish Complete Ovaline column, height 3.2 m
1	6 530 55	Ovaline tube, height 3.2 m
1	6 530 58	Ovaline junction 90°
1	6 530 59	Ovaline fixing bracket
1	6 530 57	Cable output for Ovaline column
<b>Finishing kit for telescopic pole for 1 or 2 compartments columns</b>		
1	6 530 66	Consists of 2 PVC covers and a base White finish
1	6 530 67	Aluminium finish
1	6 530 68	Black finish
<b>Accessories for columns</b>		
1	6 530 56	Flexible Ovaline kit For horizontal connection to cable trays Length: 1 m Supplied with fixing bracket
36	6 038 07	Separation partition, height 60 mm For 2 and 4 compartments snap-on columns and mini-columns
1	6 530 80	Panel indicator 150 x 150 mm
1	6 530 81	Support for fixing TV screen 10-26 inch / 25-66 cm
1	6 530 82	Support for fixing TV screen 26-42 inch / 66-107 cm
1	6 530 83	Shelf for direct clipping
<b>Supports for rail equipment (columns and mini-columns)</b>		
For mounting rail equipment (such as MCBs) on columns and mini-columns. To be used with two 0.5-module spacing units Cat.No 4 063 07 Capacity: 1 module Equipped with protective cover to prevent unwanted triggering For installation on universal columns and mini-columns use a fixing support Cat.No 6 531 79, a 4-module Mosaic Programme support plate Cat.No 0 802 52 and a 4-module Mosaic Programme plate Cat.Nos 0 788 14, 0 793 14 or 0 790 54		
5	0 310 69	White finish
5	0 307 87	Aluminium finish
5	6 530 75	Black finish
<b>90° adaptor</b>		
5	6 530 79	Adaptor for mounting Arteor or Mosaic wiring accessories horizontally via 90° rotation 2 modules

## Multi-support sockets - German standard socket outlets, USB charging socket, HDMI type A socket



Particularly suitable for installation in snap-on columns and mini-columns, pop-up flush-mounting boxes for furniture and empty flush-mounting office modules

Pack	Cat.Nos	Multi-support German standard socket outlets - inclined 45°
10	Black 0 793 55	Automatic terminals 2 P+E
10	0 793 72	2 x 2P+E
10	0 793 73	3 x 2P+E
<b>RJ 45 data sockets</b>		
10	Black 0 794 81	<b>Cat 6 UTP</b> 1 module
10	0 794 85	<b>Cat 6 FTP</b> 2 modules
10	0 794 86	<b>Cat 6 STP</b> 2 modules
<b>Double USB charging socket</b>		
1	Black 0 793 84	5 V - 2.4 A - 2 modules For recharging portable devices like: telephones, smartphones, MP3/MP4 players and fast-charging tablet PC Conform to IEC 62684-2011-01 Consumption in passive mode < 0.07 W Supplied cordless
<b>HDMI type A socket</b>		
1	Black 0 793 68	Preterminated HDMI 1.4 - 1 module Equipped with cord, length 15 cm Used to transmit high-definition digital audio/video streams between a source (computer, Blu-ray player...) and a compatible receiver (TV, videoprojector...) Can be associated with HDMI cord & cable

# Snap-on mini-columns and columns

## ■ Dimensions (in mm)

1-compartment columns, mini-columns and movable columns

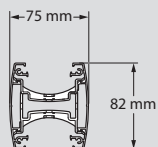

2-compartment columns, mini-columns and movable columns

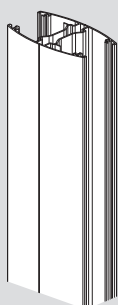
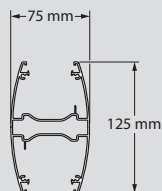

4-compartment columns and mini-columns

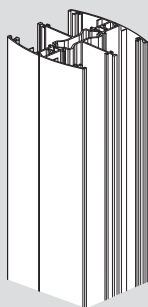
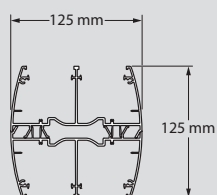

## ■ Wiring capacity

1-compartment columns

Max. capacity of conductors (for each type of conductor)	1-compartment (with entretoise)		1-compartment (with 1 mechanism)		1-compartment (with 1 mechanism and entretoise)		
	A	B	A	B	A	B	
Compartment	A	B	A	B	A	B	
Total cross-section (mm <sup>2</sup> )	1440	1440	3220	-	210	1440	
Number of cables	Ø7 mm	22	22	54	-	-	22
	Ø9 mm	12	12	30	-	-	12
	Ø11 mm	9	9	18	-	-	9

2-compartment and 4-compartment columns

Max. capacity of conductors (for each type of conductor)	2-compartment (with 1 mechanism)		4-compartment (with 1 mechanism)		
	A	B	A	B	
Compartment	A	B	A	B	
Total cross-section (mm <sup>2</sup> )	1470	3110	1110	2760	
Number of cables	Ø7 mm	20	54	15	48
	Ø9 mm	12	34	9	30
	Ø11 mm	9	22	6	20

Ovaline columns

Max. capacity of conductors (for each type of conductor)	Rigid Ovaline	Flexible Ovaline	Telescopic pole with covers	
Compartment	A	A	A	
Total cross-section (mm <sup>2</sup> )	1000	485	985	
Number of cables	Cat. 6 FTP or coaxial Ø7 mm	18	9	18
	3 x 1.5 mm Ø9 mm	10	5	10
	3 x 2.5 mm Ø11 mm	6	3	6

## ■ Installation principle of the Flexible Ovaline kit on snap-on column

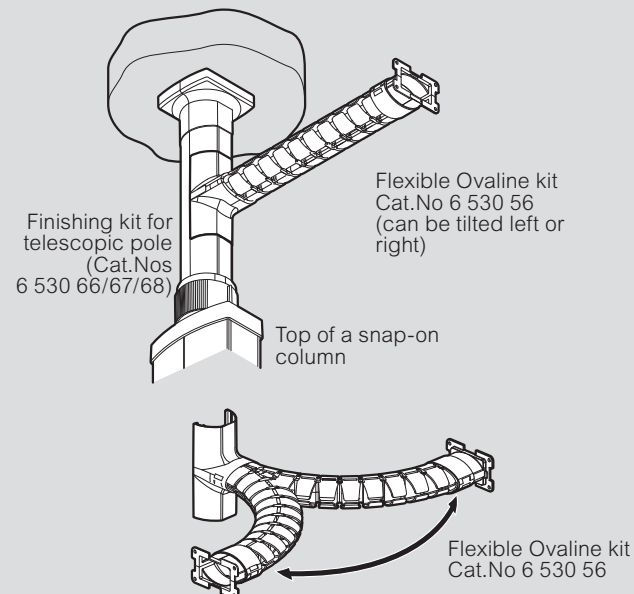

## Universal mini-columns

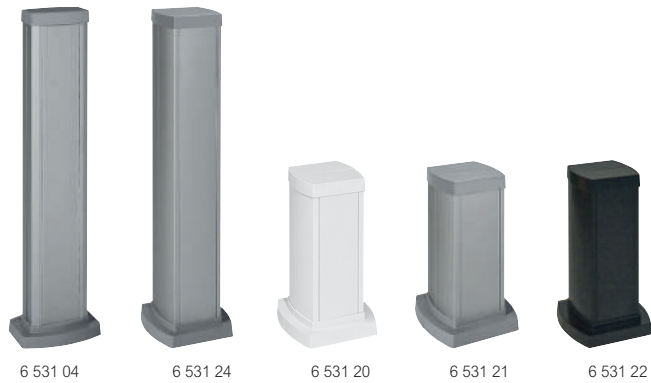

For distribution of power vertically (with the input in separate ducts for power and data cables)  
Power supply via the floor or the ceiling (with ovaline kits)  
To be equipped with supports for wiring accessories  
Cover width 80 mm

Pack	Cat.Nos	1 compartment
		Aluminium body and covers
1	6 531 00	<b>White finish</b> Height 0.30 m
1	6 531 03	Height 0.68 m
		<b>Aluminium finish</b>
1	6 531 01	Height 0.30 m
1	6 531 04	Height 0.68 m
		<b>Black finish</b>
1	6 531 02	Height 0.30 m
1	6 531 05	Height 0.68 m
		<b>2 compartments</b>
		Aluminium body and covers
1	6 531 20	<b>White finish</b> Height 0.30 m
1	6 531 23	Height 0.68 m
		<b>Aluminium finish</b>
1	6 531 21	Height 0.30 m
1	6 531 24	Height 0.68 m
		<b>Black finish</b>
1	6 531 22	Height 0.30 m
1	6 531 25	Height 0.68 m
		<b>Ovaline kits</b>
		For 1 compartment cover width 80 or 2 compartment cover width 45 mini-columns For powering the mini-column via the ceiling
1	6 530 63	White finish
1	6 530 64	Aluminium finish
1	6 530 65	Black finish
		<b>Accessories for 1 compartment mini-columns</b>
1	6 530 84	Table - white finish
1	6 530 85	Table with induction charger 1000 mA - white finish
1	6 530 86	Movable foot - white finish
1	6 530 87	Movable foot - aluminium finish
1	6 530 88	Set of 4 wheels with cable-holder

## Universal columns

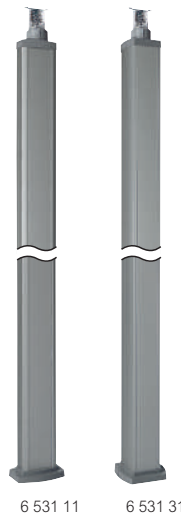

For distribution of power vertically (with the input in separate ducts for high voltage and low voltage cables)  
Power supply via the floor or the ceiling (with ovaline kits)  
To be equipped with supports for wiring accessories  
Cover width 80 mm

Pack	Cat.Nos	1 compartment
		Aluminium body and covers
1	6 531 10	<b>White finish</b> Height 2.67 m Can be adapted to a ceiling height up to 3.9 m
1	6 531 13	Height 3.9 m Can be adapted to a ceiling height up to 5.1 m
		<b>Aluminium finish</b>
1	6 531 11	Height 2.67 m Can be adapted to a ceiling height up to 3.9 m
1	6 531 14	Height 3.9 m Can be adapted to a ceiling height up to 5.1 m
		<b>Black finish</b>
1	6 531 12	Height 2.67 m Can be adapted to a ceiling height up to 3.9 m
1	6 531 15	Height 3.9 m Can be adapted to a ceiling height up to 5.1 m
		<b>2 compartments</b>
		Aluminium body and covers
1	6 531 30	<b>White finish</b> Height 2.67 m Can be adapted to a ceiling height up to 3.9 m
1	6 531 33	Height 3.9 m Can be adapted to a ceiling height up to 5.1 m
		<b>Aluminium finish</b>
1	6 531 31	Height 2.67 m Can be adapted to a ceiling height up to 3.9 m
1	6 531 34	Height 3.9 m Can be adapted to a ceiling height up to 5.1 m
		<b>Black finish</b>
1	6 531 32	Height 2.67 m Can be adapted to a ceiling height up to 3.9 m
1	6 531 35	Height 3.9 m Can be adapted to a ceiling height up to 5.1 m

## Accessories, boxes and supports for universal columns

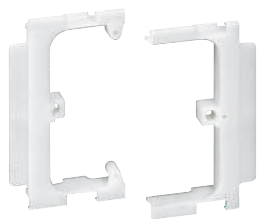

6 531 79

Pack	Cat.Nos	Accessories
1	6 531 69	Metal separation partition, length 1.1 m
1	6 531 80	Panel indicator 150 x 150 mm
1	6 531 81	Support for fixing TV screen 10-26 inch / 25-66 cm
1	6 531 82	Support for fixing TV screen 26-42 inch / 66-107 cm
1	6 531 83	Shelf, white finish

Pack	Cat.Nos	Boxes
1	5 102 01	1-gang mounting box
1	5 102 02	2-gang mounting box
1	5 102 03	Junction box

Pack	Cat.Nos	Supports for wiring accessories
1	6 531 79	Support for mounting Arteor, Mosaic and Belanko wiring accessories
1	6 531 78	Support adaptor for Mosaic wiring accessories 2 and 3 modules

Pack	Cat.Nos	Supports for  rail equipment (columns and mini-columns)
		For mounting  rail equipment (such as MCBs) on columns and mini-columns. To be used with two 0.5-module spacing units Cat.No 4 063 07 Capacity: 1 module Equipped with protective cover to prevent unwanted triggering
		For installation on universal columns and mini-columns use a fixing support Cat.No 6 531 79, a 4-module Mosaic Programme support plate Cat.No 0 802 52 and a 4-module Mosaic Programme plate Cat.Nos 0 788 14, 0793 14 or 0 790 54
5	0 310 69	White finish
5	0 307 87	Aluminium finish
5	6 530 75	Black finish



## Universal mini-columns and columns

### Dimensions (in mm)

1-compartment columns and mini-columns

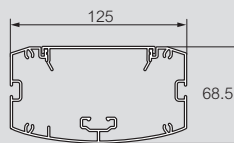

2-compartment columns and mini-columns

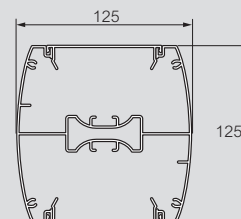

### Wiring capacity

1-compartment columns

	1-compartment	1-compartment (with 1 mechanism)
Max. capacity of conductors (for each type of conductor)		
Compartment	A	A
Total cross-section (mm <sup>2</sup> )	6900	5050
Number of cables	Ø7 mm	120
	Ø9 mm	72
	Ø11 mm	50

2-compartment columns

	2-compartment		2-compartment (with 1 mechanism)	
Max. capacity of conductors (for each type of conductor)				
Compartment	A	B	A	B
Total cross-section (mm <sup>2</sup> )	6170	6170	4280	6170
Number of cables	Ø7 mm	106	72	106
	Ø9 mm	62	42	62
	Ø11 mm	44	26	44

### Installation principle for special support for mounting rail equipment Cat.Nos 0 307 87, 0 310 69 and 6 530 75

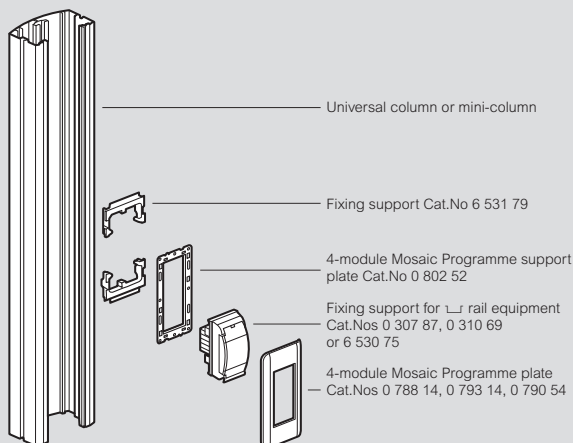



## FOLLOW US ON

@ legrand.com

 youtube.com/user/legrand

 facebook.com/Legrand

 twitter.com/Legrand

 pinterest.com/legrandgroup

 instagram.com/legrandnews



### Head Office

and International Department  
87045 Limoges Cedex - France  
Tel: +33(0)5 55 06 87 87  
Fax: +33(0)5 55 06 74 55