

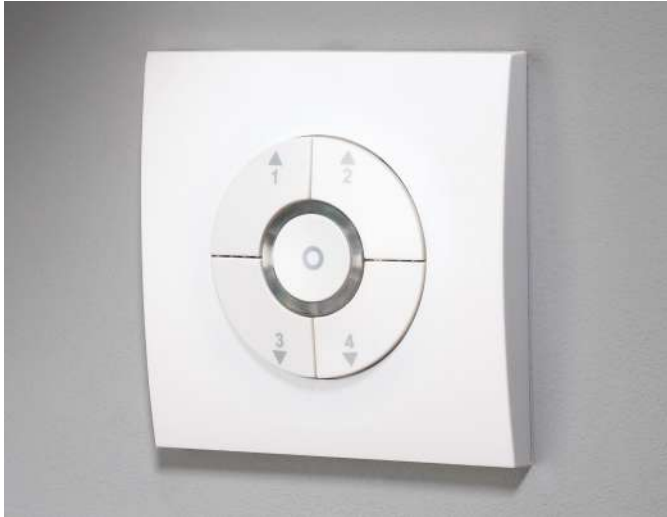

# DA-SG-4PM-W

## DALI / DSI dimmer switch

### Overview



The DA-SG-4PM-W is a single channel controller for DALI or DSI devices. The product has the following controls.

#### Scene buttons

Four buttons that offer 4 lighting levels. The default levels are:

- 1 - 100% brightness
- 2 - 75% brightness
- 3 - 50% brightness
- 4 - 25% brightness

These levels can be easily changed, see below.

#### Raise and lower function

Use either buttons 1 and 2 to raise the light level.  
Use either buttons 3 and 4 to lower the light level.

#### Off button

Toggle between lights off and last selected Scene.

*Note: the data sent from the DALI output is in broadcast mode and is not suitable for addressed systems.*

### Using the dimmer switch

#### Turning Lights On and Off

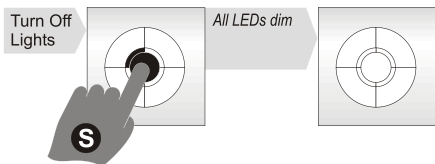
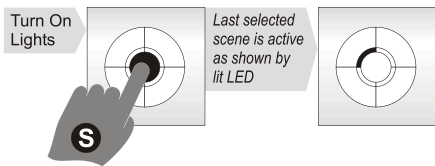

#### Selecting a Scene level

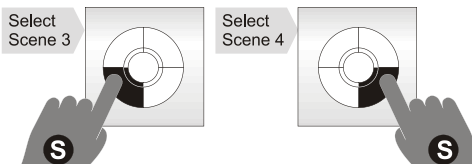
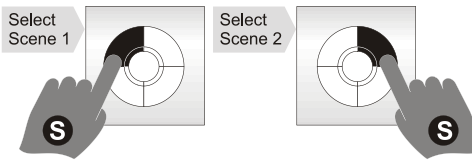

**KEY**

- S = Short Press
- L = Long Press (longer than 3 secs)
- H = Press and Hold

FULLY LIT or SINGLE FLASH

SLOW FLASH

LED RING

UNLIT / DIM

FAST FLASH

#### Programming Scenes

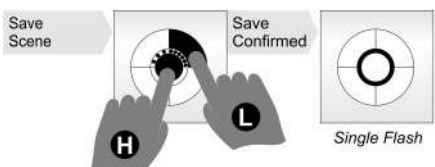
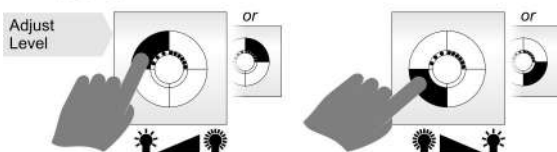
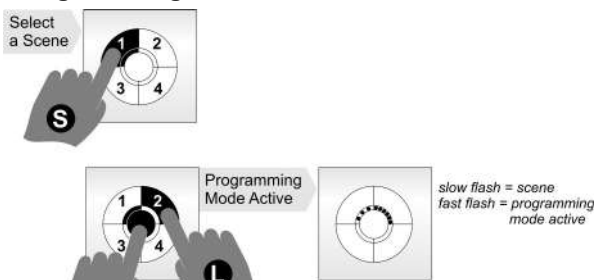

#### Adjusting Current Light Levels - Raise

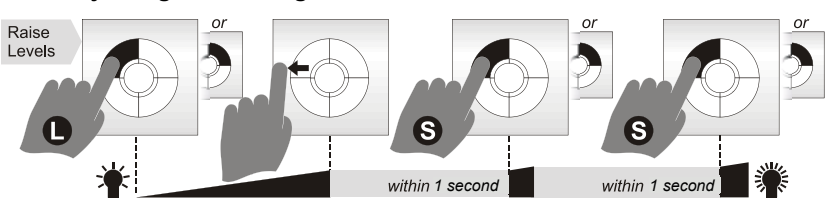

#### Adjusting Current Light Levels - Lower

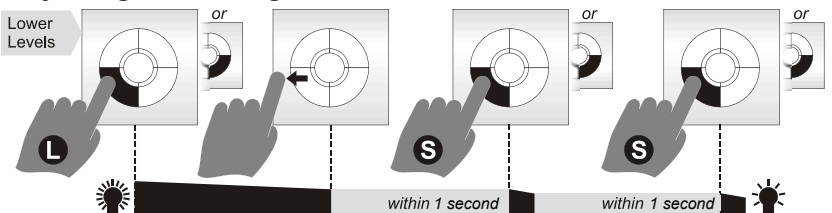

#### Changing from DALI to DSI

Default: DALI mode

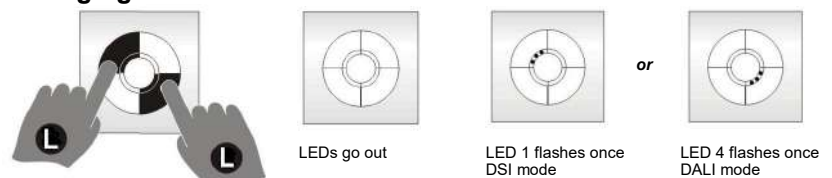

# Installation

Remove front cover by using a flathead screwdriver or similar to gently prise off the cover.



## Back box Compatibility

The DA-SG-4PM-W is designed to fit both UK and EU style backboxes.

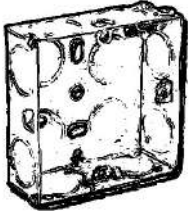

BS4662 square back box

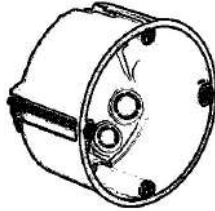

DIN standard round back box

## Mounting

Use the extender if there is less than 25mm free space. *Note: put the wires through the extender before connecting.*

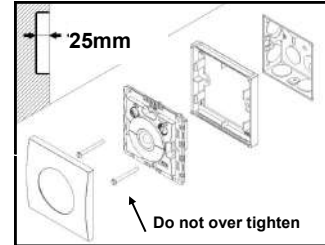

## Wiring

Connect to DALI / DSI device(s)

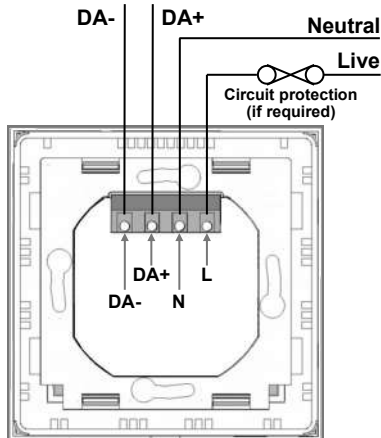

## Dimensions

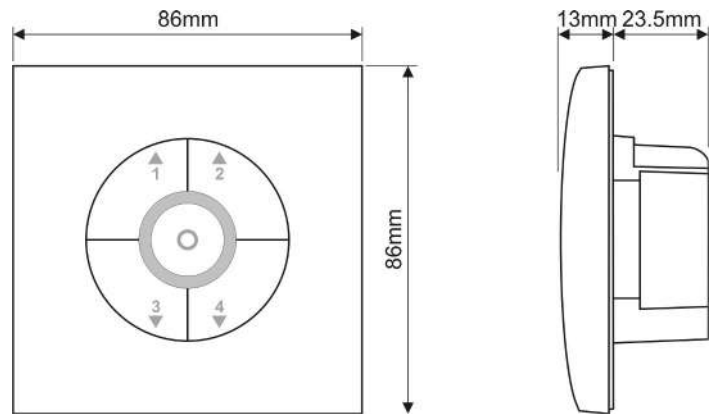

## Technical data

Supply Voltage	230VAC +/- 10%
Frequency	50Hz
Power consumption	On 528mW, Off 523mW
Load	20 DALI or DSI ballasts
Weight	0.1kg
Fixing method	Surface fixing : 35mm deep plastic surface mount moulded box. Flush fixing: 25mm steel backbox or

Temperature	-10°C to 35°C
Humidity	5 to 95% non-condensing
Material (casing)	Flame retardant ABS Type Class 2
Compliance	EMC-2014/30/EU LVD-2014/35/EU
For further compliance information visit <a href="http://www.cpelectronics.co.uk/compliance">www.cpelectronics.co.uk/compliance</a>	



## Part numbers

	Part number	Description
Dimmer switch	DA-SG-4PM-W	DALI / DSI dimmer switch - white
Accessories	GIFP-ST	GI fascia Silver
	GIFP-BZ	GI fascia Bronze
	UHS7	IR user handset

### IMPORTANT NOTICE!

This device should be installed by a qualified electrician in accordance with the latest edition of the IEE Wiring Regulations and any applicable Building Regulations.



**C.P. Electronics Ltd**  
Brent Crescent  
London  
NW10 7XR  
United Kingdom  
Tel: + 44 (0) 333 900 0671  
Fax: + 44 (0) 333 900 0674  
[www.cpelectronics.co.uk](http://www.cpelectronics.co.uk)  
[enquiry@cpelectronics.co.uk](mailto:enquiry@cpelectronics.co.uk)