



# Indoor Unit IP DES

*User and installation manual*

**bticino**



## Contents

<b>General information</b>	<b>5</b>
Warnings and recommendations	5
<b>Warnings and consumer rights</b>	<b>5</b>
<b>Fundamental concepts</b>	<b>6</b>
Naming of the devices	6
Community	6
Call addressing procedures	7
Call using the address in the Community	7
Call using the Alias (alphanumeric code)	8
Call using the Phonebook	8
Lift control function	8
CCTV cameras for passive video surveillance.	9
Address book	9
<b>Front and rear view</b>	<b>10</b>
<b>Dimensional data and installation heights</b>	<b>12</b>
<b>Installation</b>	<b>13</b>
<b>Uninstall</b>	<b>13</b>
<b>Example diagrams</b>	<b>14</b>
Ethernet connection	15
Fiber optic riser connection (case of higher bandwidth demand)	16
Intercom function	17
Lift control 1 - Lift control, 1 riser, 1 entrance panel	18
Lift control 2 - Lift control, multi riser, 1 entrance panel	19
Lift control 3 - Lift control, 1 riser, multi entrance panel	20
Available functions	21
<b>Use of the device</b>	<b>22</b>
Introduction	22
Home page	23
Lift	24
Alarm	25
Activity	27
<b>Video door entry functions</b>	<b>29</b>
Receive a call from EP	29
Receive a call from IU or GS	31
Call IU or GS	33
List of personal contacts	36
Add contact	36
Modify/delete contact	37
Call IU or GS using the contact list	39
Call history	40
Messages	42
Advertisement	43
Voice mail	43
Community	44
Access history	45
Family	45
Emergency	47
Camera	48
Alarm	50
Sensors	50

---

User settings	55
Access code	56
Ringtone	57
Preference	58
Language	59
Shortcut	59
User guide	61
Clean Mode	62
Advanced settings (Installation)	63
Function setting	65
Network test	67
Date & Time	69
Device in formation	69
Installation access code	70
Restore factory	71
Alarm setting	72
View access	75
<b>Firmware update</b>	<b>76</b>

## General information

### Warnings and recommendations

It is important to read this manual carefully before proceeding with the installation.

The warranty becomes automatically void in case of negligence, improper use, tampering by unauthorised personnel.

The Indoor Unit must only be installed indoors; it must not be exposed to water drops or splashes; it must be used only on IP DES systems.

## Warnings and consumer rights



Read carefully before use and keep for future reference.

Touching the units with wet hands is forbidden.

Using liquid cleaners or aerosols is forbidden.

Blocking the ventilation openings is forbidden.

Modifying the devices is forbidden.



Removing protective parts from the devices is forbidden.

Exposing the unit to water drops or splashes is forbidden.

Installing the units near heat/cold sources or hot/cold air emission points is forbidden.

Installing the units near heat/cold sources is forbidden.

Installing the units near harmful gases and powders is forbidden.

Fastening the units on unsuitable surfaces is forbidden.



Danger of electrical shock.



Risk of devices falling because the surface on which they are installed collapses or inappropriate installation.

Switch the power supply OFF before any work on the system.



Caution: Installation, configuration, starting-up and maintenance must be performed exclusively by qualified personnel.

Check that the wall installation has been carried out correctly according to the installation instructions.

Check that the unit installation complies with the standards in force.

Connect the power supply wires as indicated.

Use only the items indicated in the technical specifications for any system expansions.

## Fundamental concepts

### Naming of the devices

In this manual, for easy reading, the abbreviated device name is used as in the list.

- IU: Indoor Unit
- EP: Entrance Panel
- GS: Guard Station
- SD: Server DES
- SEP: Small Entrance Panel
- AB: Address book
- SW: Software Server DES

### Community

The term Community means the housing complex reproduced in the project design made using the SW.

The structure in its maximum extension includes:



## Call addressing procedures

On the basis of data recorded in the AB and the Community structure the calls can be made using various methods:

- call using the address in the Community;
- call using the Alias (alphanumeric code);
- call using the Phonebook.

## Call using the address in the Community

To make this type of call you must know the address of the person being called, which depends on the community structure, for example:

- to call the IU highlighted in the diagram from the «A» EP, enter the corresponding address «11010402»;
- to call the IU highlighted in the diagram from the «B» EP, enter the corresponding address «010402», as the IU is positioned inside building 1 and therefore it is sufficient to type the Riser, Floor and Apartment number.

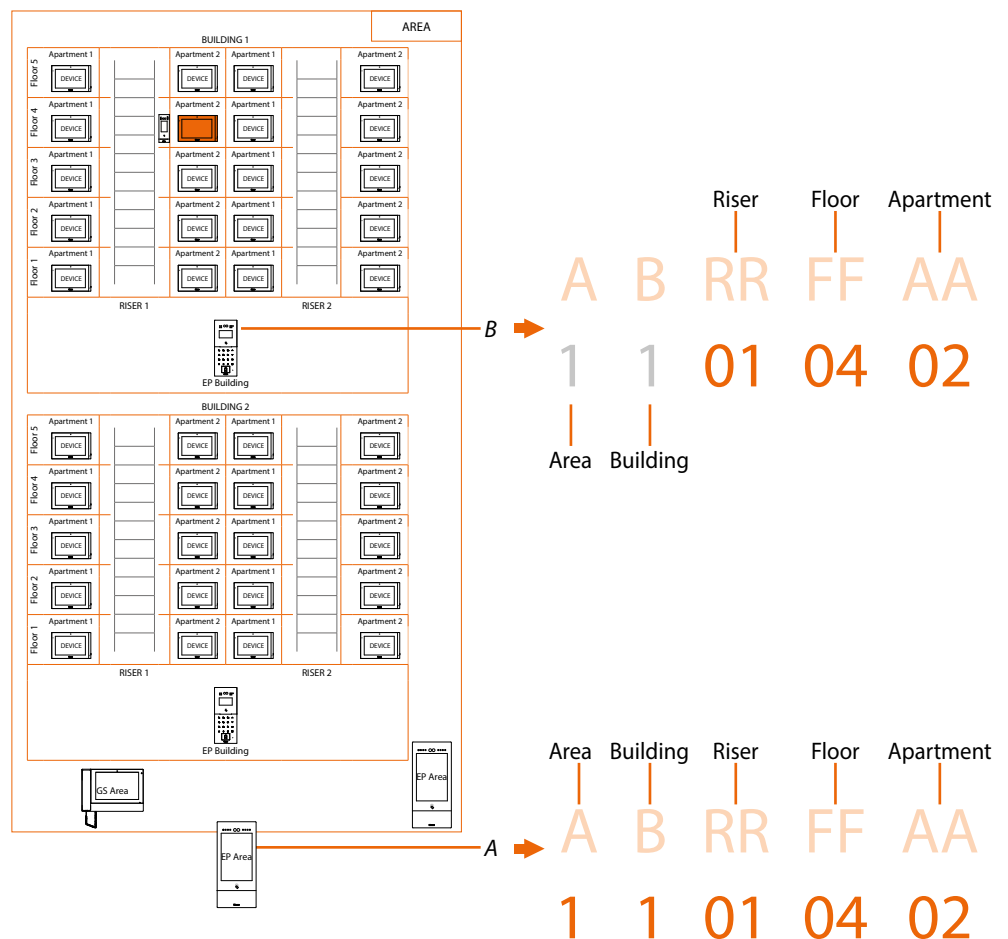

**Note:** during the configuration phase, the number of digits to be used for each call sector (Area/ Building/Riser/Floor/Apartment) must be set.

Example: I have to call an apartment inside building 2

- if there are from 1 to 9 buildings in the area, I must enter «2» (one digit used for the Building call sector);
- if there are more than 10 buildings in the area, I must enter «02» (two digits used for the Building call sector);

The system will automatically show the correct number of digits to type and which data to enter on the basis of the EP position you are calling from, for example Area (2 01 06 02) or Building (01 06 02)

System configuration (default)

Areas 9, Building 99, Riser 99, Floor 99, Apartment 99

It is possible to modify the limits using the SW (see SW manual for details)

## Call using the Alias (alphanumeric code)

The alphanumeric code, by default, is the same address as in the Community but it is possible to replace it with an alias using the SW. For more details see the Software manual.

Example:

1 1 01 04 02 ➔ B12

## Call using the Phonebook

In this way it is possible to use the phonebook key and select the contact to call or it is possible to make a call by typing the code (Alias), with the advantage that during typing the system will autocomplete the address; see the software Manual for more detail.

Example:

1 1 01 04 02 ➔ JOHN SMITH

## Lift control function

The Lift control function allows a command to be sent to the lift control centre to simulate a lift call.

The lift action depends on the functions of the lift control unit (BTicino cannot define these functions. They depend on the lift manufacturers).

It is necessary to enable the function in [settings/installation/function](#)

It is possible to display some wiring diagram examples in the [Example diagrams/lift control](#) section. For more information, see the «Lift Control Interface item 375010 software manual».

## **CCTV cameras for passive video surveillance.**

The IP DES system is compatible with the CCTV cameras with OnVif protocol

## **Address book**

Phonebook, created using the SW, containing the addresses of all the system devices.

TIMES		
Function	Default time	Customisation using SW
Call duration	120 seconds	From 60 to 120 seconds
Screen saver	120 seconds	From 10 to 120 seconds
Ringtone duration	35 seconds	From 19 to 35 seconds
Day Time	4 hours	From 1 to 12 hours
Night Time	6 hours	From 1 to 12 hours
Alarm Delay	40 seconds	From 0 to 255 seconds
Arming Delay	40 seconds	From 0 to 255 seconds

---

## Front and rear view

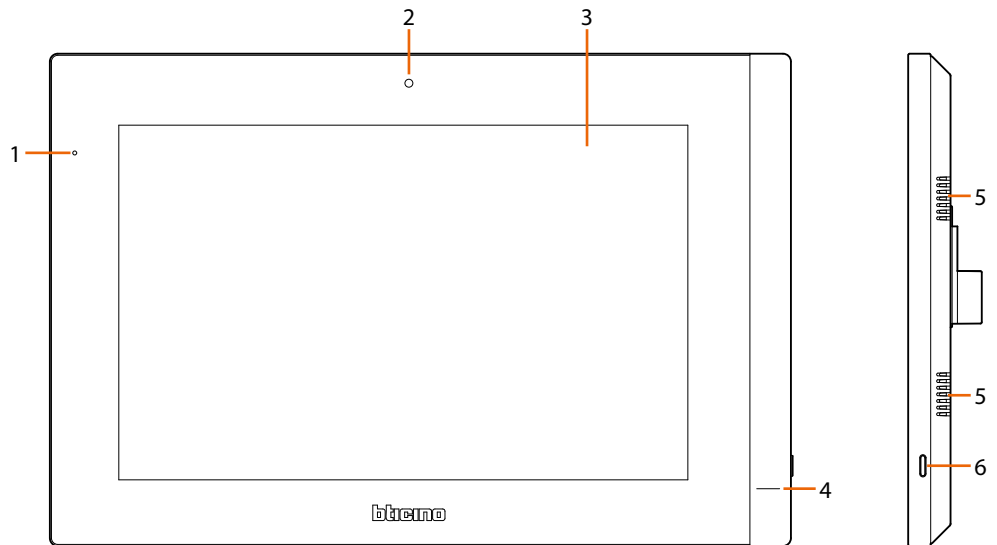

1. Microphone
2. Camera (only 373001 / 02)
3. Display 7/10" (touch screen)
4. Notification LED  
LED flashing= notification of a message
5. Loudspeaker
6. SOS push button

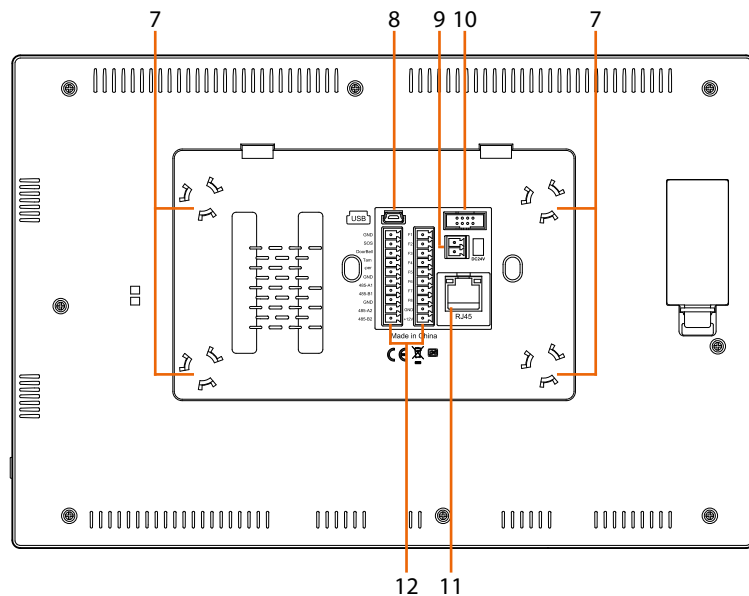

7. Fixing magnets for bracket
8. USB Connector (not used)
9. Additional power supply clamps (not polarized)
10. Not used
11. RJ45 Connector \*
12. Connection clamp

**\*Attention:** this device does not support standard POE power supplies, but only POE power supplies identified with 375005.  
Connect the cat5/5e/6 FTP or cat5/5e/6 UTP cable with ferrite supplied to the connector.

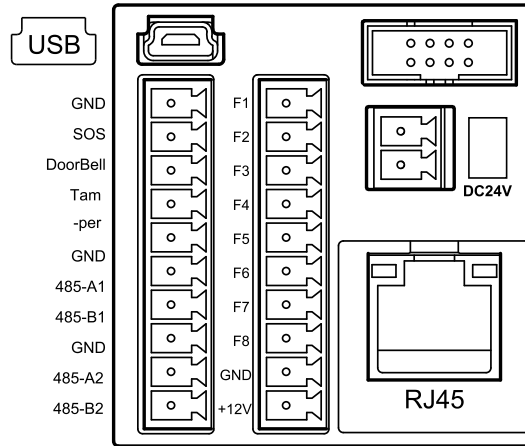

Connection clamps			
SOS – GND	Additional SOS call	F1 – GND	Infrared
DoorBell – GND	Door bell call	F2 – GND	Magnetic contact
Tamper – GND	Tamper	F3 – GND	Smoke sensor
GND		F4 – GND	Gas sensor
485-A1		F5 – GND	Water sensor
485-B1	future use	F6 – GND	Magnetic contact
GND		F7 – GND	Magnetic contact
485-A2		F8 – GND	SOS
485-B2		+12V – GND	12Vdc, maximum 150 mA sensor power supply

It is possible to display some wiring diagram examples in the [Example diagrams/functions](#) section

## Dimensional data and installation heights

\* Recommended height, unless different regulations are specified.

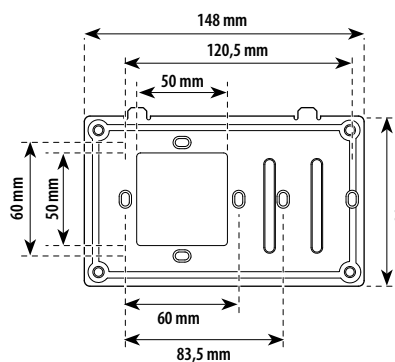
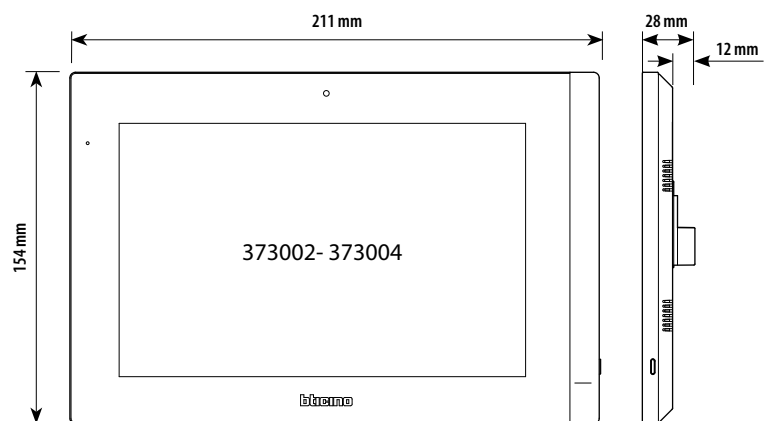
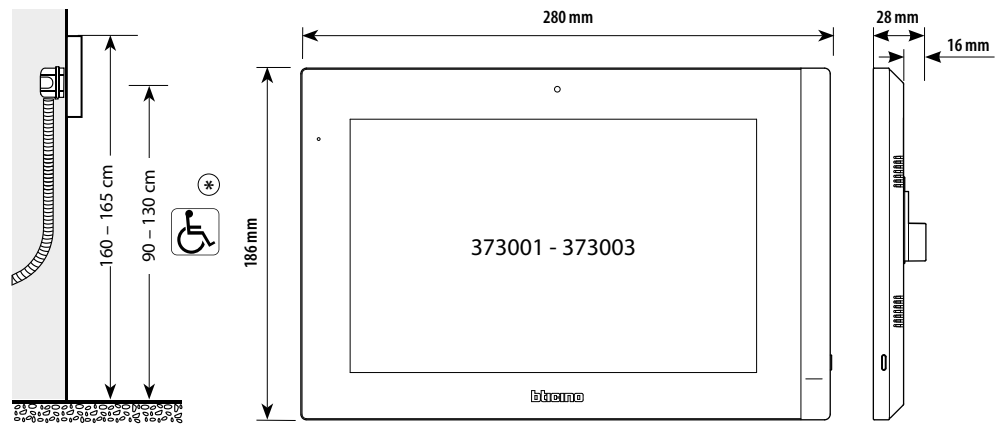

## Installation

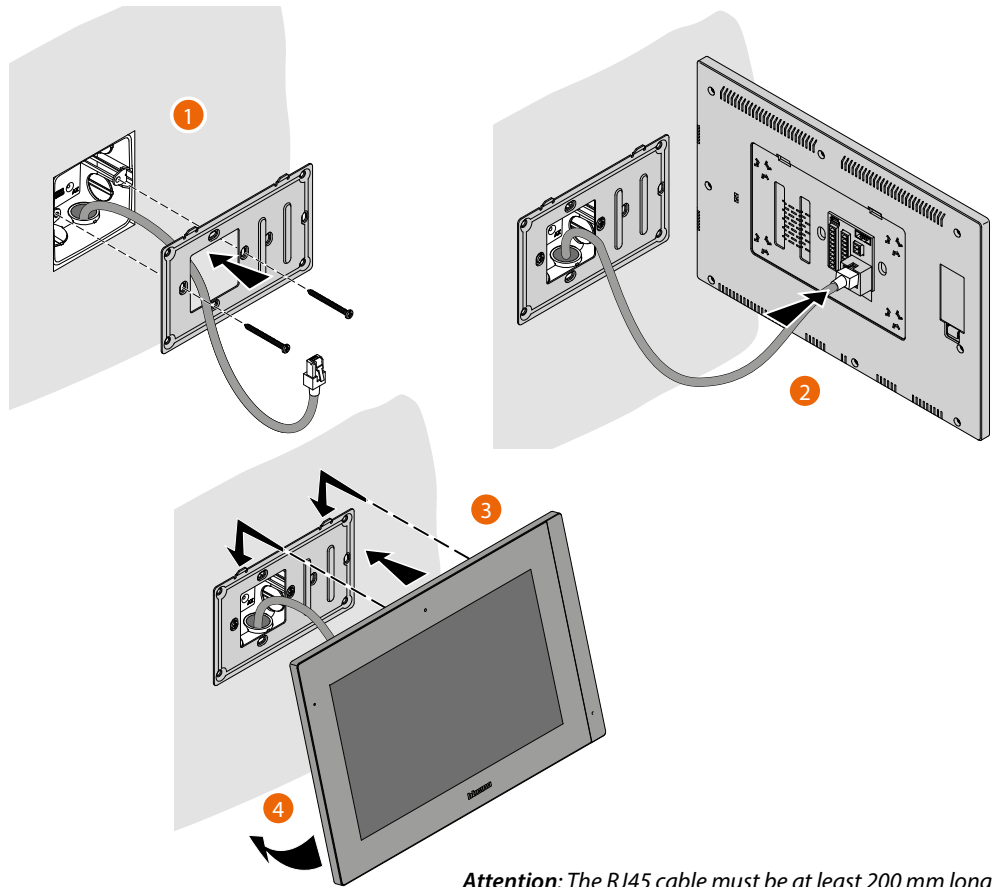

*Attention: The RJ45 cable must be at least 200 mm long*

## Uninstall

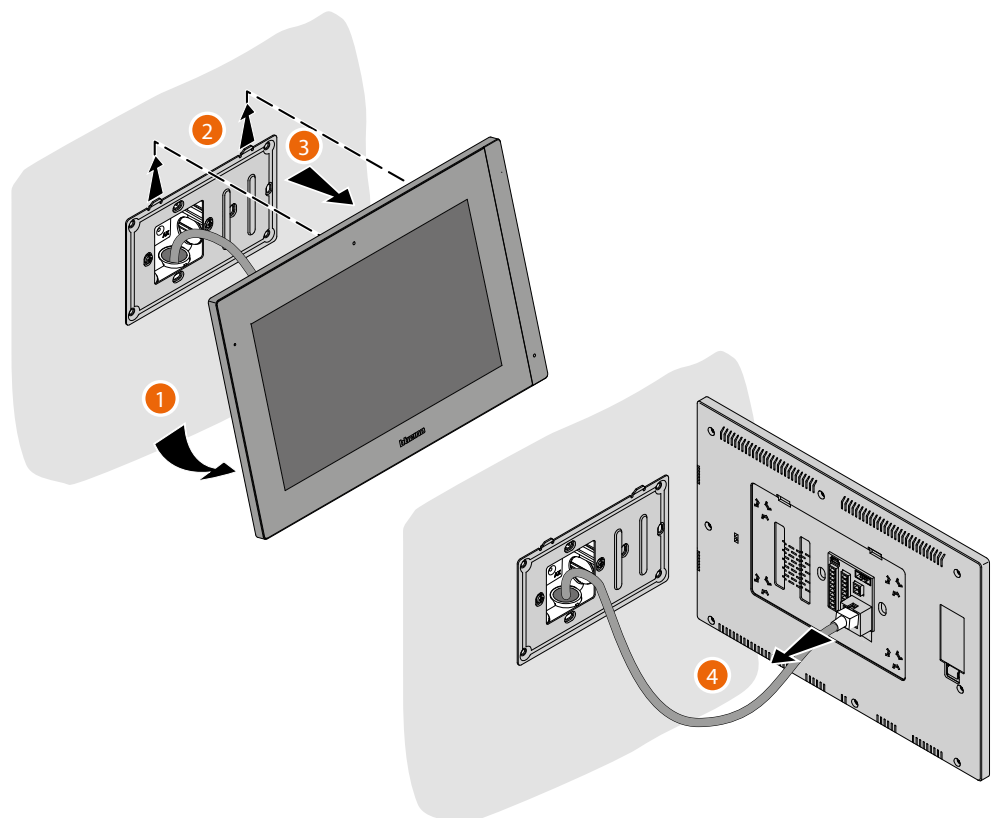

## Example diagrams

CABLES LEGEND	LAN PoE BTicino	LAN Ethernet	Copper cables	2 x Copper cables
---------------	-----------------	--------------	---------------	-------------------

It is possible to use two different types of connection according to installation situation:

A - Diagram with power supply by BTicino PoE Switch

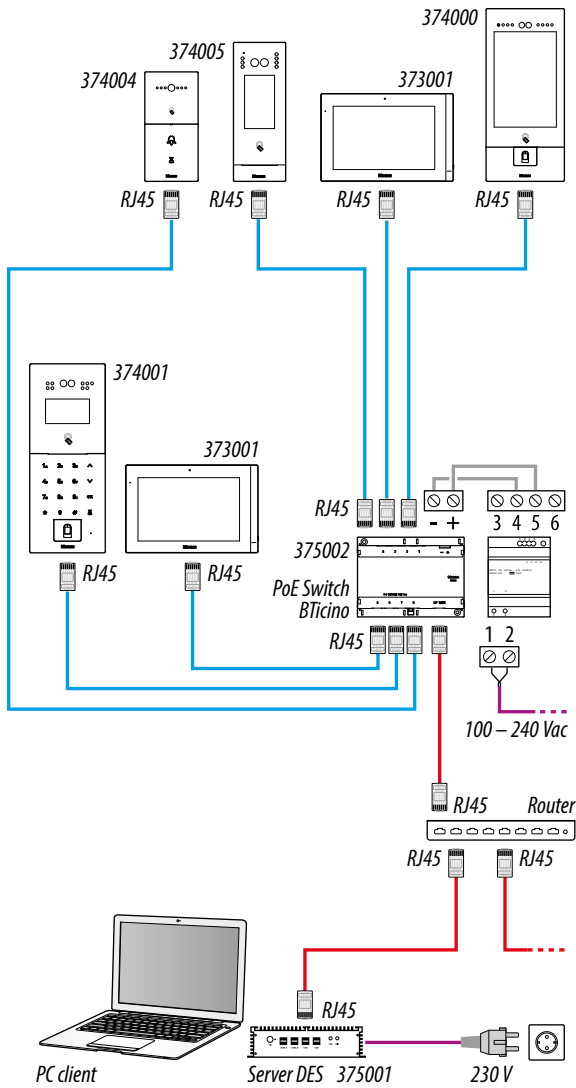

B - Diagram with local power supply

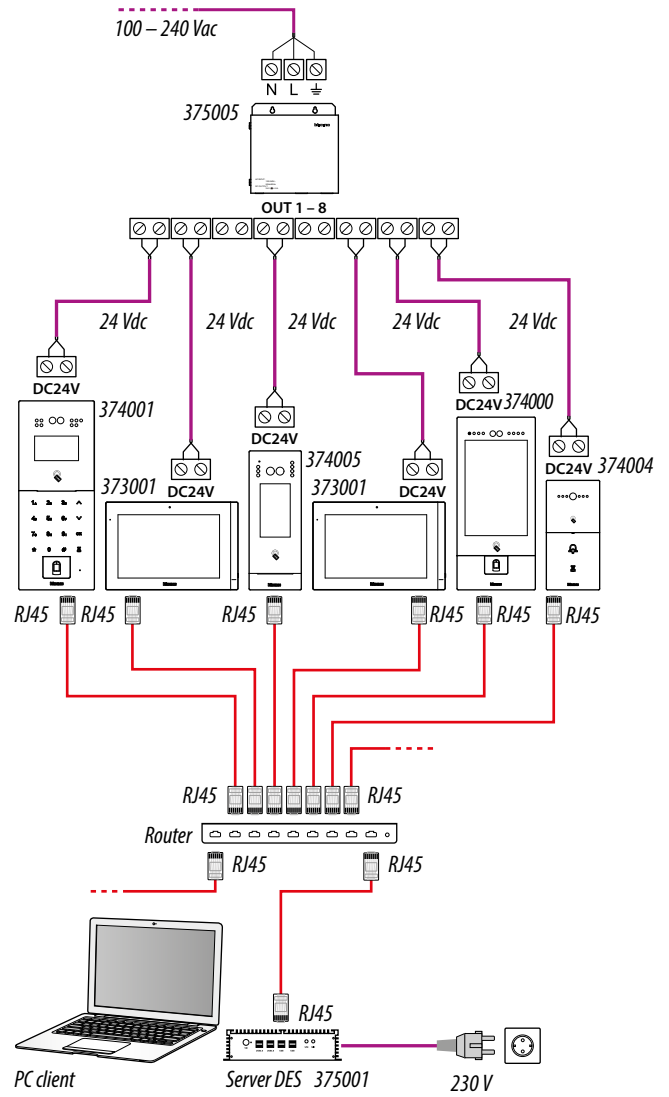

**Attention:** this device does not support standard POE power supplies, but only POE power supplies identified with 375002. Connect the cat5/5e/6 FTP or cat5/5e/6 UTP cable with ferrite supplied to the connector.

**Attention:** do not directly connect PoE ports to an unsuitable network interface, such as a device powered by a different voltage. Connect the UP LINK port to a suitable port, never to a PoE port.

**Note:** maximum length of every LAN permanent link line = 90 m.

### Ethernet connection

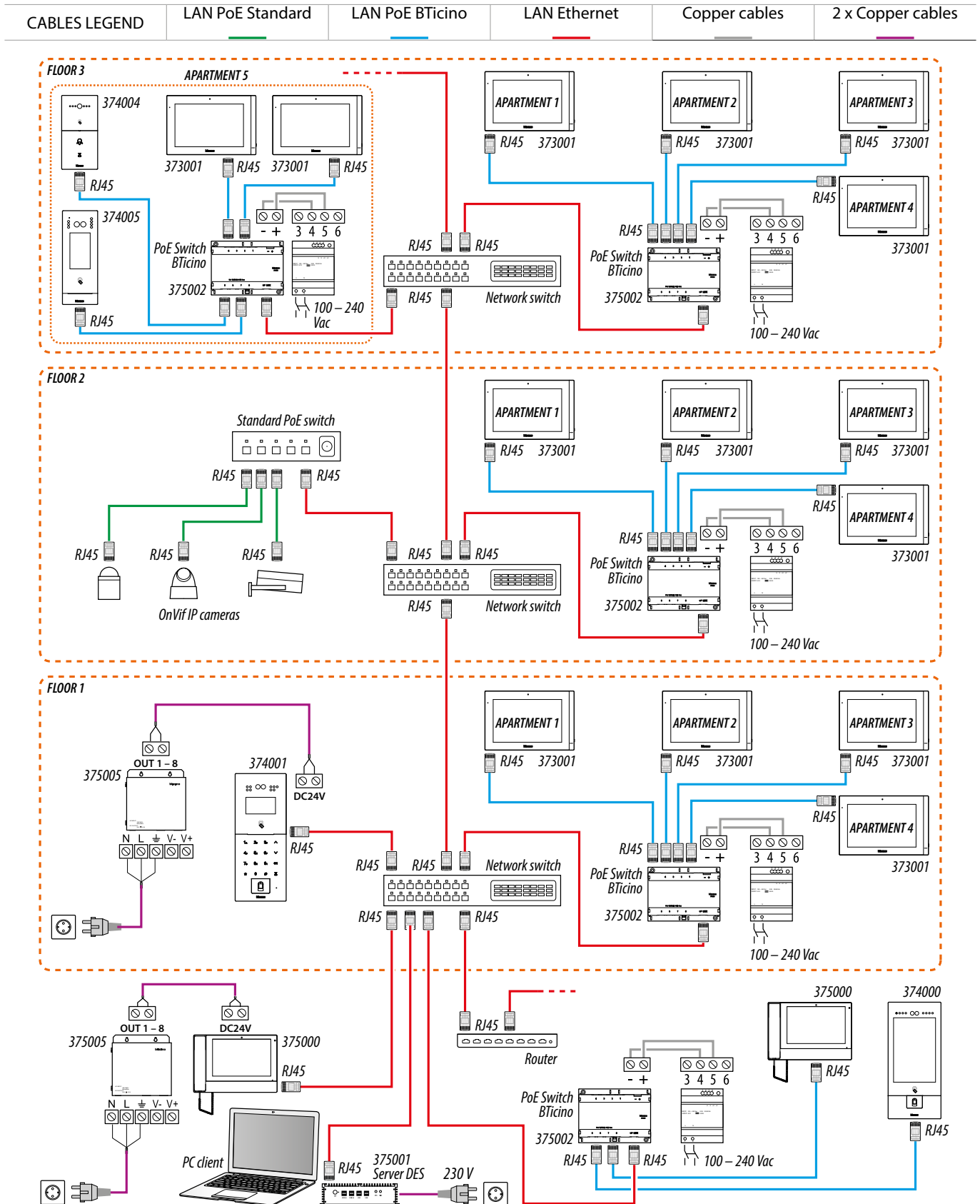

**Note:** to connect the devices it is possible to use both types of wiring (diagram A or diagram B) or even mixed ones.

**Attention:** do not directly connect PoE ports to an unsuitable network interface, such as a device powered by a different voltage. Connect the UP LINK port to a suitable port, never to a PoE port.

# Indoor Unit IP DES

User and installation manual



## Fiber optic riser connection (case of higher bandwidth demand)

CABLES LEGEND	LAN PoE Standard	LAN PoE BTicino	LAN Ethernet	Optical fiber	Copper cables	2 x Copper cables
---------------	------------------	-----------------	--------------	---------------	---------------	-------------------

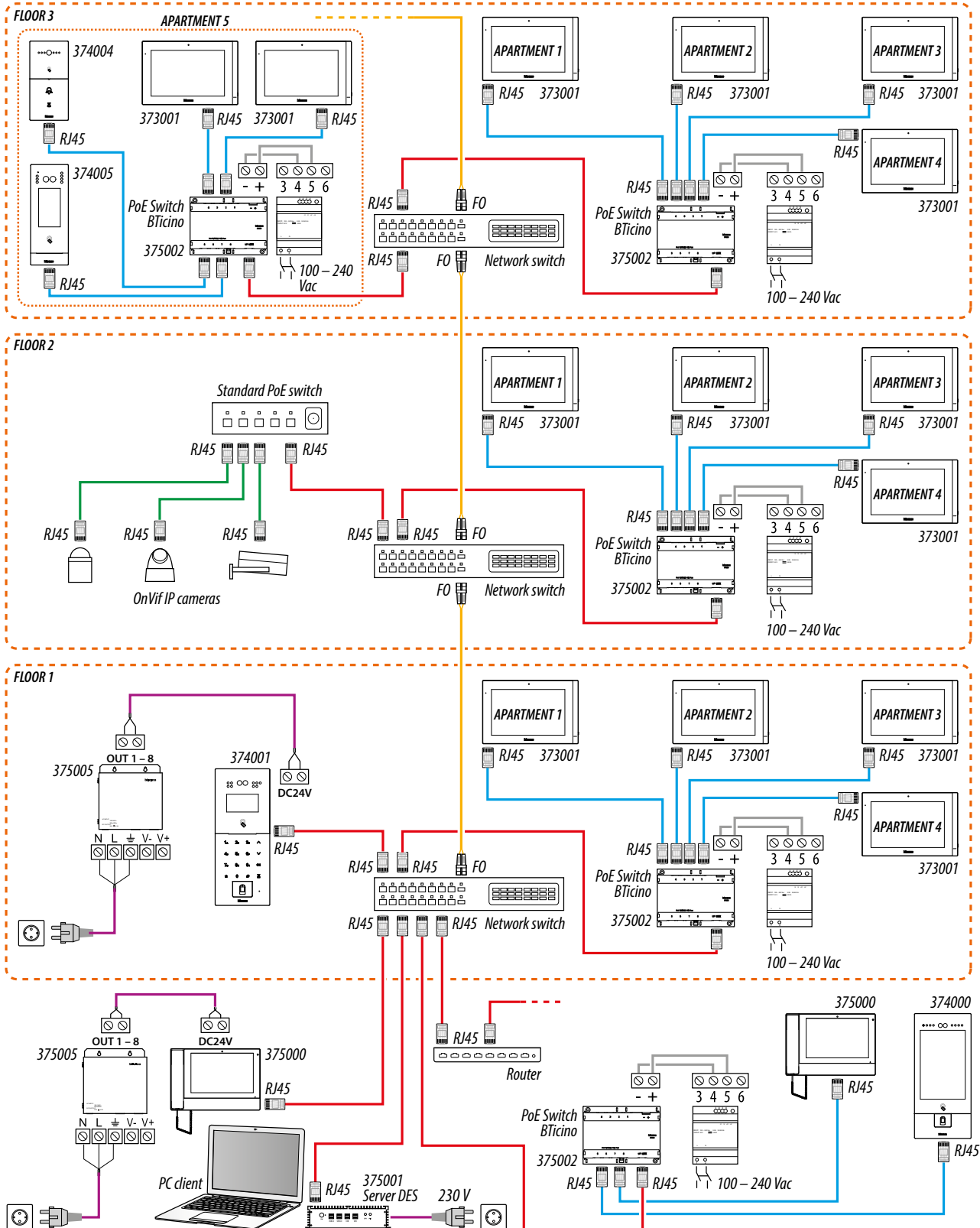

**Attention:** do not directly connect PoE ports to an unsuitable network interface, such as a device powered by a different voltage. Connect the UP LINK port to a suitable port, never to a PoE port.

**Note:** to connect the devices it is possible to use both types of wiring (diagram A or diagram B) or even mixed ones.

## Intercom function

Audio intercom between internal unit:

- ❶ - of different apartments (same building or different building)
- ❷ - inside the same apartment.

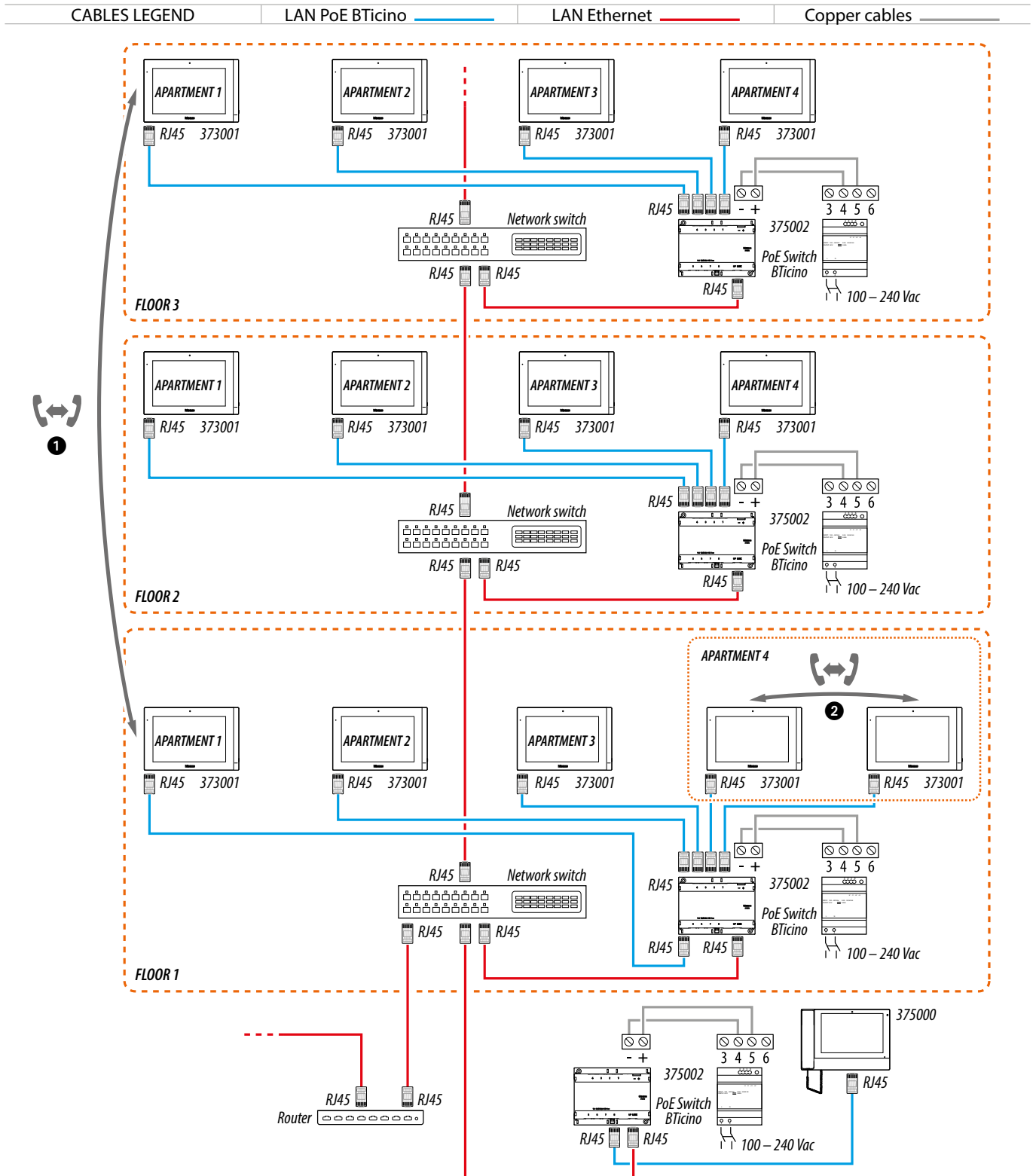

**Attention:** do not directly connect PoE ports to an unsuitable network interface, such as a device powered by a different voltage. Connect the UP LINK port to a suitable port, never to a PoE port.

**Note:** to connect the devices it is possible to use both types of wiring (diagram A or diagram B) or even mixed ones.

# Indoor Unit IP DES

User and installation manual



## Lift control 1 - Lift control, 1 riser, 1 entrance panel

CABLES LEGEND	LAN PoE BTicino <span style="color: blue;">—</span>	LAN Ethernet <span style="color: red;">—</span>	Copper cables <span style="color: gray;">—</span>	2 x Copper cables <span style="color: purple;">—</span>
---------------	---	---	---	---

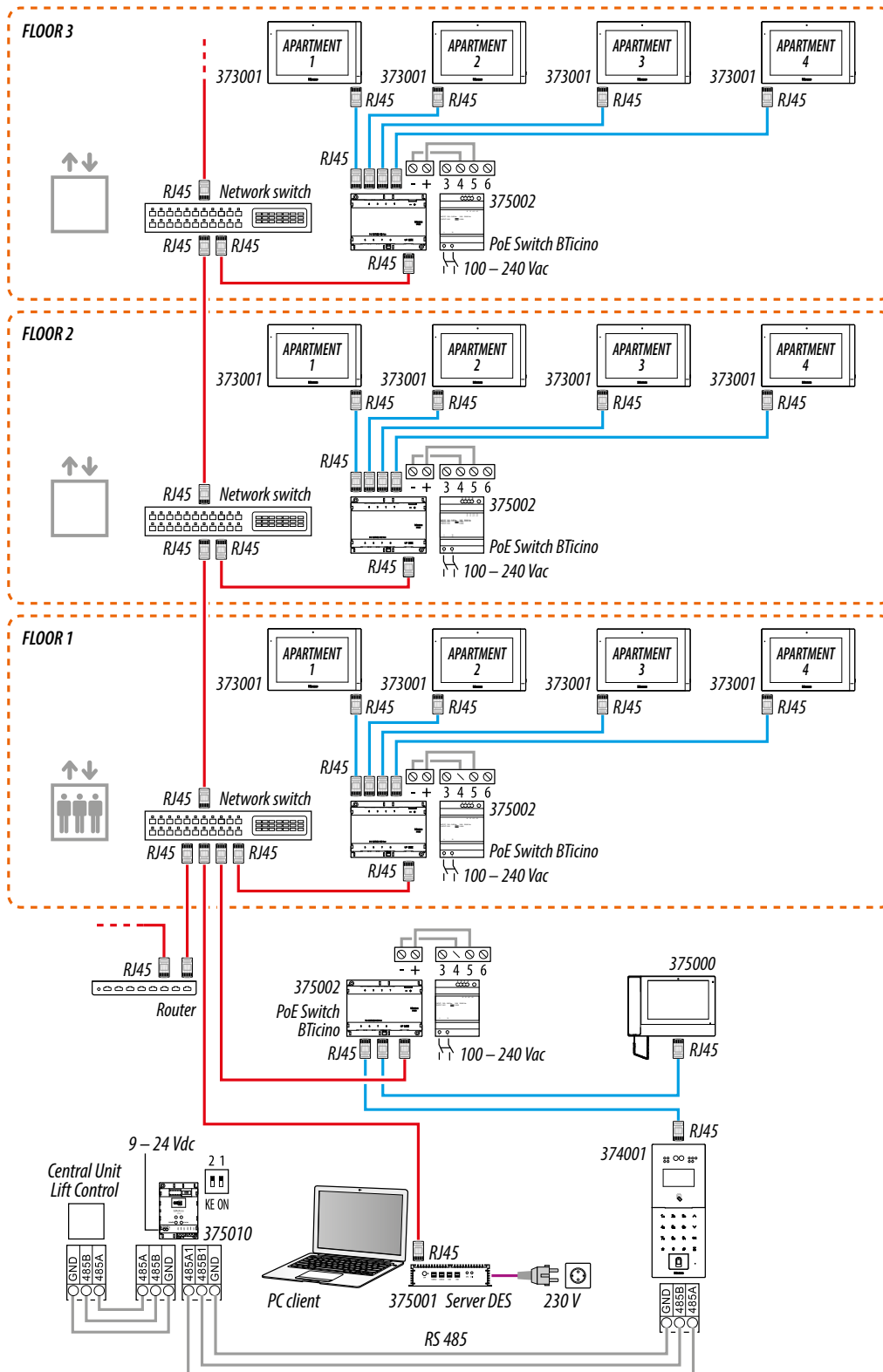

**Attention:** do not directly connect PoE ports to an unsuitable network interface, such as a device powered by a different voltage. Connect the UP LINK port to a suitable port, never to a PoE port.

**Note:** to connect the devices it is possible to use both types of wiring (diagram A or diagram B) or even mixed ones.

## Lift control 2 - Lift control, multi riser, 1 entrance panel

CABLES LEGEND	LAN PoE BTicino	LAN Ethernet	Copper cables	2 x Copper cables
---------------	-----------------	--------------	---------------	-------------------

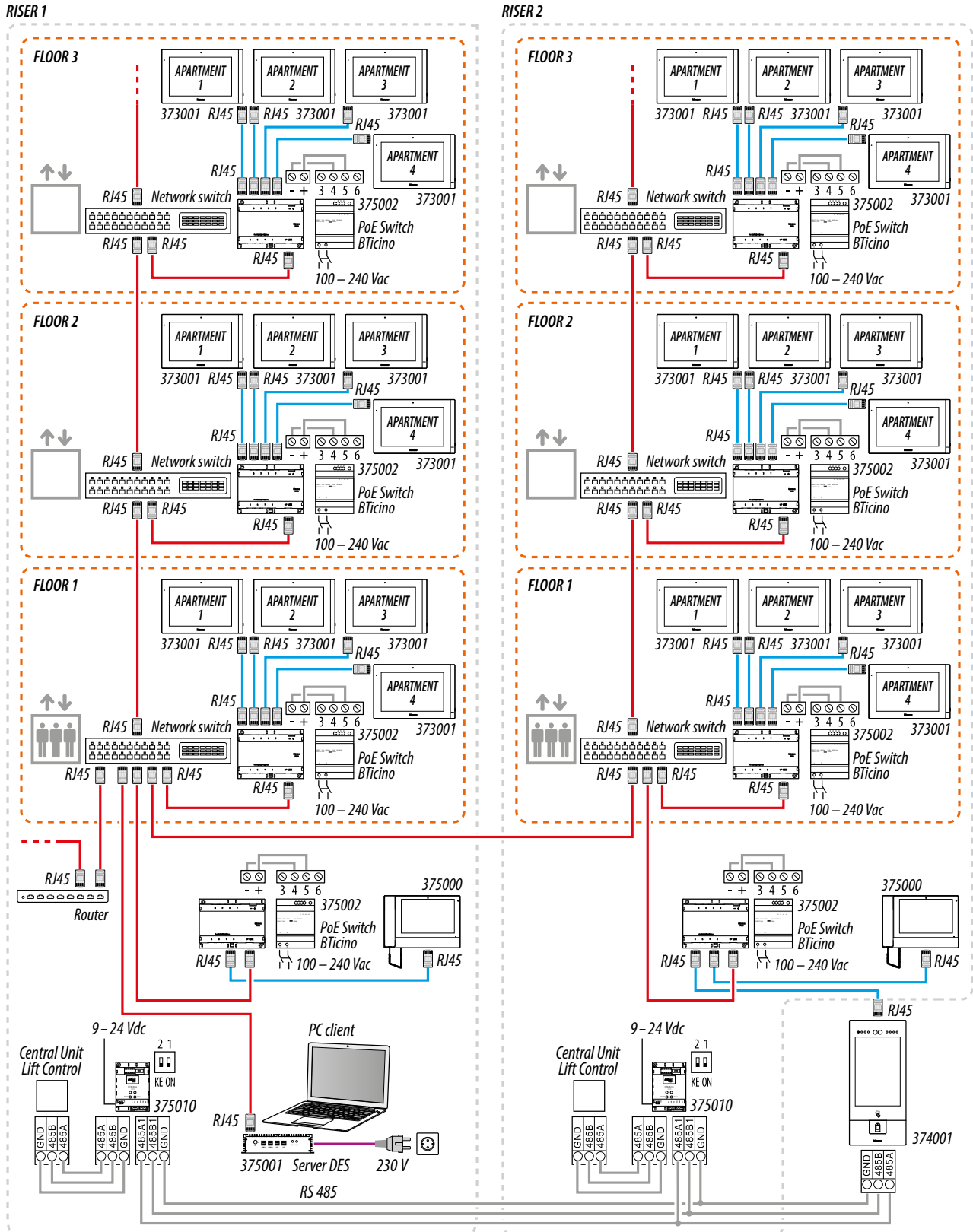

**Attention:** do not directly connect PoE ports to an unsuitable network interface, such as a device powered by a different voltage. Connect the UP LINK port to a suitable port, never to a PoE port.

**Note:** to connect the devices it is possible to use both types of wiring (diagram A or diagram B) or even mixed ones.

# Indoor Unit IP DES

User and installation manual



## Lift control 3 - Lift control, 1 riser, multi entrance panel

CABLES LEGEND	LAN PoE BTicino	LAN Ethernet	Copper cables	2 x Copper cables

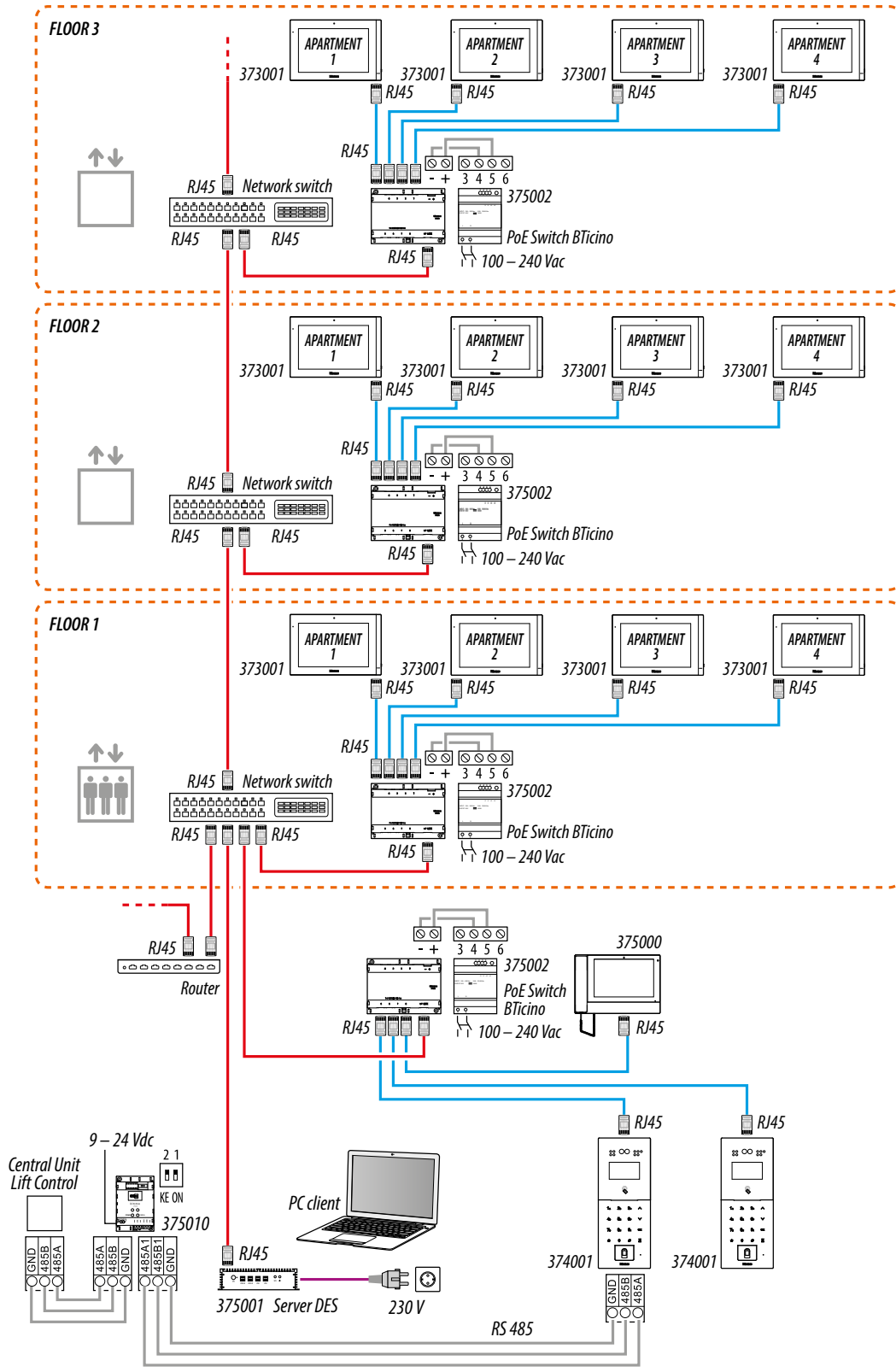

**Attention:** do not directly connect PoE ports to an unsuitable network interface, such as a device powered by a different voltage. Connect the UP LINK port to a suitable port, never to a PoE port.

**Note:** to connect the devices it is possible to use both types of wiring (diagram A or diagram B) or even mixed ones.

## Available functions

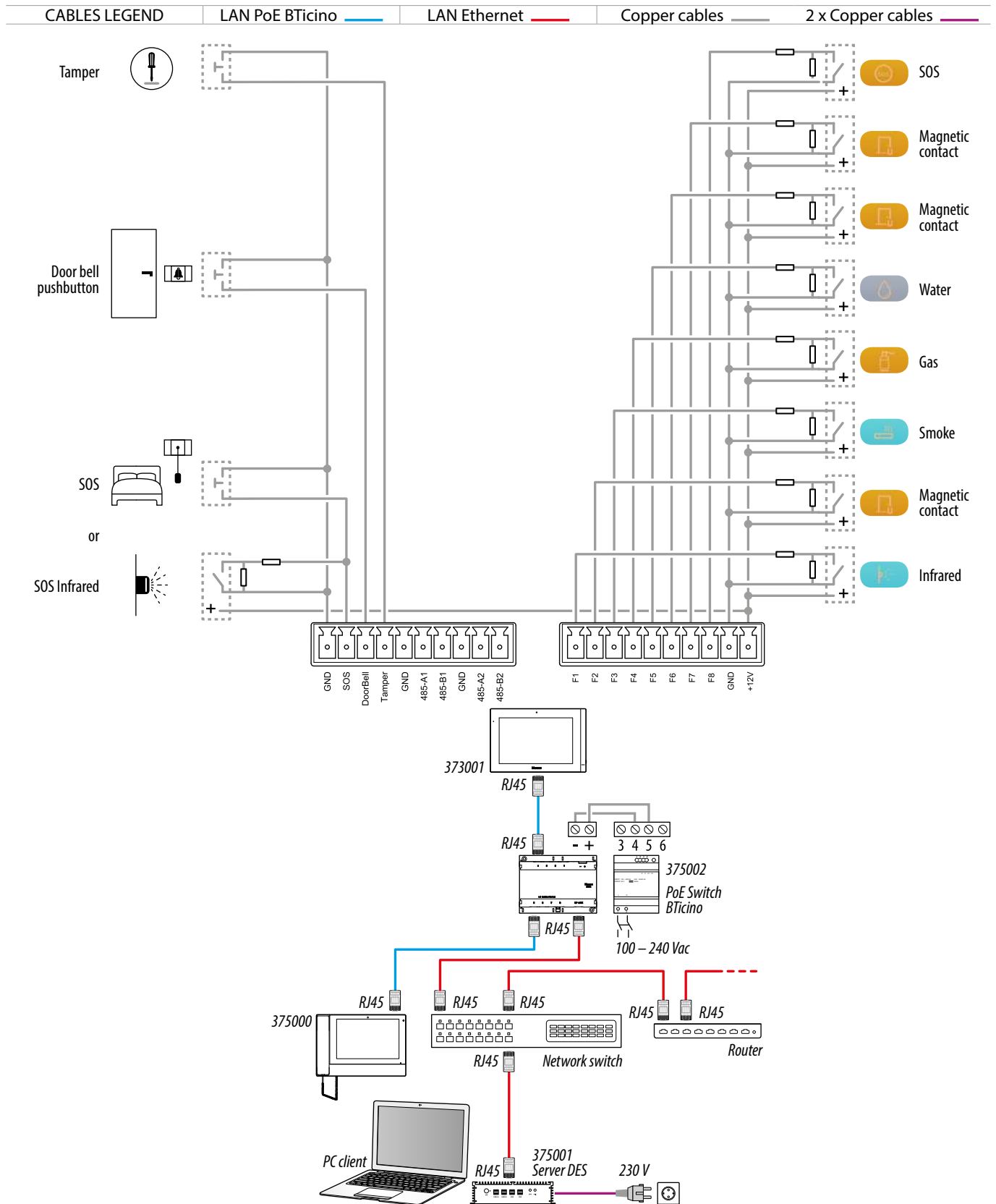

**Attention:** do not directly connect PoE ports to an unsuitable network interface, such as a device powered by a different voltage. Connect the UP LINK port to a suitable port, never to a PoE port.

**Note:** the alarm functions are the default ones. It is possible to modify them in the appropriate section.

**Note:** Use the supplied resistors (560 Ohm  $\pm 5\%$ , 1/4 W).

**Note:** to connect the devices it is possible to use both types of wiring (diagram A or diagram B) or even mixed ones.

## Use of the device

### Introduction

After the installation and connection of the device, it is necessary to configure it and create the Community structure. For details see Server DES Software manual.



- Step **01** Community VLAN network creation
- Step **02** Community structure definition
- Step **03** Community structure creation
- Step **04** Device MAC address registration
- Step **05** Forwarding of the phonebook to the Server DES
- Step **06** Installation of the devices
- Step **07** Activation of the devices
- Step **08** System test

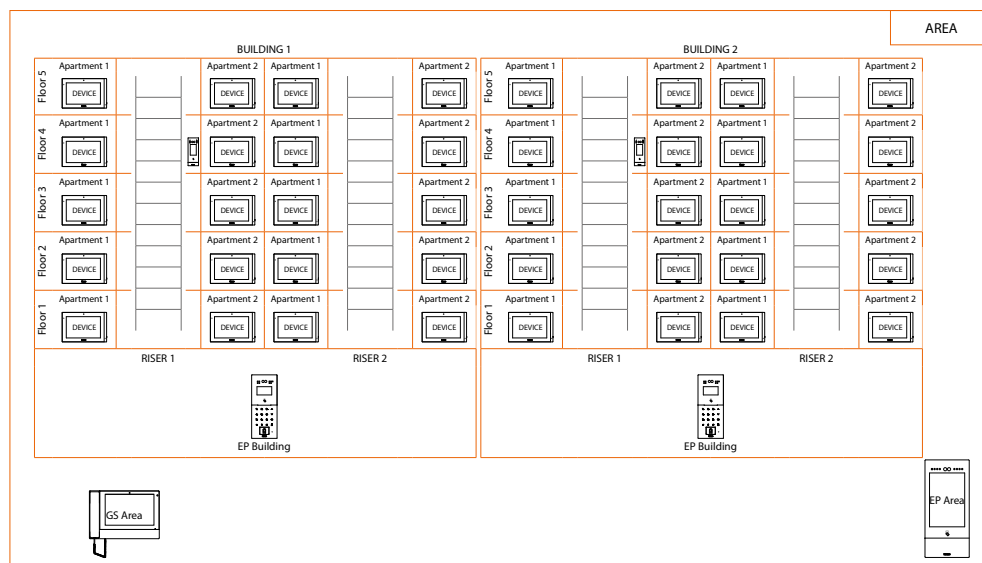

## Home page





This page may show different content according to the configuration and systems connected to the device.

The Home Page, with all the functions enabled, is shown below.





A Current date and time





B Favourites keys

	<b>Call lift</b>	It calls the lift
	<b>Silent ringtone</b>	It silences the ringtone manually or by hourly scheduling
	<b>Activity</b>	It activates/deactivates all the sensors except activity check and 24h
	<b>Alarm</b>	It activates/deactivates the activity check sensor

C Status icons

	No IP addressing conflict
	IP addressing conflict (same address assigned to 2 or more devices)
	When visible, communication between the device and the SD is active

D Function keys

	Call section	It opens the call section where it is possible to <a href="#">make calls to the IU and GS</a> , manage the <a href="#">list of personal contacts</a> and see <a href="#">the call list</a>
	Message section	It displays different <a href="#">types of messages and the video door entry answering machine</a>
	Camera section	It displays the <a href="#">CCTV</a> and <a href="#">EP cameras</a>
	Alarm section	It manages the <a href="#">alarm system</a> sensors and displays the list of the detected alarms
	Settings	It opens the section where it is possible to perform the <a href="#">user settings</a> and <a href="#">installer settings</a>



## Lift

This function calls the lift.

This function is active only if there is a **Lift control** item 375010 in the community. For more information, see the «Lift Control Interface item 375010 software manual».

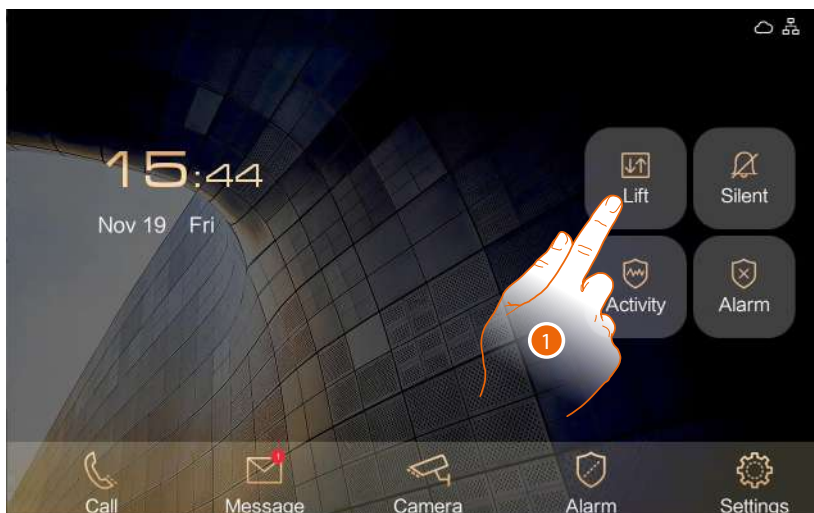

1. Touch to call the lift

A confirmation message appears

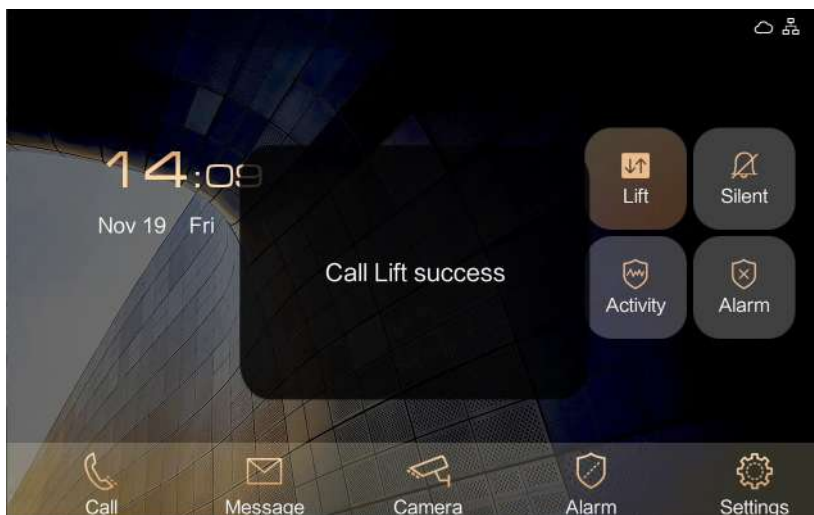



## Alarm

In this section, it is possible to activate at the same time all the sensors of the alarm system connected to clamps F1 to F8 (see the [Alarm paragraph](#)).



1. Touch to activate the alarms.



2. Alarms are now active, touch to disarm them.

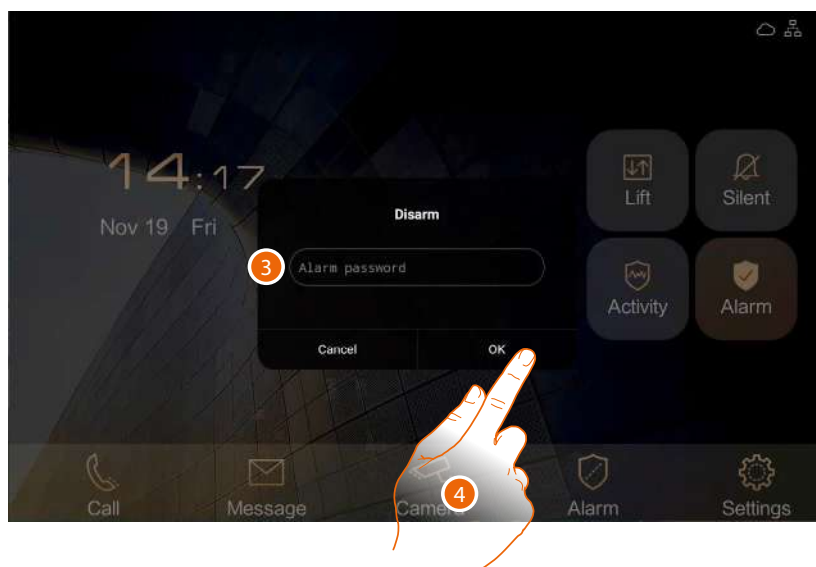

3. Enter the alarm password (default 2000)

4. Touch to confirm

A message indicates that the operation has been carried out

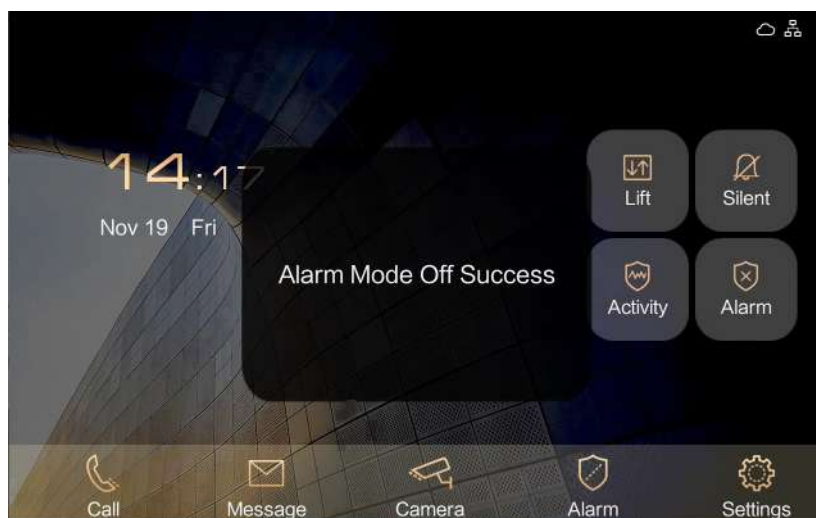



## Activity

This function allows to activate the Activity check sensor (see the [Alarm paragraph](#)).



1. Touch to activate the function



2. The Activity check sensor is now active, touch to disable it

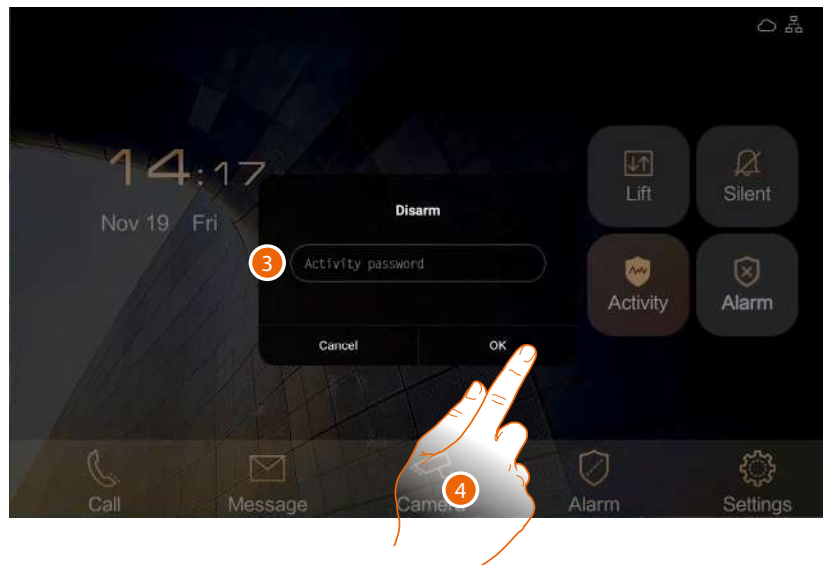

3. Enter the activity password (default 2000)

4. Touch to confirm

A message indicates that the operation has been carried out

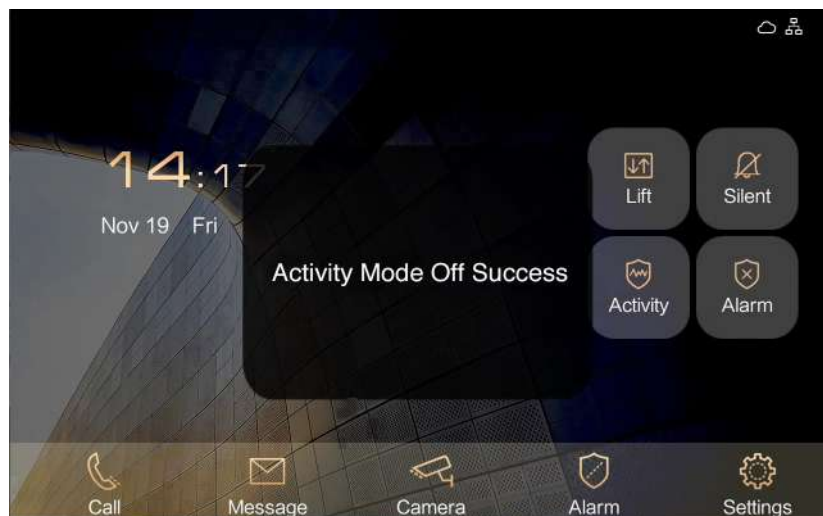

## Video door entry functions

### Receive a call from EP

When a call comes in, the display of the EP is activated, showing the image taken.

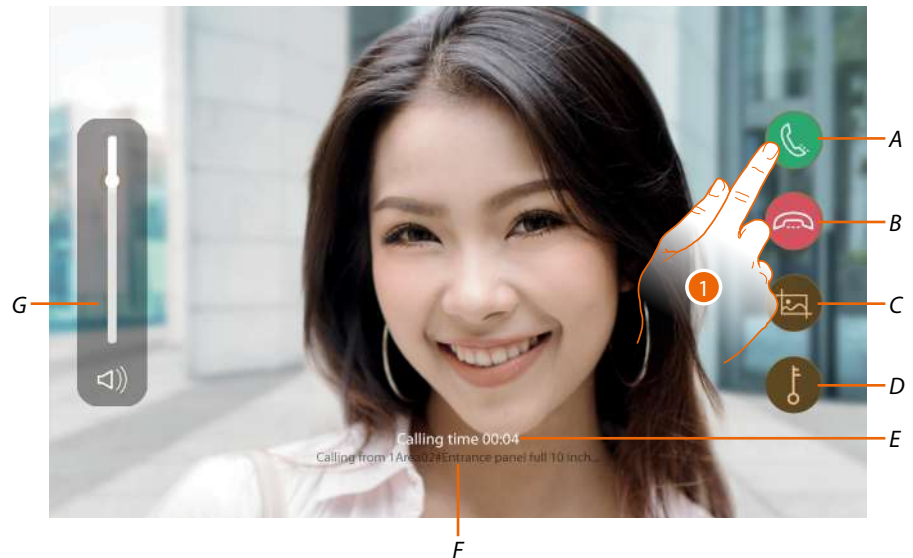

- A It answers the call
  - B It rejects the call or ends the communication
  - C It captures an image
  - D It opens the door lock
  - E Calling time
  - F Address of the device from which the call comes
  - G It adjusts the volume
1. Touch to answer the call



2. Touch to capture an image of the screen
- A confirmation message appears, the image will be saved in [Message/Voice mail](#) and in [Call/call history](#)

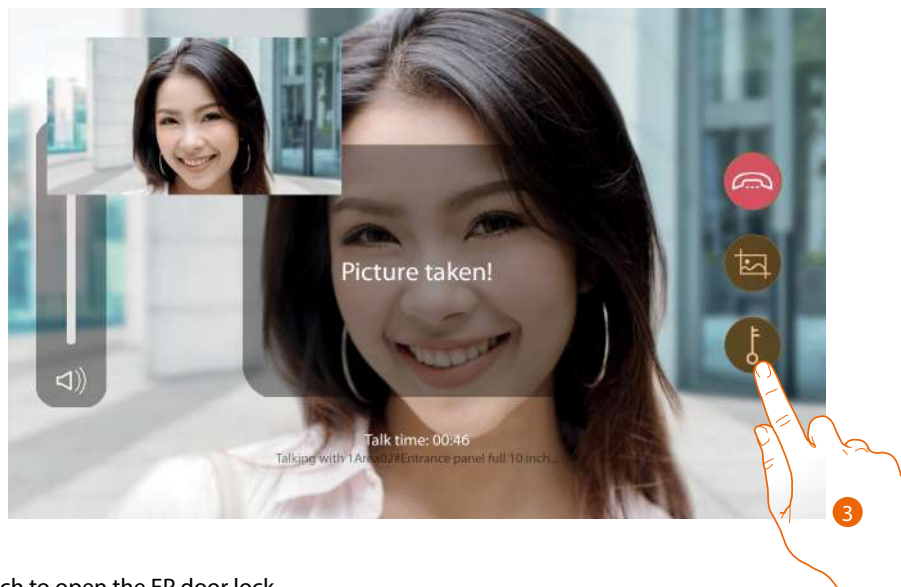

3. Touch to open the EP door lock

**Nota:** if the Lift Control function is enabled on both EP and IU, a Lift Control command is sent simultaneously with the door lock opening

If you have not answered a call and the caller recorded a message, it is possible to display it in the [messages/Voice mail](#) section.

This function must be activated in the [Function setting section](#)

A confirmation message appears

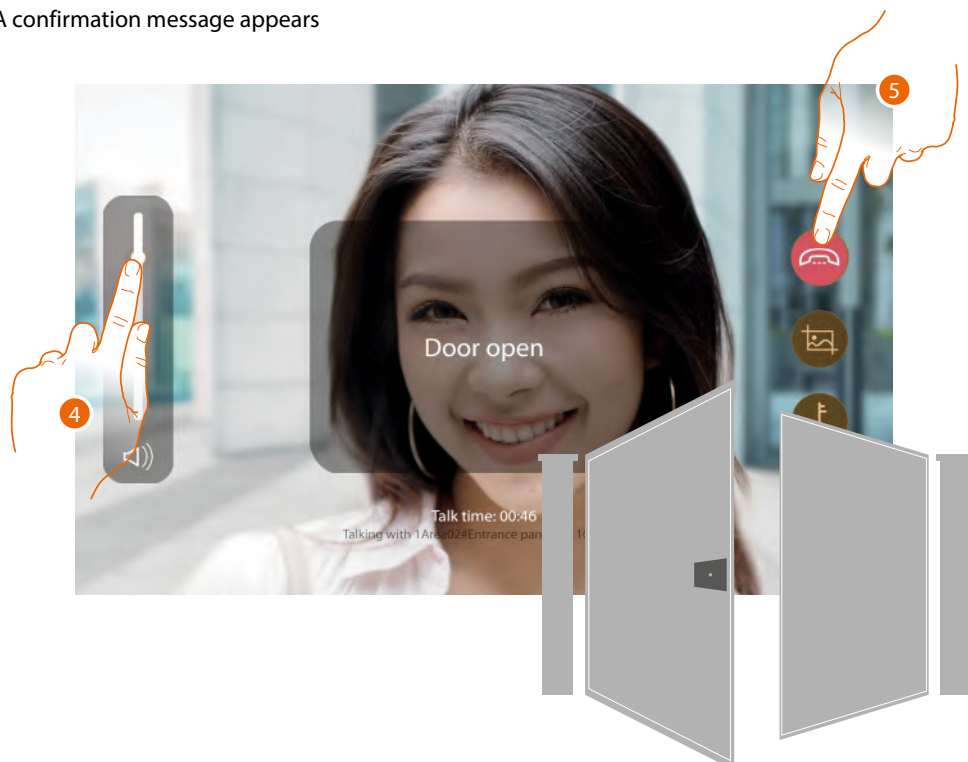

**Note:** it is possible to open the door lock even without answering the call

4. Tap to adjust the volume

5. Touch to end the call

**Note:** for security reasons, it is not possible to open a door lock without first activating the camera of the corresponding EP.

## Receive a call from IU or GS

When a call comes in, the display of the EP is activated, showing the image taken.

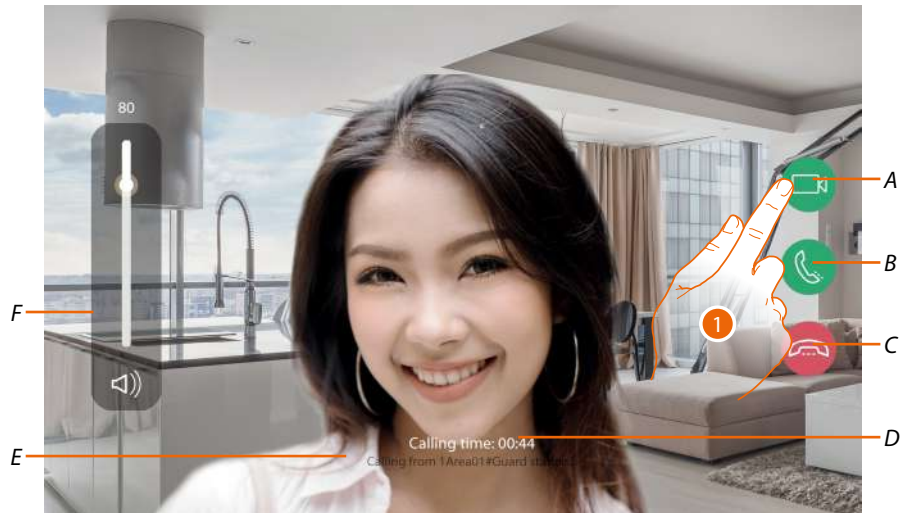

- A It answers the call by activating the camera built in the IU (only 373001 and 373002)
  - B It answers the call without activating the camera built in the IU
  - C It rejects the call or ends the communication
  - D Calling time
  - E Address of the device from which the call comes
  - F It adjusts the volume
1. Touch to answer the call

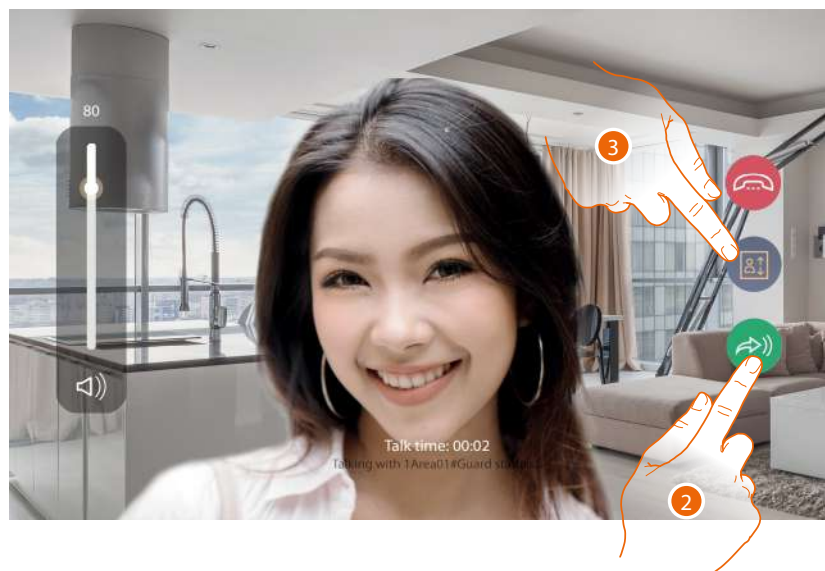

2. Touch to deactivate the camera and continue audio-only communication
3. Touch to send a Lift control request, see [Fundamental concepts](#) section

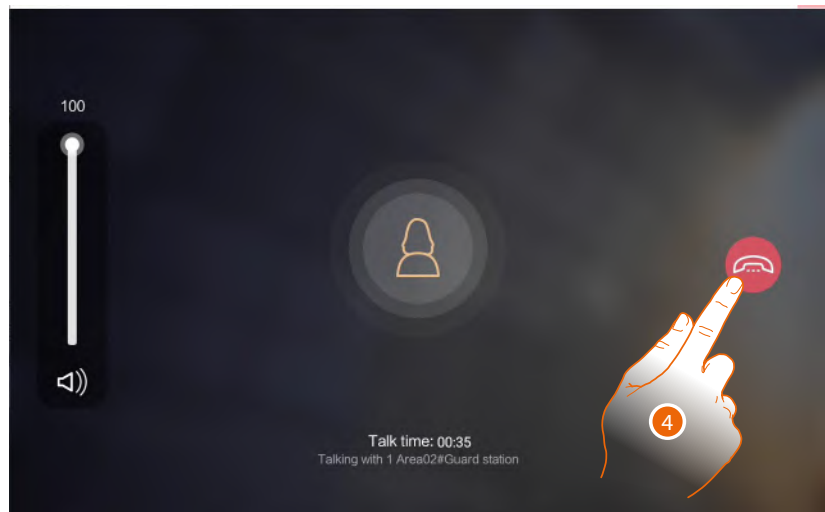

4. Touch to end



## Call IU or GS

This section can be used to communicate with other IU installed in your home, or in other apartments. It is also possible to call the GS.

It is possible to call an IU or GS in different ways:

- Call using the address in the Community;
- Call using the Alias (alphanumeric code)
- Call using the Phonebook

The call mode depends on how the community has been configured using the SW. For details see [Fundamental concepts](#)

### Call using the address in the Community



1. Enter the address in the IU or GS Community, the device helps you by showing the fields to be entered (e.g. 1 01 04 02)
2. Touch to send the call

### Call using the Alias (alphanumeric code)

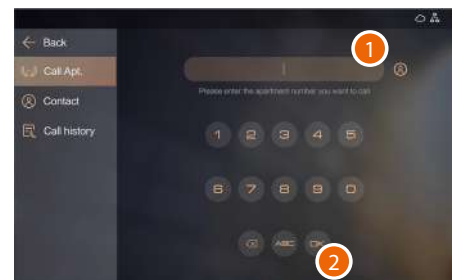

1. Enter the alias created using the SW (e.g. B12)
2. Touch to send the call

### Call using the Phonebook



1. Touch to open the phonebook where all the community contacts are present
2. Touch the code to send the call
3. Otherwise, type the contact name saved in the phonebook (e.g. JHONSMITH). The system suggests the contacts by means of the self-completion function.
4. Touch the suggested contact to send the call

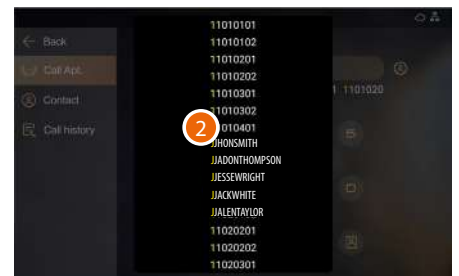

**Note:** in the call using Alias mode, the default code corresponds to the address in the Community as long as the SW has not altered it in the phonebook

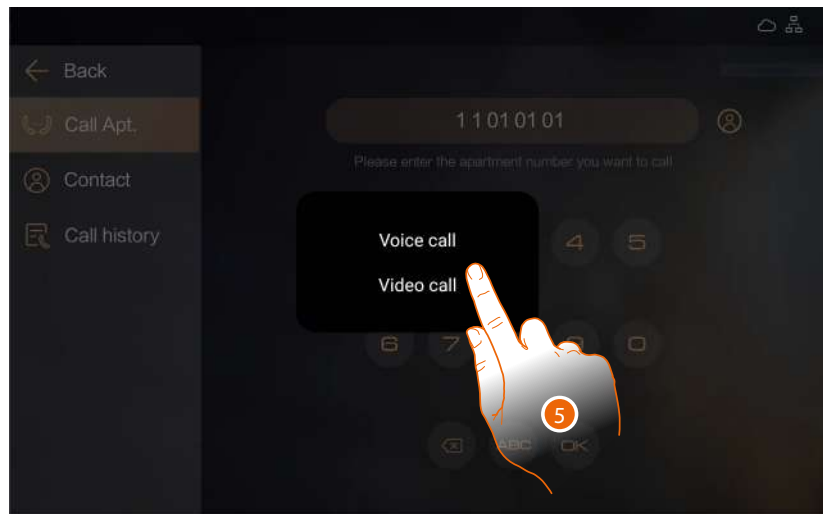

5. Touch «Voice call» to send an audio call, or «Video call» to send a video call

**Note:** the answer to the video call is active only for item 373001/02 with enabled camera.  
See [Preference/Funcion settings](#)

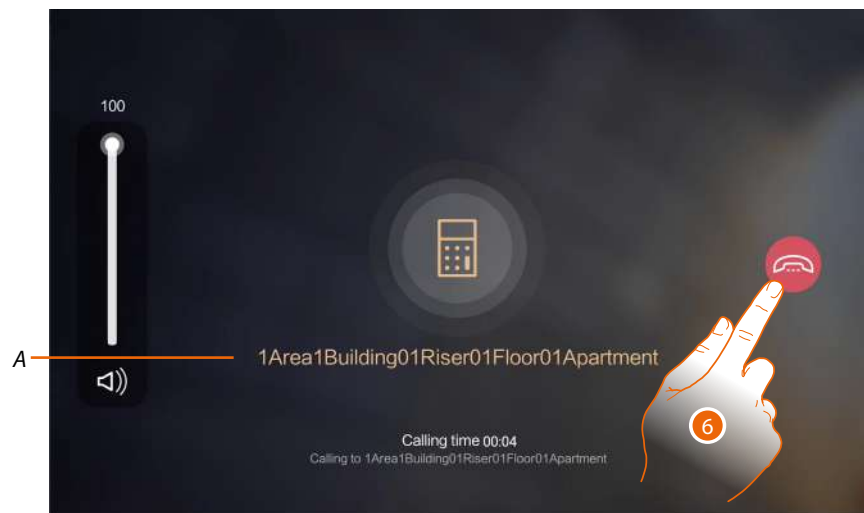

6. Wait for the person being called (A\*) to answer or touch to end the call

When the person being called answers, a picture taken by the IU appears (if this is a video call)

**Note:** the video call is active only for item 373001/02 with enabled camera.  
See [Preference/Funcion settings](#)

**\*Note:** the caller display depends on how the community has been configured using the software. For details see [Fundamental concepts](#)



7. Touch to deactivate the camera and continue audio-only communication



8. Tap to adjust the volume
9. Touch to send a Lift control request, see [Fundamental concepts](#) section

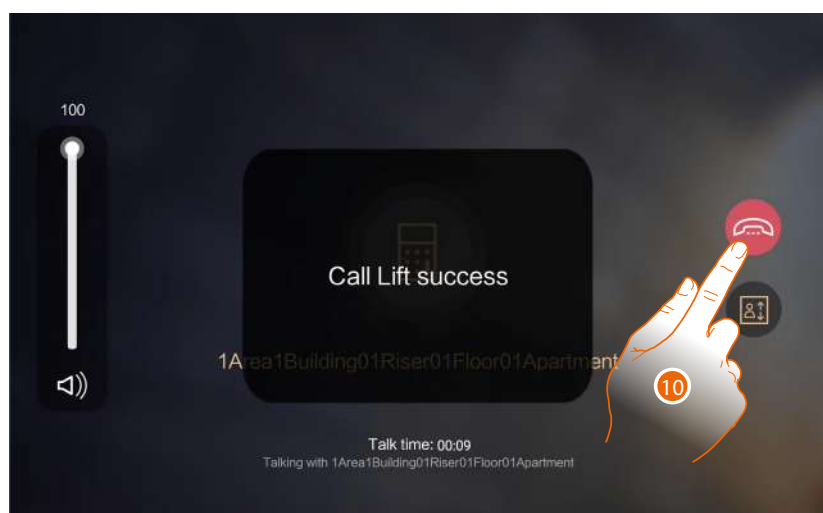

10. Touch to end

## List of personal contacts

In this section it is possible to add your Community contacts and, if necessary, add them in the favourites.

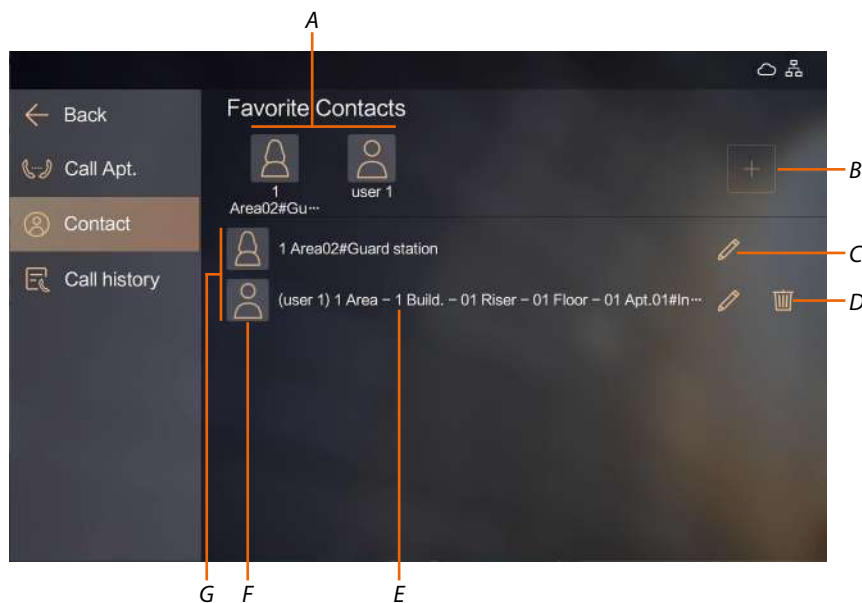

- A Favourite contacts
- B Add contact
- C Modify contact
- D Delete contact
- E Contact address
- F Type of contact
- G Contacts saved in the phonebook

## Add contact

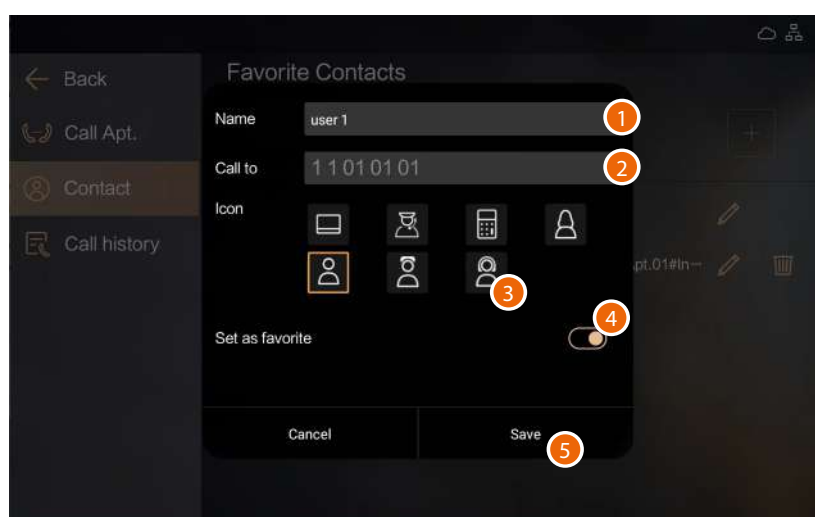

- 1 Touch to enter a contact name
- 2 Touch to enter the contact address (in the case of an address consisting of letters, type in upper case letters)
- 3 Select the contact type icon
- 4 If necessary, touch to add the contact to the favourites.
- 5 Touch to save

## Modify/delete contact

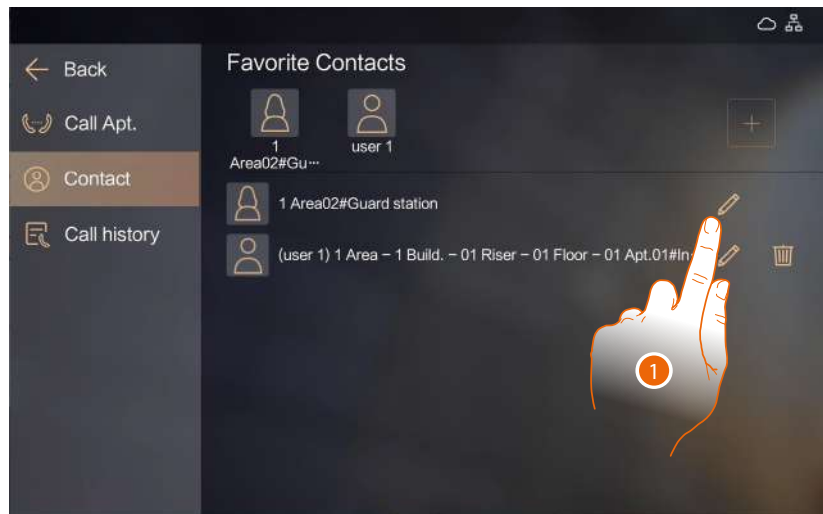

1. Touch to modify a contact

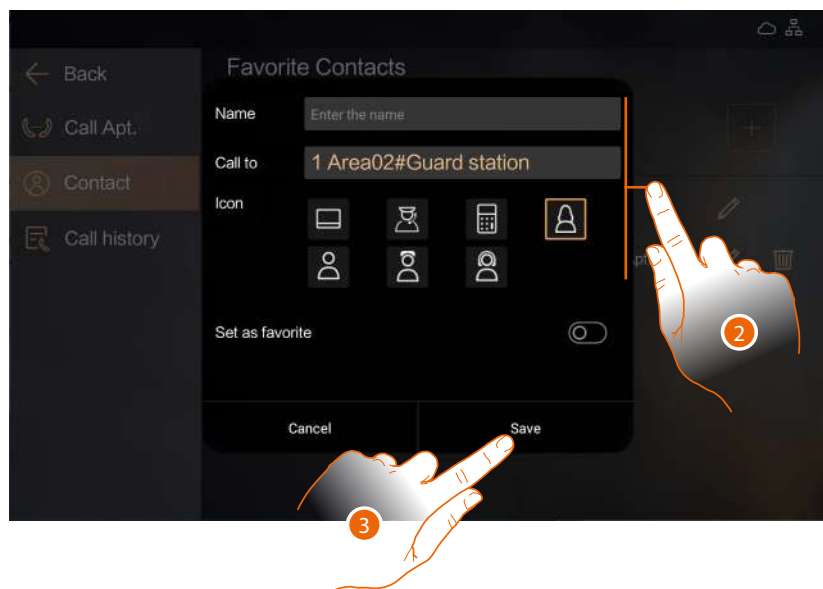

2. Touch to modify the contact data

3. Touch to confirm

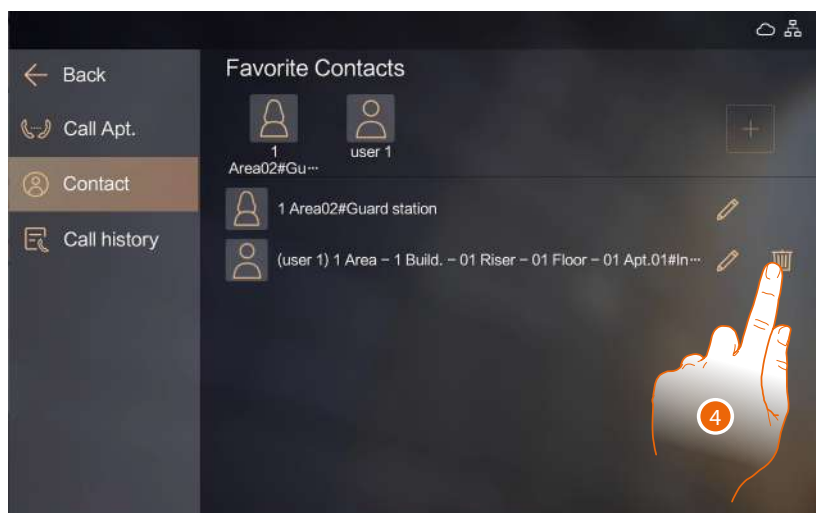

4. Touch to delete a contact

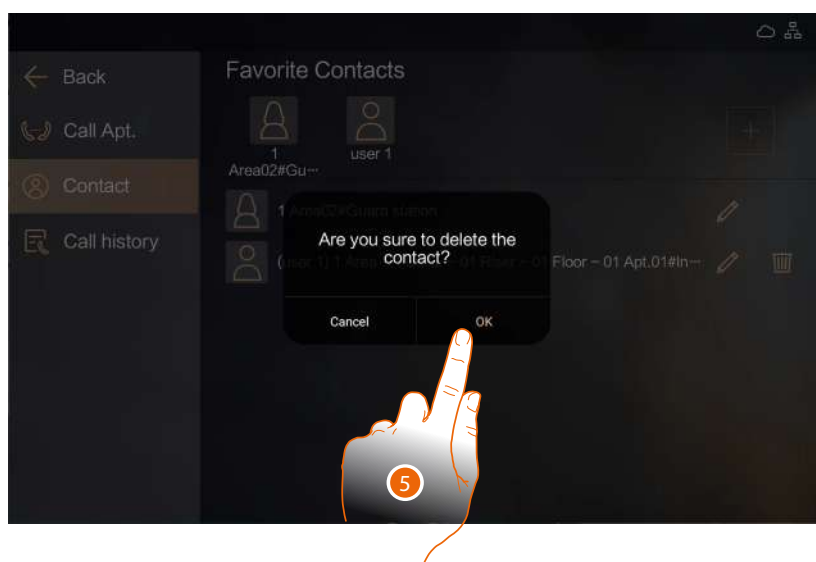

5. Touch to confirm

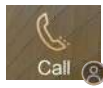

## Call IU or GS using the contact list

After creating the contacts in the [contact list](#), it is possible to call them directly.

*Note: the GS are automatically added to the list of personal contacts*

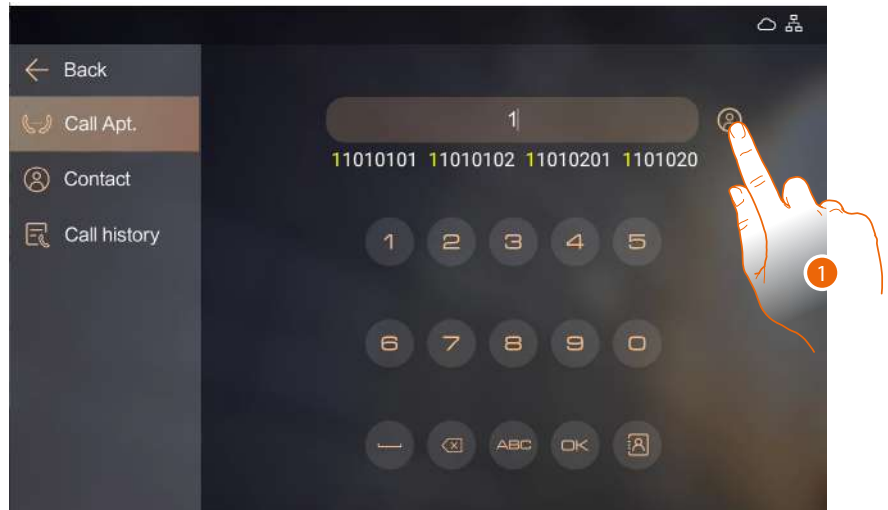

1. Touch to open the contact list

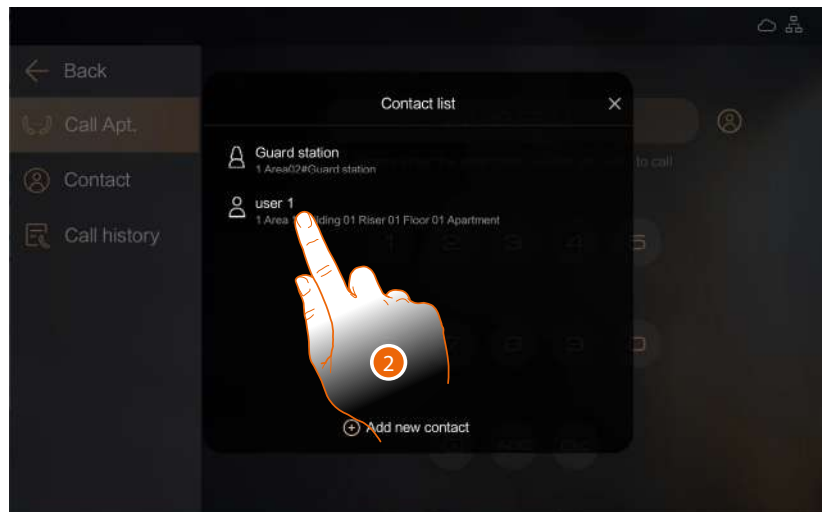

2. Touch to send the call

The call modes are the same as shown in the [Call IU or GS](#) section

## Call history

In this section it is possible to display the list of received, sent or missed calls, in chronological order.

It is also possible to display the call details

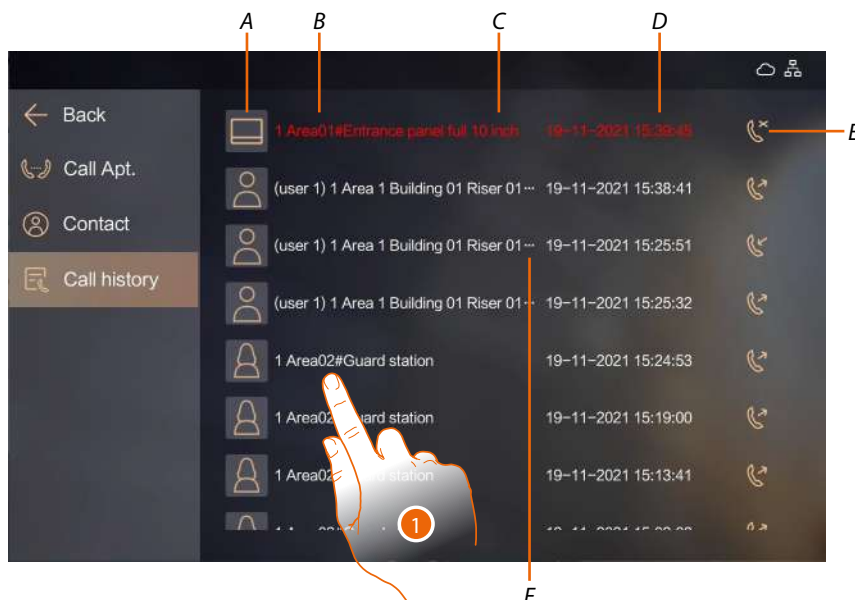

- A Type of caller
- B Caller address
- C Call to be displayed
- D Date and time of the call
- E Type of call
  - missed
  - outgoing
  - incoming

- F Call already displayed
  1. Touch to display the call details

## Entrance Panel

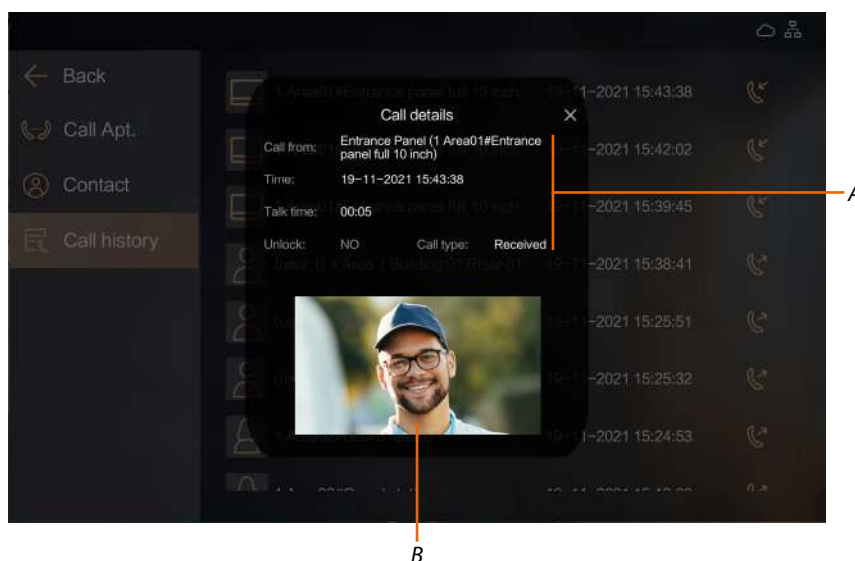

- A Call details
- B Screen shot

## Internal Unit

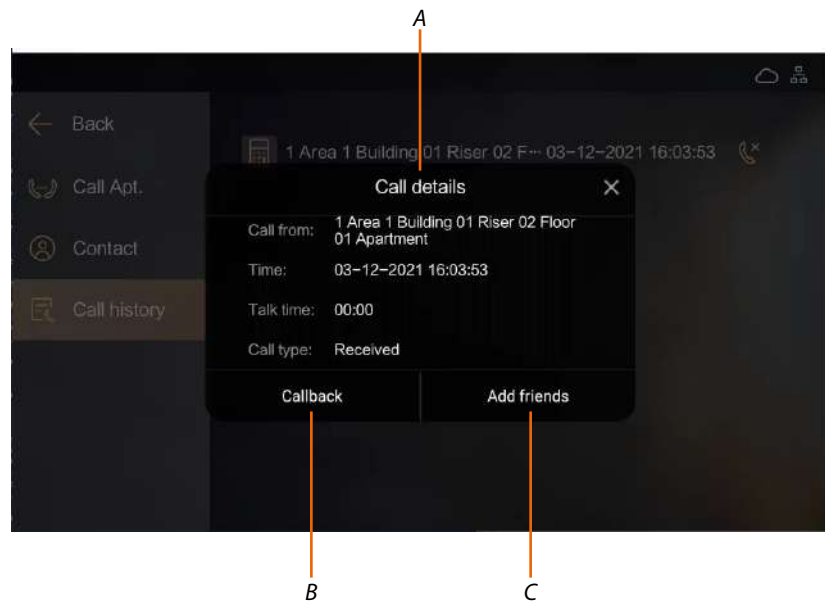

- A Call details
- B Callback
- C Add as [new contact](#)

## Guard Station

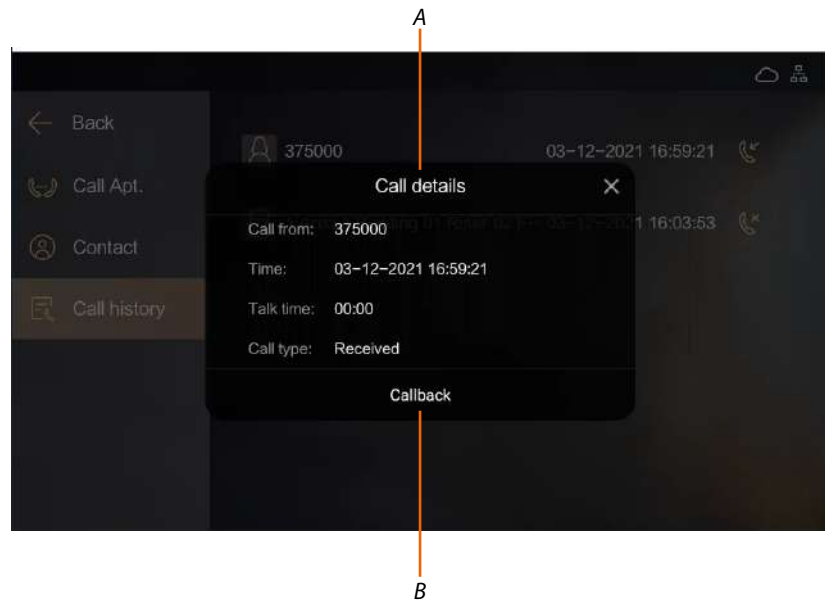

- A Call details
- B Callback



## Messages

In this section it is possible to display the messages received from the IU. The messages can contain text, images or videos.

Depending on the function, they will be displayed in different sections:

Origin	Section
Facility Manager from SW	<a href="#">Advertisement</a> , <a href="#">Community</a> , <a href="#">Emergency</a>
Family message from the IU	<a href="#">Family</a>
Video door entry answering machine of the EP	<a href="#">Voice mail</a>
Access history from the EP	<a href="#">Access history</a>

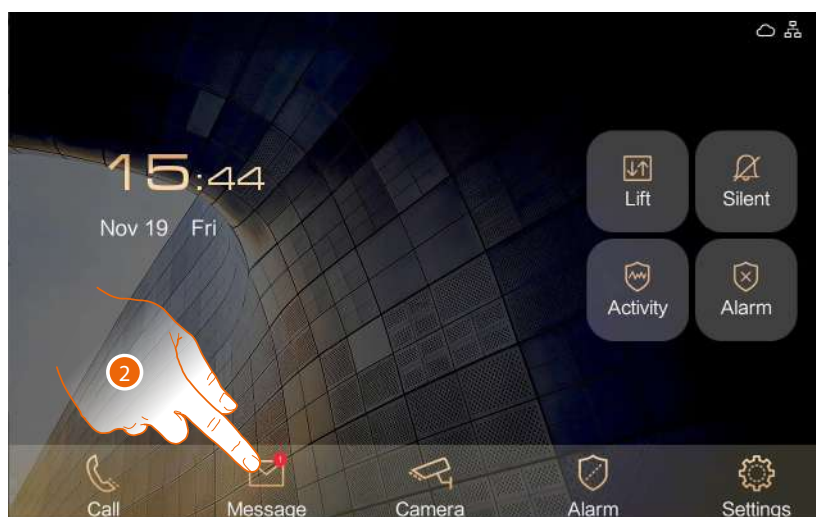

The visual notification shows the number of income and unread messages and the notification LED on the device turns on.

1. Touch to display the messages

## Advertisement

In this section it is possible to display the messages sent by the system administrator showing advertising and promotional content.

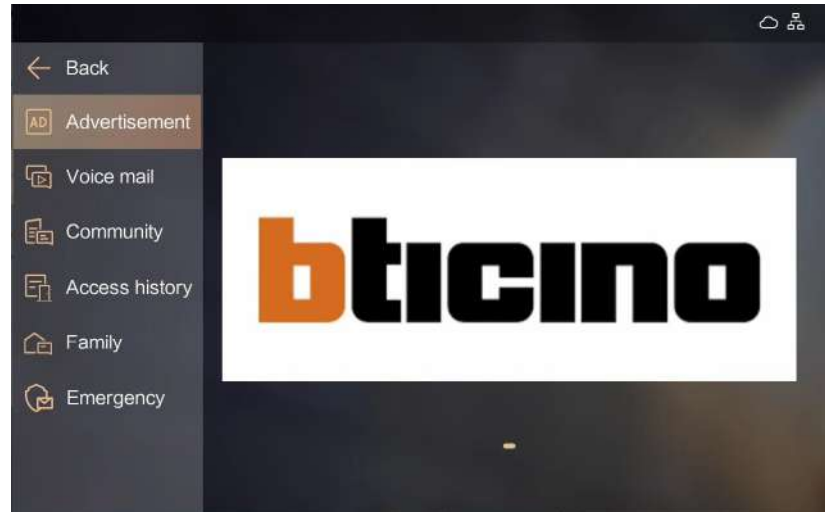

## Voice mail

In this section it is possible to display the messages left on the answering machine. If the EP does not answer a call from the IU within 30 seconds, the answering machine comes into operation and records an audio message and an image.

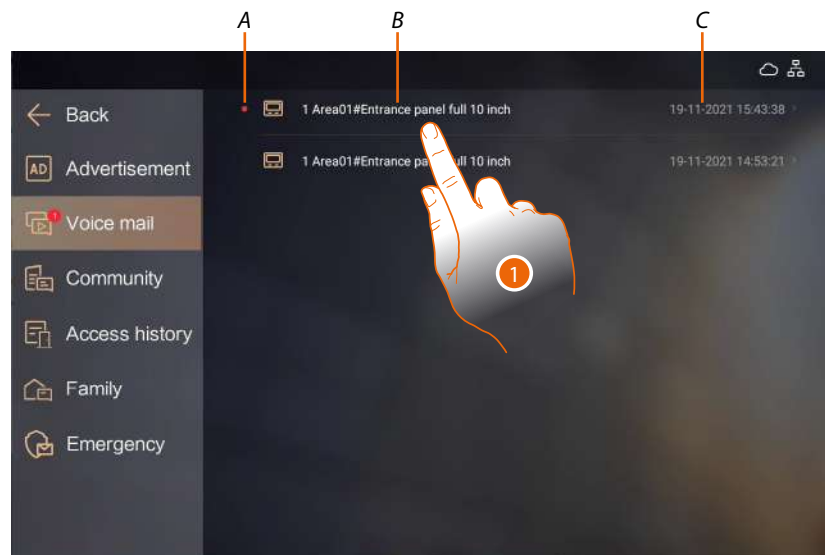

- A Not read message
- B EP address from which the message was recorded
- C Date and time of the message
- 1. Touch to display the message

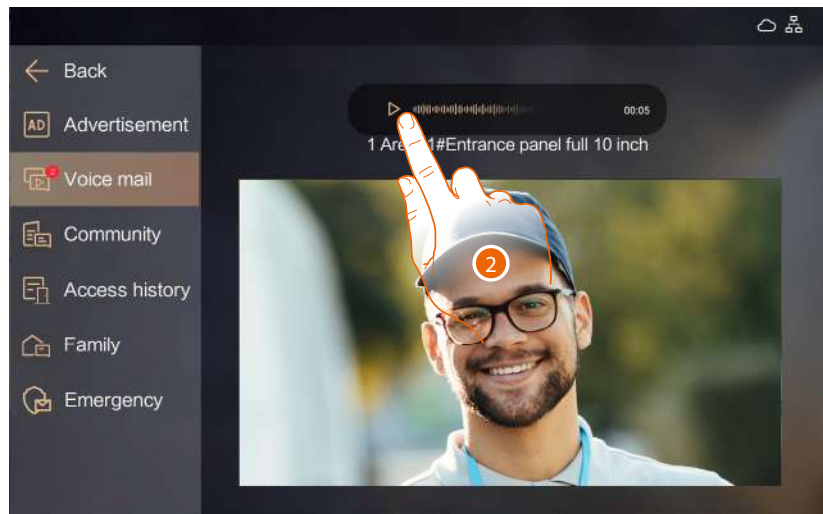

2. Touch to play the message

## **Community**

In this section it is possible to display the community messages, coming from the Facility manager.

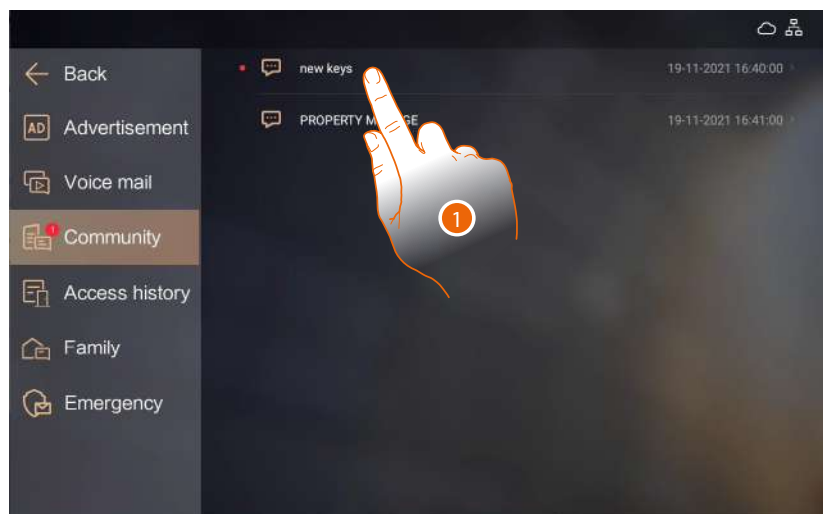

1. Touch to display the message

## Access history

In this section it is possible to display the accesses made by the EP you are responsible for (to which you have access to enter the Community)

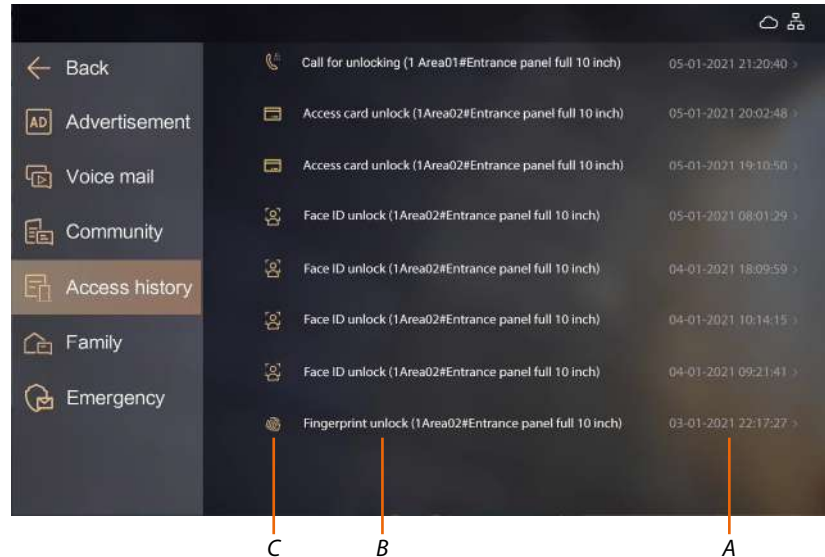

A Date and time of the access

B EP name

C Access modes

- access using card
- access using face recognition
- access using fingerprint
- access using **Personal panel access code**
- access during a call
- access during a monitoring call

## Family

In this section it is possible to listen to the messages left by other members of the house or record one yourself.



A Message to be heard

B Message duration

C Date and time of the message

D Play the message

E Delete the message

1. Touch to record a new message (max. 30)

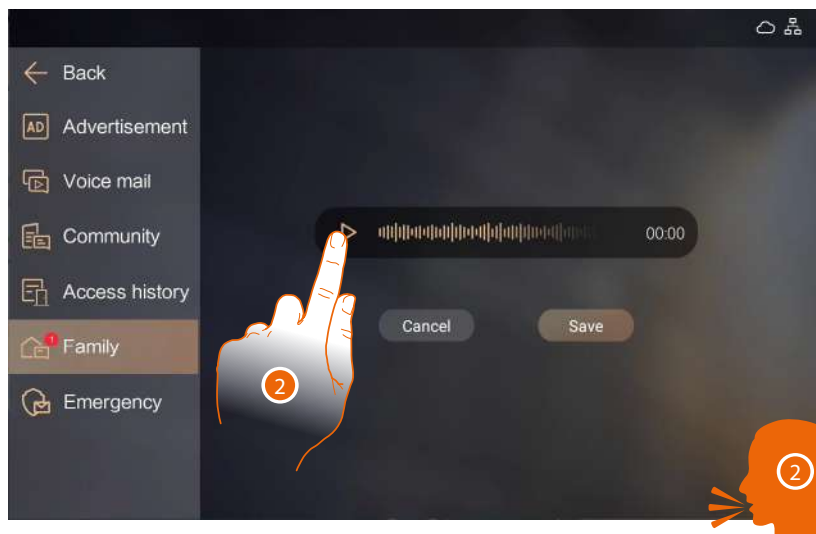

2. Touch to start recording and then record the message

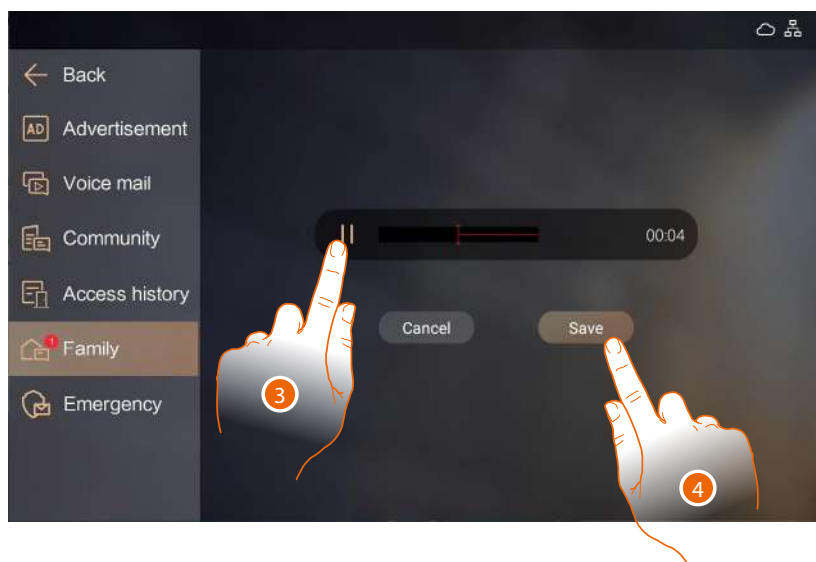

3. Touch to end

4. Touch to save the message

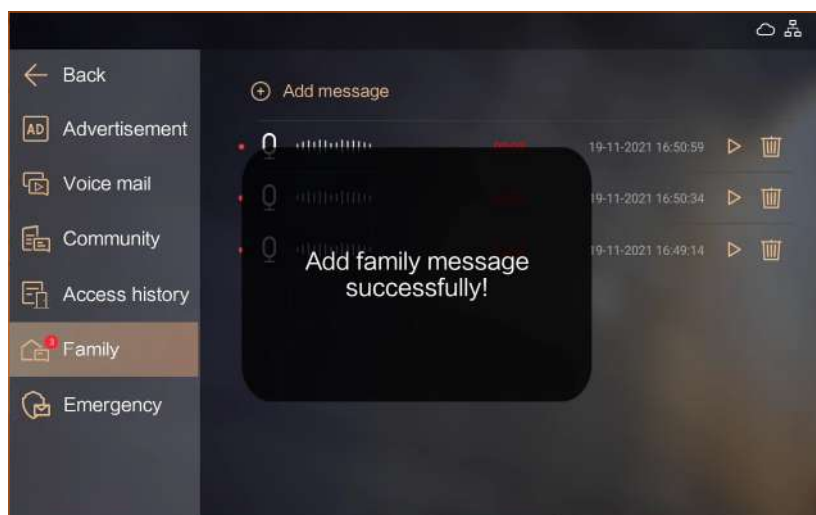

A confirmation message appears

## Emergency

In this section it is possible to display the emergency messages, coming from the Facility manager

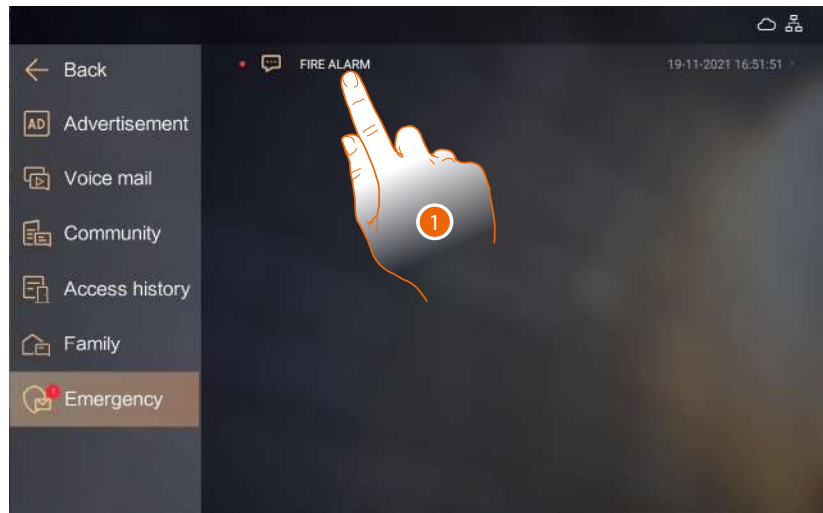

1. Touch to display the message



## Camera

In this section it is possible to directly access the EP you are responsible for (to which you have access to enter the Community) and display the CCTV (that you are responsible for)



1. Touch to display the EPs on the system
2. Touch to switch the EP on

The display shows the image taken by the EP camera.

The controls are the same as described in the [Receive a call](#) section



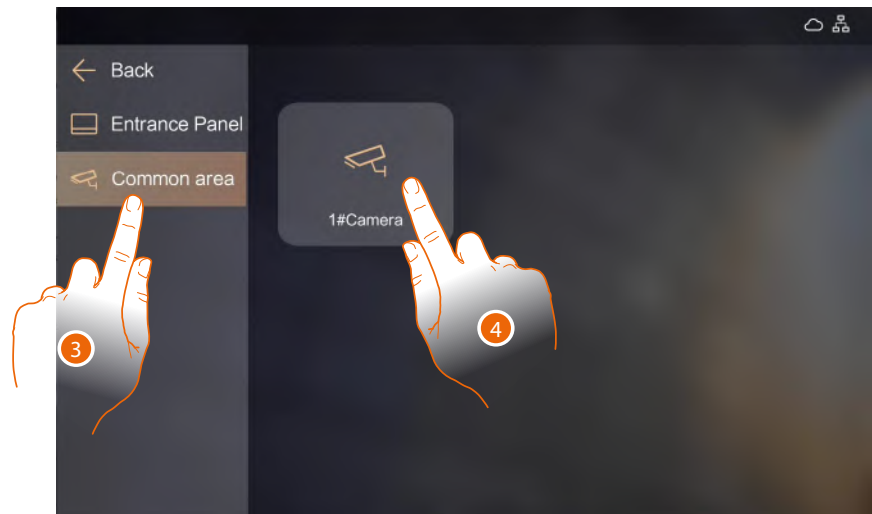

3. Touch to display the CCTV cameras on the system

**Note:** this display must be enabled in the [Function setting](#) section

4. Touch to display a camera



5. Touch to end the display



## Alarm

In this section it is possible to manage the alarm system sensors connected to the F1-F8 clamps. In particular it is possible to activate/deactivate the sensors and manage the alarm status. It is also possible to display the list of alarms detected by the sensors.

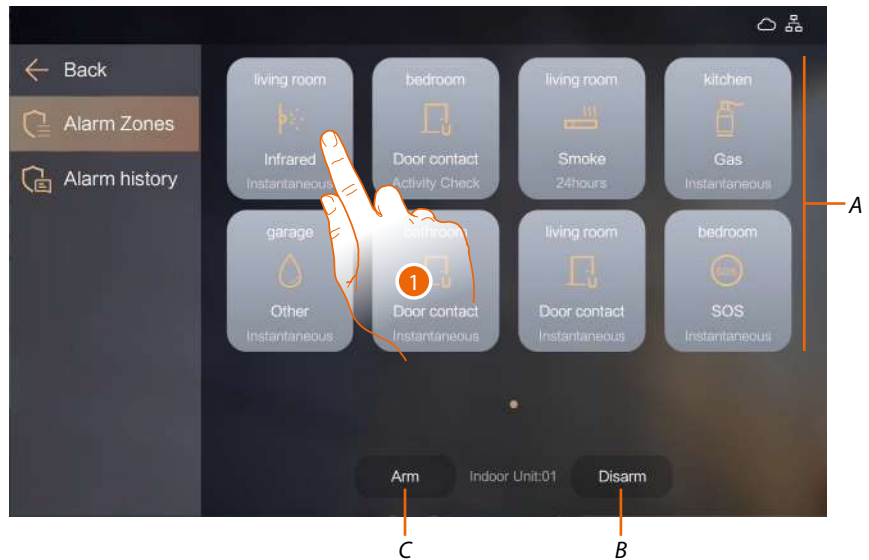

A Configured sensors

B It arms all the sensors

C It disarms all the sensors

1. Touch to manage the sensors

## Sensors

The icon that represents the sensors, shows different information on configuration and status. See [Settings\Installations\Alarm](#) section for details.

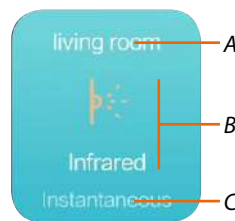

A Alarm zone name

B Type of sensor

	SOS		Smoke		Gas
	Infrared		Door contact		Others

C A Type of alarm zone

24hours	The probe is always active, even if the alarms are totally deactivated
Instantaneous	The alarm is immediately communicated
Delay	The alarm is given at a certain time after the triggering condition occurs
Activity check	The alarm is communicated immediately, if the sensor does not detect activities for a preset time
Scheduled	Scheduled activation

## Sensor status

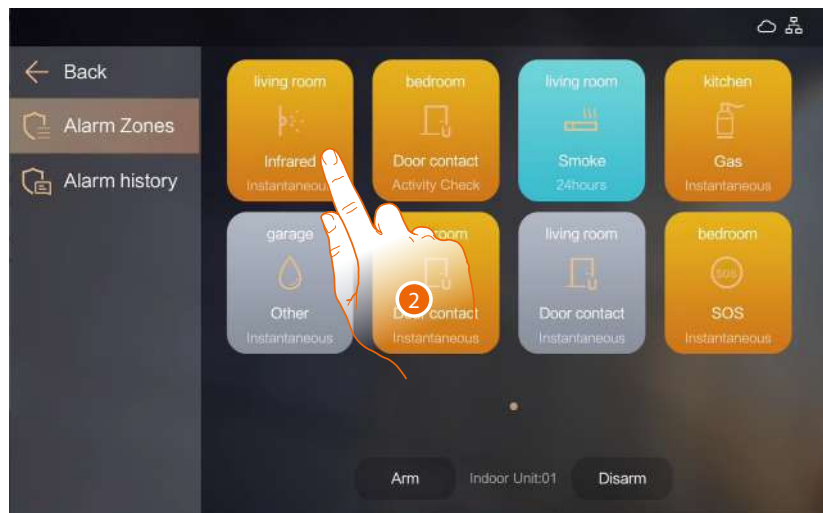
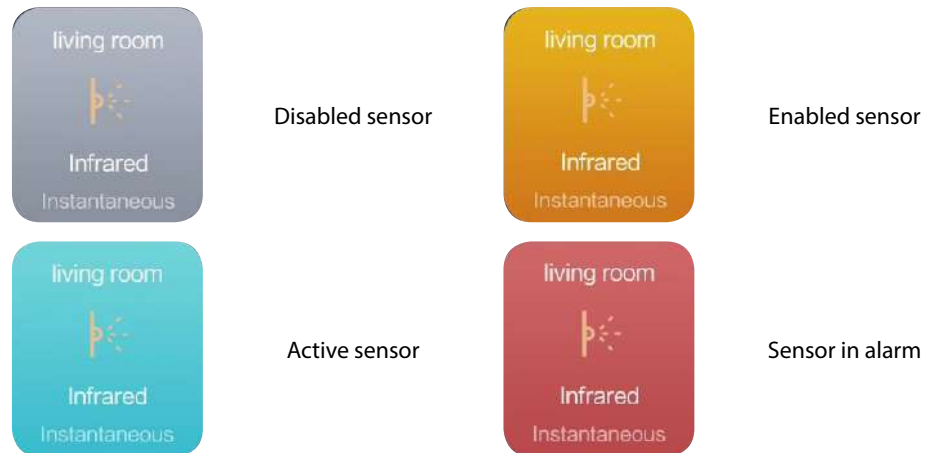

2. Touch to activate the sensor

**Note:** to activate the sensor you must first enable it in the [Settings\Installations\Alarm](#) section

**Note:** the sensors with «24hours» activation time are always active



A message confirms the sensor activation

A pop-up appears following an alarm, the IU emits an audible warning and the signal LED on the device flashes

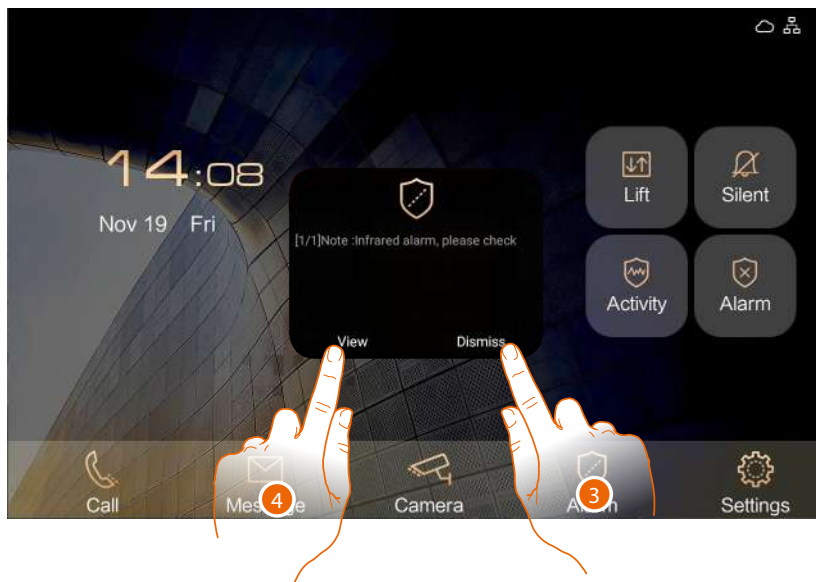

3. Touch to close the pop-up (the alarm is not silenced)  
or
4. Touch to open the alarms section to manage the alarm

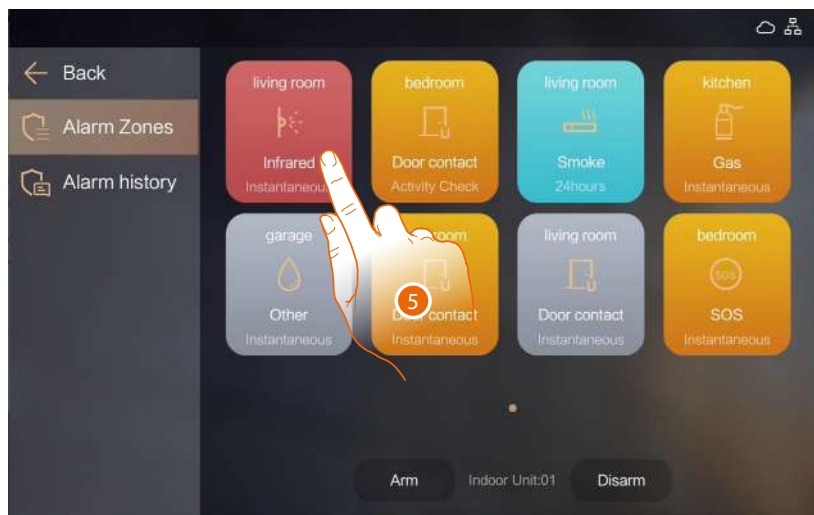

5. Touch to manage the alarm

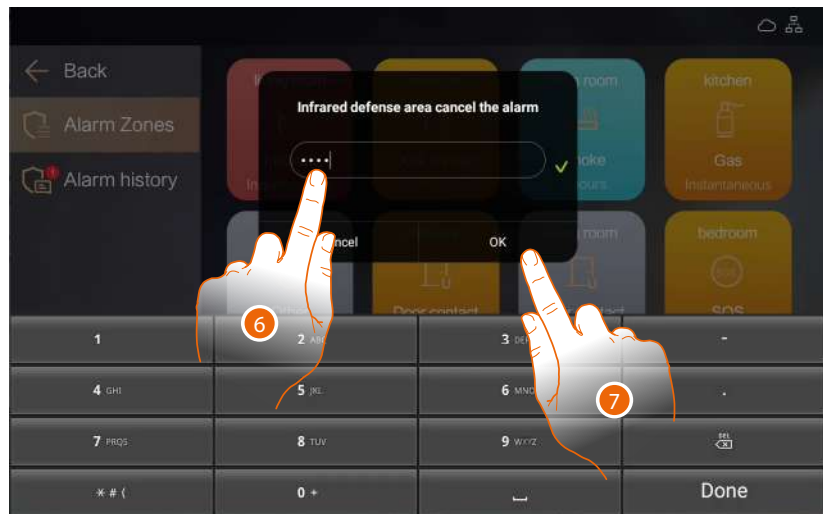

6. Enter the password to silence the alarm (default 2000)
7. Touch to confirm

A message indicates that the operation has been carried out

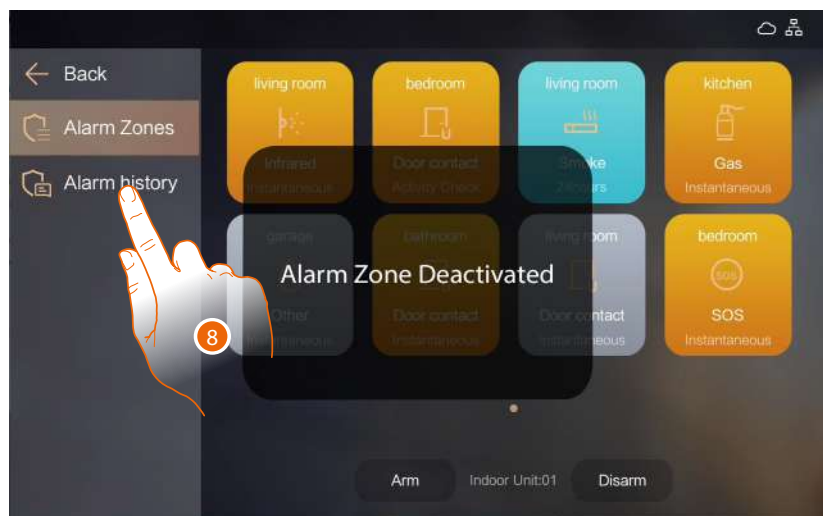

8. Touch to display the alarm data

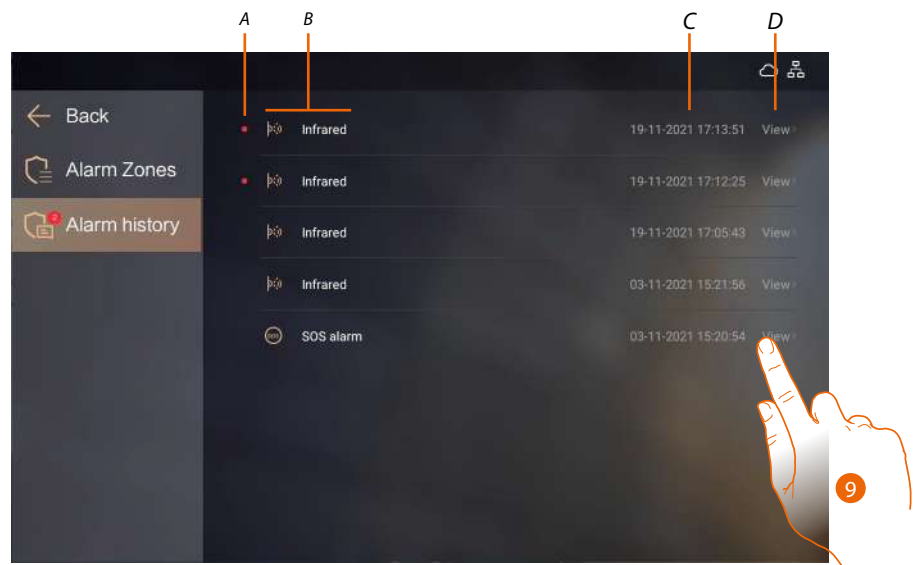

- A Alarm to be displayed
  - B Type of probe
  - C Date and time of the alarm
  - D See details
9. Touch to view

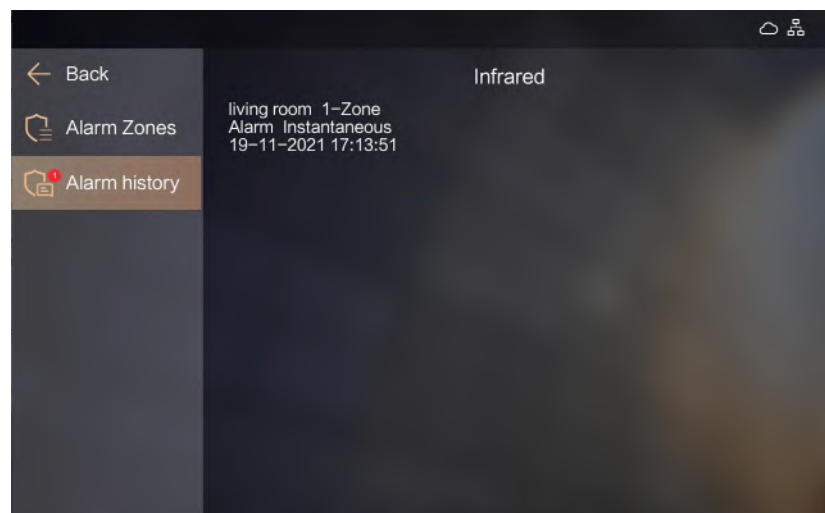



## User settings

In this section it is possible to perform a wide range of customisations that will enable you to make the most of your IU.

There are further configurations in the Installation section (installer access), accessed by means of an unlock code.

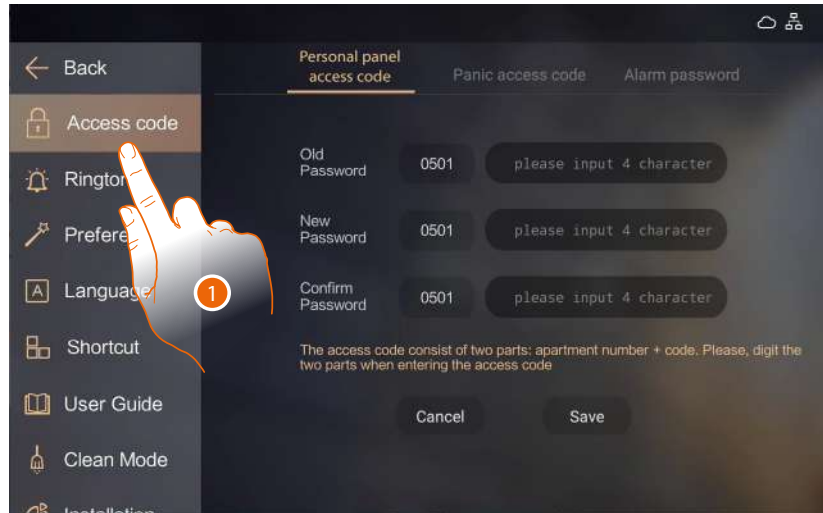

1. Touch the icon for the desired customisation, choosing among:

Access code	It sets different types of password and access codes
Ringtone	It sets the ringtones for the incoming calls
Preferences	It sets the parameters of the display and some functions
Language	It sets the interface language
Shortcut	It manages the display of some functions in the Home Page
User Guide	It displays the QR code to access the documentation
Clean Mode	It activates the «Screen cleaning» function
Installation	It sets the advanced parameters ( <b>It sets the advanced parameters</b> )

## Access code

In this section it is possible to set different types of code

Personal access code	Set the code which opens the last EP of my community, i.e. the EP closest to the apartment, chosen from those to which I have access (default 4321*). Example: if they are enabled for all the accesses (complete Area/ Building/Riser/Floor/Apartment structure) set the code which opens the Apartment EP.
Panic access code	It sets the emergency code (default 4321*) that opens the door and at the same time sends an alarm message to the GS. Example: if a criminal forces me to forcibly open the door**.
Alarm password	It sets the code to silence the alarm (default 2000*.)

**\*Note:** for safety reasons, modify the code.

**\*\*Note:** to activate the code, there must be a resident associated with the apartment in the SW (see the SW Community /Person profile management manual).



1. Enter the old code
2. Enter the new code
3. Enter the new code again
4. Touch to confirm

If the procedure has been completed correctly, a confirmation message will appear.

**Note:** for the Entrance Panel and Panic codes, the code consists of a fixed part (A) with the apartment address and of a customisable part (B).

## Ringtone

In this section it is possible to set the ringtone parameters for the incoming calls, based on the origin.

- Apartment entrance panel
- Entrance panel
- Indoor unit
- Guard station

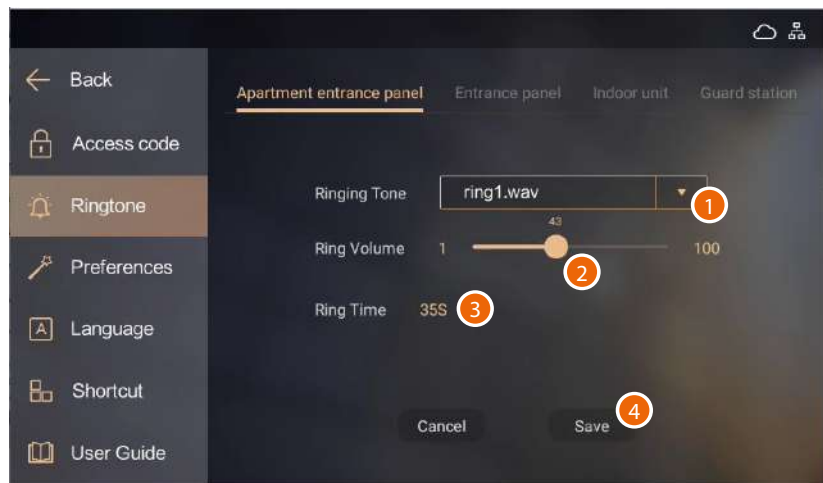

1. Select the tone
2. Scroll to modify the volume
3. Display the ringtone duration time
4. Touch to confirm

**Note:** the volume adjustment is the same for all sources.

If the procedure has been completed correctly, a confirmation message will appear.

## Preference

In this section it is possible to modify some display parameters, enable the device camera and the key sound.

### Display parameters

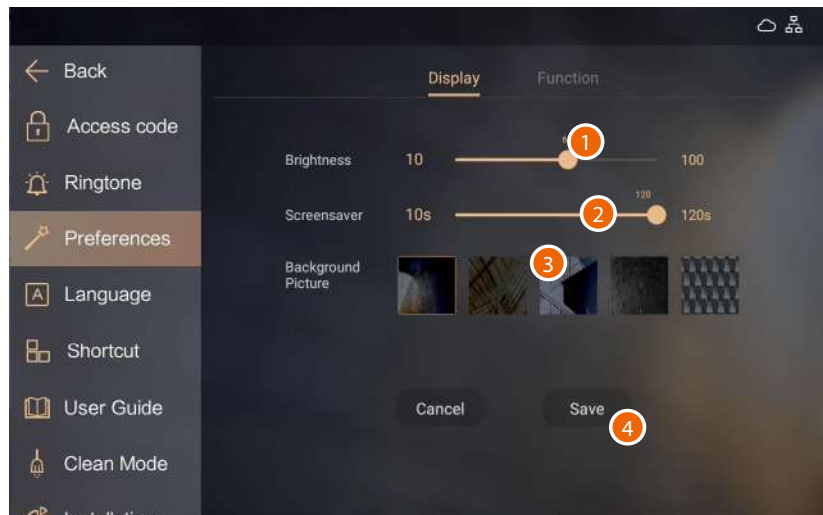

1. Touch to modify the display brightness
2. Scroll to set the screen saver activation time
3. Select the display background
4. Touch to confirm

### Function setting

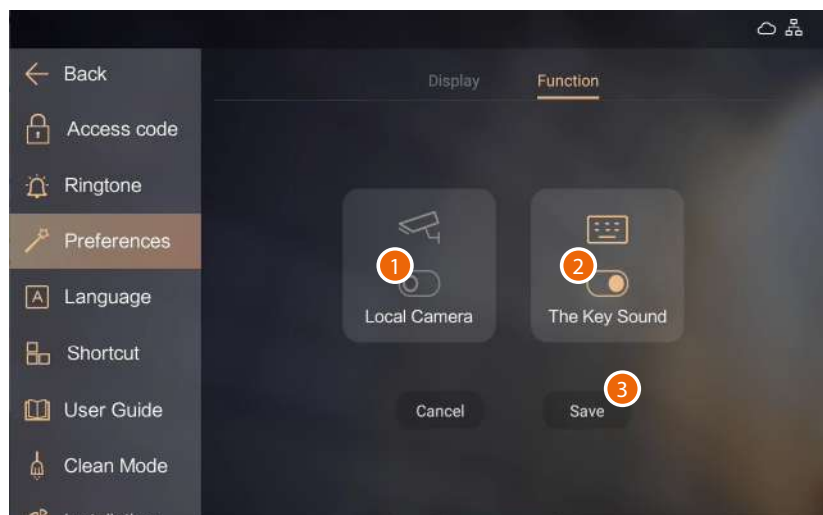

1. Touch to enable the device camera (only for 373001/02)
2. Touch to enable the sound when touching the virtual keypad keys
3. Touch to confirm

## Language

In this section it is possible to set the interface language



1. Touch to select the language among the ones available

## Shortcut

In this section it is possible to define which functions to display in the Home Page and to set up some parameters

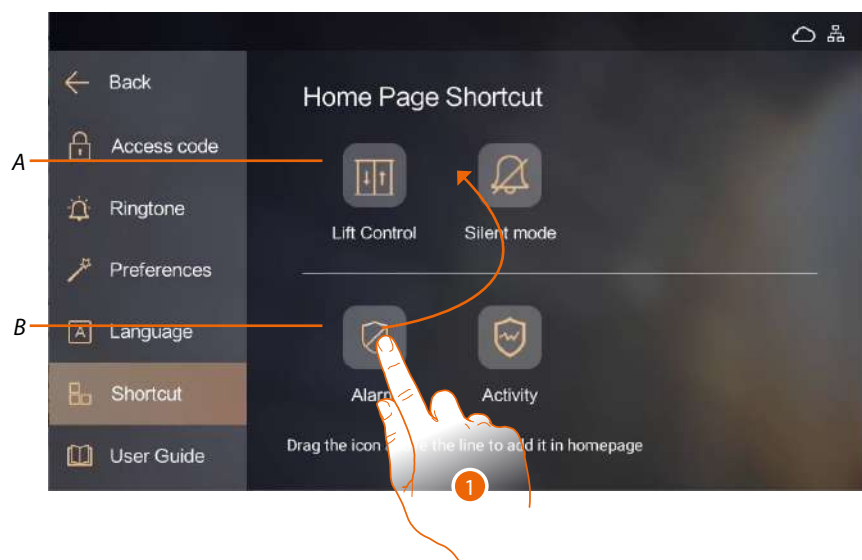

A Function in the home page

B Available function

1. Touch the icon (keep pressed) and drag it to the upper area to display it on the home page

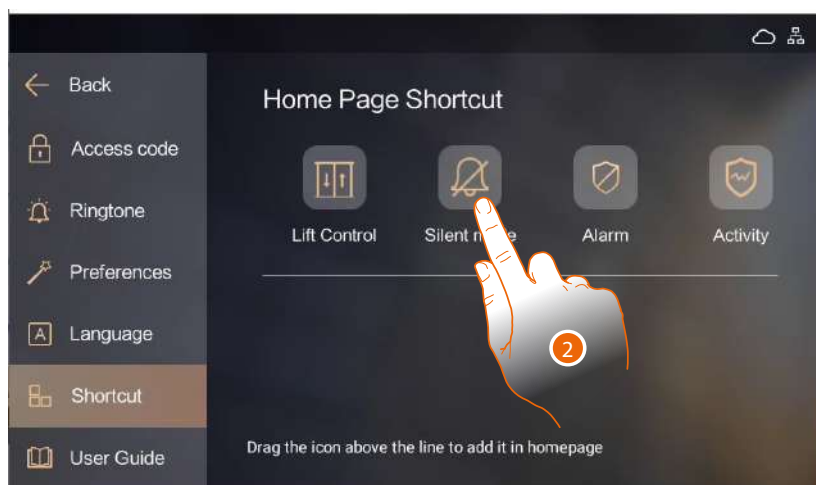

2. Touch to set the function

## Silent mode (scheduled silencing) settings

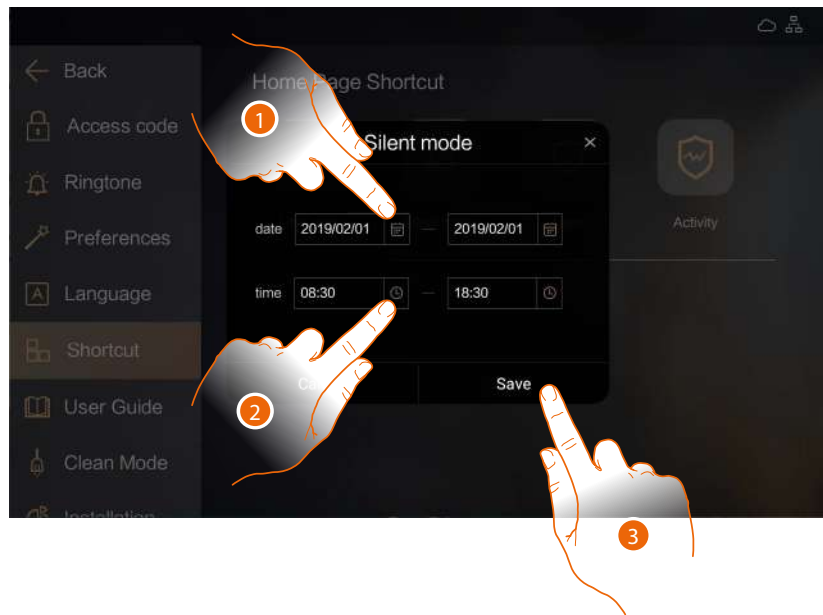

1. Touch to select the start and end date to set the ringtone silencing period
2. Touch to select the start and end hour to set the ringtone silencing period
3. Touch to save the setting

## User guide

In this section it is possible to download this manual using the QR code.

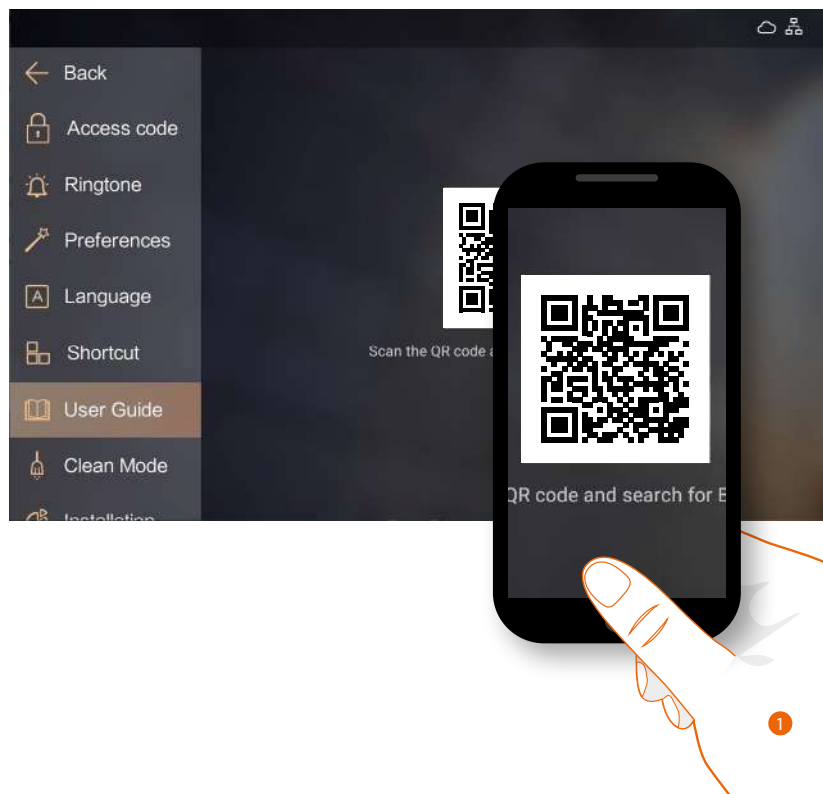

1. Using a smartphone, scan the QR Code  
Inside the site, search for the 373001/02/03/04 codes and download the manual

## Clean Mode

In this section it is possible to disable the display for cleaning purposes, without the risk of sending unwanted commands.

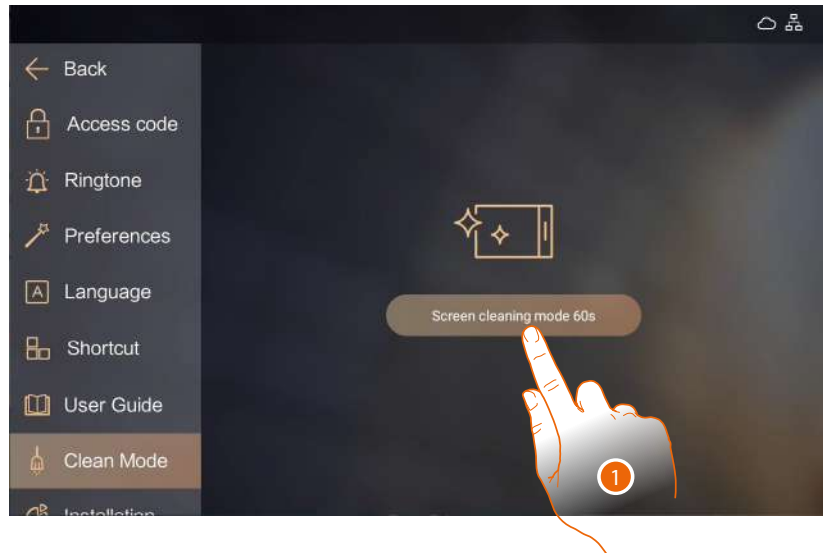

1. Touch to disable the monitor

After disabling, the display remains in stand-by for 60 seconds.

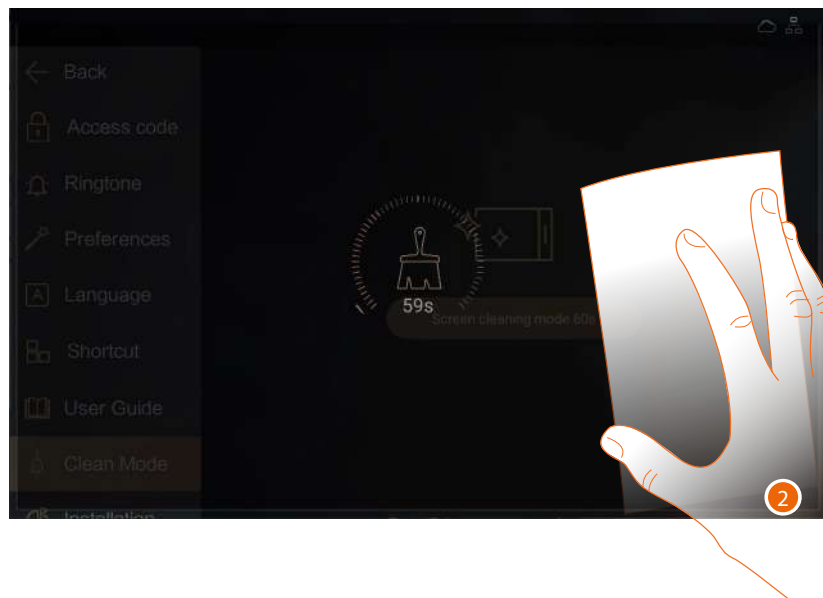

2. During this period, it is possible to clean the monitor

**Note:** do not clean with solvents, thinners etc. or abrasive products. Only use a soft cloth.

## Advanced settings (Installation)

In this section it is possible to set different parameters such as codes, passwords, ringtones, display parameters, language and others.

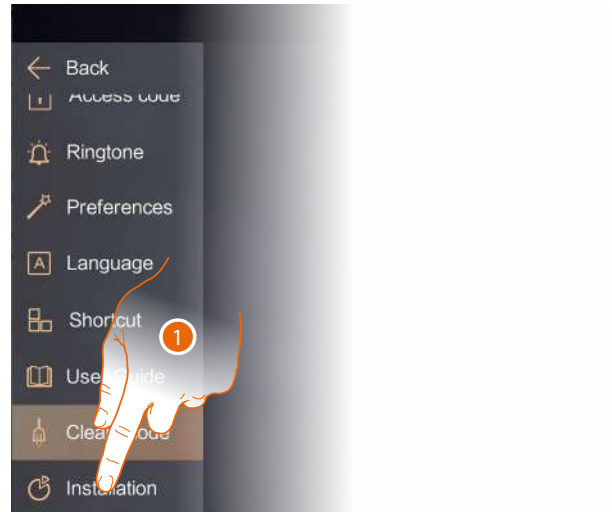

1. Touch to modify the advanced settings.

**Warning:** access to the Advanced Settings should only be attempted by experienced people, as wrong actions could compromise the operation of the device

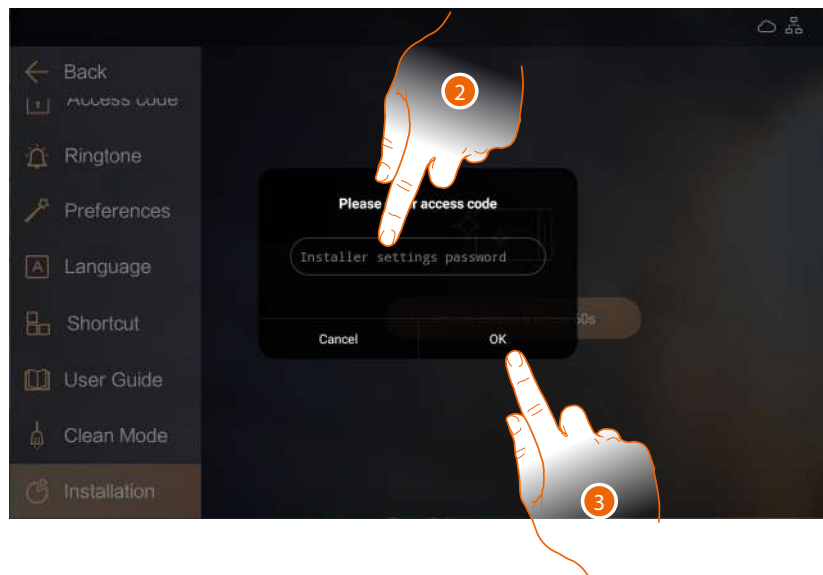

2. Enter the access code (default 1111)
3. Touch to confirm

**Note:** it is not possible to enter this section if there are active alarms

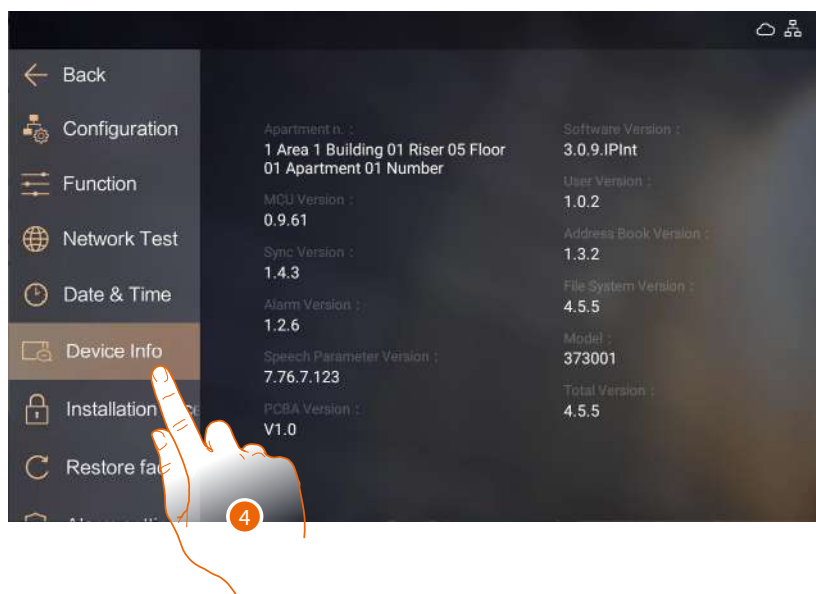

4. Touch the icon for the desired customisation, choosing among:

Configuration	It sets the Local Address in Demo mode
Function	It enables the <b>display of some functions</b> on the home page and in other menus
Network Test	It makes <b>test calls</b> to test the system
Date & Time	It sets <b>date e time</b>
Device Info	It displays <b>the address in the Community</b>
Installation	It sets the <b>installer password</b>
Restore factory	It restores the <b>factory values</b> of the device
Alarm setting	It displays and <b>sets the Alarm system probes</b>

## Function setting

In this section it is possible to enable the display of some functions on the home page and in other menus.

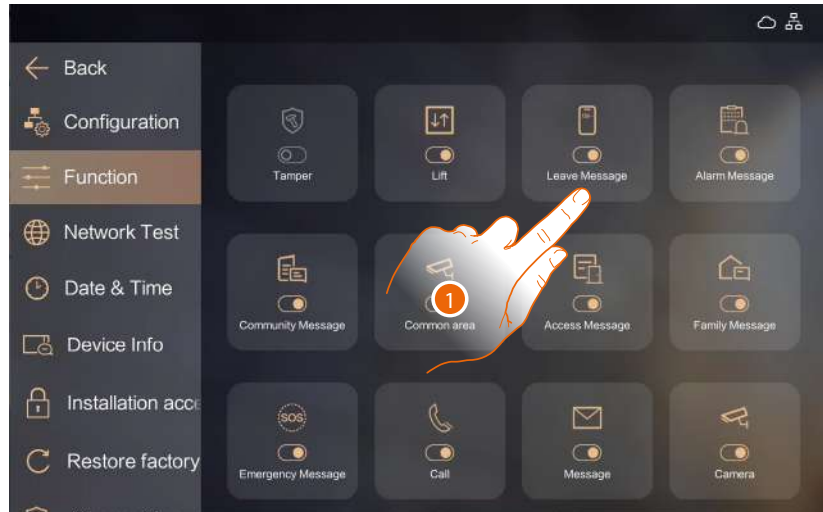

1. Touch to enable the function display as shown in the following table:









### Message section

	It enables the display of the <b>Access history</b> function		It enables the display of the <b>Voice mail</b> function
	It enables the display of the <b>Family</b> function		It enables the display of the <b>Community</b> function
	It enables the display of the <b>Emergency</b> function		

The Emergency notification message will arrive even if the message function is disabled.

### Home page

	It enables the display of the Call function		It enables the display of the Alarm function
	It enables the display of the Message function		It enables the display of the Lift function
	It enables the display of the Camera function		It enables the display of the Settings function

## Camera section

---



It enables the display of the **Common area** function

---

## Alarm section

---



It enables the display of the **Alarm history** function

---

## Call section

---

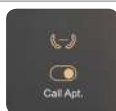

It enables the display of the **Call apt.** function

---

## Device section

---

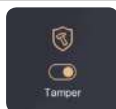

It enables Tamper input

---

## Network test

In this section it is possible to make a **test call** and test the **data network**

### Call test

This function performs call tests between devices configured in the AB.

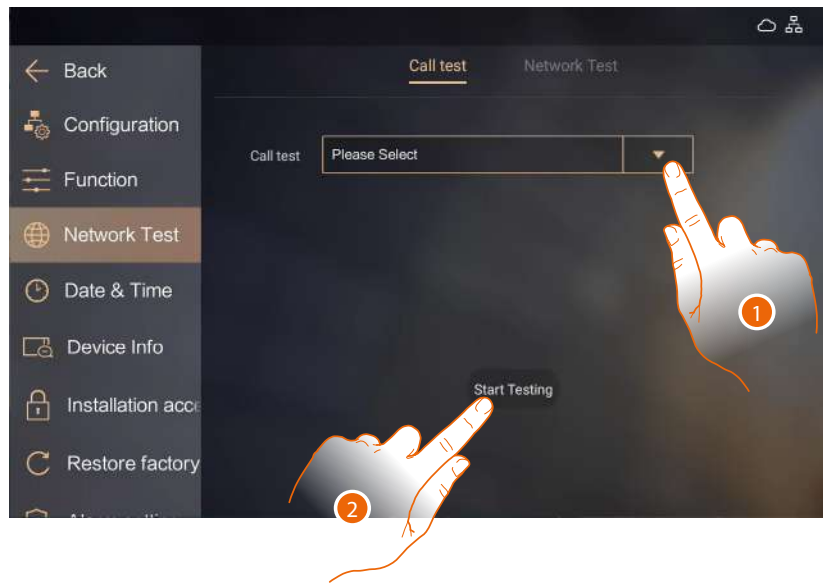

1. Select the device to make the test call.
2. Touch to start the test



If the communication is activated, the test has passed

## Network test

This function performs call tests of devices whose IP address is known

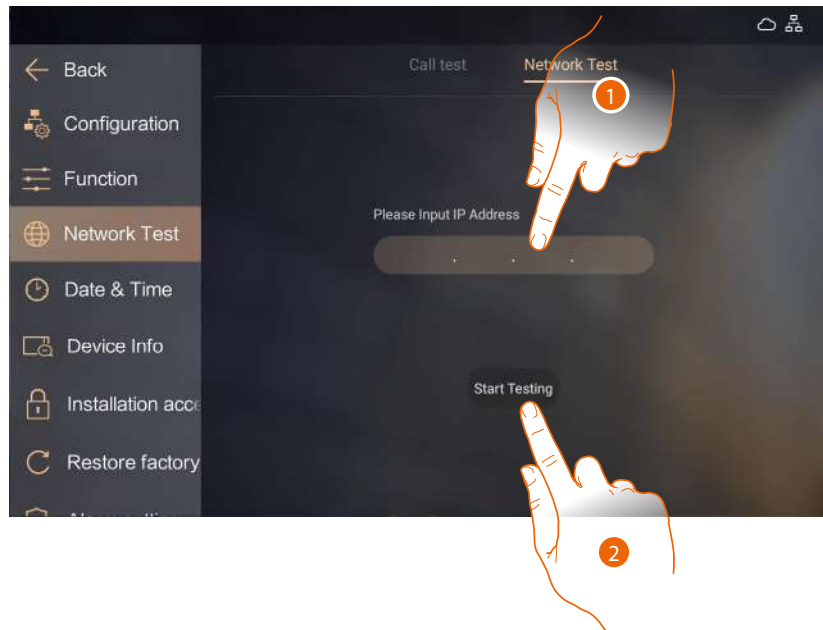

1. Enter the IP address of the device to test the connection
2. Touch to start the test

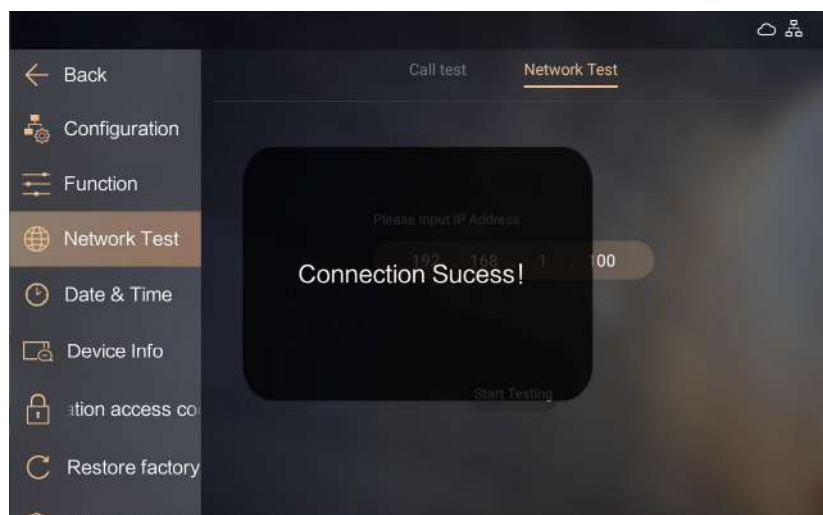

If the test is successful, a confirmation message appears

## Date & Time

As default all the devices on the system have date and time aligned with those of the Server DES. However, it is possible to set the date and time of the single device in this section.

**Note:** you can change the date&time only temporarily.

During the night the server will realign date&time to the system datas.

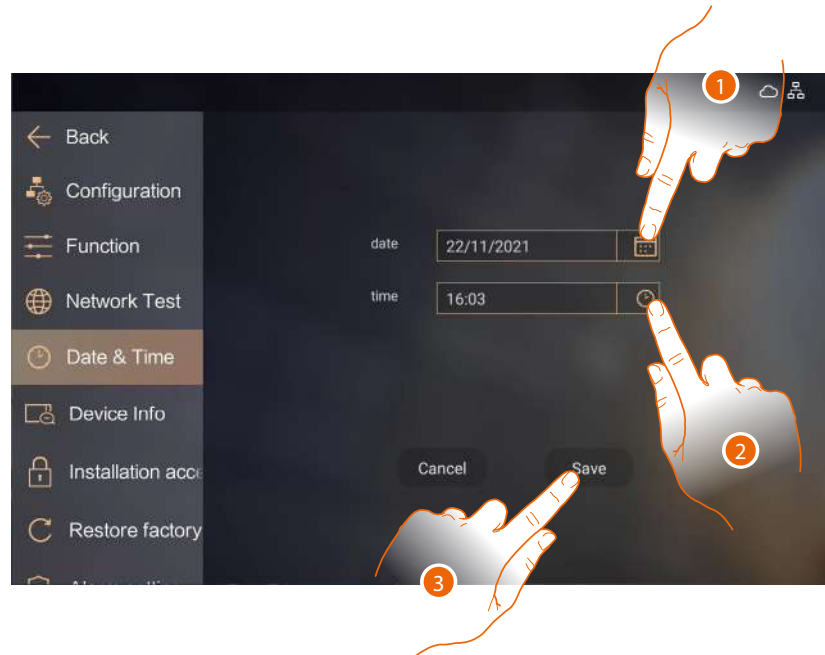

1. Touch to set the date
2. Touch to set the time
3. Touch to save

## Device in formation

In this section it is possible to display different device parameters

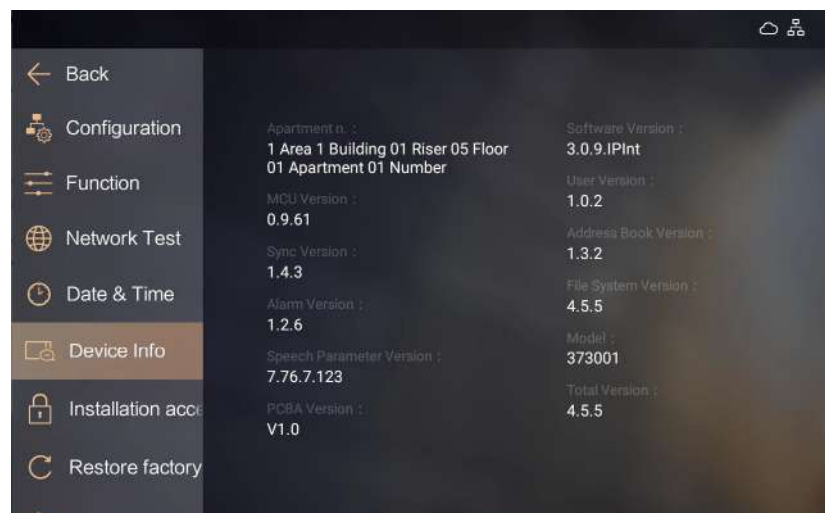

## Installation access code

In this section it is possible to modify the installer password (default 1111)

*\*Note: for safety reasons, modify the code*

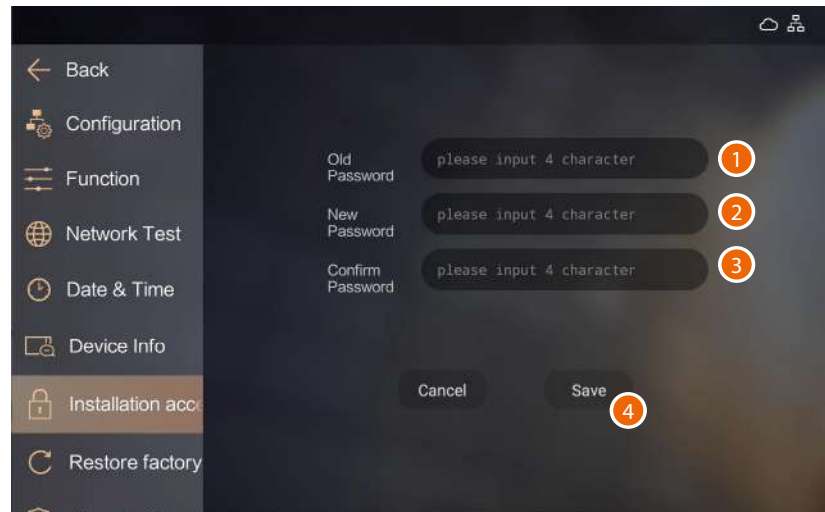

1. Enter the old password
2. Enter the new password
3. Enter the new password again
4. Touch to confirm

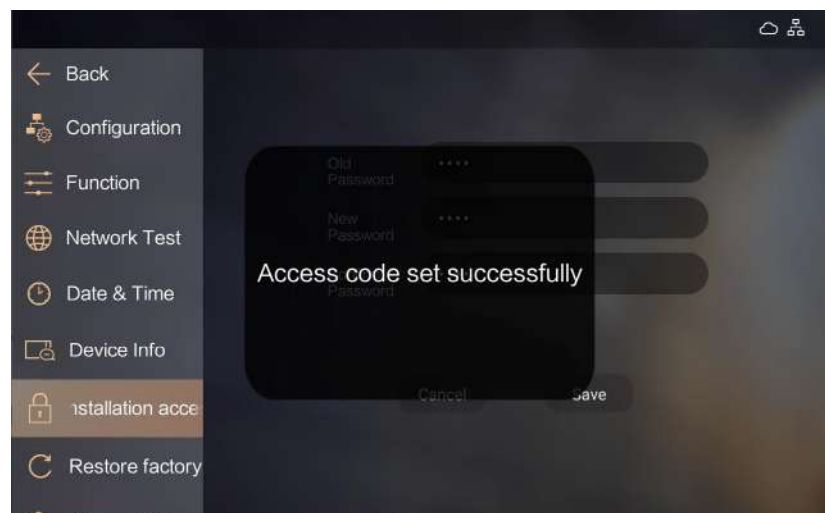

A message confirms the modification

## Restore factory

In this section it is possible to restore the factory values of the device

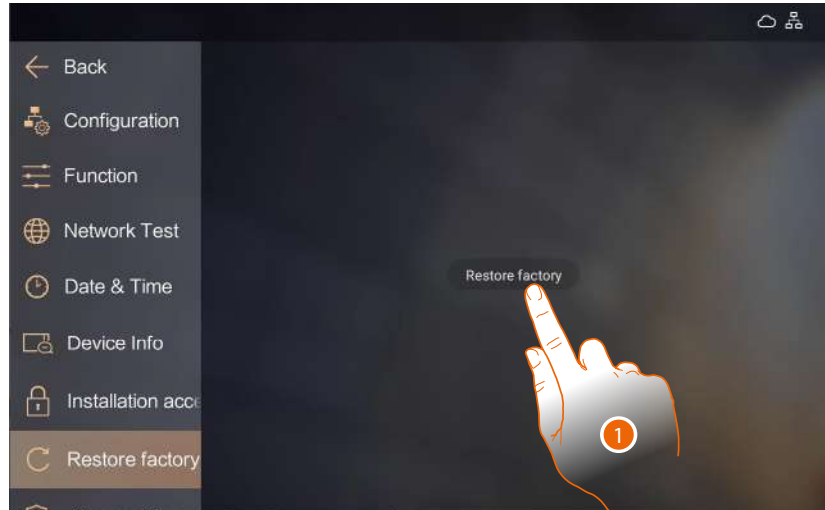

1. Touch to start the procedure

**Warning:** all settings will be deleted and the parameters will be restored to factory values

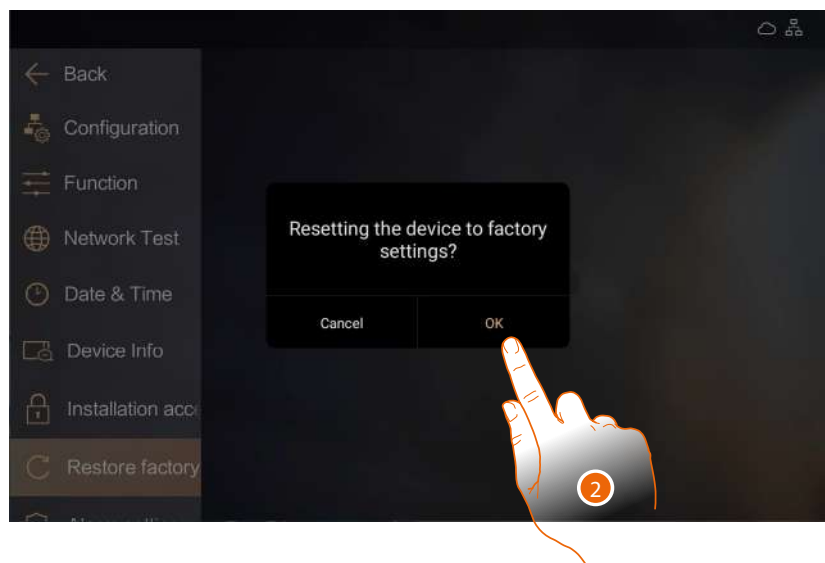

2. Touch to confirm

## Alarm setting

In this section it is possible to display and set the Alarm system probes, connected to the device.

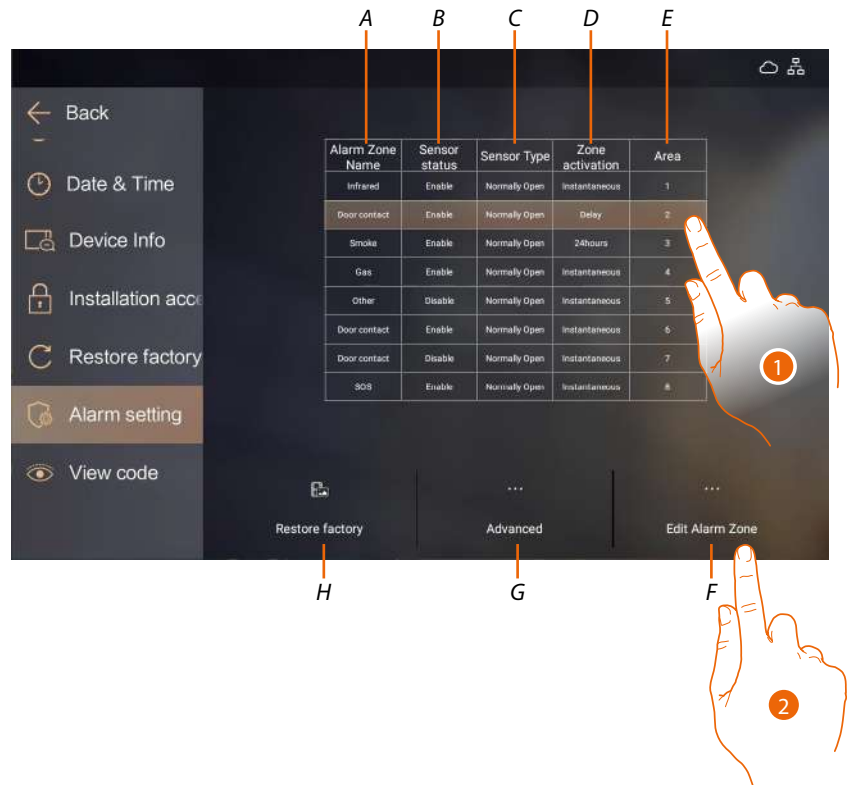

- A Sensor category
- B Sensor status (enable/disable)
- C Sensor type (Normally open/Normally closed)
- D Sensor activation mode
- E Sensor number (it corresponds to the contact from F1 to F8 to which the probe is connected)
- F Set the sensor parameters
- G Set the Advanced parameters
- H Restore the factory values\*

**Warning:** the procedure does not ask for confirmation and is therefore activated immediately

1. Select the sensor to set
2. Touch to open the setting screen

## Sensor parameters

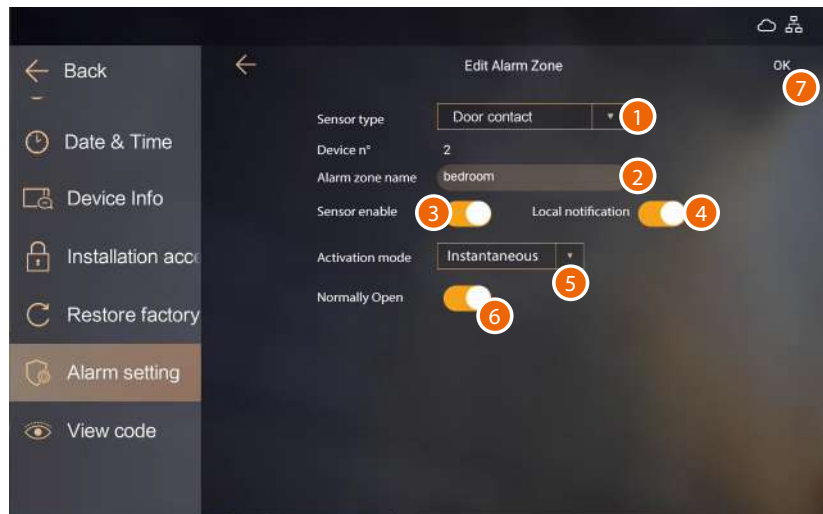

1. Select the type of sensor based on the device connected among:
  - SOS
  - Smoke
  - Gas
  - Infrared
  - Door contact
  - Other
2. Enter the zone name
3. Enable/disable the sensor
4. Enable the reception of a notification on the device when an alarm is generated
5. Select the zone activation mode
6. Select if the probe is normally open or closed
7. Touch to confirm the modifications

### Probe activation mode

Different parameters must be entered according to the type of delay:

Activation mode	Operation	Additional parameters
24hours	The sensor is always active and the alarm is given at a certain time after the triggering condition occurs	Alarm delay (0-255s)
Instantaneous	The alarm is immediately communicated	
Delay	The alarm is given at a certain time after the triggering condition occurs	Alarm delay (0-255s)
	The alarm is given at a certain time after the user gives the command.	Defence delay (0-255s) (activation delay)
Activity check	The alarm is communicated immediately, if the sensor does not detect activities for a preset time	
Scheduled	Scheduled activation	Start time (0-23:59)
	Scheduled activation	End time (0-23:59)

## Advanced parameters

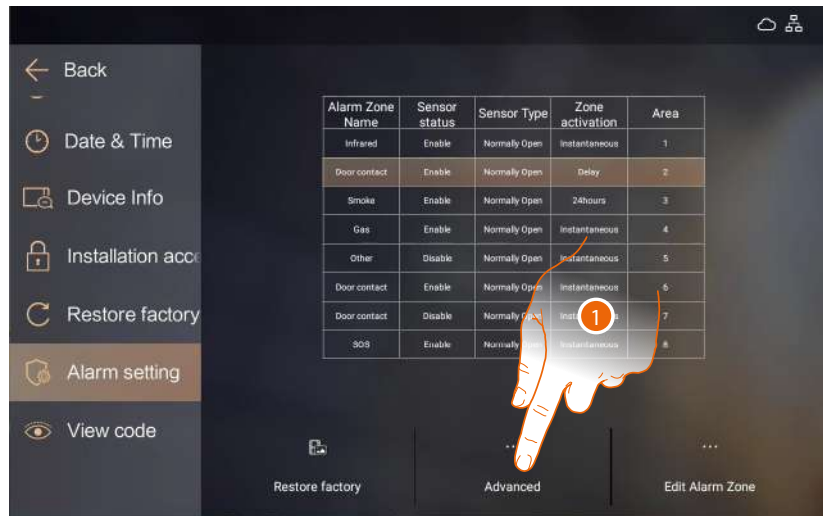

1. Touch to modify the advanced settings

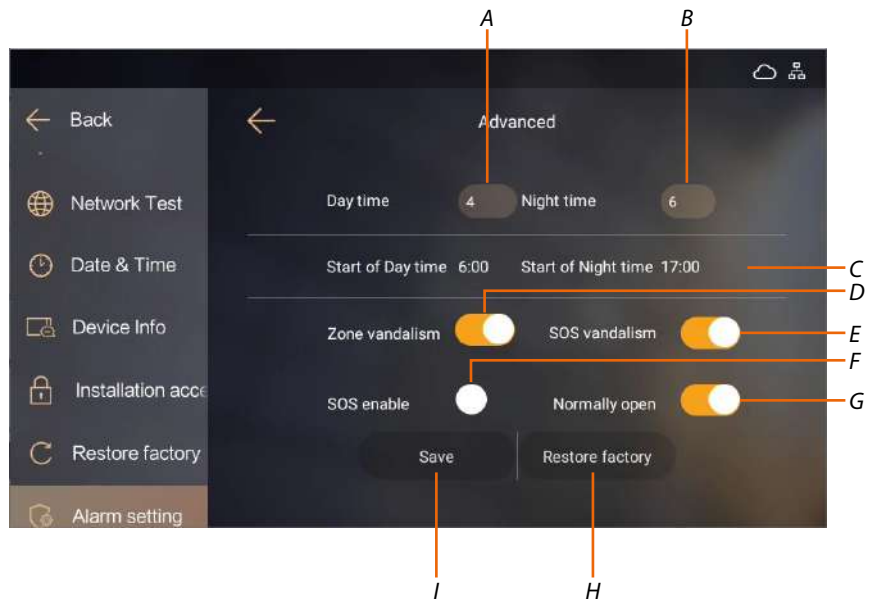

- A It sets the maximum time in which the sensor can detect an action; if the sensor does not give signals for 4 hours it triggers an alarm
- B Same as point A but for the night
- C It displays when the "day" and "night" conditions start. They can only be set by SW.
- D It sets the type of alarm detection (from F1 to F8), which can be of two types:  
 Disabled (Detection of open - closed)  
 Enabled (Detection of open - closed - cable cutting - short circuit)
- E It sets the type of SOS alarm detection, which can be of two types:  
 Disabled (Detection of open - closed)  
 Enabled (Detection of open - closed - cable cutting - short circuit)
- F It enables the SOS sensor on the back of the device to which an extra SOS sensor can be connected.
- G Disabled (NC) - enabled (NO)
- H Restore the factory settings
- I Save the settings

## View access

In this section it is possible to display the passwords or the system access codes

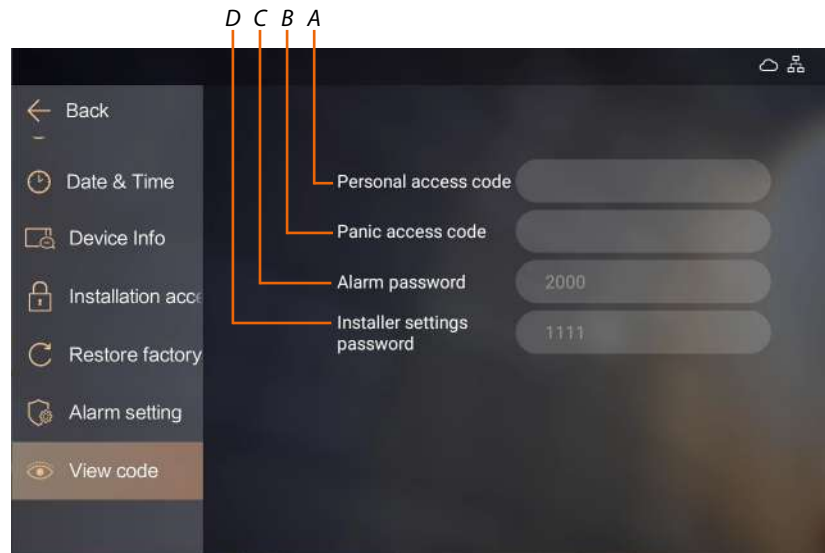

**A** It displays the code which opens the last EP of my community, i.e. the EP closest to the apartment, from those to which I have access (default 4321\*).  
*Example: if they are enabled to all the accesses (complete Area/Building/Riser/Floor/Apartment structure) I set the code which opens the Apartment EP.*

**B** It displays the emergency code (default 4321\*) that opens the door and at the same time sends an alarm message to the GS.  
*Example: if a criminal forces me to forcibly open the door.*

**Note:** to activate the code, there must be a resident associated with the apartment in the SW (see SW manual).

**C** It displays the code that disarms the alarm

**D** It displays the installer password

## Firmware update

If a firmware update is available, the system sends an alert message

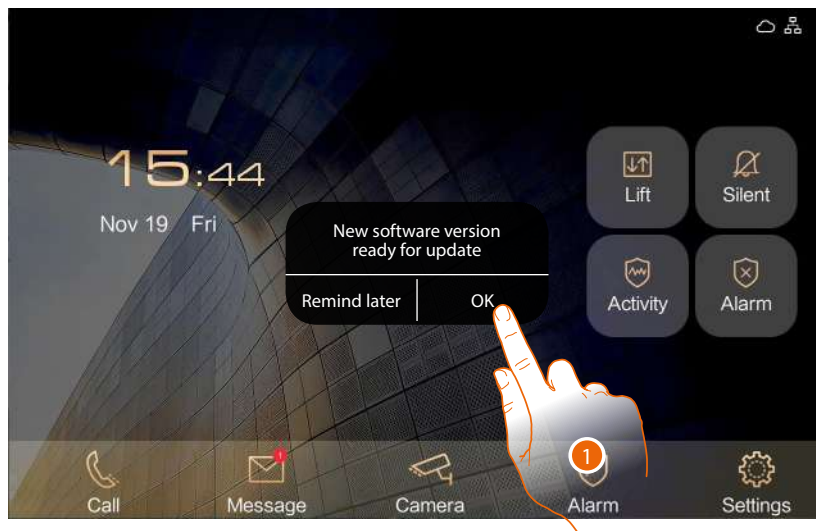

1. Touch to update



BTicino SpA  
Viale Borri, 231  
21100 Varese  
[www.bticino.com](http://www.bticino.com)

---