

PRODUCT DATASHEET

FL PFM 20 W 4000 K SYM 100 BK

FLOODLIGHT 20 W | Versatile floodlight with up to 2400 lm light output



Areas of application

- Replacement for floodlights with halogen lamps
- Outdoor use (IP65)
- Public areas
- Building facades
- Construction areas
- Gardens, balconies and other outdoor areas

Product benefits

- Bright, robust and durable
- Safe and very uniform illumination, due to frosted and tempered glass diffuser
- No upper light output ratio (ULOR 0%) when mounted at 0° tilt
- Energy savings of up to 90 % compared to halogen lamp floodlights
- 5 years guarantee

Product features

- Reflector-based, symmetric light distribution with 100° x 100° beam angle
- Integrated wide voltage driver, suitable for 100 - 277 V AC
- Surge protection: up to 4 kV (L/N-PE), 2 kV (L-N)
- Mounting bracket with 30° angle and wide rotation area
- Pre-installed, flexible 1 m cable (H05RN-F), wrapped 3 x 1.0 mm² single wires



TECHNICAL DATA

Electrical data

Nominal wattage	20.00 W
Operating mode	Integrated LED driver
Nominal voltage	100...277 V
Nominal current	98 mA
Inrush current	5.68 A
Inrush current time T_{h50}	35 μ s
Power factor λ	> 0,90
Mains frequency	50...60 Hz
Max. no. of lum. on circuit break. B16 A	93
Max. no. of lum. on circuit break. C10 A	67
Max. no. of lum. on circuit break. C16 A	108
Total harmonic distortion	< 20 %

Luminaire control gear data

Output current	230 mA
ECG - Output ripple current	< 50 %

Photometrical data

Color temperature	4000 K
Luminous flux	2400 lm
Luminous efficacy	120 lm/W
Light color (designation)	Cool White
Standard deviation of color matching	≤ 5 sdc _m
Color rendering index Ra	≥ 80

Light technical data

Beam angle	100 ° x 100 °
------------	---------------

Dimensions & weight

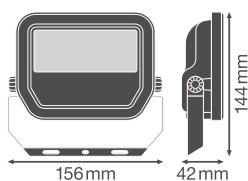

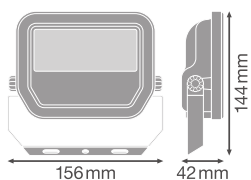

Length	144.00 mm
Height	42.00 mm
Width	156.00 mm
Cable length	1000 mm
Product weight	520.00 g

Colors & materials

Body material	Aluminum
Product color	Black
Housing color	Black
Light emitting surface material	Glass

Temperatures & operating conditions

Ambient temperature range	-30...+50 °C
---------------------------	--------------

Lifespan

Number of switching cycles	100000
Lifespan L70/B50 at 25 °C	70000 h
Lifespan L80/B10 at 25 °C	55000 h
Lifespan L90/B10 at 25 °C	35000 h

Additional product data

Mounting type	Surface
Mounting location	Wall / Ceiling / Floor
Product remark	Available from July 2020

Capabilities

Adjustable	Yes
Dimmable	No
Type of connection	Cable, 3-pole
LED module replaceable	Not replaceable



Certificates & standards

Protection class IK (shock resistance)	IK07
Glow Wire Test according to IEC 60695-2-12	650 °C
Photobiological safety group acc. to EN62778	RG1
Photobiological safety group acc. to EN62471	RG1
Protection class	I
Type of protection	IP65
Ball shot safe	No
Standards	CE / CB / ENEC / EAC / RoHS
Luminaire with limited surface temperature, class "D"	No

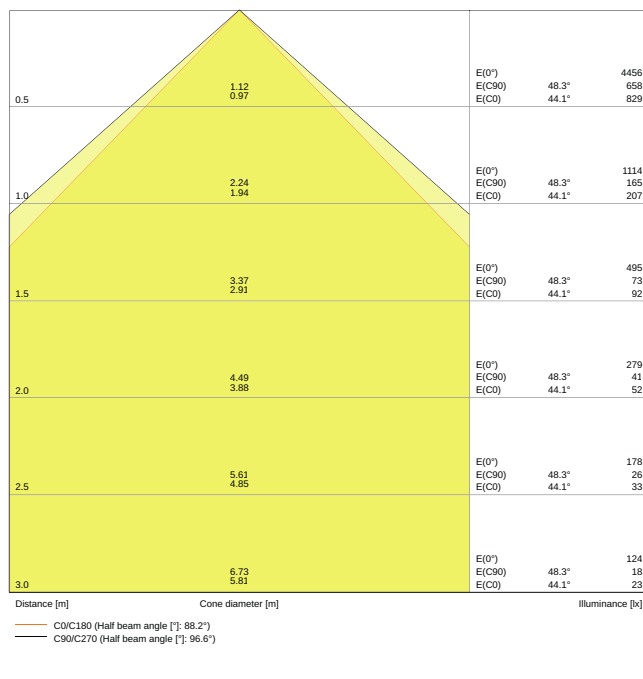

LDC typ cone

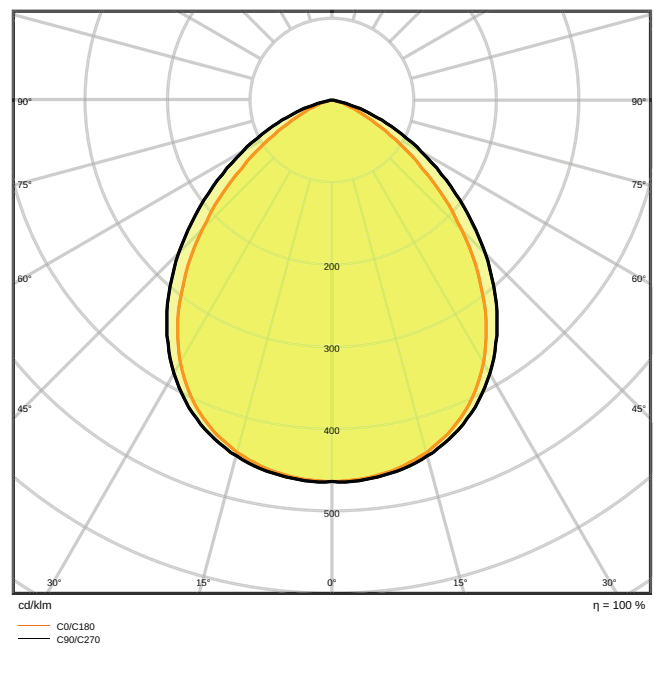

LDC typ polar











LOGISTICAL DATA

Temperature range at storage	-40...+70 °C
------------------------------	--------------

DOWNLOAD DATA



DOWNLOAD DATA

	User instruction FLOODLIGHT
	Tender documents Tender Text 4058075421011
	Certificates EAEC N RU D-DE.MYu62.B.01076 20 16.03.2020-15.03.2025
	Declarations of conformity FL PFM
	IES file (IES) FL PFM 20W4000K SYM 100 BK
	LDT file (Eulumdat) FL PFM 20W4000K SYM 100 BK
	R3D file (Relux 3D Model) FL PFM 20W
	M4D file (3D Model with rotation axis) FL PFM 20W
	UGR file (UGR table) FL PFM 20W4000K SYM 100 BK
	Packaging insert Legal insert

LOGISTICAL DATA

Product code	Packaging unit (Pieces/Unit)	Dimensions (length x width x height)	Gross weight	Volume
4058075421011	Folding box 1	161 mm x 62 mm x 135 mm	572.00 g	1.35 dm ³
4058075421028	Shipping box 12	396 mm x 336 mm x 161 mm	7510.00 g	21.42 dm ³

The mentioned product code describes the smallest quantity unit which can be ordered. One shipping unit can contain one or more single products. When placing an order, for the quantity please enter single or multiples of a shipping unit.

ADDITIONAL CATALOG INFORMATION



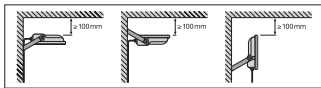
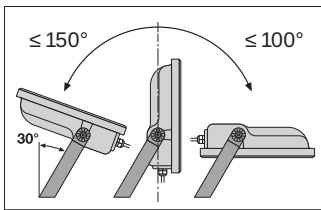

	A	B	C	⚙️	📏
10W	38	60	5.5	2x M4	0.014m ²
20W	58	80	6.5	2x M5	0.018m ²
30W	58	90	6.5	2x M5	0.021m ²
50W	78	110	8.5	2x M6	0.028m ²

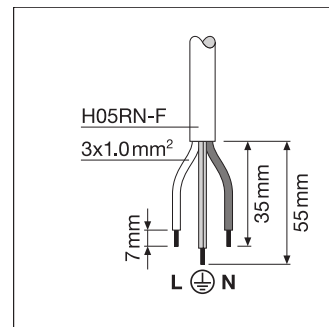

References / Links

- For Guarantee see www.ledvance.com/guarantee

DISCLAIMER

Subject to change without notice. Errors and omission excepted. Always make sure to use the most recent release.