



Commel[®]

2025

Kabelske motalice - heavy duty line Cable Reels - Heavy Duty Line	8	Utikači, natikači i utičnice Plugs, Connectors and Sockets	76
Kabelske motalice - profi line Cable Reels - Profi Line	14	Razdjelnici, adapteri i blokade Adaptors and Direct contact protection	82
Kabelske motalice - hobby line Cable Reels - Hobby Line	22	Kućna automatizacija Home Automation	88
Razdjelni ormari Mobile Power Stations	28	Multimetri i ispitivači napona Multimeters and Voltage Testers	102
Priključni kabeli Connection Cables	30	Zvonca Doorbells	106
Produžni kabeli - profi line Extension Cables - Profi Line	36	Portafoni Door Phones	112
Produžni kabeli - hobby line Extension Cables - Hobby Line	46	Ventilatori Exhaust Fans	117
Prenaponska zaštita Surge Protection	52	Automatski osigurači i FID sklopke RCD Switch and Miniature Circuit Breaker	122
Prenosive utičnice Extension Sockets	56	Kućni prekidači i utičnice Home Swithes and Sockets	126
Ugradbene utičnice za namještaj Furniture Sockets	64	Montažni pribor Mounting Accessories	140
CEE utikači, natikači i utičnice CEE Plugs, Connectors and Sockets	70	Spojni pribor Connection Accessories	148

Izolacijski pribor Insulation Accessories	156	LED vodotijesne svjetiljke LED Waterproof Light Fixtures	212
Tuljci i stopice Wire Terminals	160	Panik svjetiljke Emergency Light Fixtures	216
Električarski alati Hand Tools	164	LED Highbay LED Highbay	218
LED žarulje LED Bulbs	174	Ulična rasvjeta Street lighting	220
LED trake LED Strip Lights	182	Solarni LED reflektori Solar LED Floodlights	222
Zidne i stropne LED svjetiljke LED Under Cabinet Light Fixtures	186	LED reflektori LED Floodlights	226
Zidne i stropne svjetiljke Bulkhead Light Fixtures	192	Akumulatorski LED reflektori Rechargeable LED Floodlights	236
LED plafonjere LED Ceiling Lamps	194	Radne i prenosive svjetiljke Inspection and Portable Lamps	240
LED paneli LED Panels	198	Noćna svjetla Night Lights	250
LED ugradbene svjetiljke LED Downlights	208	Detektori pokreta i luksomati Motion Detectors and Photocell Sensors	252
LED cijevi LED Tubes	210	Gra i pribor za rasvjetu Bulb Sockets and Lighting Accessories	258

OZNAKE I NAMJENA KABELA U KATALOGU / CODES AND USAGE GUIDE FOR CABLES IN THE CATALOGUE

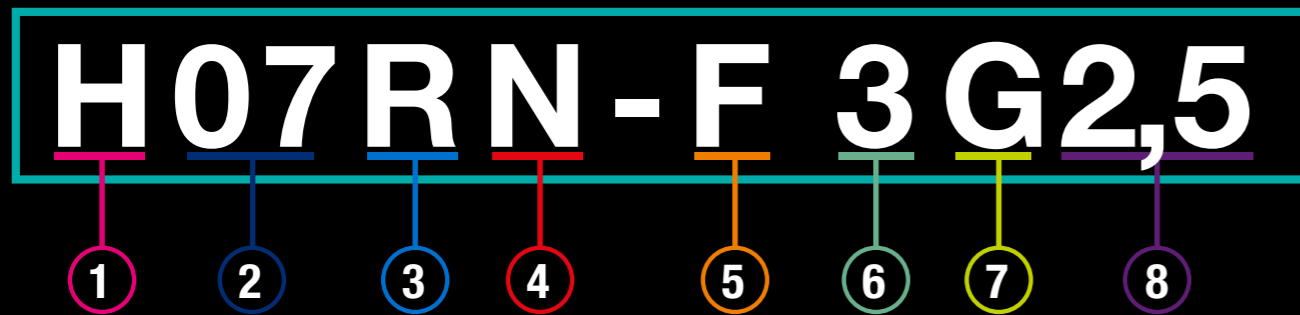

1 VEZA SA STANDARDOM IDENTIFICATION OF DESIGNATION

- H - Harmonizirani standardi
Harmonized standards
- A - Autorizirani nacionalni standardi
Authorized national standards

4 MATERIJAL PLAŠTA SHEAT MATERIAL

- V - PVC - polivinilklorid
Polyvinylchlorid
- V3 - PVC - polivinilklorid, otporan na
nisku temperaturu
Polyvinylchlorid,
low temperature resistant
- R - prirodni ili umjetni kaučuk
Natural or synthetic rubber
- N - polikloroprenski kaučuk
Polychloroprene rubber
- T - opleat od pamuka
Textile braid over twisted cores
- Q - termoplastična poliuretanska guma
Thermoplastic polyurethane rubber

5 VRSTA VODIČA CONDUCTOR TYPE

- F - fleksibilni za savitljive vodove
Flexible for flexible cords

6 BROJ VODIČA NUMBER OF CORES

7 UZEMLJENJE PROTECTIVE CONDUCTOR

- G - sa zeleno / žutim vodičem
With green / yellow core
- X - bez zeleno / žutog vodiča
Without green / yellow core

2 NAZIVNI NAPON NOMINAL VOLTAGE

- 01 - 100 V
- 03 - 300 / 300 V
- 05 - 300 / 500 V
- 07 - 450 / 750 V

3 IZOLACIJSKI MATERIJAL INSULATION MATERIALS

- V - PVC - polivinilklorid
Polyvinylchlorid
- V3 - PVC - polivinilklorid, otporan na
nisku temperaturu
Polyvinylchlorid,
low temperature resistant
- R - prirodni ili umjetni kaučuk
Natural or synthetic rubber
- B - elastomerna etilen-propilenska guma
Elastomeric Ethylene-Propylene rubber

8 POPREČNI PRESJEK VODIČA u mm² CONDUCTOR NOMINAL CROSS SECTION in mm²

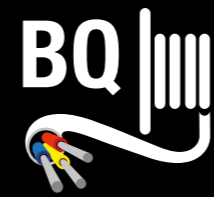

H07BQ-F

Namjena:
Za trajnu vanjsku upotrebu u vlažnim i suhim uvjetima, pri temperaturama od -40°C do +90°C.

Karakteristike:
Visoka fleksibilnost do -40°C. Izvrsna otpornost na mehanička opterećenja, habanje, vremenske prilike, niske temperature, vodu, ulja i masti.

Use:
For long-term outdoor use in wet and dry conditions, at temperatures from -40°C to +90°C.

Characteristics:
High flexibility even at temperatures low as -40°C. Excellent resistance to mechanical and tear stress, weather conditions, low temperatures, water, oils and greases.

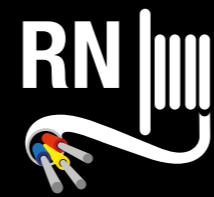

H07RN-F

Namjena:
Za trajnu vanjsku upotrebu u vlažnim i suhim uvjetima, pri temperaturama od -25°C do +60°C.

Karakteristike:
Visoka fleksibilnost i otpornost na ulja, kiseline, vremenske prilike, niske temperature i velika mehanička opterećenja.

Use:
For long-term outdoor use in wet and dry conditions, at temperatures from -25°C to +60°C.

Characteristics:
High flexibility and resistance to oils, acids, weather conditions, low temperatures and high mechanical stress.



AT N07V3V3-F

Namjena:
Za trajnu vanjsku upotrebu u vlažnim i suhim uvjetima, pri temperaturama od -35°C do +70°C.

Karakteristike:
Otpornost na ulja, velika mehanička opterećenja i niske temperature. Visoka fleksibilnost pri temperaturama do čak -35°C.

Use:
For long-term outdoor use in wet and dry conditions, at temperatures from -35°C to +70°C.

Characteristics:
Resistance to oils, high mechanical stress and low temperatures. High flexibility even at temperatures as low as -35°C.



H05RR-F

Namjena:
Za privremenu vanjsku upotrebu, pri temperaturama od -25°C do +60°C.

Karakteristike:
Visoka fleksibilnost i otpornost na manja mehanička opterećenja.

Use:
For short-term outdoor use at temperatures from -25°C to +60°C.

Characteristics:
High flexibility and resistance to low mechanical stress.



H05VV-F

Namjena:
Za svakodnevnu upotrebu u suhim uvjetima, pri temperaturama od +5°C do +70°C.

Karakteristike:
Visoka fleksibilnost i otpornost na manja mehanička opterećenja.

Use:
For everyday use in dry conditions, at temperatures from +5°C to +70°C.

Characteristics:
High flexibility and resistance to low mechanical stress.

DOŽIVOTNO JAMSTVO

Commel kabelske motalice se već dugi niz godina ističu svojom kvalitetom i pouzdanošću. Zahvaljujući širokom asortimanu, svaki će korisnik u našoj ponudi pronaći idealnu kabelsku motalicu za svoje potrebe. Proizvodi iz ove kategorije opremljeni su vrhunskim komponentama, ručno su sastavljeni i pažljivo prekontrolirani prije isporuke. Svaki pojedini artikl prolazi završno ispitivanje po sistemu dvostruke kontrole, te je označen serijskim brojem radi osiguravanja sljedivosti. Kao dodatnu sigurnost, od sada svim kupcima Commel kabelskih motalica dajemo DOŽIVOTNO JAMSTVO. Kupnjom Commel kabelske motalice dobivate vrhunski proizvod europske kvalitete koji ćete koristiti doživotno.

ŠTO JE POKRIVENO COMMEL DOŽIVOTNIM JAMSTVOM?

Commel doživotno jamstvo pokriva sve tvorničke greške, nedostatke u materijalu ili nedostatke u izradi koji mogu utjecati na funkciju proizvoda, a koji su uočeni pri normalnoj upotrebi i poštivanju svih tehničkih specifikacija proizvoda.

KOLIKO TRAJE JAMSTVO?

Doživotno! Ovdje nema trikova ni sitnih slova. Doživotno jamstvo doslovno i znači doživotno jamstvo! Jamstvo vrijedi do kraja životnog vijeka svake osobe koja kupi kabelsku motalicu Commel sa oznakom doživotnog jamstva i registrira se na našim web stranicama.

KAKO AKTIVIRATI JAMSTVO?

Za aktivaciju doživotnog jamstva potrebno je registrirati proizvod u roku trideset (30) dana od dana kupnje. Obrazac za registraciju proizvoda nalazi se na linku: <http://www.commel.hr/aktivacija-jamstva/>
Nakon registracije ćete dobiti Vaš osobni certifikat doživotnog jamstva.

TKO MOŽE KORISTITI DOŽIVOTNO JAMSTVO?

Commel doživotno jamstvo može koristiti isključivo originalni kupac proizvoda. Jamstvo nije prenosivo na druge osobe.

LIFETIME WARRANTY

Commel cable reels have been well known for their quality and safety for many years. Thanks to a wide assortment, every user can find the ideal cable reel for their needs. The products from this category are equipped with top quality components, hand-assembled and carefully checked before delivery. During the production, each item passes through the double checking system before the final quality control check and is marked with a serial number to ensure the traceability.

To prove our confidence in their quality and safety, we now provide LIFETIME WARRANTY to all buyers of Commel cable reels. Purchasing the Commel cable reels, you get a top quality European product you will use for a lifetime.

WHAT IS COVERED UNDER THE COMMEL LIFETIME WARRANTY?

Commel Lifetime Warranty covers all manufacturing defects, as well as defects in materials and workmanship that may affect the function of the product, which are noticed when used in normal conditions and in accordance with all technical specifications of the product.

HOW LONG THE WARRANTY LASTS?

A lifetime! There are no tricks or small print here. Lifetime Warranty literally means lifetime warranty! It means that it covers a lifetime of any person who buys the Commel cable reel with a Lifetime Warranty mark and is registered on our web site.

HOW TO ACTIVATE THE LIFETIME WARRANTY?

To activate the Lifetime Warranty, you must register the product within thirty (30) days from the date of purchase. The product registration form is available on the following link: <http://www.commel.hr/en/warranty-activation/>
After the registration you will receive your personal Lifetime Warranty Certificate.

WHO CAN USE THIS LIFETIME WARRANTY?

Commel Lifetime Warranty can only be used by the original buyer of the product. The warranty is not transferable to other persons.



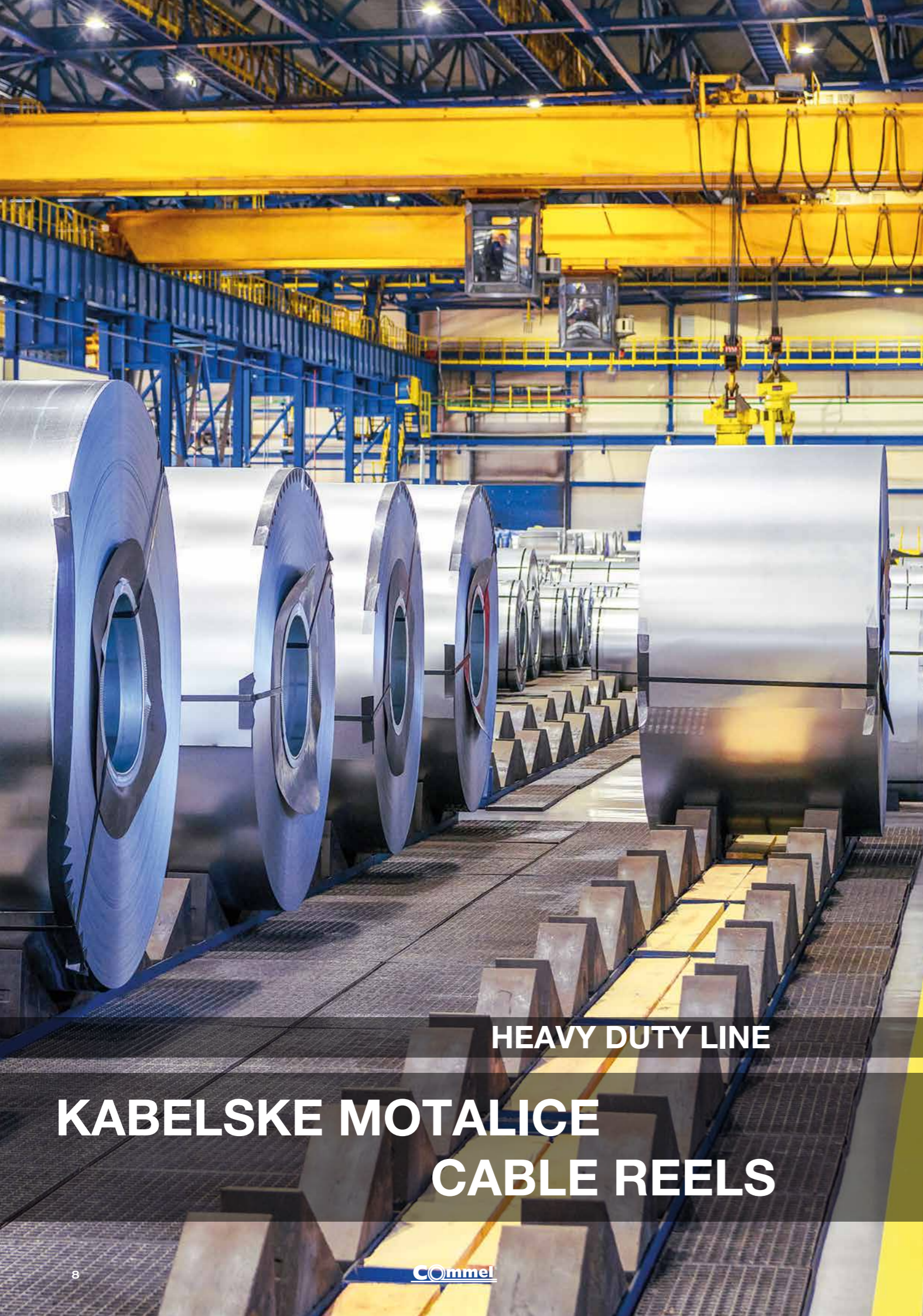

HEAVY DUTY LINE

KABELSKE MOTALICE CABLE REELS



Utičnice / Sockets
1 x CEE 400 V~ / 16 A
2 x 230 V~ / 16 A

Utikač / Plug
CEE 400 V~ / 16 A

Stupanj zaštite / IP grade
IP44

Promjer metalice / Reel diameter
280 mm

Kom.kutija / Pcs.ctn.
1

Made in Europe



šifra / art. no.	kabel / cable	boja kabela / cable color	presjek kabela / cable cross section	dužina / length
200-395 (EAN 3856024405560)	H07BQ-F	●	5G2,5	25 m
200-396 (EAN 3856024405577)	H07BQ-F	●	5G1,5	40 m
200-390 (EAN 3858890447644)	H07RN-F	○	5G2,5	25 m
200-392 (EAN 3858890447651)	H07RN-F	○	5G1,5	40 m
200-391 (EAN 3858890444506)	AT N07V3V3-F	●	5G2,5	25 m
0938 (EAN 3859888761957)	H05RR-F	○	5G2,5	25 m

Značajke
 Ugrađena zaštita od preopterećenja, termoprekidač
 Utičnice s poklopcem omogućavaju stupanj zaštite IP44
 Kočnica koja sprječava nekontrolirano odmatanje kabela

Features
 Built in overload protection, thermo switch
 Socket with lid provide IP44 degree of protection
 Brake mechanism that prevents the cable from accidental unwinding



Utičnice / Sockets
1 x 400 V~ / 16 A
2 x 230 V~ / 16 A

Utikač / Plug
400 V~ / 16 A

Stupanj zaštite / IP grade
IP44

Promjer motalice / Reel diameter
280 mm

Kom.kutija / Pcs.ctn.
1

Made in Europe

Značajke

Ugrađena zaštita od preopterećenja, termoprekidač
 Utičnice s poklopcem omogućavaju stupanj zaštite IP44
 Kočnica koja sprječava nekontrolirano odmatanje kabela

Features

Built in overload protection, thermo switch
 Socket with lid provide IP44 degree of protection
 Brake mechanism that prevents the cable from accidental unwinding



Utičnice / Sockets
4 x 230 V~ / 16 A

Utikač / Plug
230 V~ / 16 A

Stupanj zaštite / IP grade
IP44

Promjer motalice / Reel diameter
300 mm

Kom.kutija / Pcs.ctn.
1

Made in Europe

Značajke

Ugrađena zaštita od preopterećenja, termoprekidač
 Utičnice s poklopcem omogućavaju stupanj zaštite IP44
 Rotirajuća ergonomska ručka

Features

Built in overload protection, thermo switch
 Socket with lid provide IP44 degree of protection
 Rotating ergonomic handle



ANTI-TWIST
 TECHNOLOGY



šifra / art. no.	kabel / cable	boja kabela / cable color	presjek kabela / cable cross section	dužina / length
200-393 (EAN 3858890447668)	H07RN-F	○	5G2,5	25 m
200-394 (EAN 3858890447675)	AT N07V3V3-F	●	5G2,5	40 m
0934 (EAN 3859888761971)	H05RR-F	○	5G2,5	25 m

šifra / art. no.	kabel / cable	boja kabela / cable color	presjek kabela / cable cross section	dužina / length
200-383 (EAN 3856024405584)	H07BQ-F	●	3G1,5	50 m
200-381 (EAN 3858890447590)	H07RN-F	○	3G1,5	50 m
200-382 (EAN 3858890447606)	AT N07V3V3-F	●	3G1,5	50 m



Utičnice / Sockets
4 x 230 V~ / 16 A

Utikač / Plug
230 V~ / 16 A

Stupanj zaštite / IP grade
IP44

Promjer motalice / Reel diameter
300 mm

Kom.kutija / Pcs.ctn.
1

Made in Europe



H07BQ-F
AT N07V3V3-F

šifra / art. no.	boja kabela / cable color	presjek kabela / cable cross section	dužina / length
200-375 (EAN 3856024405591)	●	3G2,5	40 m
200-376 (EAN 3856024405607)	●	3G1,5	50 m
200-377 (EAN 3856024405614)	●	3G1,5	30 m
0983 (EAN 3858883831542)	○	3G2,5	40 m
200-364 (EAN 3858890447705)	○	3G1,5	50 m
200-366 (EAN 3858890447729)	○	3G1,5	30 m
200-363 (EAN 3858890444513)	●	3G2,5	40 m
200-365 (EAN 3858890447712)	●	3G1,5	50 m
200-367 (EAN 3858890447736)	●	3G1,5	30 m

Značajke
Utičnice s poklopcem omogućavaju stupanj zaštite IP44
Ugrađena zaštita od preopterećenja, termoprekidač
Svjetlosni indikator napona
Rotirajuća ergonomska ručica

Features
Socket with lid provide IP44 degree of protection
Built in overload protection, thermo switch
Power indicator light
Rotating ergonomic handle

Utičnice / Sockets
3 x 230 V~ / 16 A

Utikač / Plug
230 V~ / 16 A

Stupanj zaštite / IP grade
IP44

Promjer motalice / Reel diameter
280 mm

Kom.kutija / Pcs.ctn.
1

Made in Europe



šifra / art. no.	kabel / cable	boja kabela / cable color	presjek kabela / cable cross section	dužina / length
200-378 (EAN 3856024405621)	H07BQ-F	●	3G2,5	50 m
200-379 (EAN 3856024405638)	H07BQ-F	●	3G1,5	50 m
200-321 (EAN 3856024401234)	H07RN-F	○	3G2,5	50 m
200-322 (EAN 3856024401241)	H07RN-F	○	3G1,5	50 m
200-323 (EAN 3856024401258)	AT N07V3V3-F	●	3G2,5	40 m
200-324 (EAN 3856024401265)	AT N07V3V3-F	●	3G1,5	50 m

Značajke
Ugrađena zaštita od preopterećenja, termoprekidač
Svjetlosni indikator napona
Rotirajuća ergonomska ručica
Metalni bubanj

Features
Built in overload protection, thermo switch
Power indicator light
Rotating ergonomic handle
Metal reel



PROFI LINE

KABELSKE MOTALICE CABLE REELS



Utičnice / Sockets
4 x 230 V~ / 16 A

Stupanj zaštite / IP grade
IP44

Kom.kutija / Pcs.ctn.
1

Utikač / Plug
230 V~ / 16 A

Promjer motalice / Reel diameter
300 mm

Made in Europe

šifra / art. no.	kabel / cable	boja kabela / cable color	presjek kabela / cable cross section	dužina / length
0912 (EAN 3859888558779)	H05VV-F	○	3G2,5	50 m
0932 (EAN 3859888558854)	H05RR-F	○	3G2,5	50 m

Značajke
 Ugrađena zaštita od preopterećenja, termoprekidač
 Utičnice s poklopcem omogućavaju stupanj zaštite IP44
 Rotirajuća ergonomska ručka
 Svjetlosni indikator napona

Features
 Built in overload protection, thermo switch
 Socket with lid provide IP44 degree of protection
 Rotating ergonomic handle
 Power indicator light





Utičnice / Sockets
3 x 230 V~ / 16 A

Utikač / Plug
230 V~ / 16 A

Stupanj zaštite / IP grade
IP44

Kom.kutija / Pcs.ctn.
1

Ø 280 mm

Made in Europe

Utičnice / Sockets
3 x 230 V~ / 16 A

Utikač / Plug
230 V~ / 16 A

Stupanj zaštite / IP grade
IP44

Promjer metalice / Reel diameter
280 mm

Kom.kutija / Pcs.ctn.
1

Made in Europe

H07RN-F

AT N07V3V3-F

H05RRR-F

H05RRR-F

šifra / art. no.	boja kabela / cable color	presjek kabela / cable cross section	dužina / length
200-360 (EAN 3858890447743)	○	3G2,5	40 m
200-373 (EAN 3856024405546)	○	3G2,5	25 m
200-371 (EAN 3856024403474)	●	3G2,5	25 m
200-362 (EAN 3858890444520)	●	3G1,5	40 m
200-361 (EAN 3858890444537)	●	3G1,5	25 m
0982 (EAN 3859889306973)	○	3G2,5	40 m
0980 (EAN 3859889306966)	○	3G2,5	25 m
200-368 (EAN 3858890447750)	○	3G1,5	50 m
200-369 (EAN 3858890447767)	○	3G1,5	25 m
200-370 (EAN 3858890447774)	○	3G1,5	15 m

H07RN-F

H05RRR-F

AT N07V3V3-F

šifra / art. no.	boja kabela / cable color	presjek kabela / cable cross section	dužina / length
200-340 (EAN 3858890447781)	○	3G2,5	40 m
200-374 (EAN 3856024405553)	○	3G2,5	25 m
0930 (EAN 3859889306959)	○	3G2,5	40 m
0928 (EAN 3859889306942)	○	3G2,5	25 m
200-341 (EAN 3858890447798)	○	3G1,5	50 m
200-342 (EAN 3858890447804)	○	3G1,5	25 m
200-372 (EAN 3856024403481)	●	3G2,5	25 m
200-343 (EAN 3858890447811)	●	3G1,5	40 m
200-344 (EAN 3858890447828)	●	3G1,5	25 m

Značajke
Utičnice s poklopcem omogućavaju stupanj zaštite IP44
Ugrađena zaštita od preopterećenja, termoprekidač
Svjetlosni indikator napona

Features
Socket with lid provide IP44 degree of protection
Built in overload protection, thermo switch
Power indicator light

Značajke
Utičnice s poklopcem omogućavaju stupanj zaštite IP44
Ugrađena zaštita od preopterećenja, termoprekidač
Svjetlosni indikator napona
Rotirajuća ergonomska ručica
Metalni bubanj

Features
Socket with lid provide IP44 degree of protection
Built in overload protection, thermo switch
Power indicator light
Rotating ergonomic handle
Metal reel

Utičnice / Sockets
3 x 230 V~ / 16 A

Stupanj zaštite / IP grade
IP44

Kom.kutija / Pcs.ctn.
1

Utikač / Plug
230 V~ / 16 A

Promjer metalice / Reel diameter
280 mm

Made in Europe



šifra / art. no.	kabel / cable	boja kabela / cable color	presjek kabela / cable cross section	dužina / length
200-325 (EAN 3856024401272)	H05RR-F	○	3G2,5	50 m

Značajke
Utičnice s poklopcem omogućavaju stupanj zaštite IP44
Ugrađena zaštita od preopterećenja, termoprekidač
Svjetlosni indikator napona; metalni bubanj
Rotirajuća ergonomska ručica

Features
Socket with lid provide IP44 degree of protection;
Built in overload protection, termo switch
Power indicator light; Metal reel
Rotating ergonomic handle

Utičnice / Sockets
3 x 230 V~ / 16 A

Stupanj zaštite / IP grade
IP44

Utikač / Plug
230 V~ / 16 A

Promjer metalice / Reel diameter
280 mm

Made in Europe



šifra / art. no.	kabel / cable	boja kabela / cable color	presjek kabela / cable cross section	dužina / length
200-313 (EAN 3858890447835)	H07RN-F	○	3G1,5	40 m
0945 (EAN 3858883834222)	H05RR-F	○	3G1,5	50 m
0944 (EAN 3858883834260)	H05RR-F	○	3G1,5	25 m
200-312 (EAN 3858890444544)	AT N07V3V3-F	●	3G1,5	40 m
200-311 (EAN 3858890444551)	AT N07V3V3-F	●	3G1,5	25 m

Značajke
Ugrađena zaštita od preopterećenja, termoprekidač
Svjetlosni indikator napona
Gumirani trostruki razdjelnik otporan na udarce

Features
Built in overload protection, termo switch
Power indicator light
Shock resistant rubber 3-way socket outlet

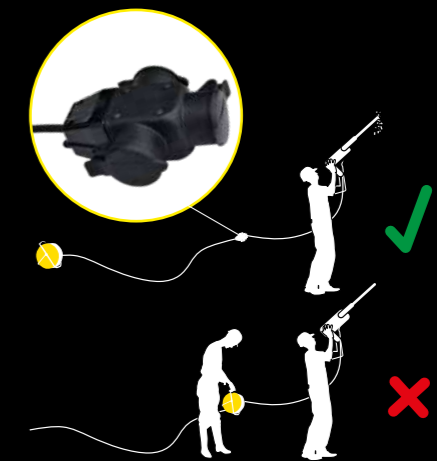



Utičnice / Sockets
1 x 230 V~ / 16 A

Utikač / Plug
230 V~ / 16 A

Promjer motalice / Reel diameter
280 mm

Stupanj zaštite / IP grade
IP44

Kom.kutija / Pcs.ctn.
1

Made in Europe

šifra / art. no.	kabel / cable	boja kabela / cable color	presjek kabela / cable cross section	dužina / length
200-351 (EAN 3858890447842)	AT N07V3V3	●	3G1,5	25 m
200-352 (EAN 3858890447859)	AT N07V3V3	●	3G1,5	40 m

Značajke	Features
Ugrađena zaštita od preopterećenja, termoprekidač	Built in overload protection, thermo switch
Svjetlosni indikator napona	Power indicator light
PVC ručkica	PVC handle

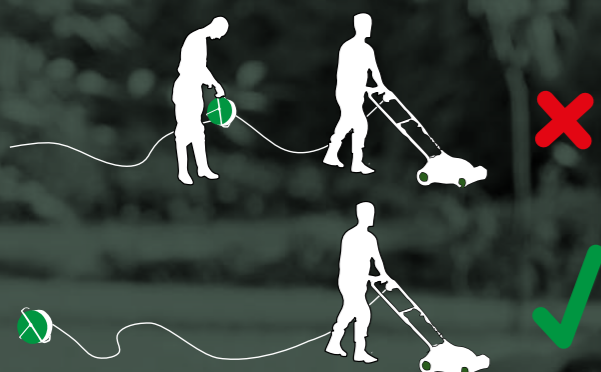

Namjena
Upotreba u marinama, ribogojilištima, za električni priključak plovila

Purpose
Suitable for use in marinas, fish farms, with boat electrical connection



Utikač / Plug
CEE 230 V~ / 16 A

Kabel / Cable
MarinFlex

Stupanj zaštite / IP grade
IP44

Promjer motalice / Reel diameter
280 mm

Kom.kutija / Pcs.ctn.
1

Made in Europe

slika / photo	šifra / art. no.	utičnice / sockets	boja kabela / cable color	presjek kabela / cable cross section	dužina / length
1	200-398 (EAN 3858890449693)	1 x CEE 230 V~ / 16 A 2 x 230 V~ / 16 A	●	3G1,5	25 m
2	200-397 (EAN 3858890449686)	CEE 230 V~ / 16 A	●	3G1,5	25 m

Značajke

*1,2 Ugrađena zaštita od preopterećenja, termoprekidač
Utičnice s poklopcem omogućavaju stupanj zaštite IP44
Kočnica koja sprječava nekontrolirano odmatanje kabela

*2 Svjetlosni indikator napona
PVC ručkica

Features

*1,2 Built in overload protection, thermo switch
Sockets with lid provide IP44 degree of protection
Brake mechanism that prevents cable from accidental unwinding

*2 Power indicator light
PVC handle



HOBBY LINE

KABELSKE MOTALICE CABLE REELS



Utičnice / Sockets
4 x 230 V~ / 16 A

Utikač / Plug
230 V~ / 16 A

Stupanj zaštite / IP grade
IP20

Promjer motalice / Reel diameter
280 mm

Kom.kutija / Pcs.ctn.
1

Made in Europe

H05RRR-F

H05VV-F

šifra / art. no.	boja kabela / cable color	presjek kabela / cable cross section	dužina / length
0931 (EAN 3859888558847)	○	3G2,5	40 m
0929 (EAN 3859888558830)	○	3G2,5	25 m
0927 (EAN 3859888558823)	○	3G1,5	50 m
0925 (EAN 3859888558816)	○	3G1,5	25 m
0911 (EAN 3859888558762)	○	3G2,5	40 m
0909 (EAN 3859888558755)	○	3G2,5	25 m
0907 (EAN 3859888558748)	○	3G1,5	50 m
0905 (EAN 3859888558731)	○	3G1,5	25 m

Značajke
 Ugrađena zaštita od preopterećenja, termoprekidač
 Rotirajuća ergonomska ručica
 Svjetlosni indikator napona
 Metalni bubanj - PVC ručkica

Features
 Built in overload protection, thermo switch
 Rotating ergonomic handle
 Power indicator light
 Metal reel - PVC handle



Utičnice / Sockets
4 x 230 V~ / 16 A

Utikač / Plug
230 V~ / 16 A

Stupanj zaštite / IP grade
IP20

Kom.kutija / Pcs.ctn.
1

Made in Europe



Utičnice / Sockets
4 x 230 V~ / 16 A

Utikač / Plug
230 V~ / 16 A

Stupanj zaštite / IP grade
IP20

Kom.kutija / Pcs.ctn.
1

Made in Europe

Ø 280 mm

	šifra / art. no.	boja kabela / cable color	presjek kabela / cable cross section	dužina / length
H05RR-F	0981 (EAN 3859888558984)	○	3G2,5	40 m
	0979 (EAN 3859888558977)	○	3G2,5	25 m
	0977 (EAN 3859888558960)	○	3G1,5	50 m
H05VV-F	0961 (EAN 3859888558946)	○	3G2,5	40 m
	0959 (EAN 3859888558939)	○	3G2,5	25 m

Ø 230 mm

	šifra / art. no.	boja kabela / cable color	presjek kabela / cable cross section	dužina / length
H05RR-F	0975 (EAN 3859888558953)	○	3G1,5	25 m

Značajke
Ugrađena zaštita od preopterećenja, termoprekidač
Svjetlosni indikator napona
PVC ručičica

Features
Built in overload protection, thermo switch
Power indicator light
PVC handle

Ø 280 mm

	šifra / art. no.	boja kabela / cable color	presjek kabela / cable cross section	dužina / length
H05W-F	0957 (EAN 3859888558922)	○	3G1,5	50 m
	0956 (EAN 3858883839173)	○	3G1,5	40 m

Ø 230 mm

	šifra / art. no.	boja kabela / cable color	presjek kabela / cable cross section	dužina / length
H05VV-F	0955 (EAN 3859888558915)	○	3G1,5	25 m
	0960 (EAN 3858883839210)	○	3G1,5	20 m
	0953C (EAN 3858883831573)	○	3G1,5	15 m

Značajke
Ugrađena zaštita od preopterećenja, termoprekidač

Features
Built in overload protection, thermo switch





Utičnice / Sockets
1 x 230 V~ / 16 A

Utikač / Plug
230 V~ / 16 A

Stupanj zaštite / IP grade
IP20

Kom.kutija / Pcs.ctn.
1

Made in Europe

Ø 280 mm

H05W-F

šifra / art. no.	boja kabela / cable color	presjek kabela / cable cross section	dužina / length
0993 (EAN 3858890442755)	●	3G1,5	40 m
0992 (EAN 3859889306997)	●	3G1,5	50 m

Ø 230 mm

H05W-F

šifra / art. no.	boja kabela / cable color	presjek kabela / cable cross section	dužina / length
0991 (EAN 3859889306980)	●	3G1,5	25 m

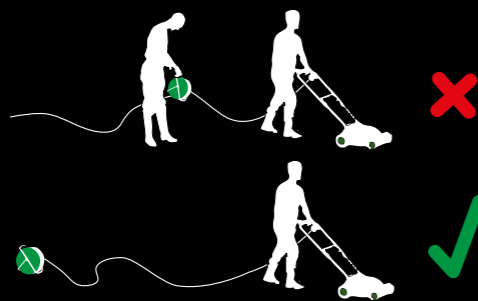

Značajke
Ugrađena zaštita od preopterećenja, termoprekidač
Svjetlosni indikator napona

Features
Built in overload protection, termo switch
Power indicator light



Utičnice / Sockets
4 x 230 V~ / 10 A

Utikač / Plug
230 V~ / 10 A

Stupanj zaštite / IP grade
IP20

Kom.kutija / Pcs.ctn.
1

H05W-F

šifra / art. no.	boja kabela / cable color	presjek kabela / cable cross section	dužina / length
0890 (EAN 3859889306812)	●	3G1	10 m

PRAZNE KABELSKE MOTALICE / EMPTY CABLE REELS

Utičnice / Sockets
4 x 230 V~ / 16 A

Stupanj zaštite / IP grade
IP20

Kom.kutija / Pcs.ctn.
1

Made in Europe

šifra / art. no.	promjer motalice / reel diameter
0998 (EAN 3859888761773)	230 mm
0999 (EAN 3859888761834)	280 mm

Značajke
Ugrađena zaštita od preopterećenja, termoprekidač

Features
Built in overload protection, termo switch



RAZDJELNI ORMARI MOBILE POWER STATIONS

16 A

Utikač / Plug
1 x CEE 16 A | 400 V | 5P

Zaštita / Protection
1 x RCCB 40 A | 4P | 0,03 A
2 x MCB 16 A | 3P | C
2 x MCB 16 A | 1P | C

Stupanj zaštite / IP grade
IP44

Dužina kabela / Cable length
2 m

Kom.kutija / Pcs.ctn.
1

šifra / art. no. presjek kabela /
cable cross section

114-101
(EAN 3856024406734)

H07RN-F
5G2,5

utičnice / sockets

3 x CEE 16 A | 400 V | 5P
5 x Schuko 16 A | 250 V

Made in
Europe

32 A

Utikač / Plug
1 x CEE 32 A | 400 V | 5P

Zaštita / Protection
1 x RCCB 40 A | 4P | 0,03 A
1 x MCB 16 A | 3P | C
3 x MCB 16 A | 1P | C

Stupanj zaštite / IP grade
IP44

Dužina kabela / Cable length
2 m

Kom.kutija / Pcs.ctn.
1

šifra / art. no. presjek kabela /
cable cross section

114-102
(EAN 3856024406741)

H07RN-F
5G4

utičnice / sockets

2 x CEE 16 A | 400 V | 5P
1 x CEE 32 A | 400 V | 5P
5 x Schuko 16 A | 250 V



PRIKLJUČNI KABELEI CONNECTION CABLES

Kabel / Cable
H03VVH2-F

Nazivni napon / Voltage
250 V~

Kom.kutija / Pcs.ctn.
20

Utikač / Plug
2,5 A / 250 V~

Max. opterećenje / Max. load
2,5 A

PRIKLJUČNI KABELEI S EURO UTIKAČEM / CONNECTION CABLES WITH EURO PLUG

šifra / art. no.	boja kabela / cable color	presjek kabela / cable cross section	dužina / length
0114 (EAN 3859888558199)	●	2x0,75	2 m
0115 (EAN 3859888558205)	○	2x0,75	2 m
272-175 (EAN 3856024401968)	●	2x0,75	2 m
272-176 (EAN 3856024401975)	●	2x0,75	2 m
0118 (EAN 3859888558212)	●	2x0,75	3 m
0119 (EAN 3859888558229)	○	2x0,75	3 m

PRIKLJUČNI KABELEI S EURO UTIKAČEM I SKLOPKOM / CONNECTION CABLES WITH EURO PLUG & SWITCH

šifra / art. no.	boja kabela / cable color	presjek kabela / cable cross section	dužina / length
0112 (EAN 3859888558427)	●	2x0,75	2 m
0113 (EAN 3859888558434)	○	2x0,75	2 m
0128 (EAN 3859889306683)	●	2x0,75	2 m
272-185 (EAN 3856024401982)	●	2x0,75	2 m
0116 (EAN 3859889306287)	●	2x0,75	3 m
0117 (EAN 3859889306300)	○	2x0,75	3 m

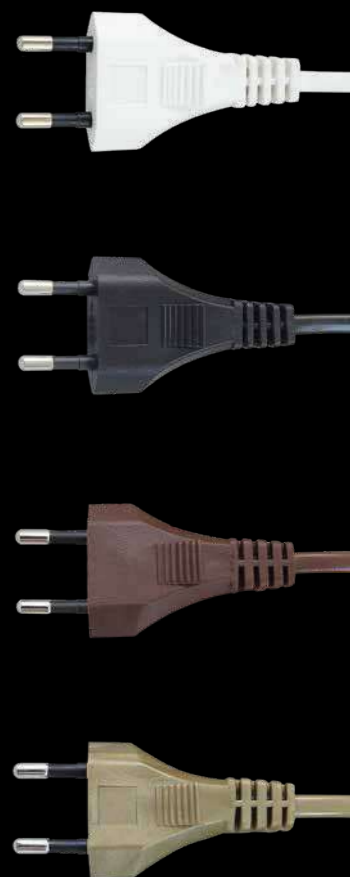

ŠUKO PRIKLJUČNI KABELI S TEKSTILNIM PLAŠTEM /
SCHUKO CONNECTION CABLES WITH TEXTILE SHEATH

Kabel / Cable **H03RT-H** Utikač / Plug **16 A / 250 V~** Nazivni napon / Voltage **250 V~** Kom.kutija / Pcs.ctn. **20**

šifra / art. no.	boja kabela / cable color	presjek kabela / cable cross section	dužina / length	max. opterećenje / max. load
0333X (EAN 3856024408059)	●	3G0,75	2 m	6 A / 1300 W
0339X (EAN 3856024408066)	●	3G0,75	3 m	6 A / 1300 W
272-401X (EAN 3856024408073)	●	3G1	2 m	10 A / 2200 W
272-402X (EAN 3856024408080)	●	3G1	3 m	10 A / 2200 W

ŠUKO PRIKLJUČNI KABELI S GUMENIM PLAŠTEM /
SCHUKO CONNECTION CABLES WITH RUBBER SHEATH

Kabel / Cable **H05RR-F** Utikač / Plug **16 A / 250 V~** Nazivni napon / Voltage **250 V~** Kom.kutija / Pcs.ctn. **10**

šifra / art. no.	boja kabela / cable color	presjek kabela / cable cross section	dužina / length	max. opterećenje / max. load
0631 (EAN 3859888558496)	○	3G2,5	1,5 m	16 A / 3500 W
0635 (EAN 3859888558311)	○	3G2,5	2 m	16 A / 3500 W
0639 (EAN 3859888558328)	○	3G2,5	3 m	16 A / 3500 W
272-301 (EAN 3858890448351)	○	3G1,5	1,5 m	16 A / 3500 W
272-302 (EAN 3858890448368)	○	3G1,5	2 m	16 A / 3500 W
272-303 (EAN 3858890448375)	○	3G1,5	3 m	16 A / 3500 W

Made in Europe

ŠUKO PRIKLJUČNI KABELI S PVC PLAŠTEM /
SCHUKO CONNECTION CABLES WITH PVC SHEATH



Kabel / Cable **H05VV-F**

Utikač / Plug **16 A / 250 V~**

Nazivni napon / Voltage **250 V~**

Kom.kutija / Pcs.ctn. **20**

Made in Europe



3G0,75

3G1

3G1,5

3G2,5A

šifra / art. no.	boja kabela / cable color	dužina / length	max. opterećenje / max. load
0310 (EAN 3859888558601)	●	1,5 m	6 A / 1300 W
0311 (EAN 38598889306508)	○	1,5 m	6 A / 1300 W
0314 (EAN 3859888558236)	●	2 m	6 A / 1300 W
0315 (EAN 38598889306089)	○	2 m	6 A / 1300 W
0318 (EAN 3859888558243)	●	3 m	6 A / 1300 W
0319 (EAN 38598889306102)	○	3 m	6 A / 1300 W
0481 (EAN 3858883833249)	●	1,5 m	10 A / 2200 W
0482 (EAN 3858883833256)	○	1,5 m	10 A / 2200 W
0484 (EAN 3858883833263)	●	2 m	10 A / 2200 W
0486 (EAN 3858883833270)	○	2 m	10 A / 2200 W
0488 (EAN 3858883833287)	●	3 m	10 A / 2200 W
0489 (EAN 3858883833294)	○	3 m	10 A / 2200 W
0512 (EAN 3859888558625)	●	1,5 m	16 A / 3500 W
0511 (EAN 3859888558618)	○	1,5 m	16 A / 3500 W
0514 (EAN 3859888558250)	●	2 m	16 A / 3500 W
0515 (EAN 3859888558670)	○	2 m	16 A / 3500 W
0518 (EAN 3859888558267)	●	3 m	16 A / 3500 W
0519 (EAN 3859888558632)	○	3 m	16 A / 3500 W
0610 (EAN 3859888558472)	●	1,5 m	16 A / 3500 W
0611 (EAN 3859888558489)	○	1,5 m	16 A / 3500 W
0614 (EAN 3859888558274)	●	2 m	16 A / 3500 W
0615 (EAN 3859888558298)	○	2 m	16 A / 3500 W
0618 (EAN 3859888558281)	●	3 m	16 A / 3500 W
0619 (EAN 3859888558304)	○	3 m	16 A / 3500 W



**PRIKLJUČNI KABELOVI ZA ELEKTRIČNE ALATE /
CONNECTION CABLES FOR POWER TOOLS**

Utikač / Plug **250 V~ / 10 A** Nazivni napon / Voltage **250 V~** Boja / Color

šifra / art. no.	kabel / cable	presjek kabela / cable cross section	dužina / length	max. opterećenje / max. load	kom.kutija / pcs.ctn.
272-501 (EAN 3856024405645)	H05RN-F	2x1	2 m	10 A / 2200 W	20
272-502 (EAN 3856024405652)	H05RN-F	2x1	4 m	10 A / 2200 W	20
0282 (EAN 3858883830149)	H05RR-F	2x1	4 m	10 A / 2200 W	20
0283 (EAN 385888383225)	H05RR-F	2x1,5	4 m	16 A / 3500 W	10
0285 (EAN 3859889306362)	H05VV-F	2x1	3,5 m	10 A / 2200 W	20

**TROFAZNI PRIKLJUČNI KABLOVI /
CONNECTION CABLES WITH THREE-PHASE POWER PLUG**

Utikač / Plug **400 V~ / 16 A** Nazivni napon / Voltage **400 V~** Boja / Color **Made in Europe**



šifra / art. no.	kabel / cable	presjek kabela / cable cross section	max. opterećenje / max. load	dužina / length	kom.kutija / pcs.ctn.
0713 (EAN 3859888558564)	H05VV-F	5G2,5	16 A / 10.000 W	1,5 m	10
0715 (EAN 3859888558335)	H05VV-F	5G2,5	16 A / 10.000 W	2 m	10
0719 (EAN 3859888558342)	H05VV-F	5G2,5	16 A / 10.000 W	3 m	10
0733 (EAN 3859888558540)	H05RR-F	5G2,5	16 A / 10.000 W	1,5 m	10
0735 (EAN 3859888558359)	H05RR-F	5G2,5	16 A / 10.000 W	2 m	10
0739 (EAN 3859888558366)	H05RR-F	5G2,5	16 A / 10.000 W	3 m	10

**PRIKLJUČNI KABLOVI ZA STALNI PRIKLJUČAK /
CONNECTION CABLES FOR STOVES**

Dužina kabela / Cable length **1,5 m** Boja / Color

šifra / art. no.	kabel / cable	presjek kabela / cable cross section	max. opterećenje / max. load	nazivni napon / voltage	kom.kutija / pcs.ctn.
0603 (EAN 3859888558502)	H05VV-F	3G2,5	5.000 W	250 V~	10
0711 (EAN 3859888558526)	H05VV-F	5G2,5	12.000 W	400 V~	10
272-201 (EAN 3858883832389)	H05VV-F	3G2,5	5.000 W	250 V~	10



Made in Europe

Priključni kabeli s kontur utikačem se ugrađuju u električne alate s plastičnim kućištem.
Connection cables with contour plug are installed in power tools with plastic housing.

Made in Europe

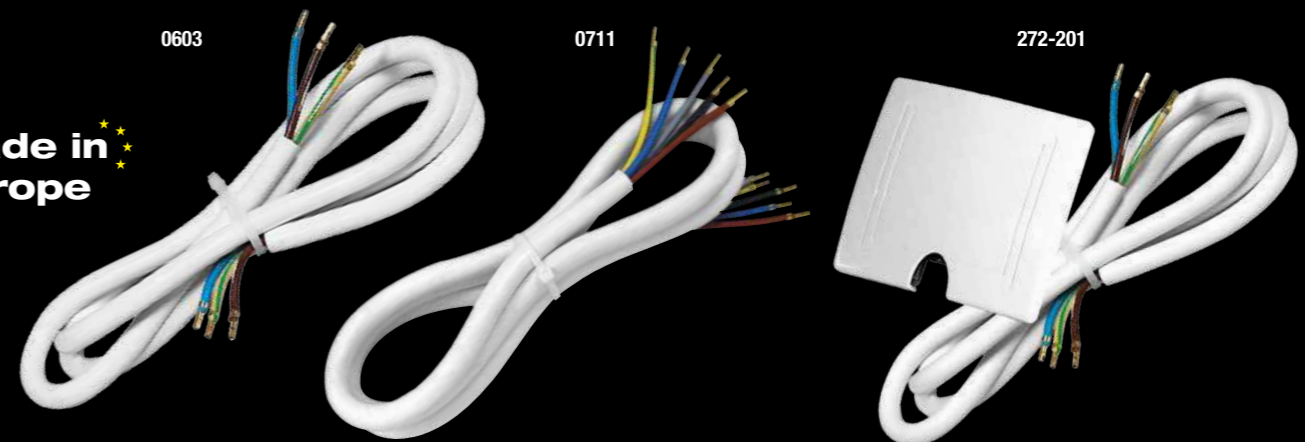



PROFI LINE
PRODUŽNI KABELI
EXTENSION CABLES

Max. opterećenje / Max. load
16 A / 10500 W

Nazivni napon / Voltage
400 V~

Stupanj zaštite / IP grade
IP44

Kom.kutija / Pcs.ctn.
1

Made in Europe



Šifra / art. no.	dužina / length
H07BQ-F ●	
221-141 (EAN 3856024405744)	5 m
221-142 (EAN 3856024405751)	10 m
221-143 (EAN 3856024405768)	20 m
<hr/>	
221-151 (EAN 3856024405775)	5 m
221-152 (EAN 3856024405782)	10 m
221-153 (EAN 3856024405799)	20 m

Made in Europe



Šifra / art. no.	dužina / length
H07RN-F ○	
221-111 (EAN 3858890447897)	5 m
221-112 (EAN 3858890447903)	10 m
221-113 (EAN 3858890447910)	20 m
<hr/>	
221-131 (EAN 3858890447682)	5 m
221-132 (EAN 3858890447699)	10 m
221-133 (EAN 3858890448184)	20 m

Made in Europe



Šifra / art. no.	dužina / length
AT N07V3V3-F ●	
221-101 (EAN 3858890447866)	5 m
221-102 (EAN 3858890447873)	10 m
221-103 (EAN 3858890447880)	20 m

Max. opterećenje / Max. load
16 A / 3500 W

Nazivni napon / Voltage
250 V~

Stupanj zaštite / IP grade
IP44

Kom.kutija / Pcs.ctn.
1



Made in Europe

Max. opterećenje / Max. load
16 A / 3500 W

Nazivni napon / Voltage
250 V~

Stupanj zaštite / IP grade
IP44

Kom.kutija / Pcs.ctn.
1



Made in Europe

H07RN-F
3G1,5

šifra / art. no.	dužina / length
221-301 (EAN 3858890448191)	5 m
221-302 (EAN 3858890448207)	10 m
221-303 (EAN 3858890447927)	20 m

3G2,5

šifra / art. no.	dužina / length
221-321 (EAN 3858890448214)	5 m
221-322 (EAN 3858890448221)	10 m
221-323 (EAN 3858890448238)	20 m

H05RR-F
3G1,5

šifra / art. no.	dužina / length
0658 (EAN 3858883833027)	5 m
0658B (EAN 3858883833348)	25 m

H07RN-F
3G1,5

šifra / art. no.	dužina / length
220-401 (EAN 3858890448245)	5 m
220-402 (EAN 3858890447965)	10 m
220-403 (EAN 3858890447972)	20 m

šifra / art. no.	dužina / length
220-421 (EAN 3858890448252)	5 m
220-422 (EAN 3858890448269)	10 m
220-423 (EAN 3858890448276)	20 m



Made in Europe

AT N07V3V3-F
3G1,5

šifra / art. no.	dužina / length
221-311 (EAN 3858890447934)	5 m
221-312 (EAN 3858890447941)	10 m
221-313 (EAN 3858890447958)	20 m



Made in Europe

AT N07V3V3-F
3G1,5

šifra / art. no.	dužina / length
220-411 (EAN 3858890447989)	5 m
220-412 (EAN 3858890447996)	10 m
220-413 (EAN 3858890448009)	20 m

Značajke
Kabeli s utikačem i natikačem CEE 16A 3P prvenstveno su namijenjeni korištenju u kampovima i marinama za priključivanje kamp kućica i brodova na električnu mrežu. Stupanj zaštite IP44 omogućava korištenje na otvorenom i u vlažnim uvjetima.

Features
Extension cables with CEE 16A 3P plug and socket are primarily intended for use at campsites and in marinas for connecting caravans and boats to the power supply. IP44 degree of protection enables their use outdoors and under humid conditions.

Max. opterećenje / Max. load
16 A / 3500 W

Nazivni napon / Voltage
250 V~

Kom.kutija / Pcs.ctn.
1



Made in Europe

H07BQ-F

3G1,5

šifra / art. no.	dužina / length	stupanj zaštite / IP grade
220-321 (EAN 3856024405683)	5 m	IP44
220-322 (EAN 3856024405690)	10 m	IP44
220-323 (EAN 3856024405706)	20 m	IP44

3G2,5

šifra / art. no.	dužina / length	stupanj zaštite / IP grade
220-331 (EAN 3856024405713)	5 m	IP54
220-332 (EAN 3856024405720)	10 m	IP54
220-333 (EAN 3856024405737)	20 m	IP54



Made in Europe

H07RN-F

3G1,5

šifra / art. no.	dužina / length	stupanj zaštite / IP grade
220-301 (EAN 3858890448016)	5 m	IP44
220-302 (EAN 3858890448023)	10 m	IP44
220-303 (EAN 3858890448030)	20 m	IP44

3G2,5

šifra / art. no.	dužina / length	stupanj zaštite / IP grade
220-311 (EAN 3858890448047)	5 m	IP54
220-312 (EAN 3858890448054)	10 m	IP54
220-313 (EAN 3858890448061)	20 m	IP54

Značajke

H07BQ-F – izvrsna otpornost na mehanička opterećenja, habanje, vremenske prilike, vodu, ulja i masti. Visoka fleksibilnost pri temperaturama do -40°C. Mogućnost upotrebe na visokim temperaturama okoline do +90°C.

Features

H07BQ-F – excellent resistance to mechanical and tear stress, weather conditions, water, oils and greases. High flexibility at temperatures low as -40°C. Can be used at high ambient temperatures up to +90°C.

Max. opterećenje / Max. load
16 A / 3500 W

Nazivni napon / Voltage
250 V~

Kom.kutija / Pcs.ctn.
1



Made in Europe

AT N07V3V3-F

3G1,5

šifra / art. no.	dužina / length	stupanj zaštite / IP grade
220-701 (EAN 3858890448078)	5 m	IP44
220-702 (EAN 3858890448085)	10 m	IP44
220-704 (EAN 3858890444575)	20 m	IP44

3G2,5

šifra / art. no.	dužina / length	stupanj zaštite / IP grade
220-761 (EAN 3858890448092)	5 m	IP54
220-762 (EAN 3858890448108)	10 m	IP54
220-764 (EAN 3858890444605)	20 m	IP54

Max. opterećenje / Max. load
16 A / 9500 W

Nazivni napon / Voltage
400 V~

Kom.kutija / Pcs.ctn.
1



H07RN-F

5G2,5

šifra / art. no.	dužina / length	stupanj zaštite / IP grade
221-901 (EAN 3858890448115)	1.5 m	IP44

Made in Europe

Značajke

AT N07V3V3-F produžni kabele namijenjeni su za otežane uvjete korištenja kao što su na gradilištima, u industriji, brodogradnji i sl. Prednost AT N07V3V3-F kabela u odnosu na standardne PVC kabele je pojačana otpornost na mehanička oštećenja, vodu, ulja, kemikalije te fleksibilnost do -35°C. Prednost u odnosu na gumene kabele je niža cijena finalnog proizvoda.

Features

AT N07V3V3-F connection cables are designed for operating at heavy-duty conditions such as those on construction sites, in industry, shipbuilding, etc. The advantage of AT N07V3V3-F cables over standard PVC cables is enhanced resistance to mechanical damage, water, oil, chemicals and greater flexibility - up to -35°C. The advantage of AT N07V3V3-F cables over rubber cables is lower price of a final product.

**ADAPTER ZA PRETVARANJE CEE STANDARDA U ŠUKO STANDARD /
PLUG ADAPTER FOR CONVERTING CEE TO SCHUKO STANDARD**

Max. opterećenje / Max. load	Nazivni napon / Voltage	Stupanj zaštite / IP grade	Kom.kutija / Pcs.ctn.
16 A / 3500 W	250 V~	IP44	10



Made in Europe

šifra / art. no.	kabel / cable	presjek kabela / cable cross section	dužina / length
221-212 (EAN 3858890448290)	H07RN-F	3G1,5	1,5 m

**ADAPTER ZA PRETVARANJE ŠUKO STANDARDA U CEE STANDARD /
PLUG ADAPTER FOR CONVERTING SCHUKO TO CEE STANDARD**



Made in Europe

šifra / art. no.	kabel / cable	presjek kabela / cable cross section	dužina / length
221-202 (EAN 3858890448283)	H07RN-F	3G1,5	1,5 m

**SIGURNOSNI PRODUŽNI KABEL SA STRUJNOM ZAŠTITNOM SKLOPKOM /
SAFETY EXTENSION CABLE WITH RCD SWITCH**

Max. opterećenje / Max. load	Nazivni napon / Voltage	Stupanj zaštite / IP grade	Kom.kutija / Pcs.ctn.
16 A	250 V~	IP20	1



Made in Europe

šifra / art. no.	kabel / cable	presjek kabela / cable cross section	diferencijalna struja / tripping current	dužina / length
222-201 (EAN 3858890448122)	H07RN-F	3G1,5	30 mA	1,5 m

Značajke: **Zaštita od ponovnog uključivanja nakon nestanka struje.**
Features: **With anti-restart protection after a power interruption occurs.**

**SIGURNOSNI PRODUŽNI KABEL SA STRUJNOM ZAŠTITNOM SKLOPKOM /
SAFETY EXTENSION CABLE WITH RCD SWITCH**



Made in Europe

šifra / art. no.	kabel / cable	presjek kabela / cable cross section	diferencijalna struja / tripping current	dužina / length
222-101 (EAN 3858890448139)	H07RN-F	3G1,5	30 mA	1,5 m

Značajke: **Zaštita od ponovnog uključivanja nakon nestanka struje.**
Features: **With anti-restart protection after a power interruption occurs.**



Max. opterećenje / Max. load **16 A / 3500 W** Nazivni napon / Voltage **250 V~** Stupanj zaštite / IP grade **IP44** Kom.kutija / Pcs.ctn. **1**



Made in Europe



Upotreba u marinama
Suitable for use in Marinas



Upotreba u ribogojilištima
Suitable for use in Fish Farms



Upotreba za električni priključak plovila
Boat electrical connection

MarinFlex 3G1,5

šifra / art. no. dužina / length

221-331 **5 m**
(EAN 3858890449631)

221-332 **10 m**
(EAN 3858890449648)

221-333 **20 m**
(EAN 3858890449655)

Značajke

Features

Commel MARINKO grupa proizvoda je opremljena specijalnim MarinFlex kabelom otpornim na abrazivna djelovanja morske vode.

The Commel MARINKO product group is equipped with a special MarinFlex cable resistant to the abrasive action of sea water.

MarinFlex kabel moguće je koristiti u uvjetima trajnog ili povremenog kontakta s morskom vodom, a odlikuju ga izvrsna fleksibilnost i otpornost na visoke i niske temperature.

The MarinFlex cable can be used in conditions of permanent or occasional contact with sea water, and it has excellent flexibility and resistance to high and low temperatures. It is especially suitable for the electrical connection of boats in the marinas because it is easy to maintain, easy to clean and leaves no traces on the surfaces.

Posebno je pogodan za električni priključak plovila u marinama jer je jednostavan za održavanje, lako se čisti i ne ostavlja tragove na površinama.

ADAPTER ZA PRETVARANJE CEE STANDARDA U ŠUKO STANDARD /
PLUG ADAPTER FOR CONVERTING CEE TO SCHUKO STANDARD

Max. opterećenje / Max. load **16 A / 3500 W** Nazivni napon / Voltage **250 V~** Stupanj zaštite / IP grade **IP44** Kom.kutija / Pcs.ctn. **1**



Made in Europe

MarinFlex 3G1,5

šifra / art. no. dužina / length
221-213 **1.5 m**
(EAN 3858890449679)

ADAPTER ZA PRETVARANJE ŠUKO STANDARDA U CEE STANDARD /
PLUG ADAPTER FOR CONVERTING SCHUKO TO CEE STANDARD

Max. opterećenje / Max. load **16 A / 3500 W** Nazivni napon / Voltage **250 V~** Stupanj zaštite / IP grade **IP44** Kom.kutija / Pcs.ctn. **1**



Made in Europe

MarinFlex 3G1,5

šifra / art. no. dužina / length
221-203 **1.5 m**
(EAN 3858890449662)





HOBBY LINE

PRODUŽNI KABELE EXTENSION CABLES

Max. opterećenje / Max. load
16 A / 10500 W

Nazivni napon / Voltage
400 V~

Stupanj zaštite / IP grade
IP44

Kom.kutija / Pcs.ctn.
1



Made in Europe

H05VV-F
5G1,5

šifra / art. no.	dužina / length
221-121 (EAN 3858890448146)	5 m
0744 (EAN 3858883834277)	10 m
221-123 (EAN 3858890448153)	20 m

Max. opterećenje / Max. load
16 A / 3500 W

Nazivni napon / Voltage
250 V~

Stupanj zaštite / IP grade
IP44

Kom.kutija / Pcs.ctn.
1

Made in Europe



H05RR-F
3G1,5

šifra / art. no.	dužina / length	šifra / art. no.	dužina / length
0644 (EAN 3858883831672)	5 m	0650 (EAN 3859888761728)	5 m
0645 (EAN 3858883831696)	10 m	0651 (EAN 3859888761742)	10 m
0647 (EAN 3858883831733)	20 m	0652 (EAN 3859888761766)	20 m

Značajke

H05RR-F – oznaka označava gumeni kabel. Glavna prednost u odnosu na PVC kabel je puno veća fleksibilnost, pogotovo na temperaturama ispod 0°C.

Features

H05RR-F - mark for a rubber cable. Its main advantage over a PVC cable is much greater flexibility, especially at temperatures below 0°C.

Max. opterećenje / Max. load
10 A / 10500 W

Nazivni napon / Voltage
250 V~

Stupanj zaštite / IP grade
IP20

Kom.kutija / Pcs.ctn.
1

Made in Europe



H05VV-F 3G1

šifra / art. no. dužina / length

220-110 (EAN 3858890448160)	10 m
220-115 (EAN 3858883836080)	15 m
0872A (EAN 3858883830637)	20 m
0872 (EAN 3858883830248)	25 m

Max. opterećenje / Max. load
16 A / 3500 W

Nazivni napon / Voltage
250 V~

Stupanj zaštite / IP grade
IP20

Kom.kutija / Pcs.ctn.
1

Made in Europe



H05VV-F 3G2,5

šifra / art. no. dužina / length

220-151 (EAN 3858890449402)	5 m
220-152 (EAN 3858890449419)	10 m
220-153 (EAN 3858890449426)	15 m

Max. opterećenje / Max. load
16 A / 3500 W

Nazivni napon / Voltage
250 V~

Stupanj zaštite / IP grade
IP20

Kom.kutija / Pcs.ctn.
1

Made in Europe



H05VV-F 3G1,5

šifra / art. no. dužina / length

220-205 (EAN 3858890449778)	5 m
220-210 (EAN 3858890449785)	10 m
220-215 (EAN 3858890440713)	15 m
220-220 (EAN 3858890440720)	20 m
0871 (EAN 3858883830224)	25 m
220-230 (EAN 3858890449792)	30 m

Max. opterećenje / Max. load
16 A / 3500 W

Nazivni napon / Voltage
250 V~

Stupanj zaštite / IP grade
IP20

Kom.kutija / Pcs.ctn.
1

Made in Europe



H05RR-F 3G1,5
3G2,5

220-171 (EAN 3858890449464)	5 m
220-172 (EAN 3858890449471)	10 m
220-173 (EAN 3858890449488)	20 m
220-181 (EAN 3858890449433)	5 m
220-182 (EAN 3858890449440)	10 m
220-183 (EAN 3858890449457)	20 m



Max. opterećenje / Max. load **16 A / 3500 W** Nazivni napon / Voltage **250 V~** Stupanj zaštite / IP grade **IP20** Kom.kutija / Pcs.ctn. **10**

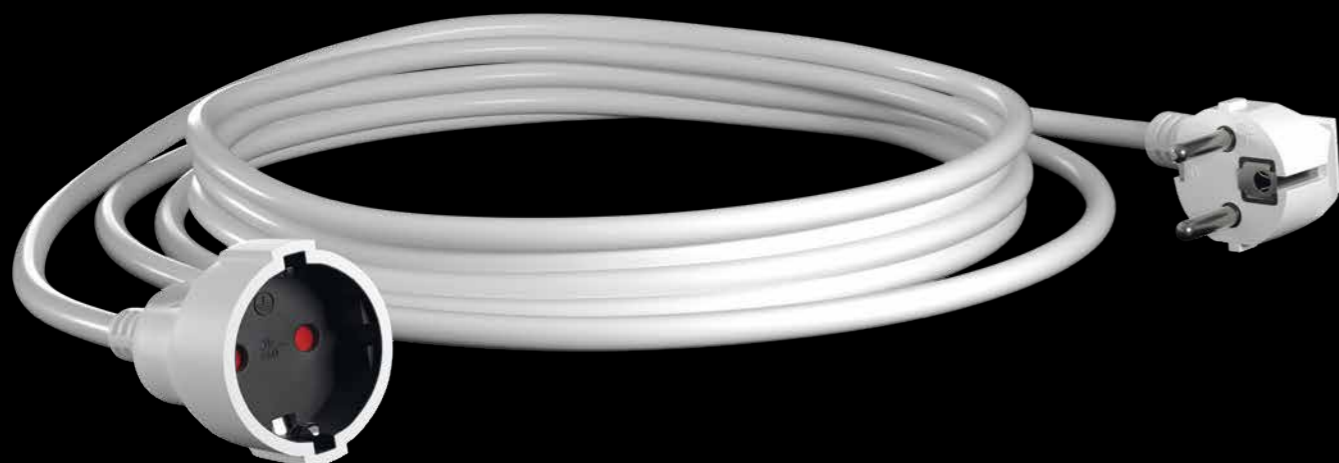

H05VV-F

šifra / art. no.	presjek kabela / cable cross section	dužina / length
220-502X (EAN 3856024407540)	3G1	2 m
220-504X (EAN 3856024407557)	3G1,5	4 m
220-508X (EAN 3856024407564)	3G1,5	8 m

Značajke

Features

Bijeli produžni kabeli s PVC plaštom namijenjeni su kućnoj upotrebi. Maksimalno opterećenje od 16 A omogućava priključivanje aparata snage do 3500 W. Utičnice su opremljene zaštitom od kontakta (Zaštita od direktnog kontakta).

White connection cables with PVC sheath are intended for home use. The maximum load of 16 A allows you to manage appliances with power up to 3500 W. The sockets are equipped with contact protection (Direct contact protection).

Max. opterećenje / Max. load **16 A / 3500 W** Nazivni napon / Voltage **250 V~** Stupanj zaštite / IP grade **IP20** Kom.kutija / Pcs.ctn. **10**



H05VV-F

šifra / art. no.	presjek kabela / cable cross section	dužina / length
220-522X (EAN 3856024407571)	3G1	2 m
220-524X (EAN 3856024407588)	3G1,5	4 m
220-528X (EAN 3856024407595)	3G1,5	8 m

Max. opterećenje / Max. load **2,5 A / 500 W** Nazivni napon / Voltage **250 V~** Stupanj zaštite / IP grade **IP20** Kom.kutija / Pcs.ctn. **20**



H03VVH2-F
2x0,75

šifra / art. no.	dužina / length
223-101 (EAN 3858890445985)	2 m
223-102 (EAN 3858890448177)	4 m

ZAŠTITNA KUTIJA ZA SPAJANJE KABELA / SAFE BOX FOR CABLE CONNECTION



šifra / art. no. **366-101**
(EAN 3858890441703) stupanj zaštite / IP grade **IP44**

Značajke

Features

Omogućava vodootporni spoj, sprječava razdvajanje utikača od utičnice, mogućnost montaže na zid, 5 kopči za sigurno zatvaranje

Allows a waterproof connection, prevents unplugging, possibility of mounting on the wall, 5 clips for safe closing

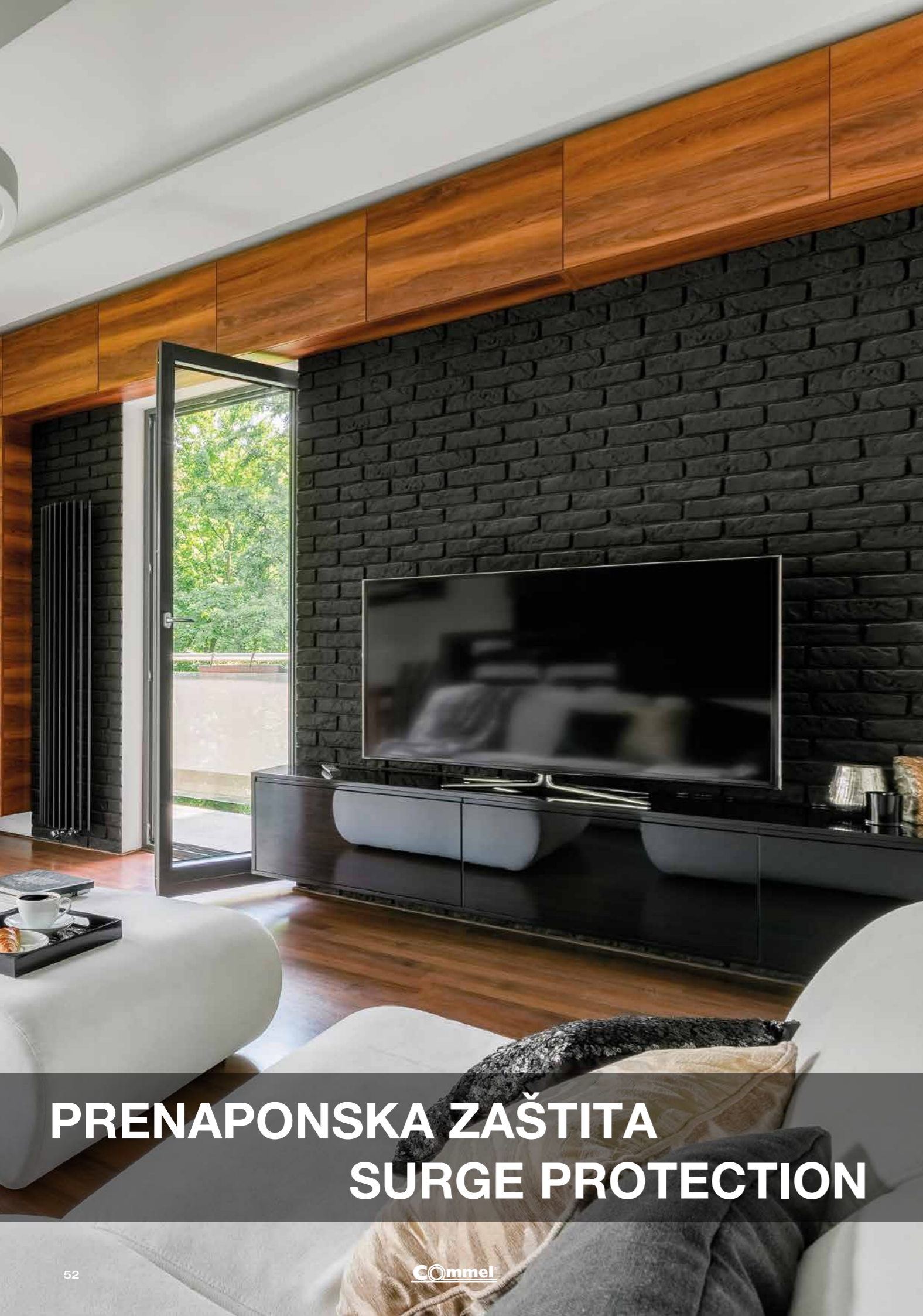

PRENAPONSKA ZAŠTITA SURGE PROTECTION

Kabel / Cable
H05VV-F 3G1,5

Nazivni napon / Voltage
250 V~

Max. opterećenje / Max. load
16 A / 3500 W

Kom.kutija / Pcs.ctn.
10



šifra / art. no.
380-107
(EAN 3856024403757)

utičnice / sockets

USB

dužina / length

8 x 230 V ~ / 16 A 5V DC 2,1 A 3 m

Značajke

Zaštita od preopterećenja (termoprekidač) – prekida strujni krug u slučaju pregrijavanja utičnice uzrokovanog priključivanjem aparata ukupne snage veće od 3500 W

Zaštita od prenapona – štiti priključene uređaje od prenapona uzrokovanog udarom groma u električnu mrežu
8 šuko utičnice + 2 USB punjača

Features

Overload protection (thermo switch) – cuts off electric current in case of overheating of the socket outlet caused by plugging in appliances with total power greater than 3500 W

Surge protection - protects the appliances against electrical surges and spikes, including those caused by lightning
8 Schuko sockets + 2 USB chargers

Kabel / Cable
H05VV-F 3G1,5

Nazivni napon / Voltage
250 V~

Max. opterećenje / Max. load
16 A / 3500 W

Kom.kutija / Pcs.ctn.
40



šifra / art. no. utičnice / sockets

dužina / length

380-105
(EAN 3858883838800)

6 x 230 V ~ / 16 A 1,5 m

Značajke

Zaštita od prenapona – štiti priključene uređaje od prenapona uzrokovanog udarom groma u električnu mrežu

Features

Surge protection - protects the appliances against electrical surges and spikes, including those caused by lightning

Kabel / Cable
H05VV-F 3G1,5

Nazivni napon / Voltage
250 V~

Max. opterećenje / Max. load
16 A / 3680 W

Kom.kutija / Pcs.ctn.
10



Kabel / Cable
H05VV-F 3G1,5

Nazivni napon / Voltage
250 V~

Max. opterećenje / Max. load
16 A / 3680 W

Kom.kutija / Pcs.ctn.
10

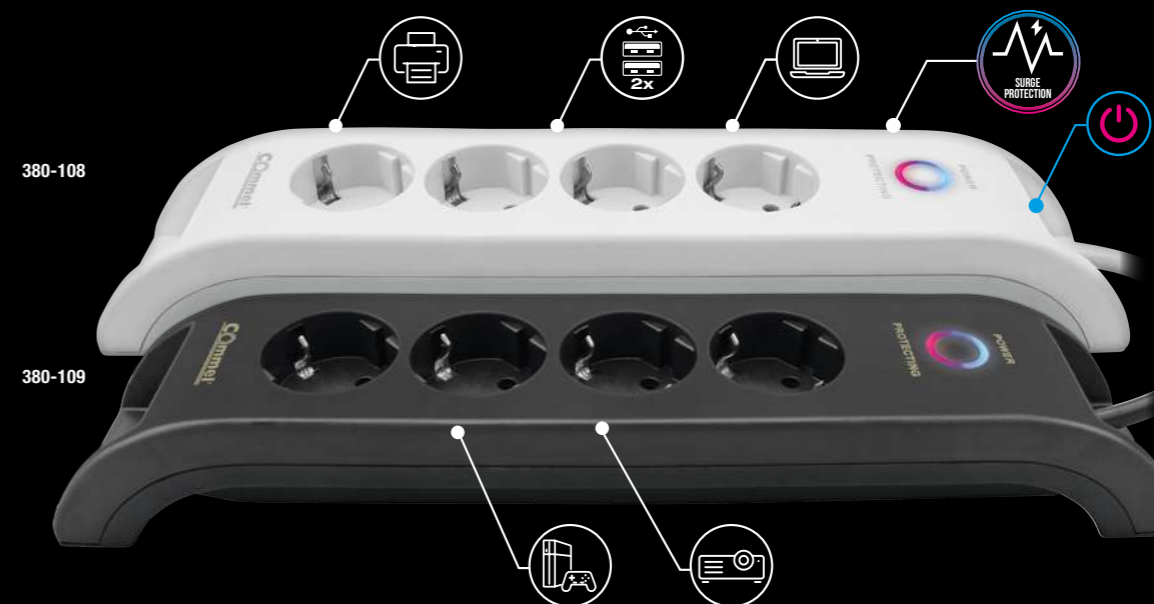

šifra / art. no. utičnice / sockets
380-110
(EAN 3856024405973) **8 x 250 V ~ / 16 A**

USB
2 x 5V DC 2,1 A

dužina / length
2 m

šifra / art. no. utičnice / sockets
380-108
(EAN 3856024405959) **4 x 230 V ~ / 16 A**

USB
2 x 5V DC 2,1 A

dužina / length
2 m



Značajke Features
Zaštita od prenapona – štiti priključene uređaje od prenapona uzrokovanog udarom groma u električnu mrežu
Surge protection - protects the appliances against electrical surges and spikes, including those caused by lightning

Značajke Features
Zaštita od prenapona – štiti priključene uređaje od prenapona uzrokovanog udarom groma u električnu mrežu
Surge protection - protects the appliances against electrical surges and spikes, including those caused by lightning



PRENOSIVE UTIČNICE EXTENSION SOCKETS

Kabel / Cable
H05VV-F

Nazivni napon / Voltage
250 V~

Max. opterećenje / Max. load
16 A / 3500 W

Kom.kutija / Pcs.ctn.
10



Broj utičnica /
Number of sockets

3

šifra / art. no.

0802
(EAN 3859888558014)

0804
(EAN 3859888558021)

0806
(EAN 3859888558038)

0808
(EAN 3859888558045)

presjek kabela /
cable cross section

3G1

3G1,5

3G1,5

3G1,5

dužina kabela /
cabel length

1,4 m

3 m

5 m

10 m



Broj utičnica /
Number of sockets

5

šifra / art. no.

232-501
(EAN 3858883835809)

232-502
(EAN 3858883835465)

232-503
(EAN 3858883835472)

presjek kabela /
cable cross section

3G1

3G1,5

3G1,5

dužina kabela /
cabel length

1,4 m

3 m

5 m

Značajke Features

Zaštita od direktnog kontakta Direct contact protection



Kabel / Cable **H05VV-F** Nazivni napon / Voltage **250 V~** Max. opterećenje / Max. load **16 A / 3500 W** Kom.kutija / Pcs.ctn. **10**

Broj utičnica /
Number of sockets

3

šifra / art. no.	presjek kabela / cable cross section	dužina kabela / cabel length
0814 (EAN 3859889306546)	3G1	1,4 m
0815 (EAN 3858883830415)	3G1,5	3 m
0816 (EAN 3859889306560)	3G1,5	5 m



Broj utičnica /
Number of sockets

5

šifra / art. no.	presjek kabela / cable cross section	dužina kabela / cabel length
0817 (EAN 3859889306522)	3G1	1,4 m
232-504 (EAN 3858883836127)	3G1,5	3 m
232-505 (EAN 3858883836134)	3G1,5	5 m



Broj utičnica /
Number of sockets

6

šifra / art. no.	presjek kabela / cable cross section	dužina kabela / cabel length
0838 (EAN 3859889306607)	3G1	1,4 m
0837 (EAN 3858883830439)	3G1,5	3 m
0839 (EAN 3859889306584)	3G1,5	5 m

Značajke	Features
Zaštita od direktnog kontakta	Direct contact protection
Dvopolna sklopka	Two-pole illuminated switch

Kabel / Cable **H05VV-F** Nazivni napon / Voltage **250 V~** Max. opterećenje / Max. load **2,5 A / 16 A** Kom.kutija / Pcs.ctn. **10**

Broj utičnica / Number of sockets

4 x EURO
4 x ŠUKO / SCHUKO

šifra / art. no.	presjek kabela / cable cross section	dužina kabela / cabel length
0843 (EAN 3859889306621)	3G1	1,4 m



Značajke	Features
Zaštita od direktnog kontakta	Direct contact protection
Dvopolna sklopka	Two-pole illuminated switch

Kabel / Cable **H05VV-F** Nazivni napon / Voltage **250 V~** Max. opterećenje / Max. load **16 A / 3500 W** Kom.kutija / Pcs.ctn. **10**

Broj utičnica /
Number of sockets

3

šifra / art. no.	presjek kabela / cable cross section	dužina kabela / cabel length
232-321 (EAN 3858890446913)	3G1	1,4 m
232-322 (EAN 3858890446920)	3G1,5	3 m
232-323 (EAN 3856024406161)	3G1,5	5 m

Značajke	Features
Zaštita od direktnog kontakta	Direct contact protection

Kabel / Cable **H05VV-F** Nazivni napon / Voltage **250 V~** Max. opterećenje / Max. load **16 A / 3500 W** Kom.kutija / Pcs.ctn. **10**



Broj utičnica / Number of sockets	šifra / art. no. (EAN)	presjek kabela / cable cross section	dužina kabela / cabel length
5	232-521 (EAN 3858890447507)	3G1	1,4 m
	232-522 (EAN 3858890447514)	3G1,5	3 m
	232-523 (EAN 3856024406185)	3G1,5	5 m

Značajke Features
Zaštita od direktnog kontakta **Direct contact protection**

Broj utičnica / Number of sockets	šifra / art. no. (EAN)	presjek kabela / cable cross section	dužina kabela / cabel length
3	232-324 (EAN 3858890446937)	3G1	1,4 m
	232-325 (EAN 3858890446944)	3G1,5	3 m
	232-326 (EAN 3856024406178)	3G1,5	5 m

Broj utičnica / Number of sockets	šifra / art. no. (EAN)	presjek kabela / cable cross section	dužina kabela / cabel length
5	232-524 (EAN 3858890447521)	3G1	1,4 m
	232-525 (EAN 3858890447538)	3G1,5	3 m
	232-526 (EAN 3856024406192)	3G1,5	5 m

Značajke Features
Zaštita od direktnog kontakta **Direct contact protection**
Dvopolna sklopka **Two-pole illuminated switch**

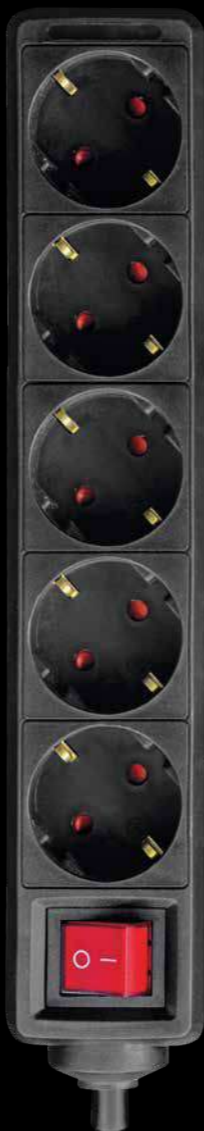

Kabel / Cable **H05VV-F** Nazivni napon / Voltage **250 V~** Max. opterećenje / Max. load **16 A / 3500 W**
USB **5 V DC 2,1 A** Kom.kutija / Pcs.ctn. **10**



Broj utičnica / Number of sockets	šifra / art. no. (EAN)	boja / color	presjek kabela / cable cross section	dužina kabela / cabel length
3	234-401 (EAN 3856024403542)	●	3G1	1,4 m
	234-402 (EAN 3856024403559)	●	3G1,5	3 m
	234-411 (EAN 3856024403566)	○	3G1	1,4 m
	234-412 (EAN 3856024403573)	○	3G1,5	3 m

Značajke Features
Svjetlosni indikator napona **Power indicator light**
3 šuko utičnice + 2 USB punjača **3 Schuko sockets + 2 USB chargers**

Kabel / Cable **H05VV-F 3G1,5** Nazivni napon / Voltage **250 V~** Max. opterećenje / Max. load **16 A / 3500 W** USB **5 V DC 2,1 A** Kom.kutija / Pcs.ctn. **16**

Broj utičnica /
Number of sockets

4

šifra / art. no. (EAN)	dužina kabela / cabel length
234-161 (EAN 3858890446340)	1,4 m



Značajke Features
4 šuko utičnice + 2 USB punjača **4 Schuko sockets + 2 USB chargers**
Svjetlosni indikator napona **Power indicator light**
Nosač za montažu na zid ili stol **Bracket for wall or table mounting**

PRENOSIVA UTIČNICA BEZ KABELA / REWIREABLE EXTENSION SOCKET

Nazivni napon / Voltage
250 V~

Max. opterećenje / Max. load
16 A / 3680 W

Kom.kutija / Pcs.ctn.
10



šifra / art. no.	broj utičnica / number of sockets
232-031 (EAN 3856024406055)	3
232-051 (EAN 3856024406093)	5

Značajke	Features
Zaštita od direktnog kontakta	Direct contact protection
Dva načina pričvršćivanja na zid	Two ways of attaching to the wall

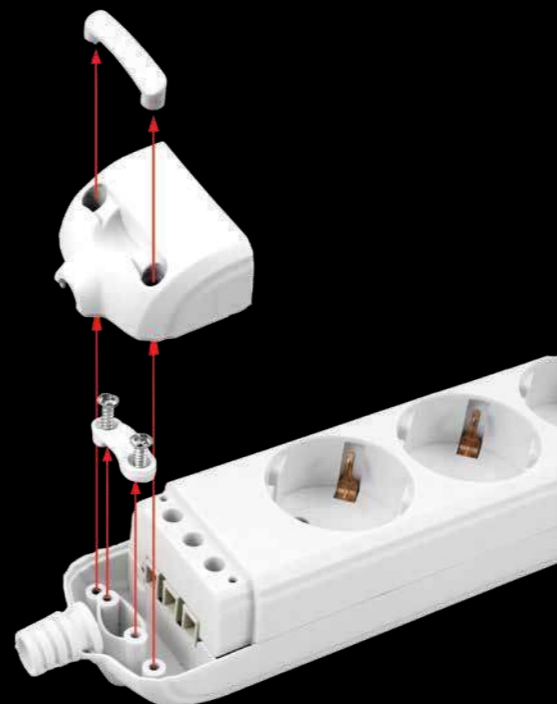

Nazivni napon / Voltage
250 V~

Max. opterećenje / Max. load
16 A / 3680 W

Kom.kutija / Pcs.ctn.
10



šifra / art. no.	broj utičnica / number of sockets
232-035 (EAN 3856024406079)	3
232-055 (EAN 3856024406116)	5

Značajke	Features
Zaštita od direktnog kontakta	Direct contact protection
Dva načina pričvršćivanja na zid	Two ways of attaching to the wall

Nazivni napon / Voltage
250 V~

Max. opterećenje / Max. load
16 A / 3680 W

Kom.kutija / Pcs.ctn.
10



šifra / art. no.	broj utičnica / number of sockets
232-032 (EAN 3856024406062)	3
232-052 (EAN 3856024406109)	5

Značajke	Features
Rastavljiv je samo dio za ožičenje	Only the wiring part is detachable
Dvopolna sklopka	Two-pole illuminated switch
Dva načina pričvršćivanja na zid	Two ways of attaching to the wall



Nazivni napon / Voltage
250 V~

Max. opterećenje / Max. load
16 A / 3680 W

Kom.kutija / Pcs.ctn.
10

šifra / art. no.	broj utičnica / number of sockets
232-036 (EAN 3856024406086)	3
232-056 (EAN 3856024406123)	5

Značajke	Features
Rastavljiv je samo dio za ožičenje	Only the wiring part is detachable
Dvopolna sklopka	Two-pole illuminated switch
Zaštita od direktnog kontakta	Direct contact protection

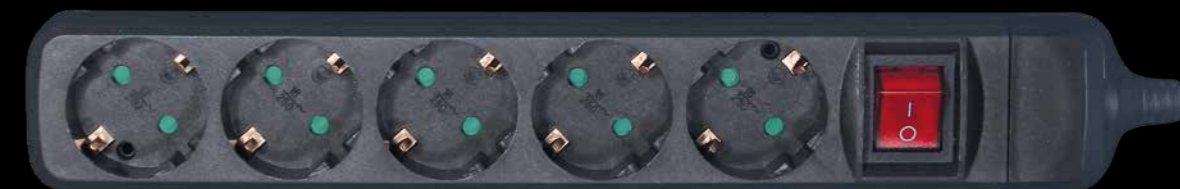



UGRADBENE UTIČNICE ZA NAMJEŠTAJ FURNITURE SOCKETS

Kabel / Cable H05VV-F 3G1,5	Max. opterećenje / Max. load 16 A / 3500 W	Kom.kutija / Pcs.ctn. 20
Nazivni napon / Voltage 220-240 V~ 50/60Hz	Stupanj zaštite/ IP grade IP20	

šifra / art. no.	broj utičnica / number of sockets	USB	dužina/ length
232-181 (EAN 3856024402217)	3	-	1,8 m
234-181 (EAN 3856024402224)	3	2.1 A 5V	1,8 m

Značajke	Features
232-181 Svjetlosni indikator napona 3 šuko utičnice	232-181 Power indicator light 3 Schuko sockets
234-181 Dvopolna sklopka 3 šuko utičnice + 2 USB punjača	234-181 Two-pole illuminated switch 3 Schuko sockets + 2 USB chargers



Kabel / Cable **H05VV-F 3G1,5** Max. opterećenje / Max. load **16 A / 3680 W** Nazivni napon / Voltage **250 V~** Kom.kutija / Pcs.ctn. **10**

Kabel / Cable **H05VV-F 3G1,5** Max. opterećenje / Max. load **16 A / 3680 W** Nazivni napon / Voltage **250 V~** Kom.kutija / Pcs.ctn. **20**

šifra / art. no. broj utičnica / number of sockets USB dužina / length
235-121 **3** **5 V DC 3,1 A max 15.5 W** **2 m**
 (EAN 3856024405904)

Značajke Features
Svjetlosni indikator napona **Power indicator light**
3 šuko utičnice + 2 USB punjača **3 Schuko sockets + 2 USB chargers**
2 dekorativna prstena **2 decorative rings**

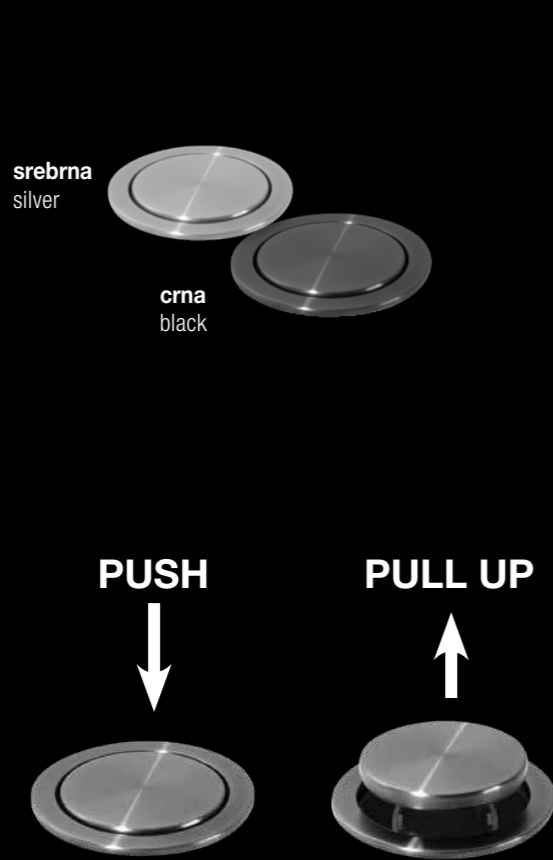
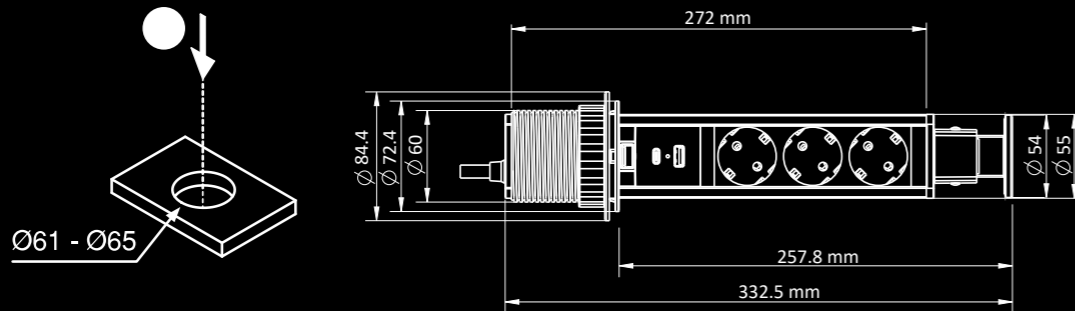

šifra / art. no.	boja / color	broj utičnica / number of sockets	dužina / length
235-111 (EAN 3856024405881)	●	1	2 m
235-112 (EAN 3856024405898)	○	1	2 m

Značajke Features
2 dekorativna prstena **2 decorative rings**

Kabel / Cable **H05VV-F 3G1,5** Max. opterećenje / Max. load **16 A / 3680 W** Nazivni napon / Voltage **250 V~** Kom.kutija / Pcs.ctn. **10**

UTIČNICA ZA RADNI STOL / DESK SOCKET

Kabel / Cable **H05VV-F 3G1,5** Max. opterećenje / Max. load **16 A / 3680 W** Nazivni napon / Voltage **230 V~** Kom.kutija / Pcs.ctn. **12**

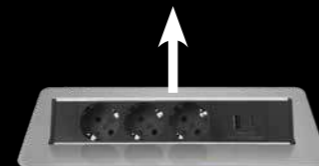
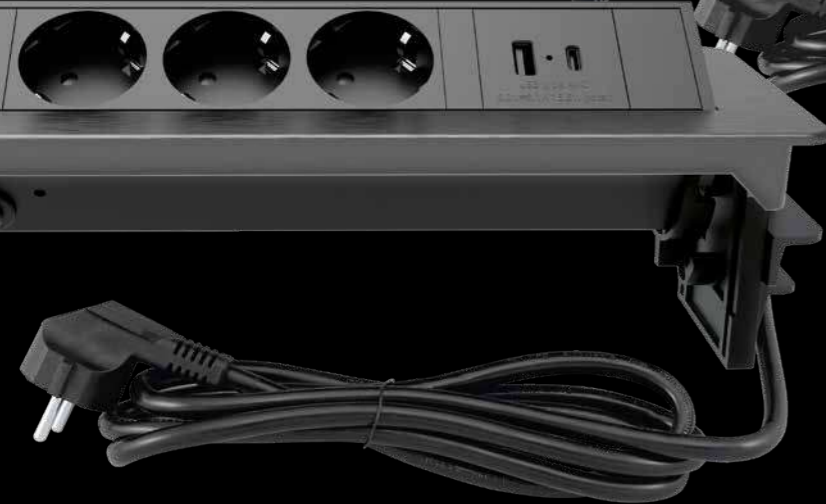
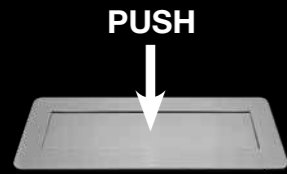

šifra / art. no. broj utičnica / number of sockets USB dužina / length
235-130 **3** **5 V DC 3,4 A max 17 W** **1,4 m**
 (EAN 3856024407410)

šifra / art. no. broj utičnica / number of sockets boja / color USB dužina / length
235-101 **3** **nikal / nickel** **5 V DC 3,1 A max 15.5 W** **2 m**
 (EAN 3856024405867)
235-102 **3** **crna / black** **5 V DC 3,1 A max 15.5 W** **2 m**
 (EAN 3856024405874)

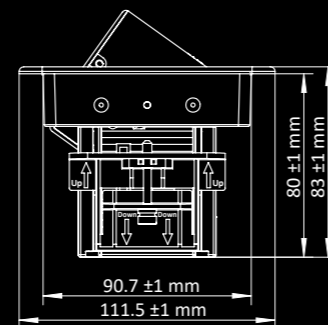
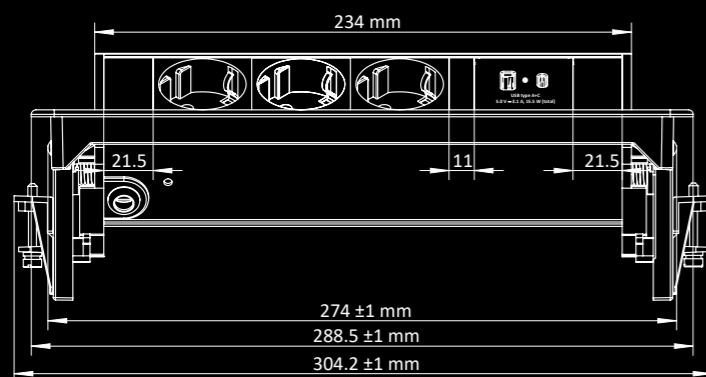
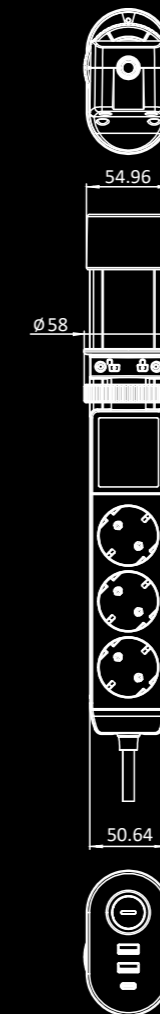
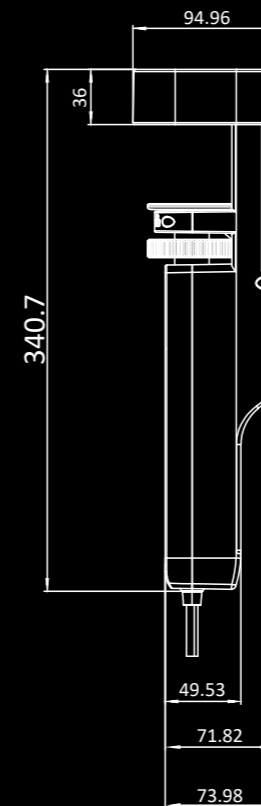

Značajke Features
 Brzi sistem ugradnje Fast mounting system



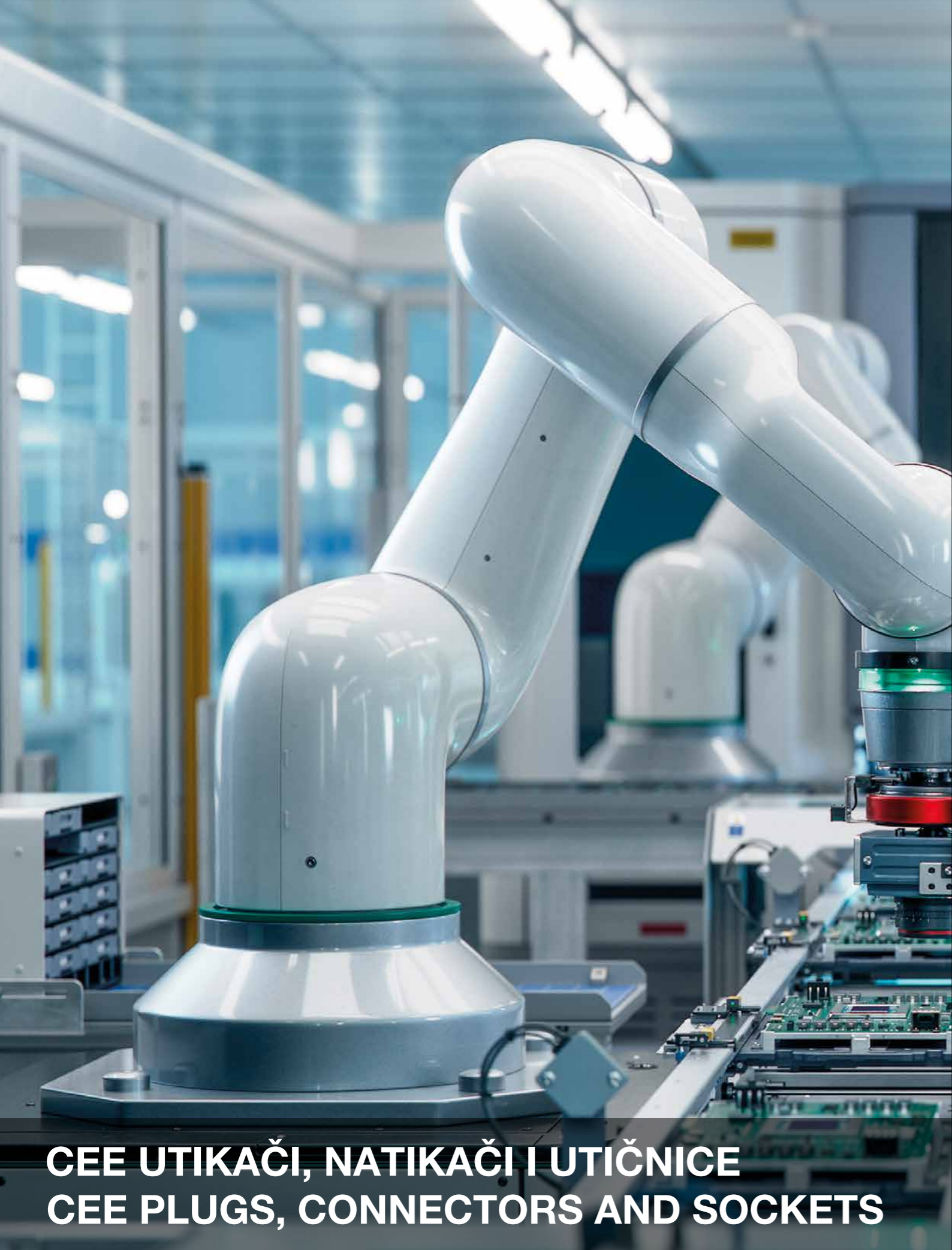

CEE UTIKAČI, NATIKAČI I UTIČNICE CEE PLUGS, CONNECTORS AND SOCKETS

Nazivni napon / Voltage
400 V~ Kom.kutija / Pcs.ctn.
1

šifra / art. no.	max. opterećenje / max. load	polovi / poles	stupanj zaštite / IP grade
280-101 (EAN 3858890444100)	16 A	4P	IP44
280-102 (EAN 3858890444117)	32 A	4P	IP44
280-103 (EAN 3858890444124)	16 A	5P	IP44
280-104 (EAN 3858890444131)	32 A	5P	IP44



280-105 (EAN 3858890444148)	63 A	5P	IP44
---------------------------------------	-------------	-----------	-------------



280-301 (EAN 3858890444278)	16 A	5P	IP44
280-302 (EAN 3858890444285)	32 A	5P	IP44



šifra / art. no.	max. opterećenje / max. load	polovi / poles	stupanj zaštite / IP grade
280-113 (EAN 3856024403863)	16 A	5P	IP67
280-114 (EAN 3856024403870)	32 A	5P	IP67





	Nazivni napon / Voltage	Kom.kutija / Pcs.ctn.		
	400 V~	1		
šifra / art. no.	max. opterećenje / max. load	polovi / poles	stupanj zaštite / IP grade	
281-101 (EAN 3858890444155)	16 A	4P	IP44	
281-102 (EAN 3858890444162)	32 A	4P	IP44	
281-103 (EAN 3858890444179)	16 A	5P	IP44	
281-104 (EAN 3858890444186)	32 A	5P	IP44	



281-105 (EAN 3858890444193)	63 A	5P	IP44	
---------------------------------------	-------------	-----------	-------------	--



280-113 (EAN 3856024403887)	16 A	5P	IP67	
280-114 (EAN 3856024403894)	32 A	5P	IP67	



šifra / art. no.	max. opterećenje / max. load	polovi / poles	stupanj zaštite / IP grade	
282-501 (EAN 3858890444209)	16 A	4P	IP44	
282-502 (EAN 3858890444216)	32 A	4P	IP44	
282-503 (EAN 3858890444223)	16 A	5P	IP44	
282-504 (EAN 3858890444230)	32 A	5P	IP44	

	Nazivni napon / Voltage	Kom.kutija / Pcs.ctn.		
	400 V~	1		
šifra / art. no.	max. opterećenje / max. load	polovi / poles	stupanj zaštite / IP grade	
282-505 (EAN 3858890444247)	63 A	5P	IP44	



	Nazivni napon / Voltage	Kom.kutija / Pcs.ctn.		
	400 V~	1		

šifra / art. no.	max. opterećenje / max. load	polovi / poles	stupanj zaštite / IP grade	
280-501 (EAN 3858890444254)	16 A	5P	IP44	
280-502 (EAN 3858890444261)	32 A	5P	IP44	



	Nazivni napon / Voltage	Kom.kutija / Pcs.ctn.		
	250/400 V~	1		

šifra / art. no.	max. opterećenje / max. load	polovi / poles	stupanj zaštite / IP grade	
282-551 (EAN 3858890444292)	16 A	5P	IP44	



	Nazivni napon / Voltage	Kom.kutija / Pcs.ctn.		
	400 V~	1		

šifra / art. no.	max. opterećenje / max. load	polovi / poles	stupanj zaštite / IP grade	
282-301 (EAN 3858890444308)	16 A	5P	IP44	
282-302 (EAN 3856024406758)	32 A	5P	IP44	





	Nazivni napon / Voltage 250 V~			Kom.kutija / Pcs.ctn. 1
šifra / art. no. 280-201 (EAN 3858890444315)	max. opterećenje / max. load 16 A	polovi / poles 3P	stupanj zaštite / IP grade IP44	
šifra / art. no. 280-202 (EAN 3856024400145)	max. opterećenje / max. load 32 A	polovi / poles 3P	stupanj zaštite / IP grade IP44	



	Nazivni napon / Voltage 250 V~			Kom.kutija / Pcs.ctn. 1
šifra / art. no. 280-211 (EAN 3856024403900)	max. opterećenje / max. load 16 A	polovi / poles 3P	stupanj zaštite / IP grade IP67	



	Nazivni napon / Voltage 250 V~			Kom.kutija / Pcs.ctn. 10
šifra / art. no. 281-201 (EAN 3858890444322)	max. opterećenje / max. load 16 A	polovi / poles 3P	stupanj zaštite / IP grade IP44	
šifra / art. no. 281-202 (EAN 3856024400152)	max. opterećenje / max. load 32 A	polovi / poles 3P	stupanj zaštite / IP grade IP44	



	Nazivni napon / Voltage 250 V~			Kom.kutija / Pcs.ctn. 1
šifra / art. no. 281-211 (EAN 3856024403917)	max. opterećenje / max. load 16 A	polovi / poles 3P	stupanj zaštite / IP grade IP67	



	Nazivni napon / Voltage 250 V~			Kom.kutija / Pcs.ctn. 1
šifra / art. no. 282-511 (EAN 3858890444339)	max. opterećenje / max. load 16 A	polovi / poles 3P	stupanj zaštite / IP grade IP44	
šifra / art. no. 282-512 (EAN 3856024406130)	max. opterećenje / max. load 32 A	polovi / poles 3P	stupanj zaštite / IP grade IP44	

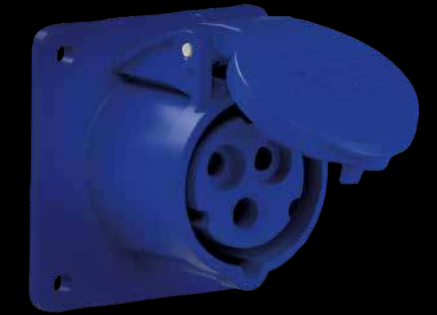

	Nazivni napon / Voltage 250 V~			Kom.kutija / Pcs.ctn. 1
šifra / art. no. 282-311 (EAN 3858890444346)	max. opterećenje / max. load 16 A	polovi / poles 3P	stupanj zaštite / IP grade IP44	

Nazivni napon / Voltage
250 V~

	Nazivni napon / Voltage 250 V~			Kom.kutija / Pcs.ctn. 10
šifra / art. no. 284-101 (EAN 3856024403405)	max. opterećenje / max. load 16 A	polovi / poles 3P	stupanj zaštite / IP grade IP20	

Adapter za pretvaranje CEE standarda u šuko+talijanski standard

Plug adapter for converting CEE to Schuko+Italian standard



	Nazivni napon / Voltage 250 V~			Kom.kutija / Pcs.ctn. 1
šifra / art. no. 284-102 (EAN 3856024403412)	max. opterećenje / max. load 16 A	polovi / poles 3P	stupanj zaštite / IP grade IP20	

Adapter za pretvaranje šuko standarda u CEE standard.

Plug adapter for converting Schuko to CEE standard

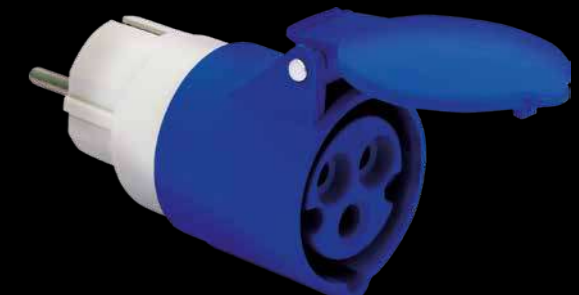



UTIKAČI, NATIKAČI I UTIČNICE PLUGS, CONNECTORS AND SOCKETS

EURO



šifra / art. no. boja / color
290-601 ●
 (EAN 3858890442670)
290-602 ○
 (EAN 3858890442687)

Nazivni napon /
Voltage
250 V~

Max. opterećenje /
Max. load
2,5 A



šifra / art. no. boja / color
291-601 ●
 (EAN 3858890442694)
291-602 ○
 (EAN 3858890442700)

Stupanj zaštite /
IP grade
IP20

Kom.kutija /
Pcs.ctn.
10

ŠUKO / SCHUKO



šifra / art. no. boja / color
290-101 ●
 (EAN 3858883833928)
290-102 ○
 (EAN 3858883833935)

Nazivni napon /
Voltage
250 V~

Max. opterećenje /
Max. load
16 A



šifra / art. no. boja / color
290-201 ●
 (EAN 3858883833942)
290-202 ○
 (EAN 3858883833959)

Stupanj zaštite /
IP grade
IP20

Kom.kutija /
Pcs.ctn.
10

ŠUKO / SCHUKO



šifra / art. no. boja / color
291-101 ●
 (EAN 3858883833966)
291-102 ○
 (EAN 3858883833973)

Nazivni napon / Voltage
250 V~

Max. opterećenje / Max. load
16 A

Stupanj zaštite / IP grade
IP20

Kom.kutija / Pcs.ctn.
10



šifra / art. no. boja / color
291-201 ●
 (EAN 3858883833980)
291-202 ○
 (EAN 3858883833997)

Nazivni napon / Voltage
250 V~

Max. opterećenje / Max. load
16 A

Stupanj zaštite / IP grade
IP20

Kom.kutija / Pcs.ctn.
10



šifra / art. no. boja / color
290-501 ●
 (EAN 3858890442625)
290-502 ○
 (EAN 3858890442649)

Stupanj zaštite / IP grade
IP20

Kom.kutija / Pcs.ctn.
10



PLOSNATI / FLAT

PROFI SERIJA / PROFESSIONAL SERIES

Nazivni napon / Voltage
250 V~

Max. opterećenje / Max. load
16 A



Stupanj zaštite / IP grade
IP54

šifra / art. no. kom.kutija / pcs.ctn.
290-308 30
 (EAN 3856024402293)



Stupanj zaštite / IP grade
IP20

šifra / art. no. kom.kutija / pcs.ctn.
291-308 20
 (EAN 3856024402309)



Stupanj zaštite / IP grade
IP54

šifra / art. no. kom.kutija / pcs.ctn.
291-309 20
 (EAN 3856024402316)

Nazivni napon / Voltage
250 V~

Max. opterećenje / Max. load
16 A

Stupanj zaštite / IP grade
IP44

Kom.kutija / Pcs.ctn.
10

šifra / art. no.
290-302
 (EAN 3858883831450)



šifra / art. no.
291-302
 (EAN 3858883831467)





PROFESSIONAL SERIES

Nazivni napon / Voltage
250 V~

Max. opterećenje / Max. load
16 A

Kom.kutija / Pcs.ctn.
10

šifra / art. no.
290-311
(EAN 3856024407366)

stupanj zaštite /
IP grade
IP44



Nazivni napon / Voltage
400 V~

Stupanj zaštite / IP grade
IP20

Max. opterećenje / Max. load
16 A

Kom.kutija / Pcs.ctn.
20

šifra / art. no.
6350
(EAN 3858883838015)



šifra / art. no.
291-311
(EAN 3856024407373)

stupanj zaštite /
IP grade
IP20



Nazivni napon / Voltage
250 V~

Max. opterećenje / Max. load
16 A

Kom.kutija / Pcs.ctn.
1

šifra / art. no.
292-101
(EAN 3858890444469)

stupanj zaštite /
IP grade
IP54



šifra / art. no.
291-312
(EAN 3856024407380)

stupanj zaštite /
IP grade
IP44



Nazivni napon / Voltage
250 V~

Max. opterećenje / Max. load
2,5 A

Kom.kutija / Pcs.ctn.
10

šifra / art. no.
293-701
(EAN 3858890445466)

293-702
(EAN 3858890445473)

boja / color
●
○





RAZDJELNICI, ADAPTERI I PUNJAČI ADAPTORS AND CHARGERS

Nazivni napon /Voltage
230 V~ 50 Hz

Boja / Color
●



šifra / art. no.	broj utičnica / number of sockets	max. opterećenje / max. load	kom.kutija / pcs.ctn.
240-121 (EAN 3856024408158)	2	2 x 16 A	48
240-122 (EAN 3856024408165)	3	3 x 16 A	48



šifra / art. no.	broj utičnica / number of sockets	max. opterećenje / max. load	kom.kutija / pcs.ctn.
240-802 (EAN 3856024408172)	2 + USB USB - A+C, max 20.0 W	2 x 16 A	12

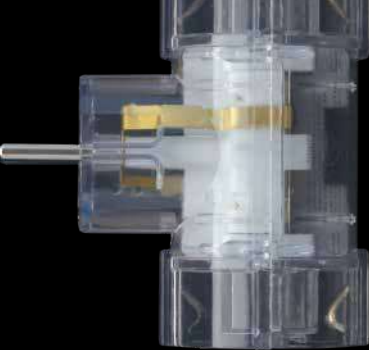

Max. opterećenje / Max. load
16 A / 3500 W

Nazivni napon / Voltage
250 V~

Kom.kutija / Pcs.ctn.
10



Broj utičnica /
Number of sockets

2

šifra / art. no. boja / color

6338-1
(EAN 3858883838404) ●

6338-2
(EAN 3858883838411) ○

240-103
(EAN 3858890448313) ●



Broj utičnica /
Number of sockets

3

šifra / art. no. boja / color

6338-3
(EAN 3858883838428) ●

6338-4
(EAN 3858883838435) ○

240-113
(EAN 3858890448320) ●



Max. opterećenje / Max. load
2,5 A / 16 A

Nazivni napon / Voltage
250 V~

Kom.kutija / Pcs.ctn.
10

Broj utičnica /
Number of sockets

3

šifra / art. no. boja / color

49111-1
(EAN 3858883838541) ●

49112-2
(EAN 3858883838510) ○



Nazivni napon /Voltage
250 V~

Kom.kutija / Pcs.ctn.
10

Boja / Color
●

šifra / art. no.

240-301
(EAN 3858890441512)

240-302
(EAN 3858890441505)

240-303
(EAN 3858890441499)

broj utičnica /
number of sockets

1

2

3

max. opterećenje /
max. load

16 A

16 A

2,5 A / 16 A



Nazivni napon /Voltage
250 V~

Kom.kutija / Pcs.ctn.
10

Boja / Color
●

šifra / art. no.

240-306
(EAN 3856024402927)

broj utičnica /
number of sockets

3

max. opterećenje /
max. load

2,5 A / 16 A



UTIČNICA S USB PUNJAČEM / SOCKET WITH USB CHARGER

Max. opterećenje / Max. load
16 A / 3680 W

Nazivni napon / Voltage
250 V~ 50 Hz

Stupanj zaštite / IP Grade
IP20

Kom.kutija / Pcs.ctn.
50



šifra / art. no.

240-801
(EAN 3856024406147)

broj šuko utičnica /
number of schuko sockets

1

USB A+C

5 V $\overline{\text{---}}$ 3,4 A max 17 W



UTIČNICA S USB PUNJAČEM / SOCKET WITH USB CHARGER



Nazivni napon / Voltage
110-250 V~ 50/60 Hz, 390 mA

Stupanj zaštite / IP Grade
IP20

Kom.kutija / Pcs.ctn.
60

šifra / art. no. kabel / cable

dužina kabla / cable length

USB A+C

245-101
(EAN 3856024406154)

H03VVH2-F

1,5 m

5 V $\overline{\text{---}}$ 3,4 A max 17,5 W



UNIVERZALNI PUTNI ADAPTER 250 V / TRAVEL ADAPTER 250 V

Nazivni napon / Voltage
250 V~

Max. opterećenje / Max. load
10 A

Kom.kutija / Pcs.ctn.
1



šifra / art. no.

broj šuko utičnica /
number of schuko sockets

boja / color

480-103
(EAN 3856024406369)

1

●

Značajke

Omogućuje priključivanje utikača različitih standarda u šuko utičnicu
Putni adapter ne pretvara napone
Zaštita od direktnog kontakta

Features

Allows connection of different plug standards to a Schuko socket
Travel adapter does not convert voltages
Direct contact protection

ZAŠTITA OD DIREKTOG KONTAKTA / DIRECT CONTACT PROTECTION

Jednostavno postavljanje u bilo koju šuko utičnicu
Easy installation in any Schuko socket

šifra / art. no.
48109-1
(EAN 3858883838619)

boja / color
●

kom./kutija / pcs/ctn
10



Max. opterećenje / Max. load
16 A / 3680 W

Nazivni napon / Voltage
250 V~

Kom.kutija / Pcs.ctn.
10

Boja / Color
○

šifra / art. no.

broj utičnica /
number of sockets

stupanj zaštite /
IP grade

240-311
(EAN 3856024405935)

1

IP44

Max. opterećenje / Max. load
16 A

Nazivni napon / Voltage
250 V~

Kom.kutija / Pcs.ctn.
10

Boja / Color
○

šifra / art. no.

broj utičnica /
number of sockets

stupanj zaštite /
IP grade

240-501
(EAN 3858890443073)

3

IP44





KUĆNA AUTOMATIZACIJA HOME AUTOMATION

WIFI UTIČNICA / WIFI SOCKET

Max. opterećenje / Max. load
16 A / 3500 W

Nazivni napon / Voltage
230 V~

WIFI
2,4 GHz, 802.11b/g/n; +16dBm

Kom.kutija / Pcs.ctn.
60



Commel IoT
App
download

GET IT ON
Google Play



Download on the
App Store



šifra / art. no. broj šuko utičnica /
number of schuko sockets boja / color

265-307 **1** ●

(EAN 3856024405980)

Značajke

Upravlajte električnim uređajima na daljinu putem pametnog telefona ili tableta bez obzira gdje se nalazite
Funkcija programatora – za jednostavno podešavanje automatskog uključivanja i isključivanja
+ funkcija mjerača potrošnje električne energije

Features

Use smartphone or tablet to control your electrical appliances remotely from anywhere
Timer function – for easy setting of auto power on and off
+ power meter function



WIFI SMART MINI PREKIDAČ / WIFI SMART MINI SWITCH

Nazivni napon / Voltage
100-240 V~

WIFI
2,4 GHz, 802.11b/g/n; +16dBm

Dimenzije / Dimensions
46 x 44 x 16 mm

Stupanj zaštite / IP grade
IP20

Kom.kutija / Pcs.ctn.
100

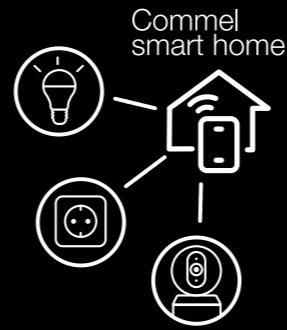
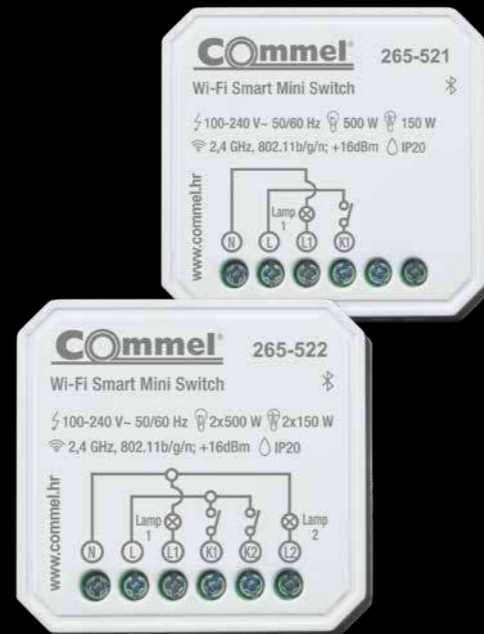

Commel IoT
App
download



Commel IoT
App
download



max. 800 W

max. 100 W

WIFI PREKIDAČ / WIFI SWITCH

Nazivni napon / Voltage
220-240 V~

WIFI
2,4 GHz, 802.11b/g/n; +16dBm

Ugadnja u instalacijsku kutiju /
Fits into an installation box
Ø 60

Stupanj zaštite / IP grade
IP20

Kom.kutija / Pcs.ctn.
60

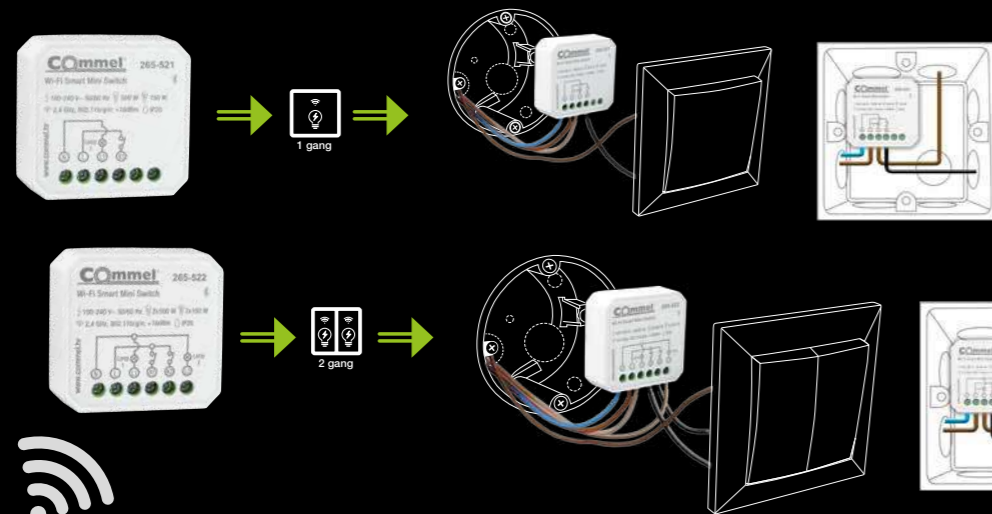

šifra / art. no. broj rasvjetnih tijela /
number of lighting fixtures

max. opterećenje /
max. load

265-521
(EAN 3856024404549)

1

150 W / 500 W

265-522
(EAN 3856024404556)

2

2 x 150 W / 2 x 500 W

Značajke

Features

Upravljanje pametnim mini prekidačima na daljinu putem pametnog telefona ili tableta bez obzira gdje se nalazite
Funkcija programatora - za jednostavno podešavanje automatskog uključivanja i isključivanja

Use smartphone or tablet to control your smart mini switch remotely from anywhere
Timer function - for easy setting of auto power on and off

šifra / art. no. broj rasvjetnih tijela /
number of lighting fixtures

max. opterećenje /
max. load

265-501
(EAN 3856024400053)

1

100 W / 800 W

265-502
(EAN 3856024400060)

2

100 W / 800 W

Značajke

Features

Upravljanje pametnim mini prekidačima na daljinu putem pametnog telefona ili tableta bez obzira gdje se nalazite
Funkcija programatora - za jednostavno podešavanje automatskog uključivanja i isključivanja

Use smartphone or tablet to control your smart mini switch remotely from anywhere
Timer function - for easy setting of auto power on and off

WIFI ŽARULJE / WIFI LIGHT BULBS

Nazivni napon / Voltage
220-240 V~

WIFI
2,4 GHz, 802.11b/g/n; +16dBm

Životni vijek / Lifespan
15.000 h

Stupanj zaštite / IP grade
IP20

Kom.kutija / Pcs.ctn.
5

WARM WHITE - COOL WHITE
3000K 6500 K

COLOR CHANGE

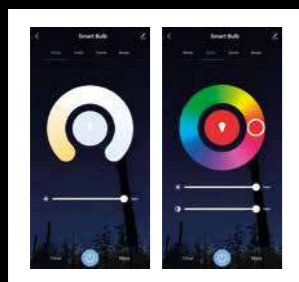

Commel IoT
App
download



Commel IoT
App
download

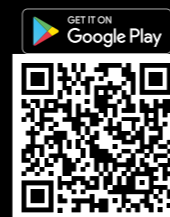

WIFI SMART PLAFONJERA / WIFI SMART CEILING LIGHT

Nazivni napon / Voltage
220-240 V~

WIFI
2,4 GHz, 802.11b/g/n; +16dBm

Životni vijek / Lifespan
25.000 h

Stupanj zaštite / IP grade
IP20

Kom.kutija / Pcs.ctn.
60

WARM WHITE - COOL WHITE
3000K 6500 K

COLOR CHANGE

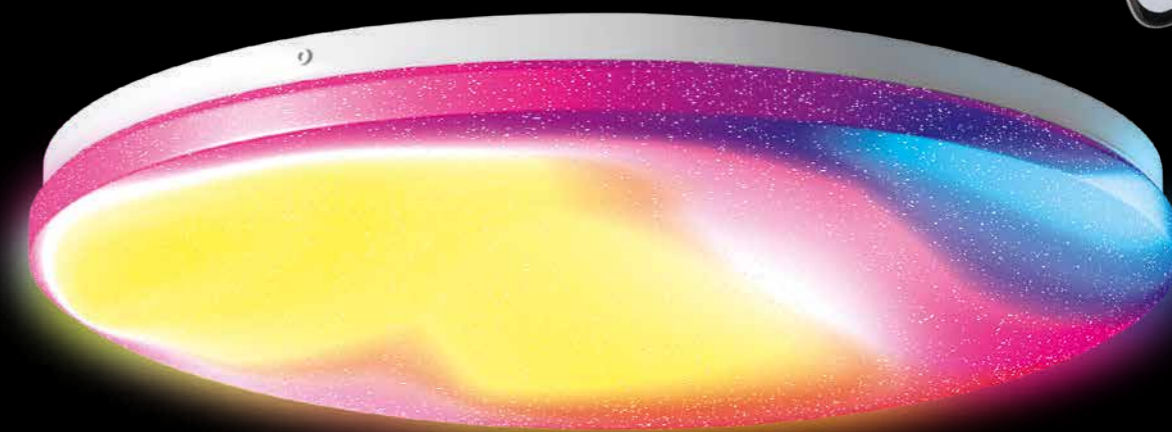

šifra / art. no.	baza / base	snaga / power	svjetlosni tok / luminous flux	temperatura svjetla / color temperature
305-701 (EAN 3856024402644)	E27	9 W	820 lm	3000-6500 K
305-702 (EAN 3856024407601)	C37	5,5 W	400 lm	3000-6500 K
305-703 (EAN 3856024407618)	GU10	5,5 W	400 lm	3000-6500 K

Značajke

Upravljaite pametnim žaruljama na daljinu putem pametnog telefona ili tableta bez obzira gdje se nalazite

Funkcija programatora - za jednostavno podešavanje automatskog uključivanja i isključivanja

Features

Use smartphone or tablet to control your smart bulbs remotely from anywhere

Timer function - for easy setting of auto power on and off

šifra / art. no.	snaga / power	svjetlosni tok / luminous flux	temperatura svjetla / color temperature	promjer svjetiljke / lamp diameter	kom./kutija / pcs/ctn
407-801 (EAN 3856024403603)	1 x 12 W	1 x 1200 lm	3000-6000 K	260 mm	20
407-802 (EAN 3856024403610)	1 x 24 W	1 x 2500 lm	3000-6000 K	380 mm	10
407-803 (EAN 3856024403627)	1 x 36 W	1 x 3800 lm	3000-6000 K	490 mm	10

Značajke

Upravljaite pametnim plafonjerama na daljinu putem pametnog telefona ili tableta bez obzira gdje se nalazite
Funkcija programatora - za jednostavno podešavanje automatskog uključivanja i isključivanja

Features

Use smartphone or tablet to control your smart ceiling lights remotely from anywhere
Timer function - for easy setting of auto power on and off

WIFI SMART KUTNA SVJETILJKA / WIFI SMART CORNER LAMP

Nazivni napon / Voltage
110-240 V DC 12 V

WIFI
2,4 GHz, 802.11b/g/n; +16dBm

Stupanj zaštite / IP grade
IP20

Kom.kutija / Pcs.ctn.
8

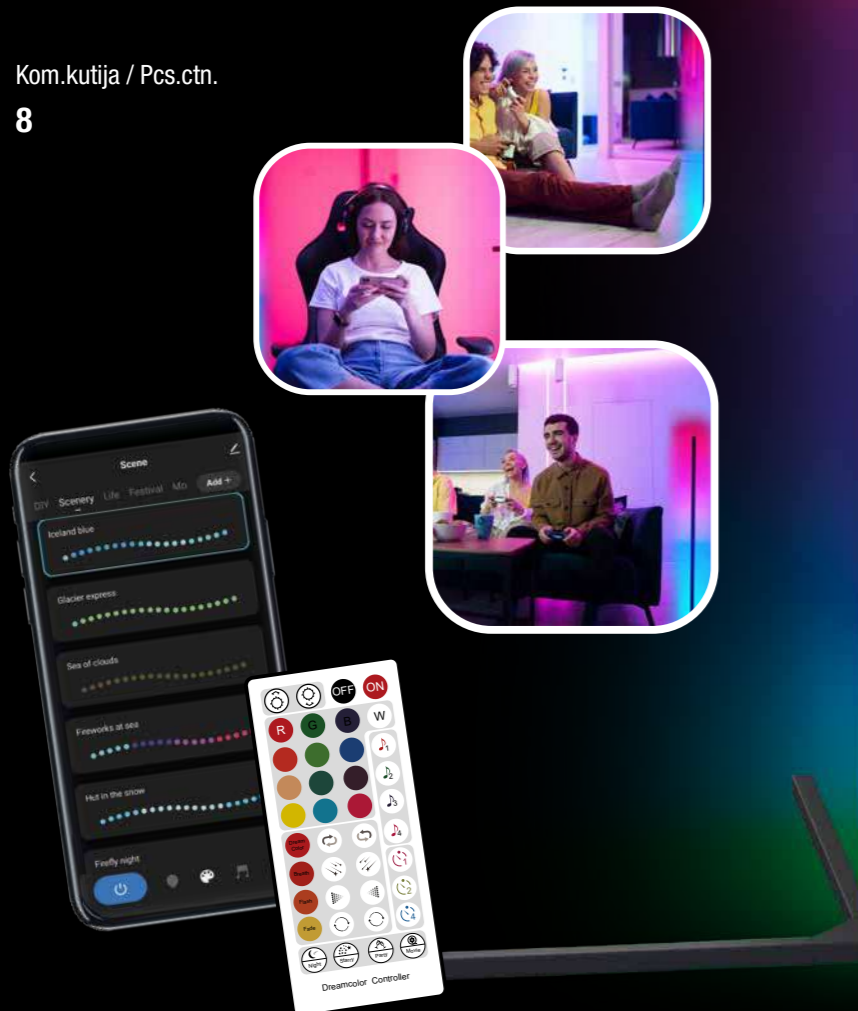

šifra / art. no. snaga / power visina svjetiljke / lamp height
405-502 **12 W** **1,4 m**
(EAN 3856024408097)

Značajke Features
Upravljanje pametnom kutnom svjetiljkom na daljinu putem pametnog telefona ili tableta bez obzira gdje se nalazite Use smartphone or tablet to control your smart corner lamp remotely from anywhere
Funkcija programatora - za jednostavno podešavanje automatskog uključivanja i isključivanja Timer function - for easy setting of auto power on and off



Commel IoT App download

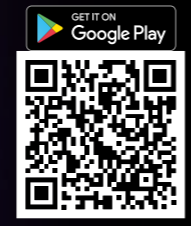

Commel IoT App download



Utor za Micro SD karticu
Micro SD slot



WIFI SMART KAMERA / WIFI SMART CAMERA

Nazivni napon ulazno-izlazni / Input voltage Input-output
AC 100-240 V, 50/60 Hz, 0,3 A
DC 5 V 1,5 A

WIFI
2.412 GHz~2.472 GHz, 802.11 b/g/n
5.150 GHz~5.850 GHz, 802.11a

Dimenzije / Dimensions
82 x 82 x 115 mm

Stupanj zaštite / IP grade
IP20

Kom.kutija / Pcs.ctn.
50



V. Rotacija / rotation 90°
H. Rotacija / rotation 355°

Podržava / Support
Micro SD
Max. 128 GB

Podržava / Support
WiFi 2.4 GHz / 5 GHz

Upravljanje putem aplikacije
App Remote Control

Detektor Pokreta
Motion Detection

Noćno snimanje
do 5 m / Night Vision
up to 5 m

Dvosmjerni Audio
Two-Way Audio

"Share" funkcija
Share Control

šifra / art. no. rezolucija kamere / camera resolution video kompresija / video compression dužina kabela / cable length
270-101 **Full HD** **H.264** **1 m, USB-C**
(EAN 3856024405997)

Značajke Features
Upravljanje pametnom kamerom na daljinu putem pametnog telefona ili tableta bez obzira gdje se nalazite Use smartphone or tablet to control your smart camera remotely from anywhere

**WIFI SMART VANJSKA KAMERA 2K/4MP IP65 /
WIFI SMART OUTDOOR CAMERA 2K/4MP**



Utor za Micro SD karticu
Micro SD slot



Commel IoT
App
download



Nazivni napon ulazno-izlazni / Input voltage Input-output

**AC 100-240 V, 50/60 Hz, 0,8 A
DC 12 V 2 A**

WIFI / ethernet

2.412 GHz~2.472 GHz, 802.11 b/g/n

Ethernet port

Dimenzije / Dimensions

95 x 160 x 135 mm

Stupanj zaštite / IP grade

IP65

Kom.kutija / Pcs.ctn.

30



V. Rotacija / rotation 90°
H. Rotacija / rotation 355°



Podržava / Support
Micro SD
Max. 128 GB



Podržava / Support
WiFi 2.4 GHz



Upravljanje putem
aplikacije
App Remote Control



Detektor Pokreta
Motion Detection



Noćno snimanje
do 5 m / Night Vision
up to 5 m



Dvosmjerni Audio
Two-Way Audio



"Share" funkcija
Share Control



Detekcija pomoću
umjetne inteligencije
AI Detection



Ugrađeno LED svjetlo
Built-in LED light



Podrška
Support

video kompresija /
video compression

H.264 +

dužina kabela /
cable length

60 cm

šifra / art. no. rezolucija kamere / camera resolution

**270-151
(EAN 3856024408127) Quad HD 2K, 4 MP**

Značajke
Upravljanje pametnom vanjskom kamerom na daljinu putem pametnog telefona ili tableta bez obzira gdje se nalazite

Features
Use smartphone or tablet to control your outdoor smart camera remotely from anywhere

DIGITALNI PROGRAMATOR, TJEDNI / DIGITAL TIMER, WEEKLY



Nazivni napon / Voltage Kom./kutija / Pcs/ctn

230 V~ 10

šifra / art. no. max. opterećenje / max. load

**261-103
(EAN 3858890448467) 16 A / 3500 W**

Značajke

**20 ON/OFF programa; Zaštita od direktnog kontakta
Minimalni vremenski interval: 1 minuta
Memorija postavki u slučaju nestanka struje
Odbrojavanje vremena; 12-satni ili 24-satni prikaz; LCD zaslon**

Features

**20 ON/OFF programs; Direct contact protection
Minimum time interval: 1 minute
Memory that saves the settings in case of power failure
Countdown timer; 12-hour or 24-hour display; LCD screen**

MEHANIČKI PROGRAMATOR, DNEVNI / MECHANICAL DAILY TIMER



Nazivni napon / Voltage Kom./kutija / Pcs/ctn

230 V~ 10

šifra / art. no. max. opterećenje / max. load

**90821
(EAN 3858883838480) 16 A / 3500 W**

**260-201
(EAN 3858890444612) 16 A / 3500 W**

stupanj zaštite /
IP grade

IP20

IP44

Značajke

**24-satno programiranje; Do 48 uključivanja/isključivanja dnevno
Minimalni vremenski interval: 30 minuta
Zaštita od direktnog kontakta**

Features

**24-hour programming; Up to 48 times on/off daily
Minimum time interval: 30 minutes
Direct contact protection**

PROGRAMATOR SA SENZOROM SVJETLA / TIMER WITH TWILIGHT SENSOR

Nazivni napon / Voltage
230 V~ 50 Hz

Kom./kutija / Pcs/ctn
48



šifra / art. no. max. opterećenje / max. load

261-180
(EAN 3856024406680) **16(2) A max. 3600 W**



Značajke

DUSK-DAWN - priključeni uređaj će se uključivati pri niskom ambijentalnom osvjetljenju a isključivati pri visokom ambijentalnom osvjetljenju.

7 načina rada; Zaštita od direktnog kontakta



Features

DUSK-DAWN – the connected device turns on in low ambient light and turns off in high ambient light.

7 working modes; Direct contact protection



MJERAČ POTROŠNJE ELEKTRIČNE ENERGIJE / POWER METER

Nazivni napon / Voltage
230 V~

Kom./kutija / Pcs/ctn
50

šifra / art. no. max. opterećenje / max. load

430-106
(EAN 3856024402576) **16 A / 3680 W**

Značajke

Veliki LCD zaslon; Dvotarifni; Zaštita od direktnog kontakta; Izračun cijene utrošene energije

Mogućnost mjerenja sljedećih parametara:

- snaga priključenog aparata (W)
- napon utičnice (V)
- frekvencija (Hz)
- struja (A)
- faktor snage (PF)

Features

Large LCD screen; Dual tariff; Direct contact protection

Calculation of energy consumption

Ability to measure the following parameters:

- power of connected appliance (W)
- socket voltage (V)
- frequency (Hz)
- electric current (A)
- power factor (PF)



UTIČNICE S DALJINSKIM UPRAVLJAČEM / REMOTE CONTROL SOCKETS

Max. opterećenje / Max. load
13 A / 3000 W

Baterija / Battery
1 x DC 3V CR2032

Nazivni napon / Voltage
230 V~

Kom./kutija / Pcs/ctn
10



šifra / art. no. broj šuko utičnica / number of schuko sockets domet / range

1	265-115 (EAN 3858890448474)	1	30 m
2	265-116 (EAN 3858890448481)	2	30 m

Značajke

Automatsko povezivanje
Zaštita od direktnog kontakta
Mogućnost uparivanja većeg broja utičnica na isti daljinski upravljač

Features

Automatic connection
Direct contact protection
The possibility of pairing a number of sockets to the same remote control

UTIČNICE S DALJINSKIM UPRAVLJAČEM / REMOTE CONTROL SOCKETS

Max. opterećenje / Max. load
16 A / 3680 W

Nazivni napon / Voltage
230 V~50 Hz

Baterija / Battery
1 x DC 3V CR2032

Kom./kutija / Pcs/ctn
5



šifra / art. no.	broj šuko utičnica / number of schuko sockets	IP zaštita / IP Grade	domet / range
265-117 (EAN 3856024405928)	1	IP44	40 m

Značajke	Features
Automatsko povezivanje	Automatic connection
Zaštita od direktnog kontakta	Direct contact protection
Mogućnost uparivanja većeg broja utičnica na isti daljinski upravljač	The possibility of pairing a number of sockets to the same remote control

Commel

BEŽIČNI PREKIDAČ / WIRELESS SWITCH

Nazivni napon / Voltage
230 V~50 Hz

Radna temperatura /
Working temperature
0-35°C

Kom./kutija / Pcs/ctn
5



Tipkalo
Transmitter



Prijemnik
Receiver

šifra / art. no.	max. opterećenje / max. load	domet / range
265-121 (EAN 3856024406000)	1000 W	30 m

Značajke	Features
Automatsko povezivanje	Automatic connection
Zaštita od direktnog kontakta	Direct contact protection
CR2032 - Baterija tipkala uključena u pakiranje	CR2032 - Transmitter battery included

Commel





MULTIMETRI I ISPITIVAČI NAPONA MULTIMETERS AND VOLTAGE TESTERS

DIGITALNI MULTIMETAR / DIGITAL MULTIMETER

šifra / art. no.
450-104
(EAN 3856024403641)



Funkcije / Functions
2 V - 300 V AC
200 mV - 300 V DC
200 μ A - 10 A DC
200 Ω - 20 M Ω
-20°C - 1000°C
0°F - 1800°F
20 nF - 1000 μ F

Tranzistor hFE test /
Transistor hFE test
PNP & NPN

Baterija u pakiranju /
Battery included
3 x 1,5 V AAA

Kom./kutija / Pcs/ctn
44

Značajke
CAT III; zaslon s 3 ½ znamenke (maks. prikaz: 1999);
mjerenje DC i AC napona, DC i AC struje, otpora, dioda, tranzistora hFE,
provodljivosti, temperature i kapaciteta
Indikacija prazne baterije; osvijetljeni zaslon; mjerni vodovi u pakiranju

Features
CAT III; 3 ½ digit display (max. reading: 1999); measuring DC and AC
voltage, direct current, resistance, capacity, temperature, test diodes
and perform audible tests of conductivity and circuits
Low battery indication; Illuminated screen; Test leads included

šifra / art. no.
450-102
(EAN 3858890443769)



Funkcije / Functions
200 V - 300 V AC
200 mV - 300 V DC
20 μ A - 10 A DC
200 Ω - 2 M Ω

Baterija u pakiranju /
Battery included
1 x 9 V DC

Kom./kutija / Pcs/ctn
60

Značajke
CAT III; zaslon s 3 ½ znamenke (maksimalni prikaz: 1999);
provjera dioda i provodljivosti
Indikacija prazne baterije; mjerni vodovi u pakiranju

Features
CAT III; 3 ½ digit display (max. reading: 1999);
Testing diode and continuity
Low battery indication; Test leads included

DIGITALNI MULTIMETAR / DIGITAL MULTIMETER



šifra / art. no.

450-103

(EAN 3858890443776)

Funkcije / Functions

200 V - 300 V AC

200 mV - 300 V DC

2000 μ A - 200 mA DC

200 Ω - 2000 k Ω

Baterija u pakiranju /
Battery included

1 x 12 V, 23 A

Kom./kutija / Pcs/ctn

42

Značajke

CAT III; zaslon s 3 1/2 znamenke (maksimalni prikaz: 1999); provjera dioda
Test baterija (1,5 V i 9 V); Indikacija prazne baterije

Features

CAT III; 3 1/2 digit display (max. reading: 1999); Testing diode
Battery test (1.5 V i 9 V); Low battery indication

DIGITALNA STRUJNA KLIJEŠTA / DIGITAL CLAMP METER



šifra / art. no.

450-201

(EAN 3856024403658)

Funkcije / Functions

300 V AC

300 V DC

20 A - 400 A AC

2000 Ω - 200 k Ω

Baterija u pakiranju /
Battery included

3 x 3V, CR2032

Kom./kutija / Pcs/ctn

60

Značajke

CAT III; zaslon s 3 1/2 znamenke (maksimalni prikaz: 1999)
Indikacija prazne baterije; mjerni vodovi u pakiranju
Funkcija zadržavanja podataka; Zaštita od preopterećenja

Features

CAT III; 3 1/2 digit display (max. reading: 1999)
Low battery indication; Test leads included
Data-hold function; Overload protection

DETEKTOR NAPONA - BEZKONTAKTNI / NON-CONTACT VOLTAGE DETECTOR

Baterija u pakiranju /
Battery included

2 x 1,5 V, AAA

Kom./kutija / Pcs/ctn

60

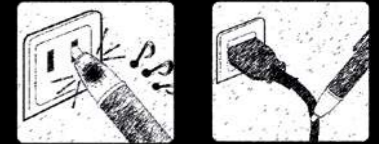

šifra / art. no. raspon napona / voltage range

445-201
(EAN 3858890443752)

70-1000 V ~ 50/60 Hz

Značajke

CAT III; sigurna detekcija napona - bez kontakta
Svjetlosna i zvučna signalizacija

Features

CAT III; Safe, non-contact voltage detection
LED and buzzer indication

ISPITIVAČ NAPONA / VOLTAGE TESTER

Baterija u pakiranju /
Battery included

2 x LR44 1.5 V

Kom./kutija / Pcs/ctn

48

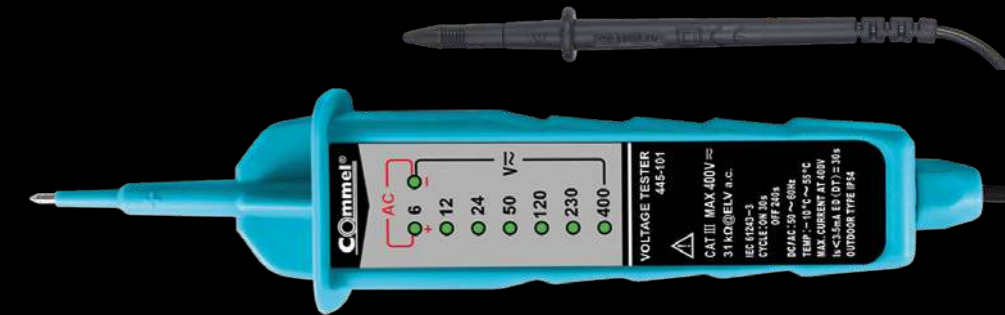

šifra / art. no. raspon napona / voltage range

445-101
(EAN 3858890443745)

6 V / 12 V / 24 V / 50 V / 120 V / 230 V / 400 V

frekvencija / frequency

50-60 Hz

Značajke

CAT III; LED indikacija u visini izmjerene napona
Indikacija polariteta DC napona

Features

CAT III; LED lights up to the voltage reading
DC voltage polarity indication

ISPITIVAČI NAPONA / VOLTAGE TESTERS

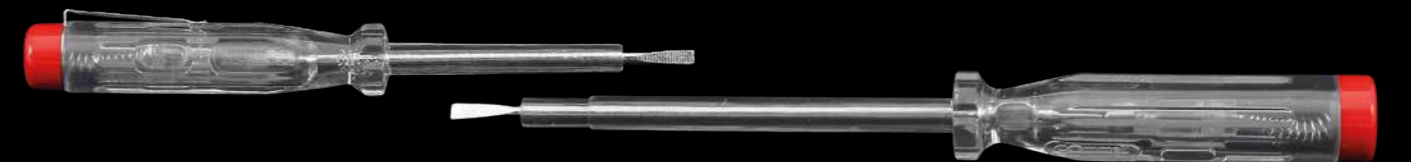

šifra / art. no.

445-301
(EAN 3856024401845)

dužina / length

140 mm

raspon napona / voltage range

200 - 250 V ~ 20

kom./kutija / pcs/ctn

20

445-302
(EAN 3856024401852)

190 mm

200 - 250 V ~ 20

20

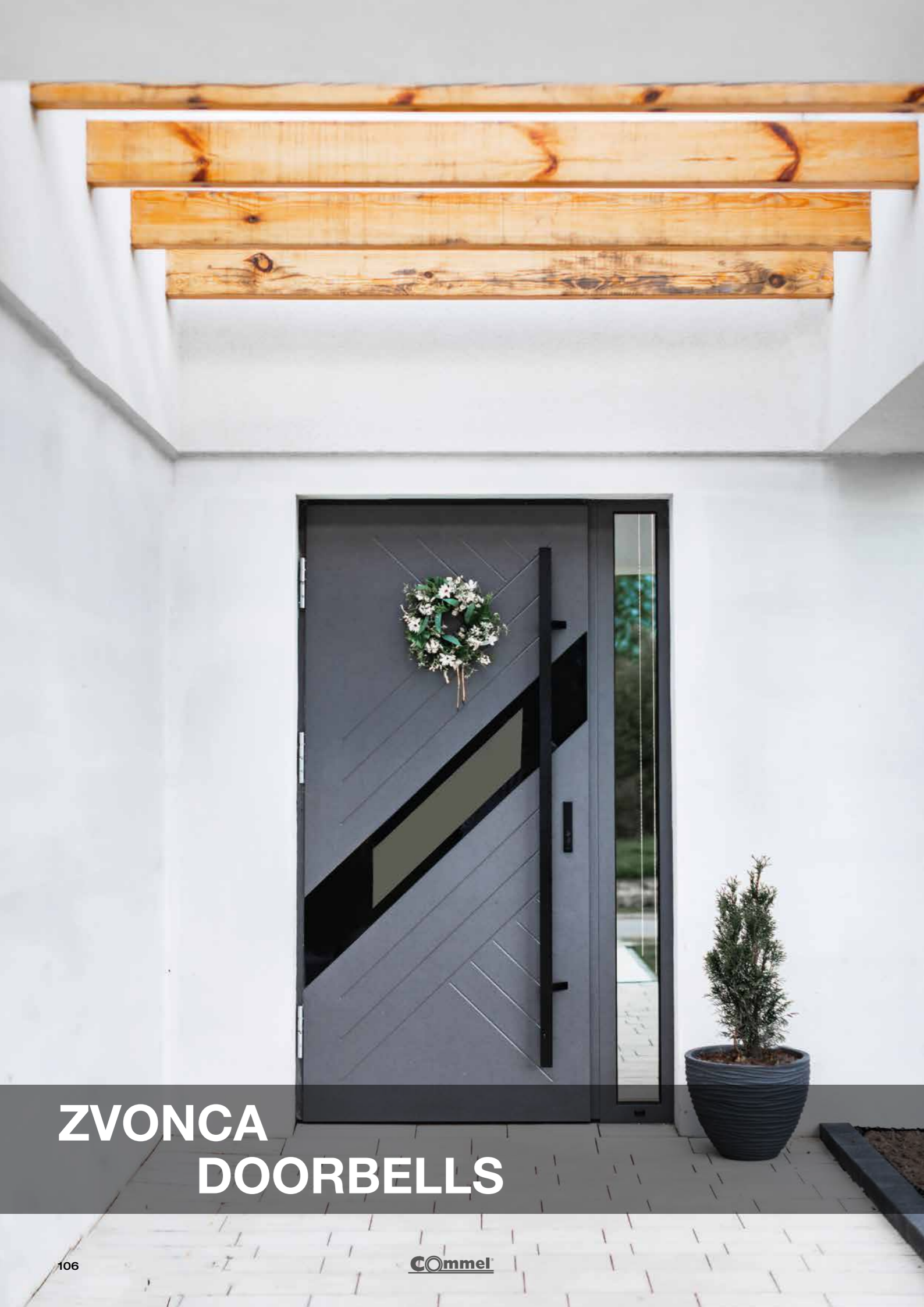

ZVONCA DOORBELLS

BEŽIČNA ZVONCA / WIRELESS DOORBELLS

Tipkalo / Transmitter

DC 3V CR2032
baterija u pakiranju /
battery included

Zvonce / Bell

2 x 1,5V DC AA
baterije nisu u pakiranju /
batteries not included

Kom./kutija / Pcs/ctn

10



	šifra / art. no.	broj melodija / number of melodies	jačina zvona / bell volume	domet / range
1	411-107 (EAN 3858883839135)	36	70 dB	300 m
2	411-108 (EAN 3858890443691)	36	70 dB	300 m

Značajke
Automatsko povezivanje; LED indikator; kućište od sjajne plastike
36 melodija; 3 načina rada: 1. zvono + svjetlosna indikacija;
2. samo zvono; 3. samo svjetlosna indikacija

Features
Auto-learning code; LED indicator; glossy plastic housing
36 melodies; 3 function options: 1. ring + LED flash;
2. ring only; 3. LED flash only

Tipkalo / Transmitter
DC 3V CR2032
 baterija u pakiranju /
 battery included

Zvonce / Bell
2 x 1,5V DC AA
 baterije nisu u pakiranju /
 batteries not included

Kom./kutija / Pcs/ctn
10



šifra / art. no.	broj melodija / number of melodies	jačina zvona / bell volume	domet / range
411-110 (EAN 3856024402682)	32	83 dB	100 m

Tipkalo / Transmitter
DC 3V CR2032
 baterija u pakiranju /
 battery included

Zvonce / Bell
3 x 1,5V DC AA
 baterije nisu u pakiranju /
 batteries not included

Frekvencija / frequency
433,92 MHz



Plavi LED indikator
 Blue LED indicator

šifra / art. no.	broj melodija / number of melodies	jačina zvona / bell volume	domet / range	kom./kutija / pcs/ctn
411-112 (EAN 3856024405669)	38	85 dB	200 m	10

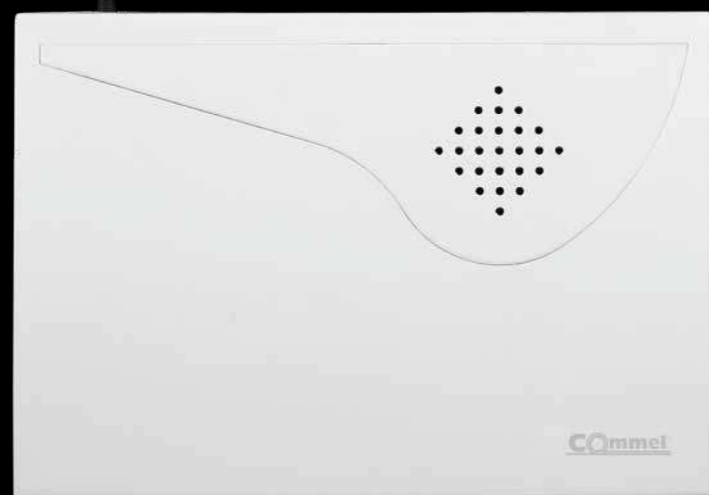

šifra / art. no.	broj melodija / number of melodies	jačina zvona / bell volume	domet / range
411-106 (EAN 3858883838473)	36	70 dB	300 m



Plavi LED indikator
 Blue LED indicator

Opcija stalka za stol
 Table stand option

šifra / art. no.	broj melodija / number of melodies	jačina zvona / bell volume	domet / range	kom./kutija / pcs/ctn
411-114 (EAN 3856024406635)	36	80 dB	200 m	5

Značajke	Features
Kućište obloženo tkaninom	Case covered with textile
Bez žica	No wires required

KINETIČKA ZVONCA / KINETIC DOORBELL



Zvonce / Bell
100-240 V~

Frekvencija /Frequency
433,92 MHz

šifra / art. no.	broj melodija / number of melodies	jačina zvona / bell volume	domet / range	kom./kutija / pcs/ctn
411-111 (EAN 3856024403399)	36	80 dB	100 m	10

Značajke Features
Bez žica i baterija No wires, no batteries required

ZVONCE ZA DIN ŠINU / DIN RAIL BELL

Nazivni napon / Voltage
220 - 240 V~ 50/60 Hz

šifra / art. no.	jačina zvona / bell volume	domet / range	kom./kutija / pcs/ctn
410-201 (EAN 3858890448603)	80 dB	100 m	12



ELEKTRIČNA ZVONCA / ELECTRIC DOORBELLS



Zvonce / Bell
220-240 V~ 50 Hz

Frekvencija /Frequency
433,92 MHz

	šifra / art. no.	broj melodija / number of melodies	jačina zvona / bell volume	nazivni napon / voltage	kom./kutija / pcs/ctn
1	410-104 (EAN 3856024402255)	1	80 dB	230 V~	10
2	410-105 (EAN 3856024402262)	1	80 dB	230 V~	10
3	410-106 (EAN 3856024402279)	1	80 dB	230 V~	10

KINETIČKO ZVONCE S NOĆNIM SVJETLOM / KINETIC DOORBELL WITH NIGHT LIGHT



Plavi LED indikator
Blue LED indicator

Noćno svjetlo
Night light

šifra / art. no.	broj melodija / number of melodies	jačina zvona / bell volume	domet / range	kom./kutija / pcs/ctn
411-113 (EAN 3856024406260)	36	80 dB	150 m	5

Značajke Features
Kućište obloženo tkaninom Case covered with textile
Bez žica i baterija No wires, no batteries required

PORTAFONI DOOR PHONES

Commel

Napajanje /
Power supply
DC 12 V 1100 mA

Noćno snimanje / Night recording
1 m

Dimenzije unutarnje jedinice /
Indoor unit dimensions
215 x 152 x 18 mm

Stupanj zaštite / IP grade
IP44

Dimenzije vanjske jedinice /
Outdoor unit dimensions
53 x 131 x 47 mm

Kom./kutija / Pcs/ctn
4



šifra / art. no.

501-104
(EAN 3858890447262)

veličina zaslona /
screen size

7"

broj melodija /
number of melodies

16

Zaslun u boji; handsfree komunikacija; mogućnost otključavanja 2 vrata
Značajke Features
Color screen; handsfree communication; unlocking two doors

Commel

Napajanje /
Power supply

DC 12 V 1100 mA

Noćno snimanje / Night recording

1 m

Dimenzije unutarnje jedinice /
Indoor unit dimensions

136 x 143 x 18,5 mm

Stupanj zaštite / IP grade

IP44

Dimenzije vanjske jedinice /
Outdoor unit dimensions

53 x 131 x 47 mm

Kom./kutija / Pcs/ctn

8

šifra / art. no. veličina zaslona /
screen size broj melodija /
number of melodies

501-105 **4,3"** **16**
(EAN 3858890447279)

Značajke
Zaslon u boji; handsfree komunikacija; mogućnost otključavanja 2 vrata

Features
Color screen; handsfree communication; unlocking two doors

Napajanje /
Power supply

DC 12 V 1100 mA

Noćno snimanje / Night recording

1 m

Dimenzije unutarnje jedinice /
Indoor unit dimensions

136 x 143 x 18,5 mm

Stupanj zaštite / IP grade

IP44

Dimenzije vanjske jedinice /
Outdoor unit dimensions

118 x 205 x 80 mm

Kom./kutija / Pcs/ctn

4

šifra / art. no. veličina zaslona /
screen size broj melodija /
number of melodies

501-205 **4,3"** **16**
(EAN 3858890449952)

Značajke
Zaslon u boji; handsfree komunikacija; mogućnost otključavanja 2 vrata

Features
Color screen; handsfree communication; unlocking two doors



šifra / art. no. broj melodija /
number of melodies kom./kutija /
pcs/ctn

502-103 **1** **20**
(EAN 3858890449938)



šifra / art. no. broj melodija /
number of melodies kom./kutija /
pcs/ctn

502-203 **1** **10**
(EAN 3858890449945)



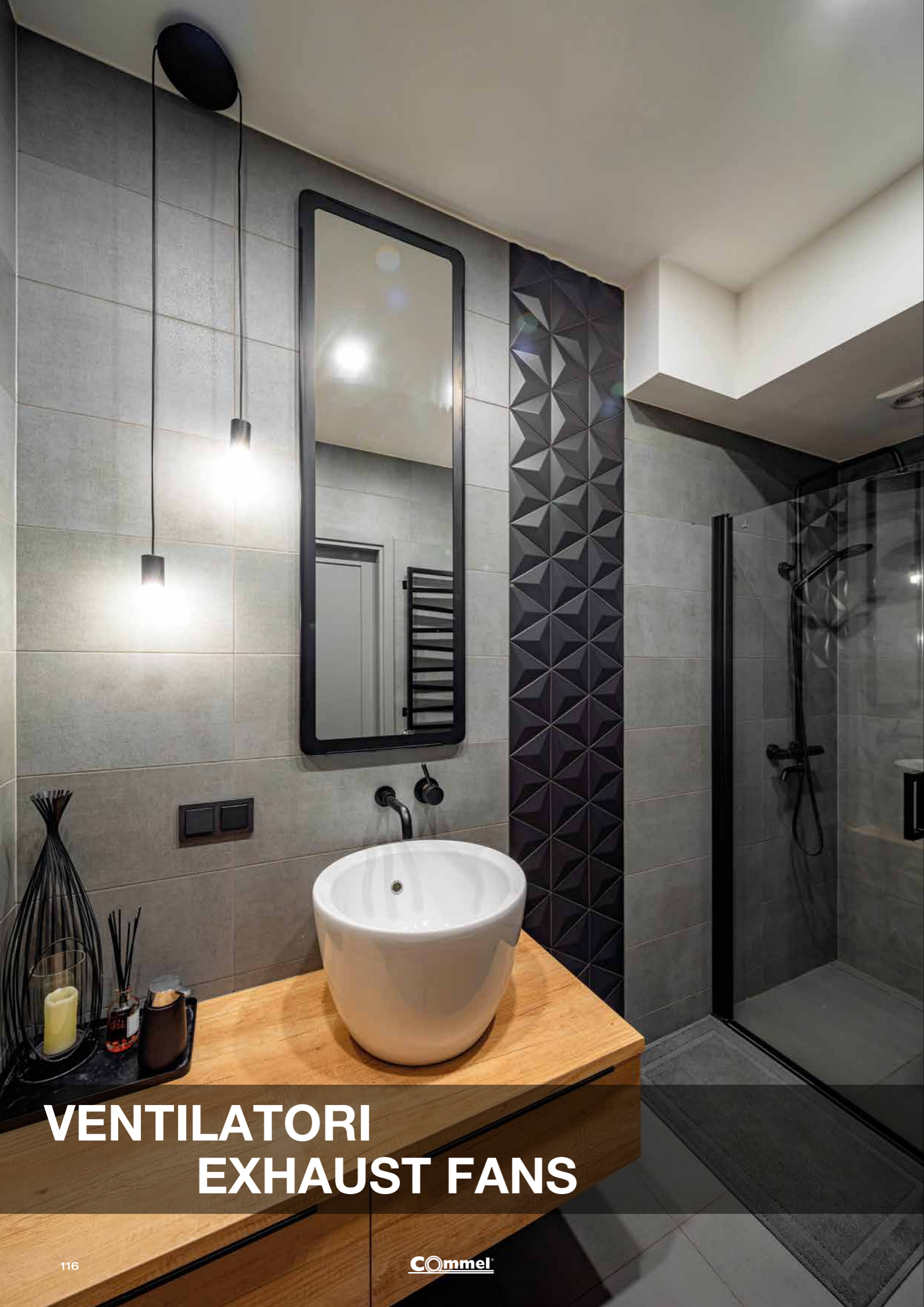

VENTILATORI EXHAUST FANS

Nazivni napon / Voltage
220-240 V~ 50 Hz

Razina buke / Noise level
34-35 dB



Stupanj zaštite / IP grade
IPX2

Kom./kutija / Pcs/ctn
20

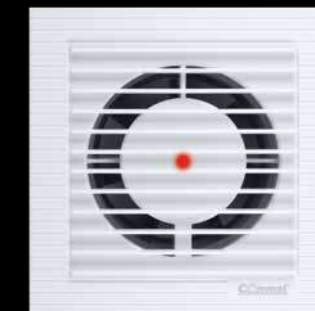

100 mm

šifra / art. no.	snaga / power	max. protok zraka / max air flow	brzina rotacije / motor rotation	odgoda gašenja / timer shut off delay / timer
420-101 (EAN 3858883835601)	12 W	130 m³/h	2400 rpm	-
420-102 (EAN 3858883835618)	12 W	130 m³/h	2400 rpm	✓

120 mm

420-111 (EAN 3858890446074)	16 W	240 m³/h	2200 rpm	-
420-112 (EAN 3858890446067)	16 W	240 m³/h	2200 rpm	✓

150 mm

420-121 (EAN 3858890446050)	18 W	320 m³/h	2000 rpm	-
420-122 (EAN 3858890446043)	18 W	320 m³/h	2000 rpm	✓



Nazivni napon / Voltage
220-240 V~ 50 Hz

Stupanj zaštite / IP grade
IPX4

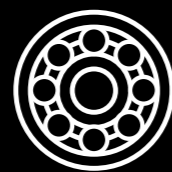

Motor s kugličnim ležajem
Ball bearing motor

Mogućnost stropne i zidne montaže
Possibility of ceiling and wall mounting

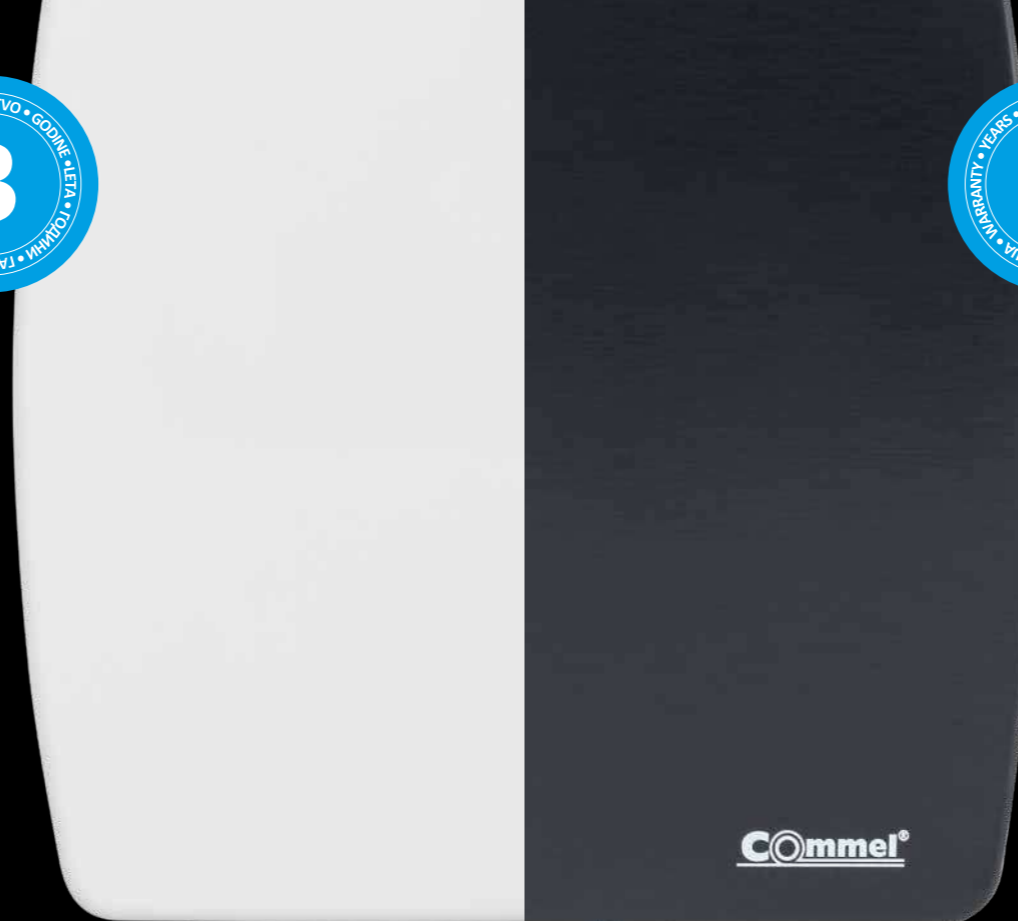

Nazivni napon / Voltage
220-240 V~ 50 Hz

Stupanj zaštite / IP grade
IPX4

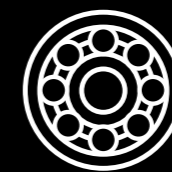

Motor s kugličnim ležajem
Ball bearing motor



Mogućnost stropne i zidne montaže
Possibility of ceiling and wall mounting

100 mm

šifra / art. no. (EAN)	snaga / power	max. protok zraka / max air flow	brzina rotacije / motor rotation	odgoda gašenja / timer shut off delay / timer	kom./kutija / pcs/ctn
420-201 (EAN 3856024406826)	12 W	95 m³/h	2200 rpm	-	20
420-202 (EAN 3856024406833)	12 W	95 m³/h	2200 rpm	✓	20

120 mm

420-211 (EAN 3856024406864)	16 W	160 m³/h	2000 rpm	-	24
420-212 (EAN 3856024406871)	16 W	160 m³/h	2000 rpm	✓	24

150 mm

420-221 (EAN 3856024406901)	18 W	240 m³/h	1850 rpm	-	16
420-222 (EAN 3856024406918)	18 W	240 m³/h	1850 rpm	✓	16

100 mm

šifra / art. no. (EAN)	snaga / power	max. protok zraka / max air flow	brzina rotacije / motor rotation	odgoda gašenja / timer shut off delay / timer	kom./kutija / pcs/ctn
420-203 (EAN 3856024406840)	12 W	95 m³/h	2200 rpm	-	20
420-204 (EAN 3856024406857)	12 W	95 m³/h	2200 rpm	✓	20

120 mm

420-213 (EAN 3856024406888)	16 W	160 m³/h	2000 rpm	-	24
420-214 (EAN 3856024406895)	16 W	160 m³/h	2000 rpm	✓	24

150 mm

420-223 (EAN 3856024406925)	18 W	240 m³/h	1850 rpm	-	16
420-224 (EAN 3856024406932)	18 W	240 m³/h	1850 rpm	✓	16

POKLOPCI VENTILACIJSKOG OTVORA / ROUND AIR VENT GRILLE

FLEKSIBILNE ALUMINIJSKE CIJEVI ZA VENTILACIJU / FLEXIBLE ALUMINUM DUCT



420-901



Mrežica sa stražnje strane / Mesh at the back



420-902



Rotirajuća rešetka za regulaciju protoka zraka / Rotating grille for air flow regulation



420-903



Rotirajući poklopac za regulaciju protoka zraka / Rotating cover for air flow regulation



Boja / Color
srebrna / silver

materijal / material
aluminij / aluminum

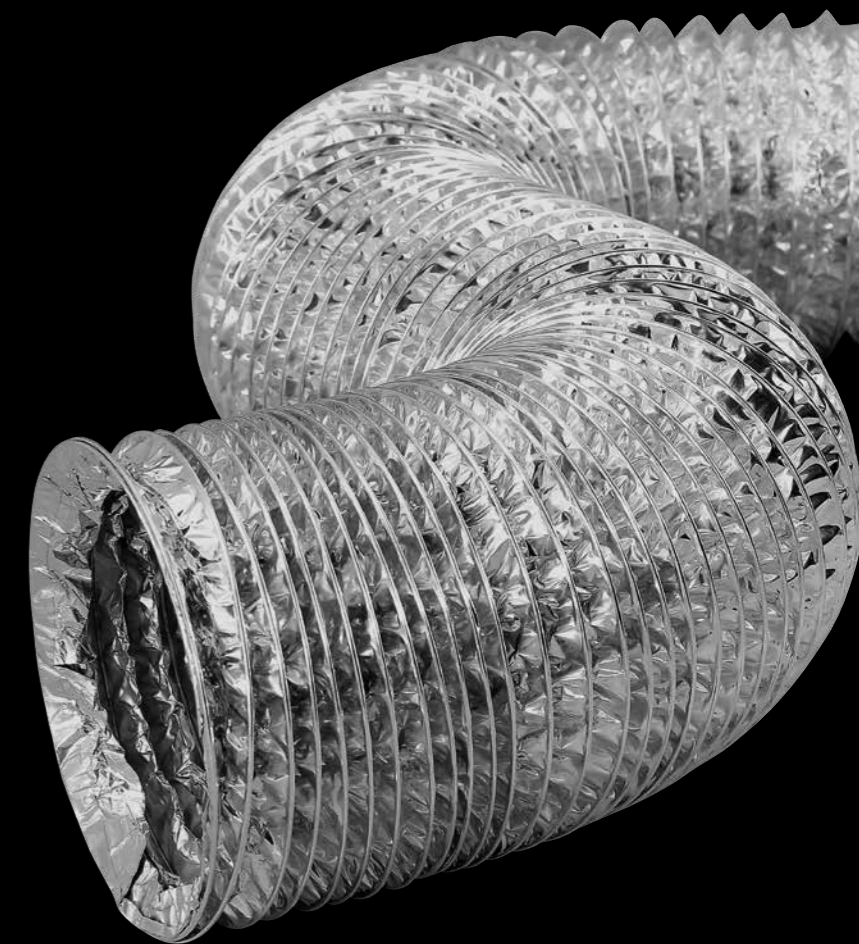
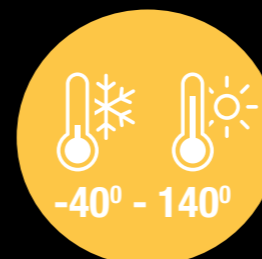

100 mm

šifra / art. no.	dužina / length	kom./kutija / pcs/ctn
420-951 (EAN 3856024407038)	1,5 m	40
420-952 (EAN 3856024407045)	3 m	50

120 mm

420-954 (EAN 3856024407052)	1,5 m	24
420-955 (EAN 3856024407069)	3 m	24

šifra / art. no.	boja / color	promjer / diameter	materijal / material	dimenzije / dimensions	kom./kutija / pcs/ctn
420-901 (EAN 3856024407007)	●	95 mm	ABS	148 x 70 x 95 mm	80
420-902 (EAN 3856024407014)	●	95 mm	ABS	148 x 70 x 95 mm	80
420-903 (EAN 3856024407021)	●	95 mm	ABS	148 x 70 x 95 mm	80



AUTOMATSKI OSIGURAČI I FID SKLOPKE RCCB & MINIATURE CIRCUIT BREAKER

AUTOMATSKI OSIGURAČI / MINIATURE CIRCUIT BREAKER

Nazivna prekidna moć / Breaking capacity Kom./kutija / Pcs/ctn
6000 A **12**

Polovi / Poles Karakteristika okidanja / Curve code

1	B	nazivna struja / rated current
šifra / art. no.		
465-132 (EAN 3856024401791)	32 A	
465-125 (EAN 3856024401784)	25 A	
465-120 (EAN 3856024401777)	20 A	
465-116 (EAN 3856024401760)	16 A	
465-113 (EAN 3856024406956)	13 A	
465-110 (EAN 3856024401753)	10 A	
465-106 (EAN 3856024401746)	6 A	

Polovi / Poles Karakteristika okidanja / Curve code

1	C	nazivna struja / rated current
šifra / art. no.		
465-240 (EAN 3856024404228)	40 A	
465-232 (EAN 3856024404211)	32 A	
465-225 (EAN 3856024404204)	25 A	
465-220 (EAN 3856024404198)	20 A	
465-216 (EAN 3856024404181)	16 A	
465-213 (EAN 3856024406963)	13 A	
465-210 (EAN 3856024404174)	10 A	



AUTOMATSKI OSIGURAČI / MINIATURE CIRCUIT BREAKER



Nazivna prekidna moć / Breaking capacity **6000 A** Kom./kutija / Pcs/ctn **4**

Polovi / Poles **3** Karakteristika okidanja / Curve code **C**

šifra / art. no.	nazivna struja / rated current
465-286 (EAN 3856024404266)	32 A
465-285 (EAN 3856024404259)	25 A
465-284 (EAN 3856024404242)	20 A
465-283 (EAN 3856024404235)	16 A

FID SKLOPKA / RCCB



Struja kratkog spoja / Rated short circuit current **6000 A**

Kom./kutija / Pcs/ctn **3**

FID SKLOPKA / RCCB

Struja kratkog spoja / Rated short circuit current **6000 A**

Kom./kutija / Pcs/ctn **6**

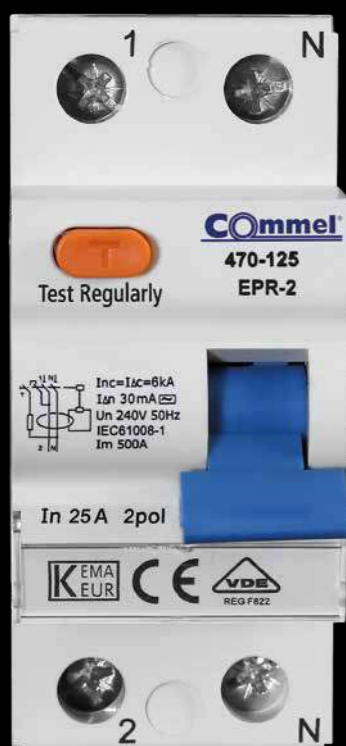

Tip / Type **AC** Polovi / Poles **2**

šifra / art. no.	nazivna struja / rated current	osjetljivost / rated sensitivity
470-140 (EAN 3856024401814)	40 A	0,3 A

Tip / Type **AC** Polovi / Poles **2**

470-141 (EAN 3856024404280)	40 A	0,03 A
470-125 (EAN 3856024401807)	25 A	0,03 A

Tip / Type **A** Polovi / Poles **2**

470-142 (EAN 3856024407632)	40 A	0,03 A
470-126 (EAN 3856024407625)	25 A	0,03 A

Tip / Type **AC** Polovi / Poles **4**

šifra / art. no.	nazivna struja / rated current	osjetljivost / rated sensitivity
470-263 (EAN 3856024404501)	63 A	0,03 A
470-241 (EAN 3856024404297)	40 A	0,03 A
470-225 (EAN 3856024404273)	25 A	0,03 A

Tip / Type **A** Polovi / Poles **4**

šifra / art. no.	nazivna struja / rated current	osjetljivost / rated sensitivity
470-264 (EAN 3856024407663)	63 A	0,03 A
470-242 (EAN 3856024407656)	40 A	0,03 A
470-226 (EAN 3856024407649)	25 A	0,03 A





KUĆNI PREKIDAČI I UTIČNICE HOME SWITCHES AND SOCKETS

PREKIDAČI I UTIČNICE - ADRIA / SWITCHES AND SOCKETS - ADRIA

Nazivni napon / Voltage
250 V~

Kom.kutija / Pcs.ctn.
8

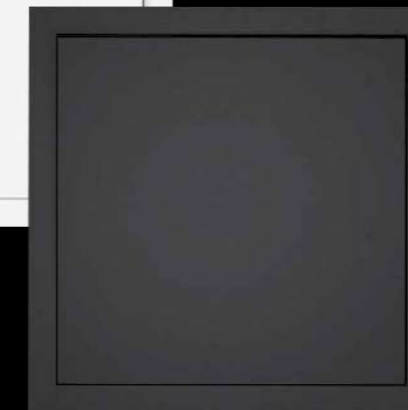
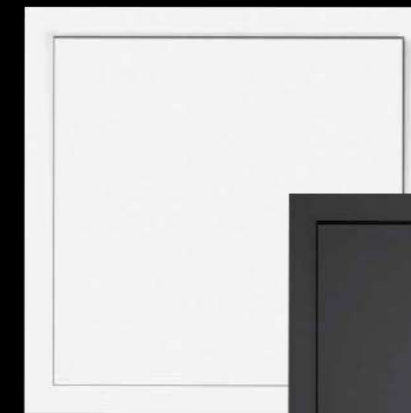

šifra / art. no.	naziv / type	max. opterećenje / max. load	boja / color
043-501 (EAN 3856024407670)	Jednopolna sklopka / 1 gang 1 way switch	10 A	●
043-601 (EAN 3856024407861)	Jednopolna sklopka / 1 gang 1 way switch	10 A	○
043-508 (EAN 3856024408288)	Jednopolna sklopka / 1 gang 1 way switch	16 A	●
043-608 (EAN 3856024408295)	Jednopolna sklopka / 1 gang 1 way switch	16 A	○
043-502 (EAN 3856024407687)	Izmjenična sklopka / 1 gang 2 way switch	10 A	●
043-602 (EAN 3856024407878)	Izmjenična sklopka / 1 gang 2 way switch	10 A	○
043-504 (EAN 3856024407700)	Križna sklopka / 1 key intermediate switch	10 A	●
043-604 (EAN 3856024407892)	Križna sklopka / 1 key intermediate switch	10 A	○

Značajke / Features
Stezaljka bez vijaka omogućava brzo ožičenje prekidača / Screwless wire terminal for quick connection



Max. opterećenje / Max. load
10 A

Nazivni napon / Voltage
250 V~

Kom.kutija / Pcs.ctn.
8

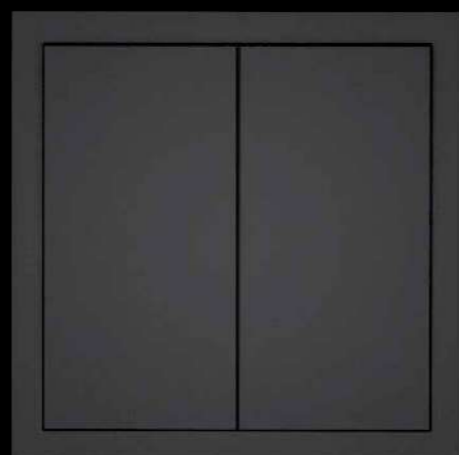
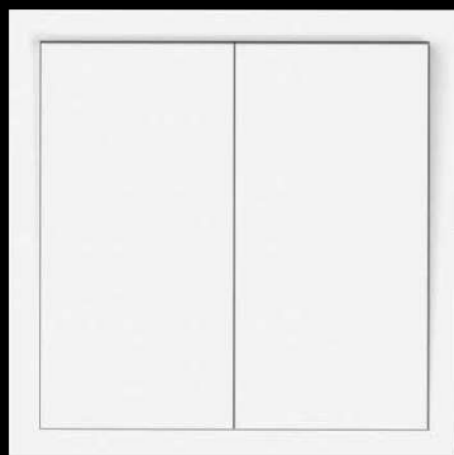

šifra / art. no.

naziv / type

boja / color

043-503
(EAN 3856024407694)

**Serijska jednopolna sklopka /
Surface 2 gang 1 way switch**



043-603
(EAN 3856024407885)

**Serijska jednopolna sklopka /
Surface 2 gang 1 way switch**



043-509
(EAN 3856024408325)

**Serijska izmjenična sklopka /
Surface 2 gang 2 way switch**



043-609
(EAN 3856024408332)

**Serijska izmjenična sklopka /
Surface 2 gang 2 way switch**



Značajke
**Stezaljka bez vijaka omogućava
brzo ožičenje prekidača**

Features
**Screwless wire terminal for
quick connection**

Max. opterećenje / Max. load
10 A

Nazivni napon / Voltage
250 V~

Kom.kutija / Pcs.ctn.
8

Značajke
**Stezaljka bez vijaka omogućava
brzo ožičenje prekidača**

Features
**Screwless wire terminal for
quick connection**

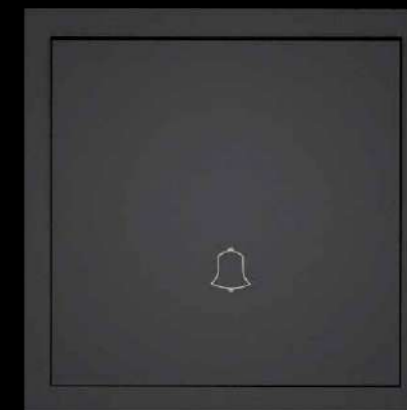

šifra / art. no.

naziv / type

boja / color

043-505
(EAN 3856024407717)

**Tipkalo za zvono /
Doorbell pushing switch**



043-605
(EAN 3856024407908)

**Tipkalo za zvono /
Doorbell pushing switch**



Max. opterećenje / Max. load
10 A

Nazivni napon / Voltage
250 V~

Kom.kutija / Pcs.ctn.
8

Značajke
**Stezaljka bez vijaka omogućava
brzo ožičenje prekidača**
Plavo LED svjetlo

Features
**Screwless wire terminal for
quick connection**
Blue LED light

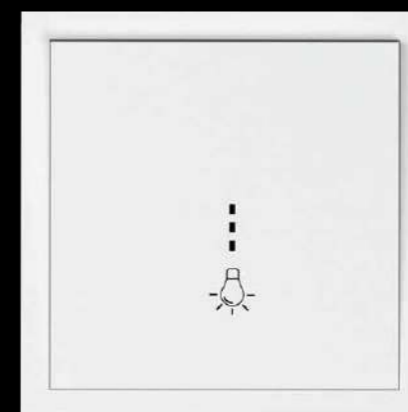

šifra / art. no.

naziv / type

boja / color

043-506
(EAN 3856024407724)

**Tipkalo s indikacijom /
Pushing switch with lamp**



043-606
(EAN 3856024407915)

**Tipkalo s indikacijom /
Pushing switch with lamp**



Max. opterećenje / Max. load

10 A

Nazivni napon / Voltage

250 V~

Kom.kutija / Pcs.ctn.

8

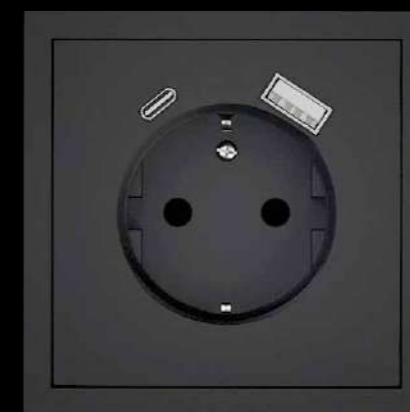
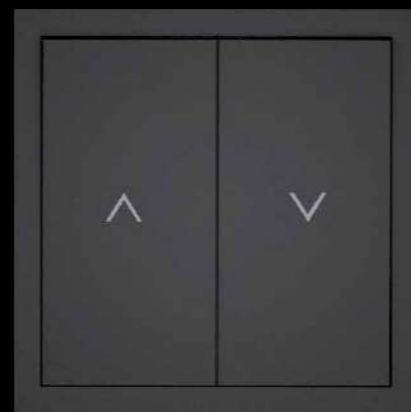

Max. opterećenje / Max. load

16 A

Nazivni napon / Voltage

250 V~

Kom.kutija / Pcs.ctn.

8

Značajke / Features

USB A+C (5 V=, 2,4 A)

Max 12.0 W

Značajke

Stezaljka bez vijaka omogućava brzo ožičenje prekidača

Features

Screwless wire terminal for quick connection

šifra / art. no.

043-507

(EAN 3856024407731)

naziv / type

Sklopka za rolete / Roller blind switch

boja / color



šifra / art. no.

043-519

(EAN 3856024407786)

naziv / type

Schuko utičnica s USB A+C - vijčani spoj / Schuko socket with USB A+C - screw wiring

boja / color



Značajke

Stezaljka bez vijaka omogućava brzo ožičenje prekidača

Features

Screwless wire terminal for quick connection

šifra / art. no.

043-607

(EAN 3856024407922)

naziv / type

Sklopka za rolete / Roller blind switch

boja / color



šifra / art. no.

043-619

(EAN 3856024407977)

naziv / type

Schuko utičnica s USB A+C - vijčani spoj / Schuko socket with USB A+C - screw wiring

boja / color



Max. opterećenje / Max. load

16 A

Nazivni napon / Voltage

250 V~

Kom.kutija / Pcs.ctn.

8

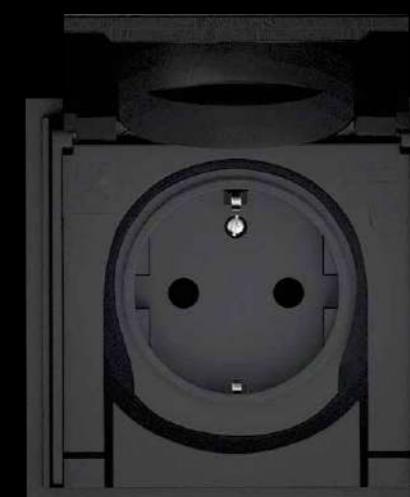
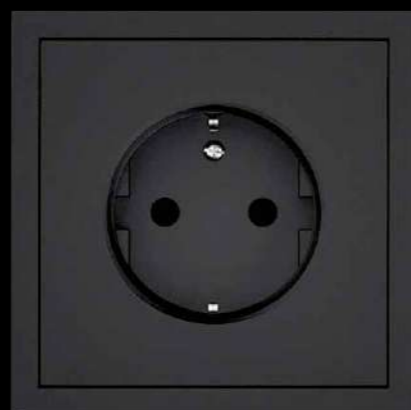

Stupanj zaštite / IP Grade

IP44

Max. opterećenje / Max. load

16 A

Nazivni napon / Voltage

250 V~

Kom.kutija / Pcs.ctn.

6

šifra / art. no.

043-515

(EAN 3856024407748)

naziv / type

Schuko utičnica - brzi spoj / Schuko socket - quick wiring

boja / color



šifra / art. no.

043-615

(EAN 3856024407939)

naziv / type

Schuko utičnica - brzi spoj / Schuko socket - quick wiring

boja / color



šifra / art. no.

043-516

(EAN 3856024407755)

naziv / type

Schuko utičnica - vijčani spoj / Schuko socket - screw wiring

boja / color



šifra / art. no.

043-616

(EAN 3856024407946)

naziv / type

Schuko utičnica - vijčani spoj / Schuko socket - screw wiring

boja / color



šifra / art. no.

043-517

(EAN 3856024407762)

naziv / type

Schuko utičnica s poklopcem / Schuko socket with lid

boja / color



šifra / art. no.

043-617

(EAN 3856024407953)

naziv / type

Schuko utičnica s poklopcem / Schuko socket with lid

boja / color



Značajke

Stezaljka bez vijaka omogućava brzo ožičenje prekidača

Features

Screwless wire terminal for quick connection

Max. opterećenje / Max. load
16 A

Nazivni napon / Voltage
250 V~

Kom.kutija / Pcs.ctn.
5



Značajke
Stezaljka bez vijaka omogućava
brzo ožičenje prekidača



Features
Screwless wire terminal for
quick connection

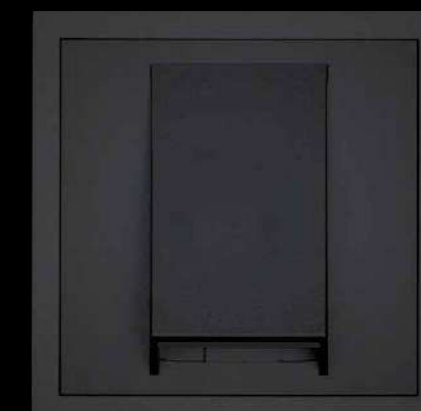

šifra / art. no.

naziv / type

boja / color

kom.kutija /
pcs.ctn.

043-520
(EAN 3856024407793)

**Maska za stalni priključak /
Cable outlet**



8

043-620
(EAN 3856024407984)

**Maska za stalni priključak /
Cable outlet**



8

šifra / art. no.

naziv / type

boja / color

043-518
(EAN 3856024407779)

**Dupla schuko utičnica /
Double schuko socket**



043-618
(EAN 3856024407960)

**Dupla schuko utičnica /
Double schuko socket**



Ugradnja u kutiju

Ø 60 mm

Fits into box



Commel

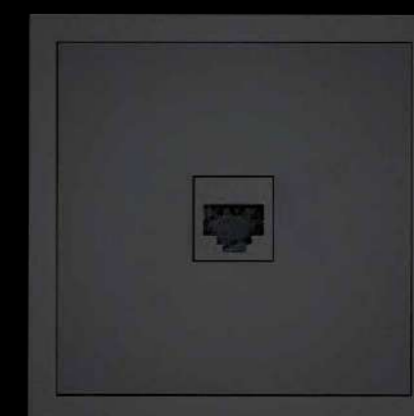

šifra / art. no.

naziv / type

boja / color

kom.kutija /
pcs.ctn.

043-523
(EAN 3856024408301)

**Utičnica RJ11 /
RJ11 socket**



8

043-623
(EAN 3856024408318)

**Utičnica RJ11 /
RJ11 socket**



8

Commel

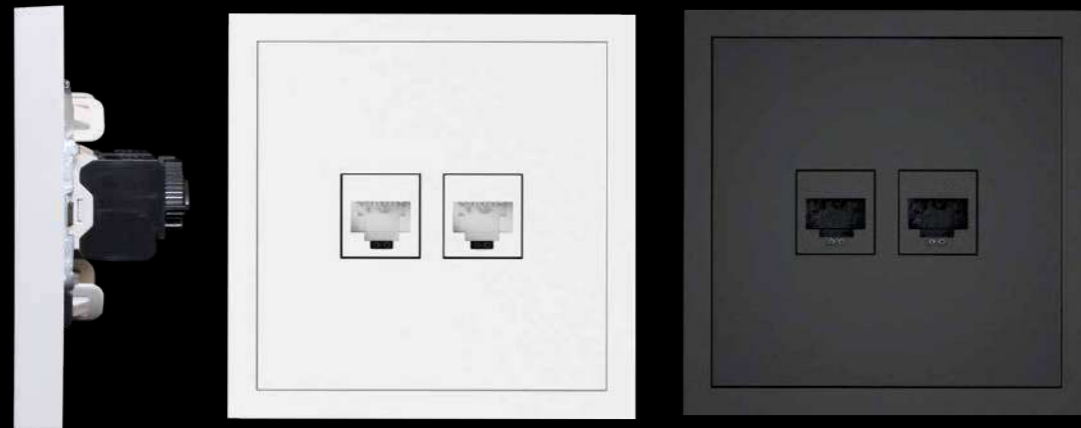

šifra / art. no.	naziv / type	boja / color	kom.kutija / pcs.ctn.
043-521 (EAN 3856024407809)	Utičnica RJ45 CAT6 dvostruka / Double RJ45 CAT6 socket	●	8
043-621 (EAN 3856024407991)	Utičnica RJ45 CAT6 dvostruka / Double RJ45 CAT6 socket	○	8

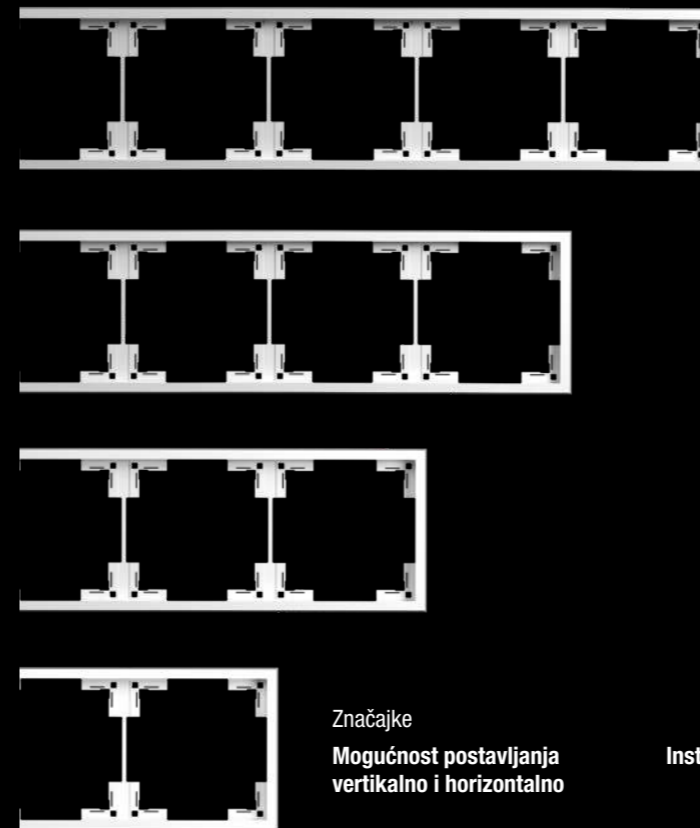

Značajke
Mogućnost postavljanja vertikalno i horizontalno

Features
Installation vertically and horizontally

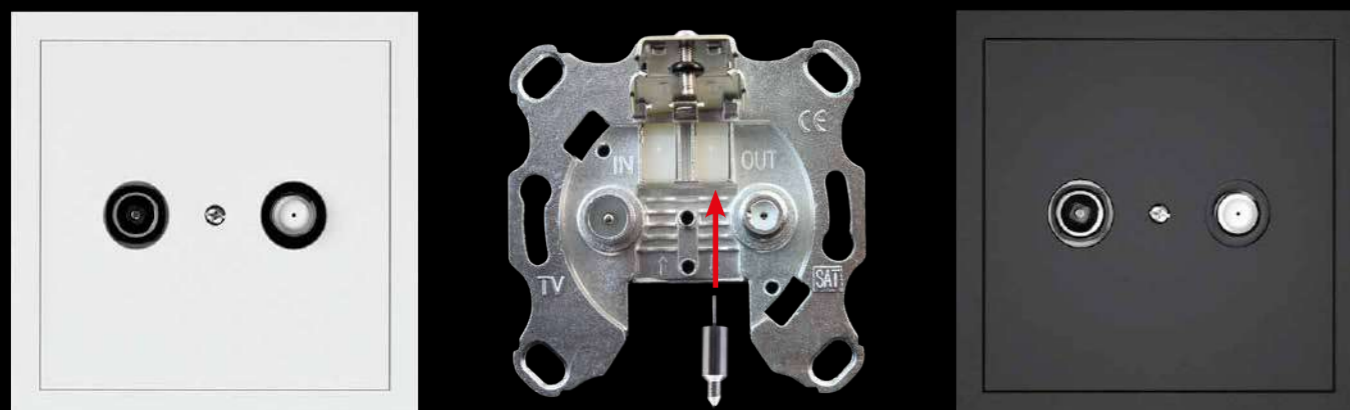
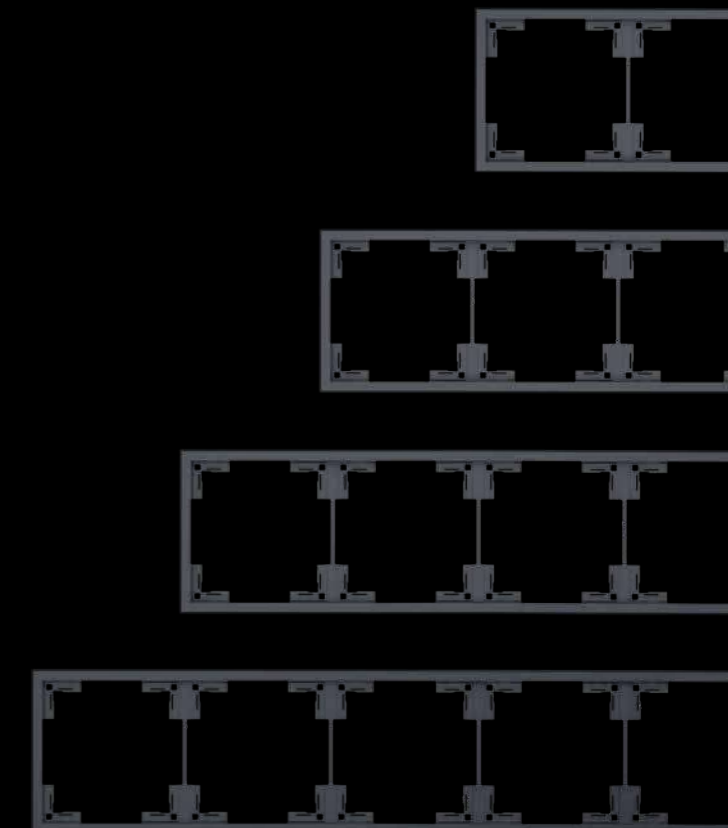

Značajke
Pakiranje sadrži prigušivač signala za pretvaranje iz prolazne 10 dB u završnu 2 dB utičnicu.

Features
The package contains an attenuator to convert from passthrough 10 dB into the end-line 2 dB socket.

šifra / art. no.	naziv / type	boja / color	kom.kutija / pcs.ctn.
043-522 (EAN 3856024407816)	Antenska TV+SAT utičnica / TV+SAT socket	●	8
043-622 (EAN 3856024408004)	Antenska TV+SAT utičnica / TV+SAT socket	○	8

šifra / art. no.	naziv / type	boja / color	kom.kutija / pcs.ctn.
043-532 (EAN 3856024407823)	Okvir 2X / Frame 2X	●	15
043-632 (EAN 3856024408011)	Okvir 2X / Frame 2X	○	15
043-533 (EAN 3856024407830)	Okvir 3X / Frame 3X	●	15
043-633 (EAN 3856024408028)	Okvir 3X / Frame 3X	○	15
043-534 (EAN 3856024407847)	Okvir 4X / Frame 4X	●	15
043-634 (EAN 3856024408035)	Okvir 4X / Frame 4X	○	15
043-535 (EAN 3856024407854)	Okvir 5X / Frame 5X	●	15
043-635 (EAN 3856024408042)	Okvir 5X / Frame 5X	○	15

PREKIDAČI I UTIČNICE - BURA / SWITCHES AND SOCKETS - BURA

Max. opterećenje / Max. load **10 A** Nazivni napon / Voltage **250 V~** Stupanj zaštite / IP Grade **IP55** Kom.kutija / Pcs.ctn. **10**

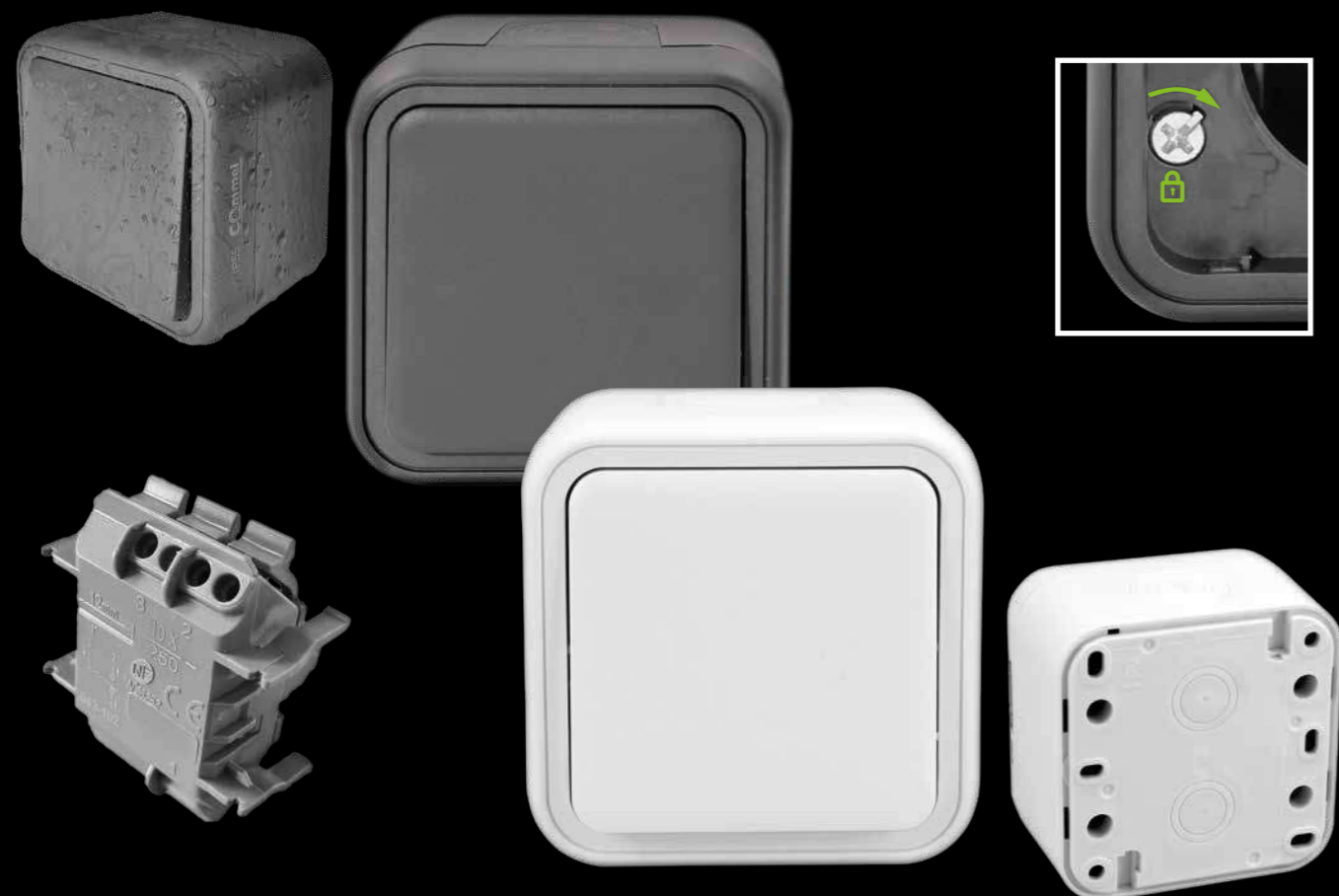

šifra / art. no.

naziv / type

boja / color

043-101
(EAN 3856024406277)

**Jednopolna instalacijska sklopka /
1 gang 1 way switch**



043-201
(EAN 3856024407090)

**Jednopolna instalacijska sklopka /
1 gang 1 way switch**



043-102
(EAN 3856024406284)

**Izmjenična instalacijska sklopka /
1 gang 2 way switch**



043-202
(EAN 3856024407106)

**Izmjenična instalacijska sklopka /
1 gang 2 way switch**



Značajke Features
 Rotirajuće bravice za brzo otvaranje bez vijaka Rotating locks for quick housing opening
 Gumene uvodnice na stražnjoj i bočnim stranama Rubber cable glands on the top, bottom and back of the housing
 Stezaljka bez vijaka omogućava brzo ožičenje prekidača Screwless wire terminal for quick connection

Max. opterećenje / Max. load **10 A** Nazivni napon / Voltage **250 V~** Stupanj zaštite / IP Grade **IP55** Kom.kutija / Pcs.ctn. **10**



šifra / art. no.

naziv / type

boja / color

043-105
(EAN 3856024406291)

**Serijska instalacijska sklopka /
2 gang 1 way switch**



043-205
(EAN 3856024407113)

**Jednopolna instalacijska sklopka /
1 gang 1 way switch**



šifra / art. no.

naziv / type

boja / color

043-106
(EAN 3856024406949)

**Tipkalo s indikacijom /
Push switch with light**



043-206
(EAN 3856024407120)

**Tipkalo s indikacijom /
Push switch with light**



Značajke Features
 Rotirajuće bravice za brzo otvaranje bez vijaka Rotating locks for quick housing opening
 Gumene uvodnice na stražnjoj i bočnim stranama Rubber cable glands on the top, bottom and back of the housing
 Stezaljka bez vijaka omogućava brzo ožičenje prekidača Screwless wire terminal for quick connection

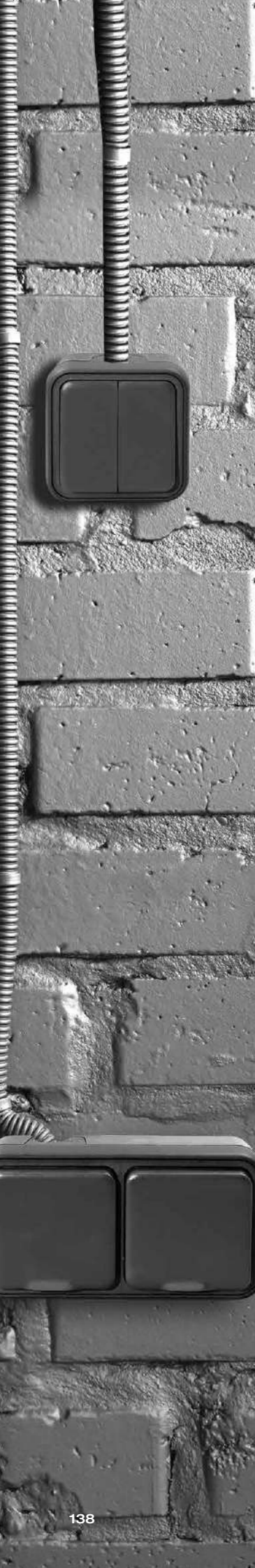

Max. opterećenje / Max. load
16 A

Stupanj zaštite / IP Grade
IP55

Nazivni napon / Voltage
250 V~

Kom.kutija / Pcs.ctn.
10

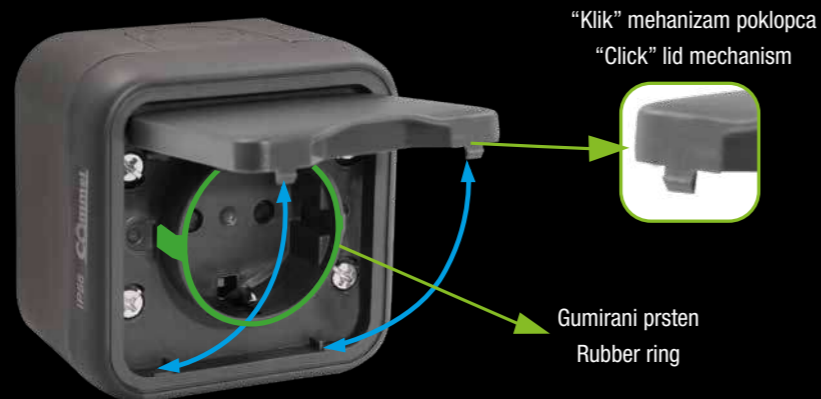

šifra / art. no.

naziv / type

boja / color

043-111
(EAN 3856024406307)

**Dvopolna utičnica /
Schuko socket**



043-211
(EAN 3856024407137)

**Dvopolna utičnica /
Schuko socket**



Značajke
Rotirajuće bravice za brzo otvaranje bez vijaka
Gumene uvodnice na stražnjoj i bočnim stranama

Features
Rotating locks for quick housing opening
Rubber cable glands on the top, bottom and back of the housing

Max. opterećenje / Max. load
16 A

Nazivni napon / Voltage
250 V~

Stupanj zaštite / IP Grade
IP55

Kom.kutija / Pcs.ctn.
5



šifra / art. no.

naziv / type

boja / color

043-112
(EAN 3856024406314)

**Dvopolna utičnica - dvostruka /
Schuko double socket**



043-212
(EAN 3856024407144)

**Dvopolna utičnica - dvostruka /
Schuko double socket**



Max. opterećenje / Max. load
16 A / 10 A

Nazivni napon / Voltage
250 V~

Stupanj zaštite / IP Grade
IP55

Kom.kutija / Pcs.ctn.
5



šifra / art. no.

naziv / type

boja / color

043-113
(EAN 3856024406321)

**Dvopolna utičnica
+ sklopka /
Schuko socket
+ switch**



043-213
(EAN 3856024407151)

**Dvopolna utičnica
+ sklopka /
Schuko socket
+ switch**



Značajke
Rotirajuće bravice za brzo otvaranje bez vijaka
"Klik" mehanizam poklopca

Features
Rotating locks for quick housing opening
"Click" lid mechanism



MONTAŽNI PRIBOR MOUNTING ACCESSORIES

Kom./kutija / Pcs/ctn

20

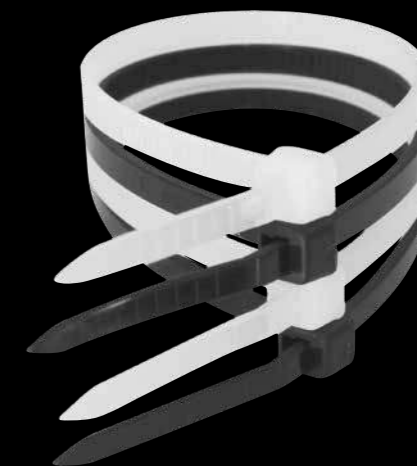

KABELSKE VEZICE / CABLE TIES

šifra / art. no. (EAN)	promjer / diameter	dužina / length	boja / color	kom./pak / pcs/pkg
365-101 (EAN 3858890440003)	2,5 mm	100 mm	●	100
365-102 (EAN 3858890440027)	2,5 mm	100 mm	○	100
365-103 (EAN 3858890440041)	2,5 mm	150 mm	●	100
365-104 (EAN 3858890440065)	2,5 mm	150 mm	○	100
365-111 (EAN 3858890440089)	3,5 mm	150 mm	●	100
365-112 (EAN 3858890440102)	3,5 mm	150 mm	○	100
365-113 (EAN 3858890440126)	3,5 mm	200 mm	●	100
365-114 (EAN 3858890440140)	3,5 mm	200 mm	○	100
365-121 (EAN 3858890440164)	4,7 mm	300 mm	●	100
365-122 (EAN 3858890440188)	4,7 mm	300 mm	○	100
365-123 (EAN 3858890441147)	4,7 mm	380 mm	●	50
365-124 (EAN 3858890441154)	4,7 mm	380 mm	○	50
365-131 (EAN 3858890441161)	7,5 mm	250 mm	●	25
365-132 (EAN 3858890441178)	7,5 mm	250 mm	○	25
365-133 (EAN 3858890441185)	7,5 mm	400 mm	●	25
365-134 (EAN 3858890441192)	7,5 mm	400 mm	○	25





Kom./kutija / Pcs/ctn
20

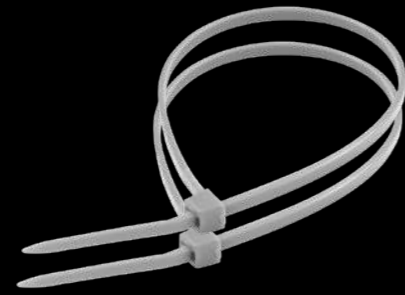

šifra / art. no.	promjer / diameter	dužina / length	boja / color	kom./pak / pcs/pkg
365-135 (EAN 3856024408103)	4,7 mm	300 mm		100
365-136 (EAN 3856024408110)	7,5 mm	400 mm		25

Kom./kutija / Pcs/ctn
20

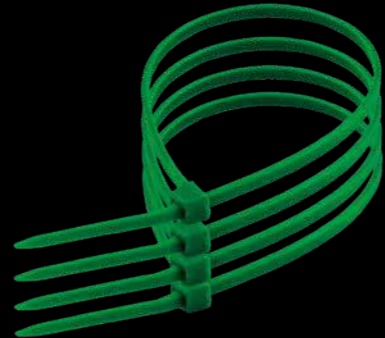

šifra / art. no.	promjer / diameter	dužina / length	boja / color	kom./pak / pcs/pkg
365-115 (EAN 3856024404754)	3,5 mm	200 mm		100

Kom./kutija / Pcs/ctn
20



šifra / art. no.	promjer / diameter	dužina / length	boja / color	kom./pak / pcs/pkg
365-175 (EAN 3856024403252)	2,5 mm	150 mm	5 boja / 5 colors	100
365-176 (EAN 3856024403269)	3,6 mm	200 mm	5 boja / 5 colors	100
365-177 (EAN 3856024403276)	4,8 mm	300 mm	5 boja / 5 colors	100



Kom./pak / Pcs/pkg
170

šifra / art. no.	specifikacija / specification
365-173 (EAN 3856024401739)	2,5 mm x 100 mm x 100 3,5 x 200 mm x 40 4,5 mm x 200 mm x 30

Kom./pak / Pcs/pkg
300

šifra / art. no.	specifikacija / specification
365-172 (EAN 3858890447392)	2,5 mm x 100 mm crvena / red x 25 2,5 mm x 100 mm žuta / yellow x 25 2,5 mm x 100 mm crna / black x 25 2,5 mm x 100 mm zelena / green x 25 2,5 mm x 100 mm bijela / white x 50 3,5 mm x 200 mm crvena / red x 50 3,5 mm x 200 mm plava / blue x 50 3,5 mm x 200 mm bijela / white x 50



Kom./pak / Pcs/pkg
400

šifra / art. no.	specifikacija / specification
365-171 (EAN 3858890440201)	2,5 mm x 100 mm bijela / white x 200 2,5 mm x 100 mm crna / black x 100 3,5 mm x 200 mm bijela / white x 50 3,5 mm x 200 mm crna / black x 50



KABELSKE VEZICE S RUPOM ZA PRIČVRŠĆIVANJE / MOUNTABLE HEAD CABLE TIES

Kom./kutija / Pcs/ctn

20

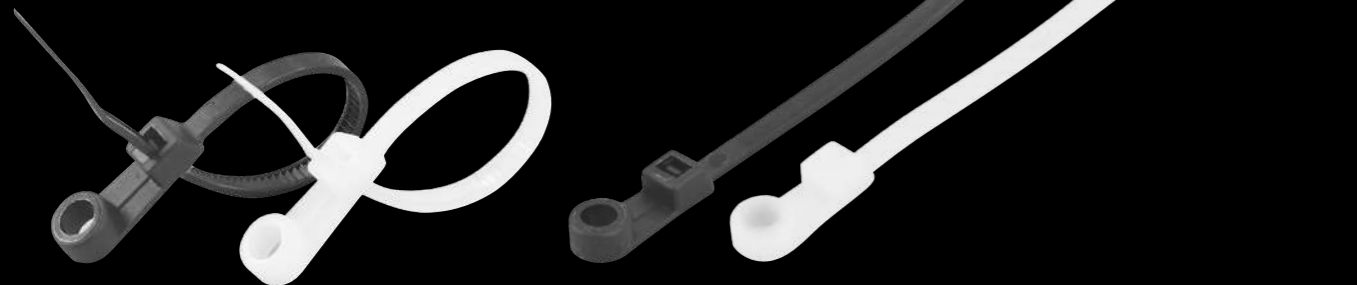

šifra / art. no.	promjer / diameter	dužina / length	boja / color	kom./pak / pcs/pkg
365-141 (EAN 3856024403009)	3,6 mm	100 mm	●	100
365-142 (EAN 3856024403016)	3,6 mm	100 mm	○	100
365-143 (EAN 3856024403023)	3,6 mm	145 mm	●	100
365-144 (EAN 3856024403030)	3,6 mm	145 mm	○	100
365-145 (EAN 3856024403047)	4,3 mm	220 mm	●	100
365-146 (EAN 3856024403054)	4,3 mm	220 mm	○	100
365-147 (EAN 3856024403061)	7,6 mm	381 mm	●	25
365-148 (EAN 3856024403078)	7,6 mm	381 mm	○	25

KABELSKE VEZICE ODVEZIVE / RELEASABLE CABLE TIES



šifra / art. no.	promjer / diameter	dužina / length	boja / color	kom./pak / pcs/pkg
365-001 (EAN 3856024403085)	7,5 mm	200 mm	●	25
365-002 (EAN 3856024403092)	7,5 mm	200 mm	○	25
365-003 (EAN 3856024403108)	7,5 mm	250 mm	●	25
365-004 (EAN 3856024403115)	7,5 mm	250 mm	○	25
365-005 (EAN 3856024403122)	7,5 mm	300 mm	●	25
365-006 (EAN 3856024403139)	7,5 mm	300 mm	○	25
365-007 (EAN 3856024403146)	7,5 mm	370 mm	●	25
365-008 (EAN 3856024403153)	7,5 mm	370 mm	○	25



KABELSKE VEZICE ZA VIŠEKRAATNU UPOTREBU / KNOT CABLE TIES

Kom./kutija / Pcs/ctn

20

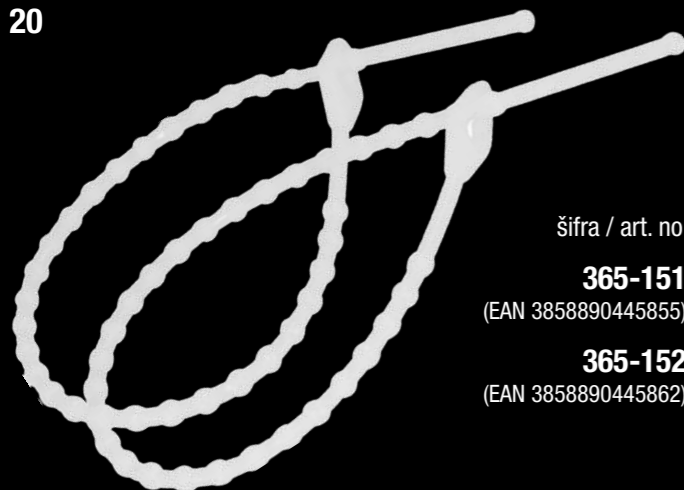

šifra / art. no.	dužina / length	boja / color	kom./pak / pcs/pkg
365-151 (EAN 3858890445855)	120 mm	●	100
365-152 (EAN 3858890445862)	180 mm	●	100

KABELSKE VEZICE S DVOSTRUKOM OMČOM / DOUBLE LOOP CABLE TIES

šifra / art. no.	promjer / diameter	dužina / length	boja / color	kom./pak / pcs/pkg
365-051 (EAN 3856024403191)	4,8 mm	200 mm	●	50
365-052 (EAN 3856024403207)	4,8 mm	200 mm	○	50



KABELSKE VEZICE, VATROOTPORNE / FLAME RETARDANT CABLE TIES

Kom./kutija / Pcs/ctn

20



šifra / art. no. (EAN)	promjer / diameter	dužina / length	boja / color	kom./pak / pcs/pkg
365-161 (EAN 3856024403160)	3,6 mm	150 mm	●	100
365-162 (EAN 3856024403177)	3,6 mm	200 mm	●	100
365-163 (EAN 3856024403184)	4,8 mm	300 mm	●	100

Samogasive, u skladu sa standardom UL94-V0
Fire-retardant, According to standard UL94-V0



METALNE KABELSKE VEZICE / STAINLESS STEEL CABLE TIES

Kom./kutija / Pcs/ctn

20



šifra / art. no. (EAN)	promjer / diameter	dužina / length	boja / color	kom./pak / pcs/pkg
365-181 (EAN 3856024403214)	4,6 mm	200 mm	●	25
365-182 (EAN 3856024403221)	4,6 mm	500 mm	●	25
365-183 (EAN 3856024403238)	7,9 mm	200 mm	●	25
365-184 (EAN 3856024403245)	7,9 mm	500 mm	●	25

KABELSKE VEZICE NA ČIČAK / VELCRO CABLE TIES

Kom./kutija / Pcs/ctn

20



šifra / art. no. (EAN)	promjer / diameter	dužina / length	boja / color	kom./pak / pcs/pkg
365-191 (EAN 3856024403283)	12 mm	135 mm	○	10
365-192 (EAN 3856024403290)	16 mm	210 mm	○	10



SAMOLJEPLJIVI DRŽAČI VEZICA / SELF ADHESIVE TIE MOUNTS

Kom./kutija / Pcs/ctn

20

šifra / art. no. (EAN)	dimenzije / dimensions	boja / color	kom./pak / pcs/pkg
365-331 (EAN 3858890447170)	20 x 20 mm	●	25
365-332 (EAN 3858890447187)	30 x 30 mm	●	25

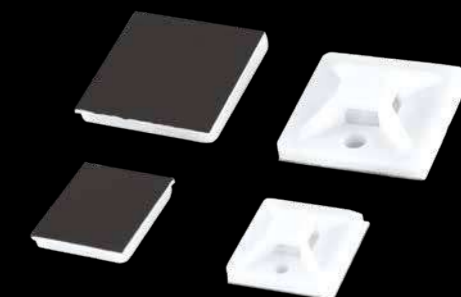

KABELSKE OBUJMICE / CABLE CLIPS

Kom./kutija / Pcs/ctn

1

šifra / art. no. (EAN)	dimenzije / dimensions	boja / color	kom./pak / pcs/pkg
365-301 (EAN 3858890440225)	4-7 mm	●	100
365-302 (EAN 3858890440232)	7-10 mm	●	100
365-303 (EAN 3858890440249)	10-14 mm	●	50



TIPLE OBUJMICE / CABLE FIXING PLUGS

Kom./kutija / Pcs/ctn

200

šifra / art. no. (EAN)	dimenzije / dimensions	boja / color	kom./pak / pcs/pkg
365-311 (EAN 3856024406604)	3-6 mm	●	15
365-312 (EAN 3856024406611)	5-10 mm	●	15
365-313 (EAN 3856024406628)	11-18 mm	●	10

Tiple obujmice - omogućavaju čvrsto i kvalitetno pričvršćivanje kabela na zid
Cable fixing plug enable firm and high-quality fastening of the cable to the wall.

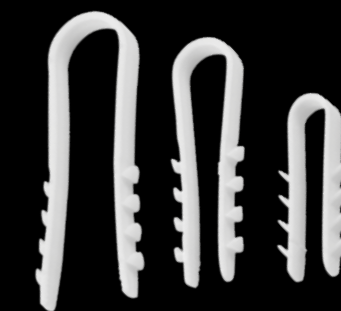



SPOJNI PRIBOR CONNECTION ACCESSORIES

REDNE STEZALJKE / TERMINAL BLOCKS



šifra / art. no. (EAN)	presjek vodiča / wire cross section	boja / color	kom./kutija / pcs/ctn
365-401 (EAN 3858890440256)	2,5 mm²	●	20
365-402 (EAN 3858890440270)	4,0 mm²	●	20
365-403 (EAN 3858890440294)	6,0 mm²	●	20

Max. opterećenje / Max. load
5 A

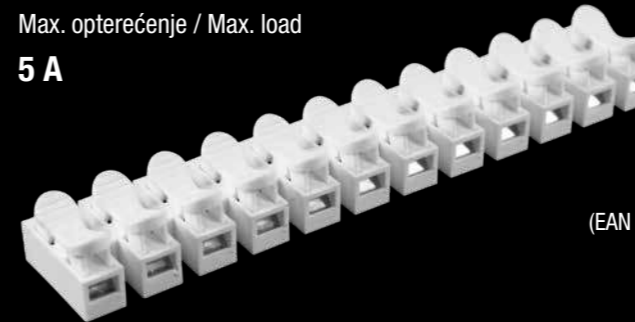

šifra / art. no. (EAN)	presjek vodiča / wire cross section	boja / color	kom./kutija / pcs/ctn
365-409 (EAN 3856024404105)	0,5 - 2,5 mm²	●	10

BRZE KABELNE SPOJNICE ZA PUNU ŽICU / QUICK WIRE CONNECTORS FOR SOLID WIRE



Presjek vodiča / Wire cross section
0,75 - 2,5 mm²

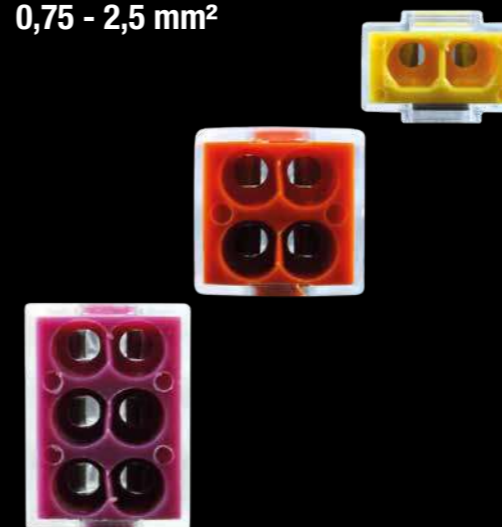

polovi / poles	šifra / art. no. (EAN)	boja / color	kom./pak / pcs/pkg	kom./kutija / pcs/ctn
2	365-464 (EAN 3856024404044)	●	20	84
	365-467 (EAN 3856024404051)	●	50	20
4	365-465 (EAN 3856024404068)	●	20	84
	365-468 (EAN 3856024404075)	●	50	20
6	365-466 (EAN 3856024404082)	●	10	84
	365-469 (EAN 3856024404099)	●	50	20

BRZE KABELSKE SPOJNICE / QUICK WIRE CONNECTORS

Presjek punog vodiča / Solid wire cross section

0,2 - 2,5 mm²

Presjek fleksibilnog vodiča / Stranded wire cross section

0,2 - 4,0 mm²



polovi / poles	šifra / art. no.	kom./pak / pcs/pkg	kom./kutija / pcs/ctn
2	365-450 (EAN 3858890449341)	20	84
	365-454 (EAN 3856024404143)	50	20
3	365-452 (EAN 3858890442465)	10	84
	365-455 (EAN 3856024404150)	50	20
5	365-453 (EAN 3858890442472)	10	84
	365-456 (EAN 3856024404167)	50	20

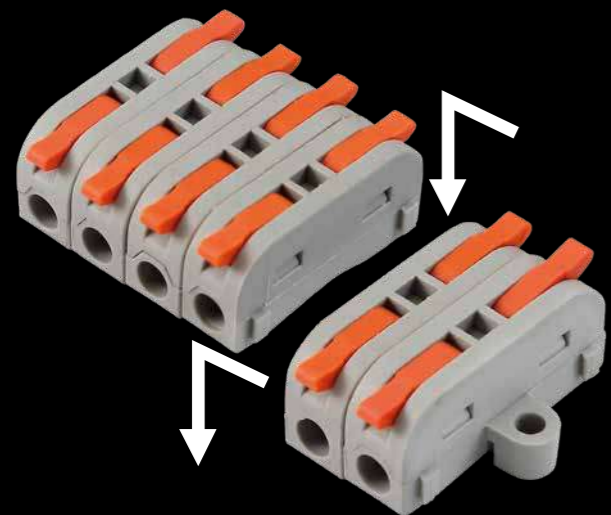

Presjek punog vodiča / Solid wire cross section

0,2 - 2,5 mm²

Presjek fleksibilnog vodiča / Stranded wire cross section

0,2 - 4,0 mm²

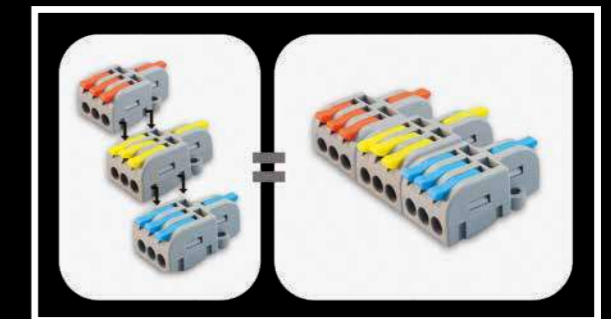

Duljina skinute izolacije
Stripping length indicator



Učvrstite s vijcima
Fastening with screws

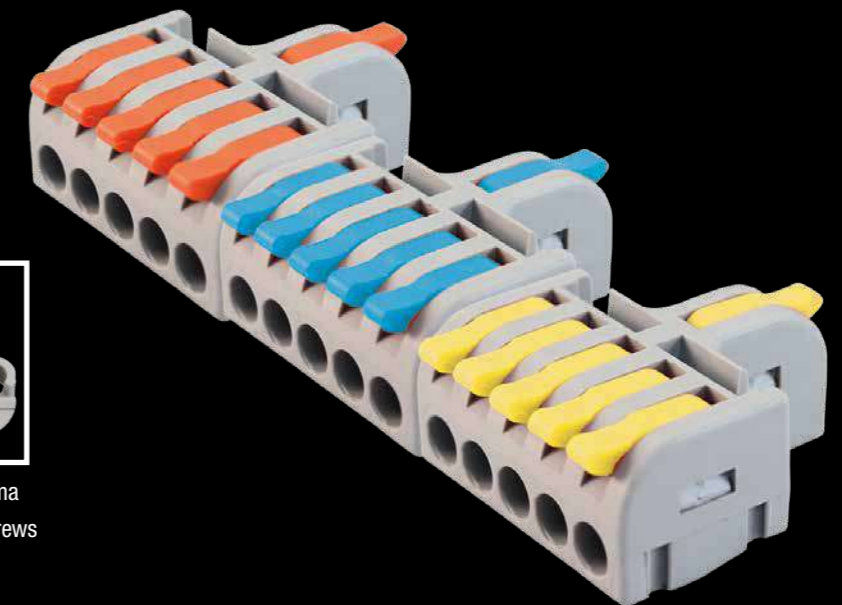

Presjek punog vodiča / Solid wire cross section

0,2 - 2,5 mm²

Presjek fleksibilnog vodiča / Stranded wire cross section

0,2 - 4,0 mm²

polovi / poles	šifra / art. no.	kom./pak / pcs/pkg	kom./kutija / pcs/ctn
2	365-471 (EAN 3856024404112)	10	10

polovi / poles	šifra / art. no.	kom./pak / pcs/pkg	kom./kutija / pcs/ctn
1-2	365-480 (EAN 3856024405836)	9	10
1-3	365-481 (EAN 3856024405843)	9	10
1-5	365-482 (EAN 3856024405850)	9	10

BRZE KABELSKE SPOJNICE / QUICK WIRE CONNECTORS

Presjek punog vodiča / Solid wire cross section

0,2 - 2,5 mm²

Presjek fleksibilnog vodiča / Stranded wire cross section

0,2 - 4,0 mm²



polovi / poles	šifra / art. no.	kom./pak / pcs/pkg	kom./kutija / pcs/ctn
2-2	365-472 (EAN 3856024403931)	10	10
2-4	365-474 (EAN 3856024403955)	5	10
2-6	365-475 (EAN 3856024403948)	5	10

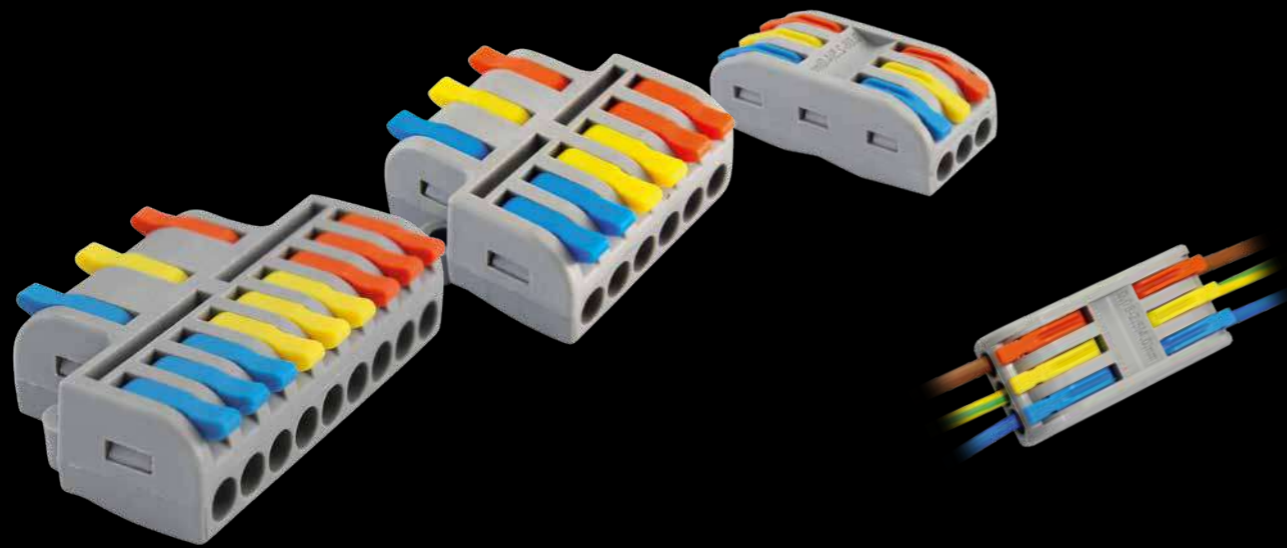

polovi / poles	šifra / art. no.	presjek punog vodiča / solid wire cross section	presjek fleksibilnog vodiča / stranded wire cross section	kom./pak / pcs/pkg	kom./kutija / pcs/ctn
3-3	365-473 (EAN 3856024403924)	0,08 - 2,5 mm²	0,08 - 4,0 mm²	5	10
3-6	365-477 (EAN 3856024404129)	0,2 - 2,5 mm²	0,2 - 4,0 mm²	5	10
3-9	365-478 (EAN 3856024404136)	0,2 - 2,5 mm²	0,2 - 4,0 mm²	5	10

Commel

KABELSKI KONEKTORI IP68 / CABLE CONNECTOR IP68

Presjek punog vodiča / Solid wire cross section

0,08 - 2,5 mm²

Presjek fleksibilnog vodiča / Stranded wire cross section

0,08 - 4 mm²

Stupanj zaštite / IP grade

IP68

Mehanizam s brzom spojnicom za montažu bez odvijača

Quick coupler mechanism for screwless installation

polovi / poles

3

šifra / art. no.

365-906
(EAN 3856024404013)

dimenzije / dimensions

87 mm x 25 mm

kom./kutija / pcs/ctn

10



Presjek vodiča / Wire cross section

0,2 - 1,5 mm²

Stupanj zaštite / IP grade

IP68

Rastavljiv, klik mehanizam za montažu bez odvijača

Reconnectable, Click-on mechanism for screwless installation

polovi / poles

3

šifra / art. no.

365-905
(EAN 3856024404020)

dimenzije / dimensions

82 mm x 22 mm

kom./kutija / pcs/ctn

10



Presjek vodiča / Wire cross section

1 - 2,5 mm²

Stupanj zaštite / IP grade

IP68

polovi / poles

5

šifra / art. no.

365-907
(EAN 3856024404037)

dimenzije / dimensions

80 mm x 85 mm x 25 mm

kom./kutija / pcs/ctn

10



Commel

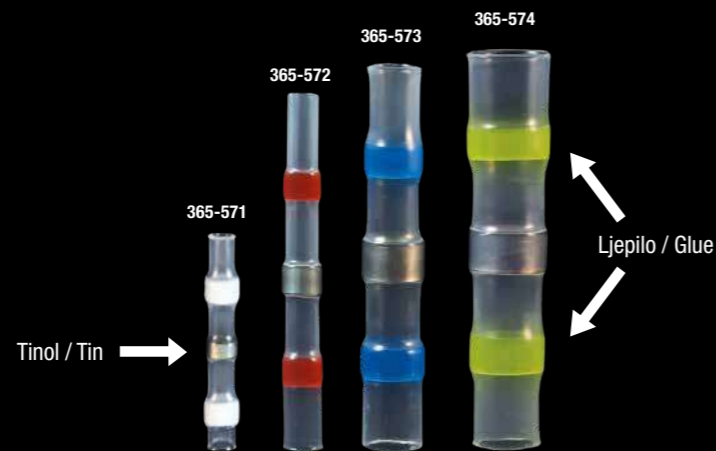
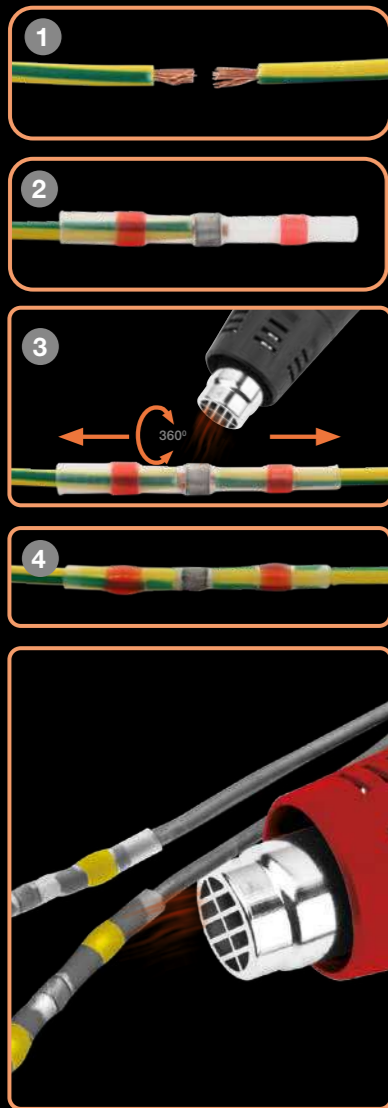

šifra / art. no.	specifikacija / specifications	kom./pak. / pcs./pkg.	kom./kutija / pcs/ctn
365-571 (EAN 3856024406789)	Ø < 0,5 mm²	20	10
365-572 (EAN 3856024406796)	Ø 0,5 - 1,0 mm²	20	10
365-573 (EAN 3856024406802)	Ø 1,5 - 2,5 mm²	20	10
365-574 (EAN 3856024406819)	Ø 4,0 - 6,0 mm²	20	10
365-505 (EAN 3856024405805)	Ø < 0,5 mm² x 25 Ø 0,5 - 1,0 mm² x 40 Ø 1,5 - 2,5 mm² x 25 Ø 4,0 - 6,0 mm² x 10	100	52

Značajke

Za popravak oštećenih kabela električnog uređaja, spajanje vodiča u automobilu ili u profesionalnom industrijskom okruženju
Zalemljen, izoliran i vodootporan spoj u svega nekoliko sekundi

Features

For repairing a damaged electrical appliance cable, connecting wires in a car or in a professional industrial environment
Soldered, insulated and waterproof connection in just a few seconds

Stupanj zaštite / IP grade

IP68

broj uvodnica / number of cable glands

2
3
4
4
6

šifra / art. no.

dimenzije / dimensions

kom./kutija / pcs/ctn

365-921 (EAN 3856024403962)	135 x 70 x 40 mm	10
365-922 (EAN 3856024403979)	135 x 80 x 40 mm	10
365-923 (EAN 3856024403986)	135 x 80 x 40 mm	10
365-924 (EAN 3856024403993)	135 x 100 x 40 mm	10
365-925 (EAN 3856024404006)	135 x 100 x 40 mm	10



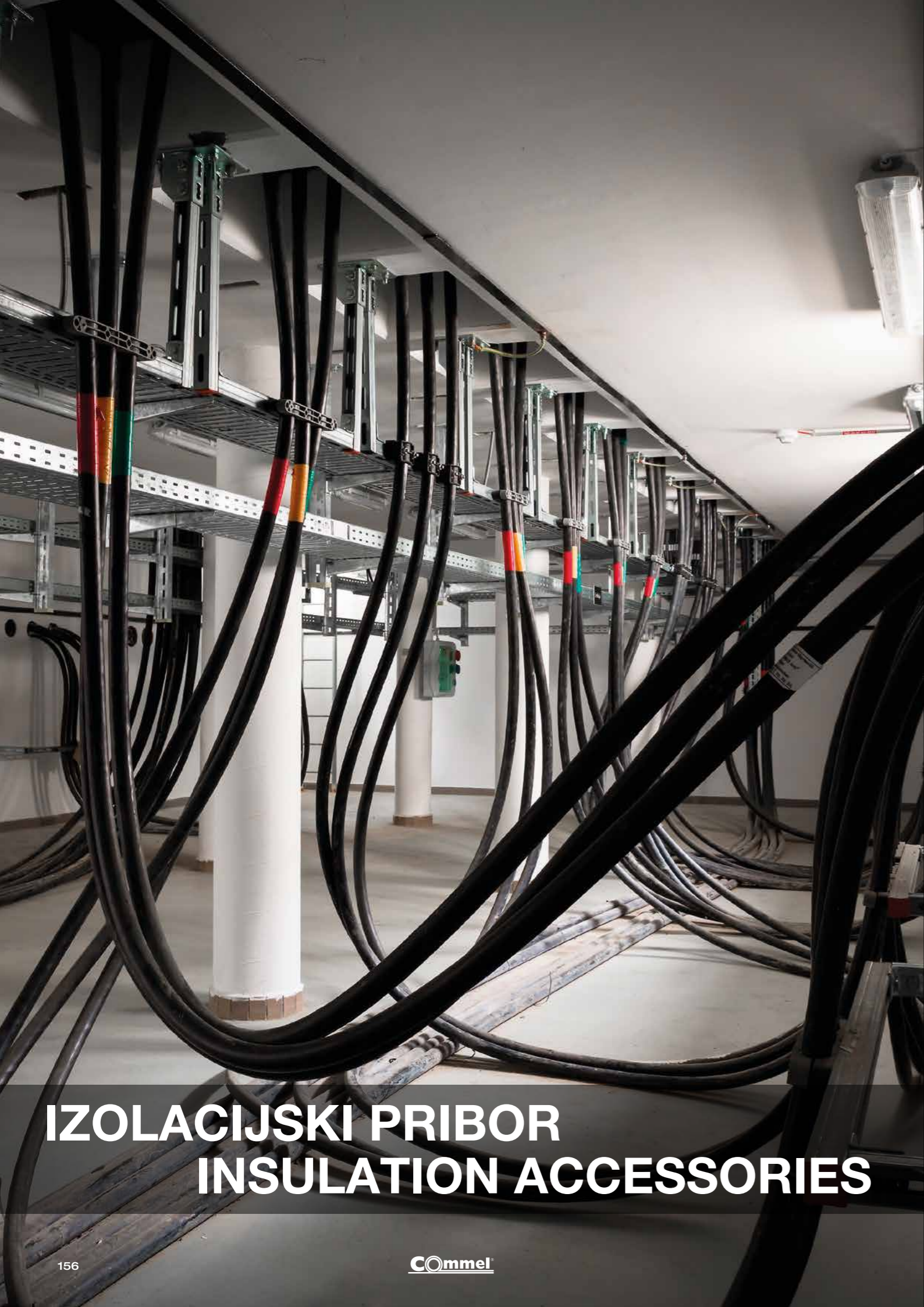

IZOLACIJSKI PRIBOR INSULATION ACCESSORIES

Dužina / Length	Boja / Color	Kom./kutija / Pcs/ctn
1 m		1

šifra / art. no.	promjer / diameter
365-561 <small>(EAN 3858890445909)</small>	2,5 → 1,25 mm
365-562 <small>(EAN 3858890445916)</small>	3,5 → 1,75 mm
365-563 <small>(EAN 3858890445923)</small>	5,0 → 2,5 mm
365-564 <small>(EAN 3858890445930)</small>	7,0 → 3,5 mm
365-565 <small>(EAN 3858890445947)</small>	10,0 → 5,0 mm
365-566 <small>(EAN 3858890445954)</small>	13,0 → 6,5 mm



Dužina / Length	Boja / Color	Kom./pak / Pcs/pkg	Kom./kutija / Pcs/ctn
1 m		10	10

šifra / art. no.	promjer / diameter
365-550 <small>(EAN 3856024403498)</small>	1,5 → 0,75 mm
365-551 <small>(EAN 3858890441758)</small>	2,5 → 1,25 mm
365-552 <small>(EAN 3858890441772)</small>	3,5 → 1,75 mm
365-553 <small>(EAN 3858890441796)</small>	5,0 → 2,5 mm
365-554 <small>(EAN 3858890441819)</small>	7,0 → 3,5 mm
365-555 <small>(EAN 3858890441833)</small>	10,0 → 5,0 mm
365-556 <small>(EAN 3858890441857)</small>	13,0 → 6,5 mm
365-557 <small>(EAN 3858890441871)</small>	20,0 → 10 mm
365-558 <small>(EAN 3858890441895)</small>	25,0 → 12,5 mm



TERMO BUŽIRI / HEAT SHRINK TUBINGS

Dužina / Length
10 cm

Boja / Color
○

Kom./pak / Pcs/pkg
100

Kom./kutija / Pcs/ctn
20



Dužina / Length
10 cm

Boja / Color
○ ● ● ● ● ● ●

Kom./pak / Pcs/pkg
100

Kom./kutija / Pcs/ctn
20

šifra / art. no. specifikacija / specification

1,5 mm x 30
2,5 mm x 30
4,0 mm x 20
6,0 mm x 10
10,0 mm x 6
13,0 mm x 4

365-502
(EAN 3856024406048)

šifra / art. no. specifikacija / specification

1,5 mm x 30
2,5 mm x 30
4,0 mm x 20
6,0 mm x 10
10,0 mm x 6
13,0 mm x 4

365-501
(EAN 3858890440355)

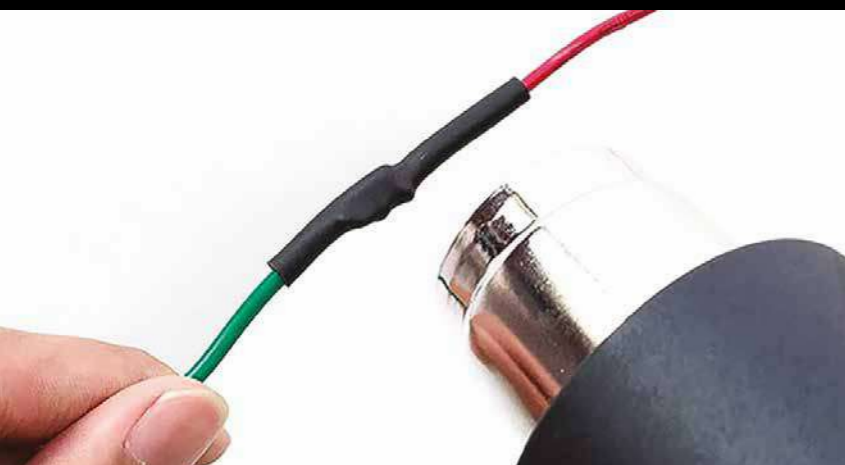

IZOLIR TRAKE / INSULATING TAPES

Debljina / Thickness
0,13 mm

Kom./kutija / Pcs/ctn
10

Samogasive
Fire retardant

U skladu sa standardom EN 60454-2
According to standard EN 60454-2

šifra / art. no. boja / color širina / width dužina / length

365-601 ○ **15 mm 10 m**
(EAN 3858890440379)

365-602 ● **15 mm 10 m**
(EAN 3858890440393)

365-603 ●● **15 mm 10 m**
(EAN 3858890440416)

365-604 ● **15 mm 10 m**
(EAN 3858890440430)

365-605 ○ **15 mm 10 m**
(EAN 3858890441314)

365-651 ○ **19 mm 10 m**
(EAN 3858890440454)

365-652 ● **19 mm 10 m**
(EAN 3858890440478)

365-653 ●● **19 mm 10 m**
(EAN 3858890440492)

365-654 ● **19 mm 10 m**
(EAN 3858890440515)

365-655 ○ **19 mm 10 m**
(EAN 3858890441338)

365-656 ● **19 mm 10 m**
(EAN 3858890449204)

365-657 ● **19 mm 10 m**
(EAN 3858890449211)

365-671 ○ **19 mm 20 m**
(EAN 3856024400091)

365-672 ● **19 mm 20 m**
(EAN 3856024400107)

365-673 ●● **19 mm 20 m**
(EAN 3856024400114)

365-674 ● **19 mm 20 m**
(EAN 3856024400121)

365-675 ○ **19 mm 20 m**
(EAN 3856024400138)

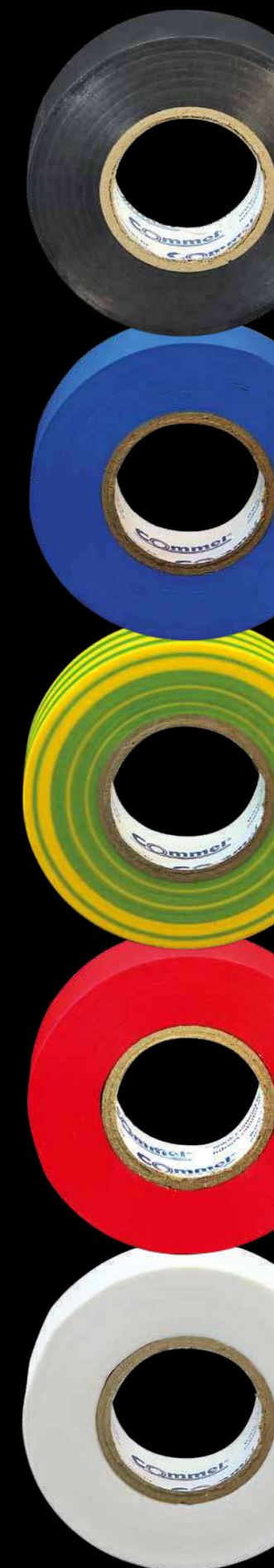



TULJCI I STOPICE WIRE TERMINALS

IZOLIRANI ZAVRŠNI TULJCI / INSULATED CORD END TERMINALS

Kom./pak / Pcs/pkg
100

Kom./kutija / Pcs/ctn
100



šifra / art. no.	dimenzije / dimensions
365-801 (EAN 3858890444940)	0,75 mm²
365-802 (EAN 3858890444957)	1,0 mm²
365-803 (EAN 3858890444964)	1,5 mm²
365-804 (EAN 3858890444971)	2,5 mm²

NEIZOLIRANI ZAVRŠNI TULJCI / NON-INSULATED CORD END TERMINALS

Kom./pak / Pcs/pkg
100

Kom./kutija / Pcs/ctn
100



šifra / art. no.	dimenzije / dimensions
365-805 (EAN 3856024403320)	0,75 mm²
365-806 (EAN 3856024403337)	1,0 mm²
365-807 (EAN 3856024403344)	1,5 mm²
365-808 (EAN 3856024403351)	2,5 mm²

IZOLIRANI ZAVRŠNI TULJCI / INSULATED CORD END TERMINALS

Kom./pak / Pcs/pkg
400

Kom./kutija / Pcs/ctn
1



šifra / art. no.	dimenzije / dimensions
365-701 (EAN 3858890440539)	0,5 mm² x 50
	0,75 mm² x 100
	1,0 mm² x 100
	1,5 mm² x 100
	2,5 mm² x 50

IZOLIRANE SPOJNE ČAHURE / INSULATED CONNECTORS

Kom./pak / Pcs/pkg
20

Kom./kutija / Pcs/ctn
100



šifra / art. no.	dimenzije / dimensions
365-891 (EAN 3856024403306)	0,5 - 1,5 mm²
365-892 (EAN 3856024403313)	1,5 - 2,5 mm²

**OKRUGLE STOPICE /
RING TERMINALS**

Kom./kutija / Pcs/ctn
100



šifra / art. no.	dimenzije / dimensions	kom./pak / pcs/pkg
365-881 (EAN 3858890445152)	0,5 - 1,5 mm² Ø 4,3 mm	25
365-882 (EAN 3858890445169)	0,5 - 1,5 mm² Ø 5,3 mm	25
365-883 (EAN 3858890445176)	1,5 - 2,5 mm² Ø 4,3 mm	25
365-884 (EAN 3858890445183)	1,5 - 2,5 mm² Ø 5,3 mm	25
365-885 (EAN 3858890445190)	4,0 - 6,0 mm² Ø 8,4 mm	10

VILIČASTE STOPICE / SPADE TERMINALS

Kom./pak / Pcs/pkg Kom./kutija / Pcs/ctn
25 **100**



šifra / art. no.	dimenzije / dimensions
365-851 (EAN 3858890445077)	0,5 - 1,5 mm² Ø 4,3 mm
365-852 (EAN 3858890445084)	1,5 - 2,5 mm² Ø 5,3 mm

**UTIKAČI I NATIKAČI ZA ŽICU /
WIRE DISCONNECTS**

Kom./pak / Pcs/pkg Kom./kutija / Pcs/ctn
25 **100**



šifra / art. no.	dimenzije / dimensions
365-811 (EAN 3858890445015)	0,5 - 1,5 mm² 0,8 x 2,8 mm
365-812 (EAN 3858890445053)	0,5 - 1,5 mm² 0,8 x 6,35 mm
365-813 (EAN 3858890445039)	1,5 - 2,5 mm² 0,8 x 4,75 mm

Kom./pak / Pcs/pkg Kom./kutija / Pcs/ctn
25 **100**



šifra / art. no.	dimenzije / dimensions
365-821 (EAN 3858890445022)	0,5 - 1,5 mm² 0,8 x 2,8 mm
365-822 (EAN 3858890445060)	0,5 - 1,5 mm² 0,8 x 6,35 mm
365-823 (EAN 3858890445046)	1,5 - 2,5 mm² 0,8 x 4,75 mm

Kom./pak / Pcs/pkg Kom./kutija / Pcs/ctn
10 + 10 **100**



šifra / art. no.	dimenzije / dimensions
365-831 (EAN 3858890444988)	0,5 - 1,5 mm² 0,8 x 4,75 mm
365-832 (EAN 3858890444995)	0,5 - 1,5 mm² 0,8 x 6,35 mm
365-833 (EAN 3858890445008)	1,5 - 2,5 mm² 0,8 x 4,75 mm

**KUTNI UTIKAČI + NATIKAČI ZA ŽICU /
MALE + FEMALE WIRE DISCONNECTS**

Kom./pak / Pcs/pkg Kom./kutija / Pcs/ctn
25 + 25 **25**

šifra / art. no.	dimenzije / dimensions
365-841 (EAN 3858890445091)	0,5 - 1,5 mm² 0,8 x 6,35 mm
365-842 (EAN 3858890445107)	1,5 - 2,5 mm² 0,8 x 6,35 mm



**IZOLIRANI UTIKAČI I NATIKAČI ZA ŽICU /
INSULATED BULLET TERMINALS**

šifra / art. no.	dimenzije / dimensions	kom./pak / pcs/pkg	kom./kutija / pcs/ctn
365-861 (EAN 3858890445114)	0,5 - 1,5 mm² Ø 4 mm	25	100
365-862 (EAN 3858890445121)	1,5 - 2,5 mm² Ø 5 mm	25	100
365-871 (EAN 3858890445138)	0,5 - 1,5 mm² Ø 4 mm	25	100
365-872 (EAN 3858890445145)	1,5 - 2,5 mm² Ø 5 mm	25	100



SET STOPICA - 18 VRSTA / WIRE TERMINAL SET - 18 TYPES



šifra / art. no. kom./pak / pcs/pkg kom./kutija / pcs/ctn
365-702 **175** **1**
(EAN 3858890445961)



ELEKTRIČARSKI ALATI HAND TOOLS

SET STOPICA S KLIJEŠTIMA / ELECTRICAL PLIERS AND TERMINALS SET



šifra / art. no.
365-751
(EAN 3858890442489)

kom./pak / pcs/pkg
101

kom./kutija / pcs/ctn
10



Skidanje izolacije
Wire stripping

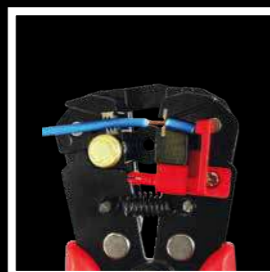

Rezanje
Cutting



Krimpanje
Crimping



šifra / art. no. kom./kutija / pcs/ctn

370-101 **10**
(EAN 3856024403368)

Skidanje izolacije
Wire stripping



Rezanje
Cutting

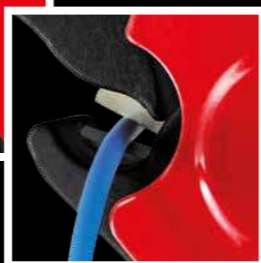

šifra / art. no. kom./kutija / pcs/ctn

370-102 **10**
(EAN 3856024403375)

VDE kliješta / VDE Pliers

1000 V

Materijal / Material
CRV

Standard / Standard
EN/IEC 60900

Značajke / Specs
Soft grip handle

Kom./kutija / Pcs/ctn
6



šifra / art. no. vrsta kliješta / pliers type

370-131
(EAN 3856024404716)

**Kombinirana kliješta /
Combination pliers**

dužina / length

180 mm



šifra / art. no. vrsta kliješta / pliers type

370-132
(EAN 3856024404723)

**Kliješta za bočno sječenje /
Diagonal cutter pliers**

dužina / length

160 mm



šifra / art. no. vrsta kliješta / pliers type

370-133
(EAN 3856024404730)

**Kliješta produžena ravna /
Long nose pliers**

dužina / length

200 mm



šifra / art. no. vrsta kliješta / pliers type

370-134
(EAN 3856024404747)

**Kliješta za skidanje izolacije
/ Wire stripper pliers**

dužina / length

160 mm



šifra / art. no. vrsta kliješta / pliers type

370-135
(EAN 3856024407229)

**Kliješta za sječenje kabela /
Cable cutter pliers**

dužina / length

160 mm



VDE odvijajući / VDE Screwdrivers

1000 V



Materijal / Material
CRV

Standard / Standard
EN/IEC 60900

Značajke / Specs
Soft grip handle

Materijal / Material
CRV

Standard / Standard
EN/IEC 60900

Značajke / Specs
Soft grip handle

VDE odvijajući / VDE Screwdrivers

1000 V



šifra / art. no. (EAN)	tip odvijajača / screwdriver type	kom./kutija / pcs/ctn
370-201 (EAN 3856024406444)	SL 2.5 x 75 mm	12
370-202 (EAN 3856024406451)	SL 3 x 100 mm	12
370-203 (EAN 3856024406468)	SL 3.5 x 100 mm	12
370-204 (EAN 3856024406475)	SL 4 x 100 mm	12
370-205 (EAN 3856024406482)	SL 5.5 x 125 mm	12
370-206 (EAN 3856024406499)	SL 6.5 x 150 mm	12
370-207 (EAN 3856024406505)	SL 8 x 175 mm	6

šifra / art. no. (EAN)	tip odvijajača / screwdriver type	kom./kutija / pcs/ctn
370-211 (EAN 3856024406512)	PH0 3 x 60 mm	12
370-212 (EAN 3856024406529)	PH1 5 x 80 mm	12
370-213 (EAN 3856024406536)	PH2 6 x 100 mm	12
370-214 (EAN 3856024406543)	PH3 8 x 150 mm	6
370-221 (EAN 3856024406550)	PZ0 3 x 60 mm	12
370-222 (EAN 3856024406567)	PZ1 5 x 80 mm	12
370-223 (EAN 3856024406574)	PZ2 6 x 100 mm	12
370-224 (EAN 3856024406581)	PZ3 8 x 150 mm	6

SET VDE ODVIJAČA / VDE SCREWDRIVER SET

VDE odvijači / VDE Screwdrivers

1000 V

Materijal / Material

CRV

Standard / Standard

EN/IEC 60900

Značajke / Specs

Soft grip handle

Kom./pak. / Pcs/pkg

5



šifra / art. no. tip odvijača / screwdriver type

SL 4,0 x 100 mm
SL 5,5 x 125 mm
PH1 5 x 80 mm
PH2 6 x 100 mm
Single-Pole Voltage Tester

370-252
 (EAN 3856024407342)

kom./kutija /pcs/ctn

24

VDE odvijači / VDE Screwdrivers

1000 V

Materijal / Material

CRV

Standard / Standard

EN/IEC 60900

Značajke / Specs

Soft grip handle

Kom./pak. / Pcs/pkg

6



šifra / art. no. tip odvijača / screwdriver type

SL 2,5 x 75 mm
SL 4,0 x 100 mm
SL 5,5 x 125 mm
PH0 3 x 60 mm
PH1 5 x 80 mm
PH2 6 x 100 mm

370-251
 (EAN 3856024406598)

kom./kutija /pcs/ctn

24

SET VDE ODVIJAČA, 13 DIJELOVA / VDE SCREWDRIVER SET, 13 PCS

VDE odvijači / VDE Screwdrivers

1000 V

Materijal / Material
CRV

Standard / Standard
EN/IEC 60900

Značajke / Specs
Soft grip handle

Kom./pak. / Pcs/pkg
13

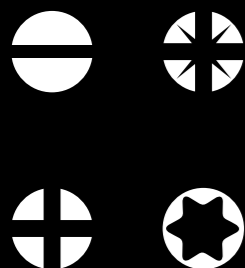

šifra / art. no. tip odvijača / screwdriver type

kom./kutija / pcs/ctn

**SL 3 x 100 mm; SL 4 x 100 mm;
SL 5.5 x 100 mm; SL 6.5 x 100 mm
PH1 x 80 mm; PH2 x 100 mm
PZ1 x 80 mm; PZ2 x 100 mm
T10 x 100 mm; T15 x 100 mm; T20 x 100 mm
Single-Pole Voltage Tester 140 mm
Screwdriver Handle**

12

370-253
(EAN 3856024407359)

Materijal / Material
Najlon / Nylon

Boja / Color

Kom./kutija / Pcs/ctn
5



Promjer / Diameter	šifra / art. no. (EAN)	dužina / length
3 mm	370-301 (EAN 3856024403665)	5 m
	370-302 (EAN 3856024403672)	10 m
	370-303 (EAN 3856024403689)	20 m

Promjer / Diameter	šifra / art. no. (EAN)	dužina / length
4 mm	370-305 (EAN 3856024404655)	5 m
	370-306 (EAN 3856024404662)	10 m
	370-307 (EAN 3856024404679)	20 m

ČELIČNA SAJLA ZA UVLAČENJE KABELA / STEEL FISH TAPE

Materijal / Material
Čelik / Steel

Boja / Color

Kom./kutija / Pcs/ctn
5



Promjer / Diameter	šifra / art. no. (EAN)	dužina / length
3 mm	370-311 (EAN 3856024403696)	5 m
	370-312 (EAN 3856024403702)	10 m
	370-313 (EAN 3856024403719)	20 m

Promjer / Diameter	šifra / art. no. (EAN)	dužina / length
4 mm	370-315 (EAN 3856024404686)	5 m
	370-316 (EAN 3856024404693)	10 m
	370-317 (EAN 3856024404709)	20 m



LED ŽARULJE LED BULBS

Životni vijek / Lifespan **15.000 h** Nazivni napon / Input voltage **220-240 V~** Indeks uzvrata boje / CRI **RA >80** Kom./kutija / Pcs/ctn **10**

470 lm

šifra / art. no.	snaga / power	temperatura svjetla / color temperature	Tip / Type
305-711 (EAN 3856024404808)	4,9 W	3000 K	A55 / E27
305-811 (EAN 3856024404815)	4,9 W	4000 K	
305-911 (EAN 3856024404822)	4,9 W	6500 K	

806 lm

šifra / art. no.	snaga / power	temperatura svjetla / color temperature	Tip / Type
305-712 (EAN 3856024404839)	8,5 W	3000 K	A60 / E27
305-812 (EAN 3856024404846)	8,5 W	4000 K	
305-912 (EAN 3856024404853)	8,5 W	6500 K	

1055 lm

šifra / art. no.	snaga / power	temperatura svjetla / color temperature	Tip / Type
305-713 (EAN 3856024404860)	9,5 W	3000 K	
305-813 (EAN 3856024404877)	9,5 W	4000 K	
305-913 (EAN 3856024404884)	9,5 W	6500 K	

1350 lm

šifra / art. no.	snaga / power	temperatura svjetla / color temperature	Tip / Type
305-714 (EAN 3856024404891)	11 W	3000 K	
305-814 (EAN 3856024404907)	11 W	4000 K	
305-914 (EAN 3856024404914)	11 W	6500 K	

1500 lm

šifra / art. no.	snaga / power	temperatura svjetla / color temperature	Tip / Type
305-715 (EAN 3856024404921)	12 W	3000 K	
305-815 (EAN 3856024404938)	12 W	4000 K	
305-915 (EAN 3856024404945)	12 W	6500 K	



Životni vijek / Lifespan
15.000 h

Nazivni napon / Input voltage
220-240 V~

Indeks uzvrata boje / CRI
RA >80

Kom./kutija / Pcs/ctn
10

Životni vijek / Lifespan
15.000 h

Indeks uzvrata boje / CRI
RA >80

Nazivni napon / Input voltage
220-240 V~

Kom./kutija / Pcs/ctn
10

1800 lm

šifra / art. no.
305-716
(EAN 3856024404952)

snaga / power
16 W

temperatura svjetla /
color temperature
3000 K 

305-816
(EAN 3856024404969)

16 W

4000 K 

305-916
(EAN 3856024404976)

16 W

6500 K 

2000 lm

305-717
(EAN 3856024404983)

17 W

3000 K 

305-817
(EAN 3856024404990)

17 W

4000 K 

305-917
(EAN 3856024405003)

17 W

6500 K 

Tip / Type

A65 / E27



806 lm

šifra / art. no.

305-745
(EAN 3856024405263)

snaga / power

8 W

temperatura svjetla /
color temperature

3000 K 

305-845
(EAN 3856024405270)

8 W

4000 K 

Tip / Type

R63 / E27



250 lm

šifra / art. no.

305-725
(EAN 3856024405119)

snaga / power

3 W

temperatura svjetla /
color temperature

3000 K 

305-825
(EAN 3856024405126)

3 W

4000 K 

470 lm

305-726
(EAN 3856024405133)

4,9 W

3000 K 

305-826
(EAN 3856024405140)

4,9 W

4000 K 

305-926
(EAN 3856024405157)

4,9 W

6500 K 

806 lm

305-727
(EAN 3856024405164)

8 W

3000 K 

305-827
(EAN 3856024405171)

8 W

4000 K 

Tip / Type

G45 / E27



2500 lm

šifra / art. no.
305-718
(EAN 3856024405010)

snaga / power
20 W

temperatura svjetla /
color temperature
3000 K 

305-818
(EAN 3856024405027)

20 W

4000 K 

305-918
(EAN 3856024405034)

20 W

6500 K 

Tip / Type

A80 / E27



Životni vijek / Lifespan
15.000 h

Nazivni napon / Input voltage
220-240 V~

Indeks uzvrata boje / CRI
RA >80

Kom./kutija / Pcs/ctn
10



Tip / Type

C37 / E14

470 lm

šifra / art. no.	snaga / power	temperatura svjetla / color temperature
305-731 (EAN 3856024405188)	4,9 W	3000 K
305-831 (EAN 3856024405195)	4,9 W	4000 K
305-931 (EAN 3856024405201)	4,9 W	6500 K

806 lm

305-732 (EAN 3856024405218)	8 W	3000 K
305-832 (EAN 3856024405225)	8 W	4000 K
305-932 (EAN 3856024405232)	8 W	6500 K

Tip / Type

R50 / E14

470 lm

šifra / art. no.	snaga / power	temperatura svjetla / color temperature
305-741 (EAN 3856024405249)	5 W	3000 K
305-841 (EAN 3856024405256)	5 W	4000 K



Commel

Životni vijek / Lifespan
15.000 h

Nazivni napon / Input voltage
220-240 V~

Indeks uzvrata boje / CRI
RA >80

Kom./kutija / Pcs/ctn
10

šifra / art. no.	snaga / power	temperatura svjetla / color temperature
305-721 (EAN 3856024405041)	3 W	3000 K
305-821 (EAN 3856024405058)	3 W	4000 K

250 lm

470 lm

806 lm

305-722 (EAN 3856024405065)	4,9 W	3000 K
305-822 (EAN 3856024405072)	4,9 W	4000 K
305-922 (EAN 3856024405089)	4,9 W	6500 K
305-723 (EAN 3856024405096)	8 W	3000 K
305-823 (EAN 3856024405102)	8 W	4000 K

Tip / Type

G45 / E14



Životni vijek / Lifespan
15.000 h

Nazivni napon / Input voltage
12 V

Indeks uzvrata boje / CRI
RA >80

Kom./kutija / Pcs/ctn
10

500 lm

šifra / art. no.	snaga / power	temperatura svjetla / color temperature
305-781 (EAN 3856024405423)	6 W	3000 K
305-881 (EAN 3856024405430)	6 W	4000 K

Tip / Type

MR16 / GU5.3



Commel

Životni vijek / Lifespan
15.000 h

Nazivni napon / Input voltage
220-240 V~

Indeks uzvrata boje / CRI
RA >80

Kom./kutija / Pcs/ctn
10

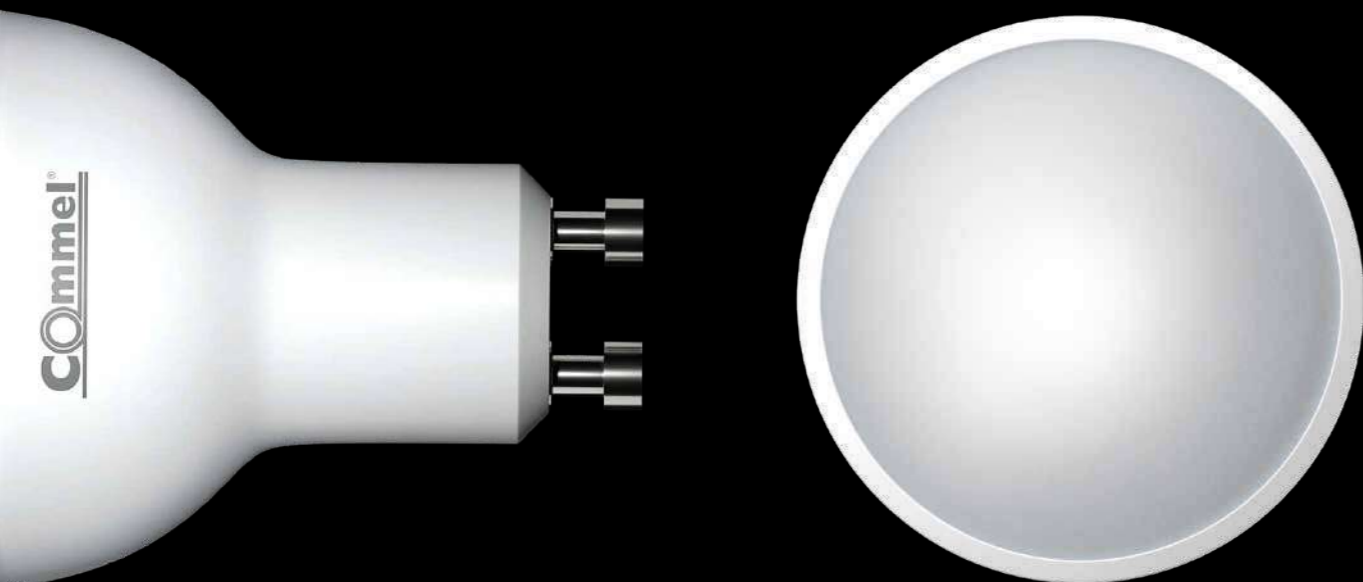

Tip / Type
GU10

250 lm

šifra / art. no.
305-751
(EAN 3856024405287)

snaga / power
3 W

temperatura svjetla /
color temperature
3000 K

šifra / art. no.
305-752
(EAN 3856024405294)

4,9 W

3000 K

šifra / art. no.
305-852
(EAN 3856024405300)

4,9 W

4000 K

šifra / art. no.
305-952
(EAN 3856024405317)

4,9 W

6500 K

600 lm

šifra / art. no.
305-753
(EAN 3856024405324)

7 W

3000 K

šifra / art. no.
305-853
(EAN 3856024405331)

7 W

4000 K

šifra / art. no.
305-953
(EAN 3856024405348)

7 W

6500 K

Životni vijek / Lifespan
15.000 h

Nazivni napon / Input voltage
12 V

Indeks uzvrata boje / CRI
RA >80

Kom./kutija / Pcs/ctn
20

180 lm

šifra / art. no.
305-771
(EAN 3856024405416)

snaga / power
1,8 W

temperatura svjetla /
color temperature
3000 K

Tip / Type

G4



Životni vijek / Lifespan
15.000 h

Nazivni napon / Input voltage
220-240 V~

Indeks uzvrata boje / CRI
RA >80

Kom./kutija / Pcs/ctn
20

315 lm

šifra / art. no.
305-761
(EAN 3856024405355)

snaga / power
3,5 W

temperatura svjetla /
color temperature
3000 K

Tip / Type

G9

šifra / art. no.
305-861
(EAN 3856024405362)

3,5 W

4000 K

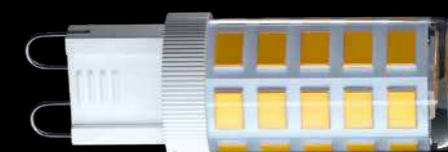

470 lm

šifra / art. no.
305-762
(EAN 3856024405379)

4,5 W

3000 K

šifra / art. no.
305-862
(EAN 3856024405386)

4,5 W

4000 K



600 lm

šifra / art. no.
305-763
(EAN 3856024405393)

6 W

3000 K

šifra / art. no.
305-863
(EAN 3856024405409)

6 W

4000 K

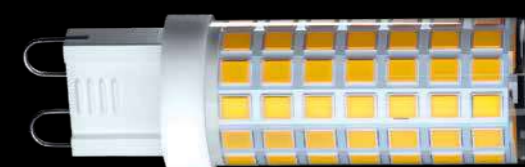

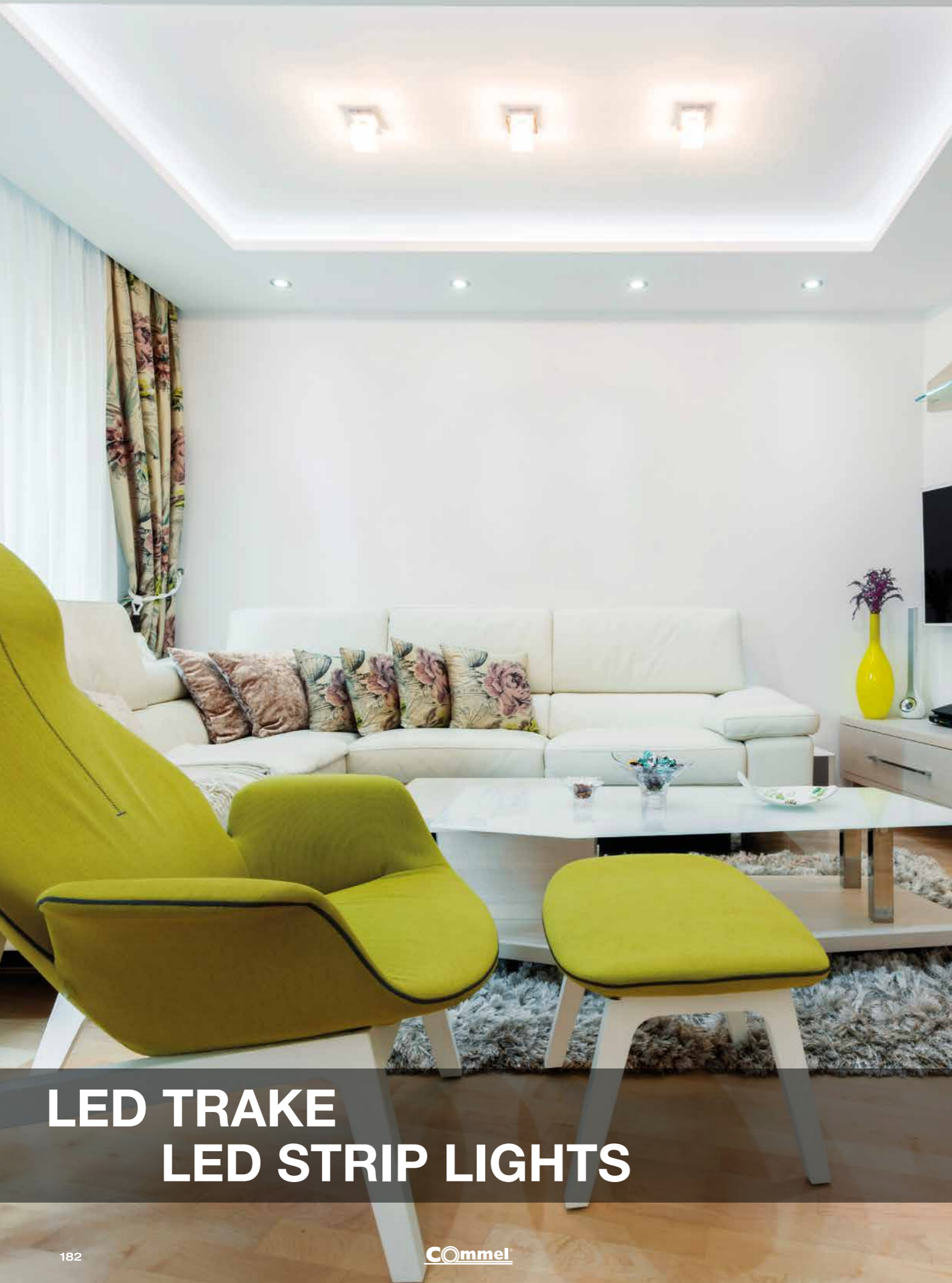

LED TRAKE LED STRIP LIGHTS



Životni vijek / Lifespan **15.000 h** Nazivni napon / Input voltage **12 V** Stupanj zaštite / IP grade **IP65** Kom./kutija / Pcs/ctn **20**

šifra / art. no.	temperatura svjetla / color Temperature	dužina / length	broj LED chipova / number of LED chips	daljinski upravljač / remote control
405-203 (EAN 3858890440638)	RGB	3 m	180/m	+
405-205 (EAN 3858890440652)	RGB	5 m	300/m	+



Životni vijek / Lifespan **15.000 h** Nazivni napon / Input voltage **12 V** Stupanj zaštite / IP grade **IP65** Kom./kutija / Pcs/ctn **20**

šifra / art. no.	temperatura svjetla / color Temperature	dužina / length	broj LED chipova / number of LED chips	daljinski upravljač / remote control
405-103 (EAN 3858890440577)	6500 K	3 m	180/m	-
405-105 (EAN 3858890440591)	6500 K	5 m	300/m	-

Životni vijek / Lifespan
30.000 h

Nazivni napon / Input voltage
24 V

Stupanj zaštite / IP grade
IP20

Kom./kutija / Pcs/ctn
20

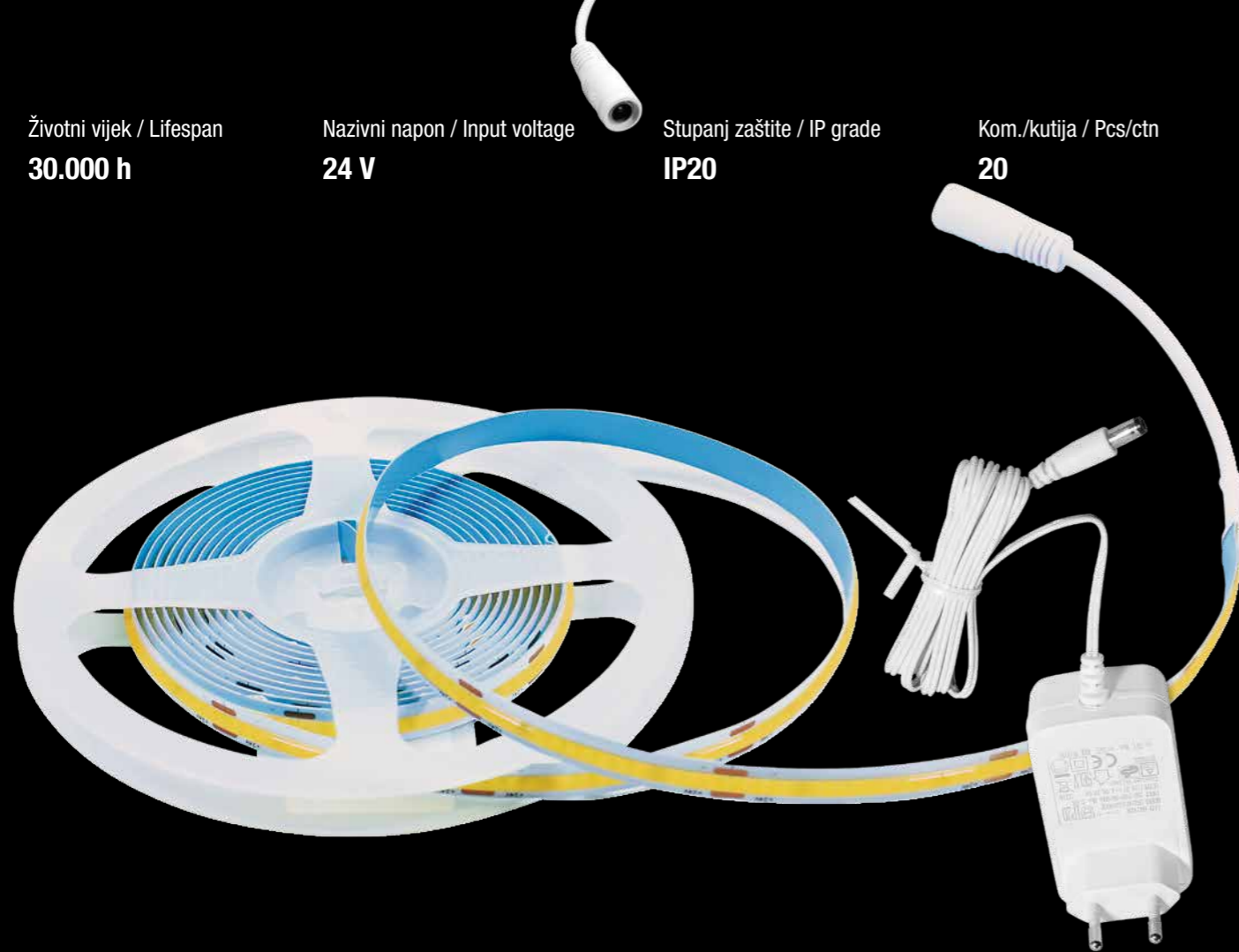

Životni vijek / Lifespan
20.000 h

Nazivni napon / Input voltage
220-240 V~

Stupanj zaštite / IP grade
IP44

Kom./kutija / Pcs/ctn
6

šifra / art. no.	temperatura svjetla / color Temperature	dužina / length	svjetlosni tok po m / luminous flux per m	snaga / power	broj LED chipova / number of LED chips	šifra / art. no.	temperatura svjetla / color Temperature	dužina / length	snaga / power	broj LED chipova / number of LED chips	daljinski upravljač / remote control
405-163 (EAN 3856024406697)	4000 K	3 m	800 lm	8 W/m	320/m	405-405 (EAN 3856024402002)	RGB	5 m	24 W	300	+
405-165 (EAN 3856024406703)	4000 K	5 m	800 lm	8 W/m	320/m						

šifra / art. no.	temperatura svjetla / color Temperature	dužina / length	svjetlosni tok po m / luminous flux per m	snaga / power	broj LED chipova / number of LED chips
405-163 (EAN 3856024406697)	4000 K	3 m	800 lm	8 W/m	320/m
405-165 (EAN 3856024406703)	4000 K	5 m	800 lm	8 W/m	320/m

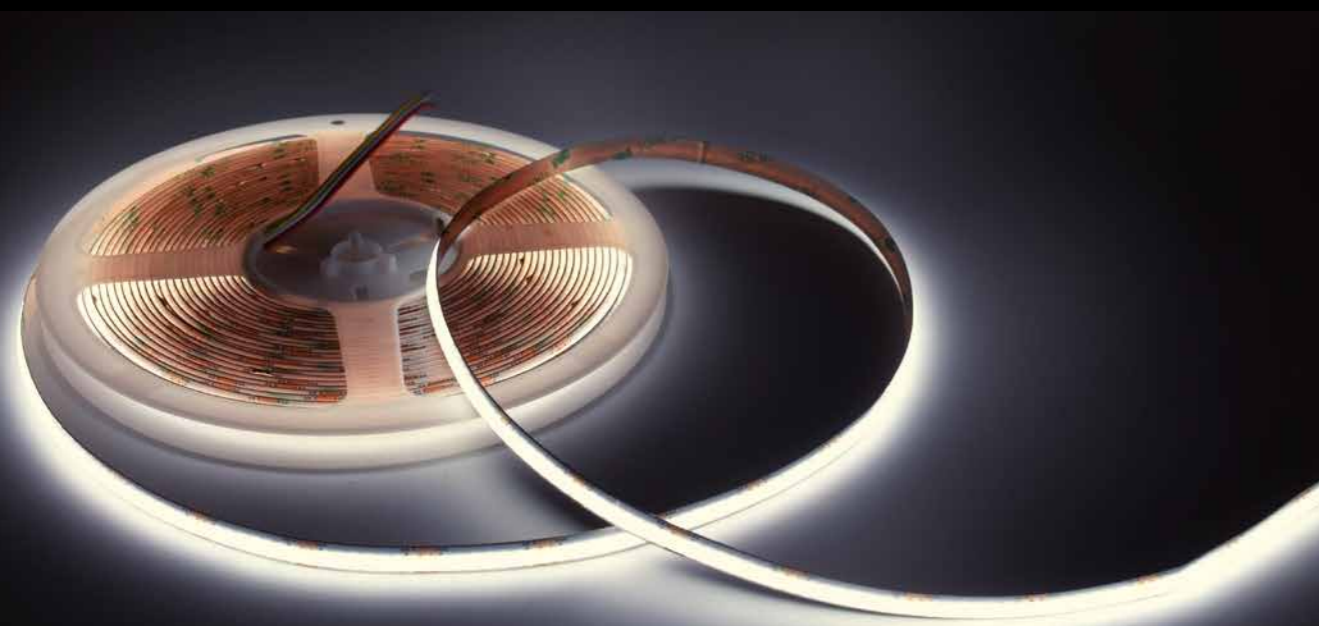



ZIDNE I STROPNE LED SVJETILJKE LED UNDER CABINET LIGHT FIXTURES

Nazivni napon / Input voltage
220 - 240 V~ 50 Hz

Indeks uzvrata boje / CRI
RA >80

Kom./kutija / Pcs/ctn
30

Životni vijek / Lifespan
30.000 h

Stupanj zaštite / IP grade
IP20



	šifra / art. no. (EAN)	svjetlosni tok svjetiljke / luminaire luminous flux	svjetlosni tok izvora svjetlosti / light source luminous flux	temperatura svjetla / color temperature	dimenzije / dimensions
4 W	406-205 (EAN 3858890448610)	400 lm	480 lm	6500 K	282 x 21 x 31 mm
	406-215 (EAN 3858890448658)	400 lm	480 lm	4000 K	282 x 21 x 31 mm
7 W	406-206 (EAN 3858890448627)	700 lm	840 lm	6500 K	582 x 21 x 31 mm
	406-216 (EAN 3858890448665)	700 lm	840 lm	4000 K	582 x 21 x 31 mm
10 W	406-207 (EAN 3858890448634)	1000 lm	1200 lm	6500 K	882 x 21 x 31 mm
	406-217 (EAN 3858890448672)	1000 lm	1200 lm	4000 K	882 x 21 x 31 mm
14 W	406-208 (EAN 3858890448641)	1400 lm	1680 lm	6500 K	1182 x 21 x 31 mm
	406-218 (EAN 3858890448689)	1400 lm	1680 lm	4000 K	1182 x 21 x 31 mm

Značajke
Mogućnost serijskog spajanja

Features
Possibility of serial connection with connector

Priključni kabel s utikačem je uključen u pakiranje

Connection cable with plug included in the package

PC kućište, sa sklopkom

PC housing, On/off switch

Nazivni napon / Input voltage
220- 240 V~50/60 Hz

Indeks uzvrata boje / CRI
RA >80

Kom./kutija / Pcs/ctn
20

Životni vijek / Lifespan
30.000 h

Stupanj zaštite / IP grade
IP20



Nosač svjetiljke
Lamp mounting clip

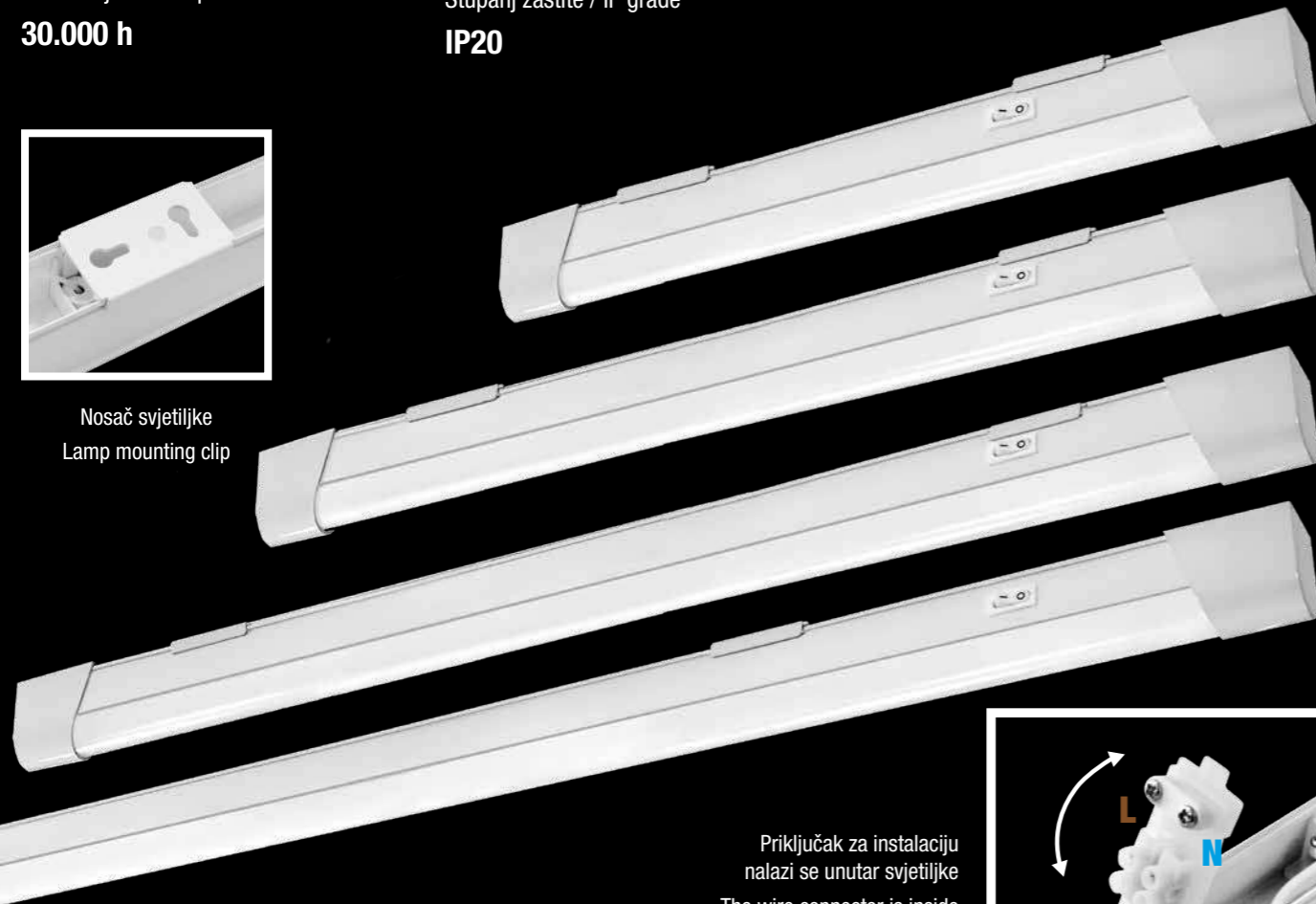

Priključak za instalaciju nalazi se unutar svjetiljke
The wire connector is inside the lamp housing

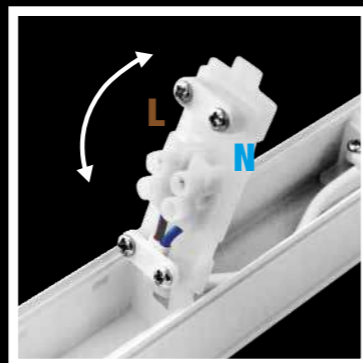

šifra / art. no.

snaga / power

svjetlosni tok svjetiljke / luminaire luminous flux

temperatura svjetla / color temperature

dimenzije / dimensions

406-221
(EAN 3856024406376)

5 W

1 x 600 lm

4000 K

350 x 44 x 29 mm

406-222
(EAN 3856024406383)

10 W

1 x 1200 lm

4000 K

585 x 44 x 29 mm

406-223
(EAN 3856024406390)

15 W

1 x 1800 lm

4000 K

934 x 44 x 29 mm

406-224
(EAN 3856024406406)

20 W

1 x 2400 lm

4000 K

1234 x 44 x 29 mm

Značajke
Slim dizajn
Bez vidljivih kabela

Features
Slim design
No visible wires

MULTIFUNKCIONALNA LED CIJEV / MULTIFUNCTIONAL LED TUBE

Nazivni napon / Input voltage
220- 240 V~50/60 Hz

Duljina kabel / Cable length
1,8 m

Stupanj zaštite / IP grade
IP20

Kom./kutija / Pcs/ctn
8

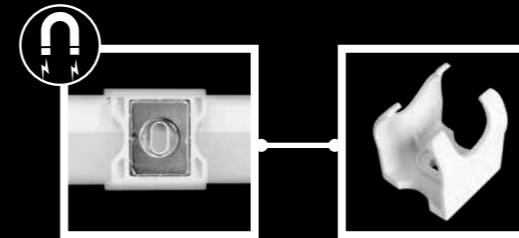

Magnetni držač s rupom za vijak
Magnet clip with mounting hole

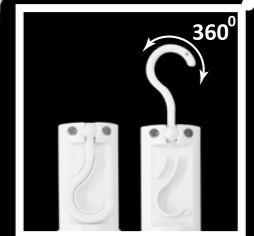

Rotirajuća kuka
Rotating hanger

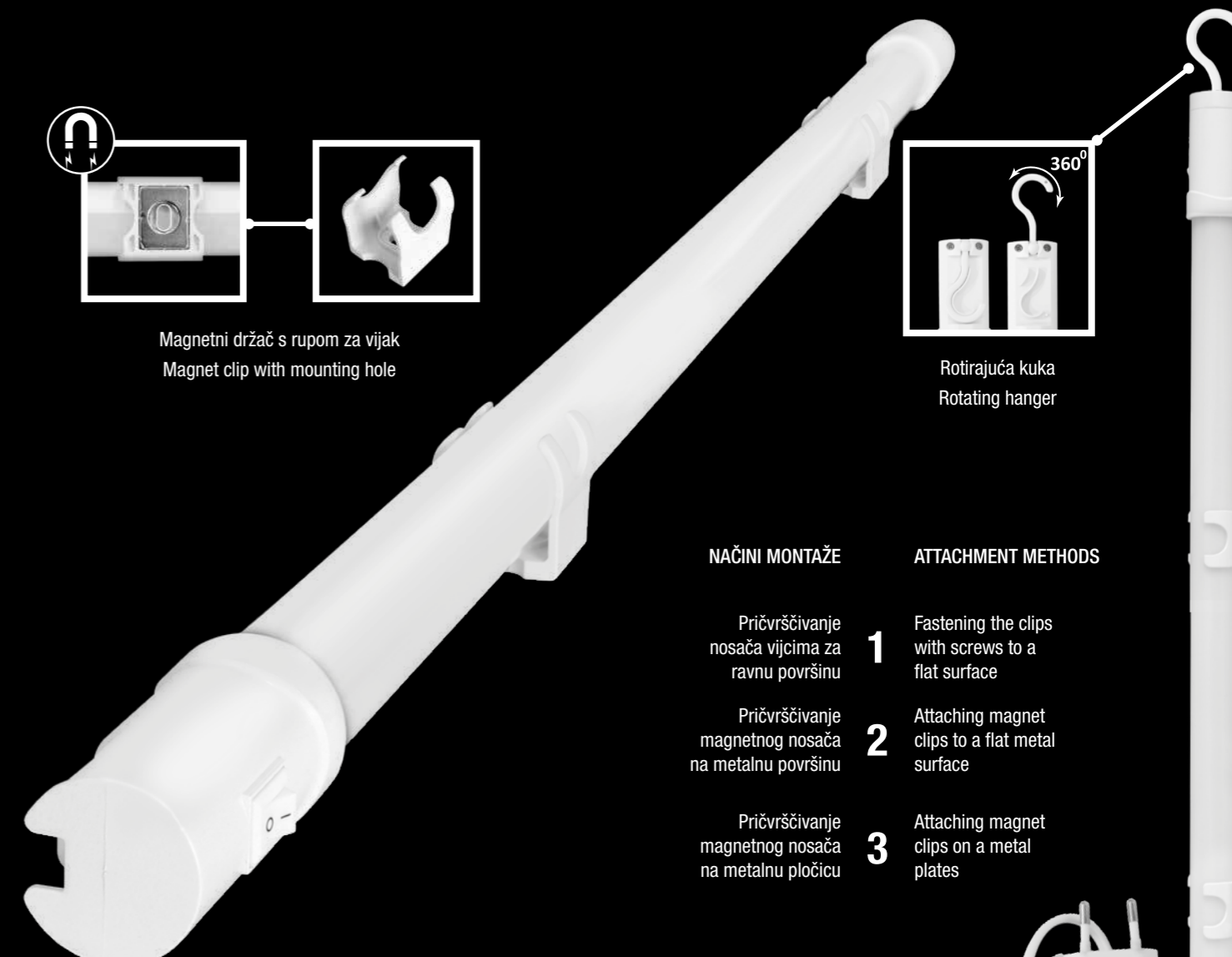

NAČINI MONTAŽE

ATTACHMENT METHODS

- 1** Pričvršćivanje nosača vijcima za ravnu površinu
Fastening the clips with screws to a flat surface
- 2** Pričvršćivanje magnetnog nosača na metalnu površinu
Attaching magnet clips to a flat metal surface
- 3** Pričvršćivanje magnetnog nosača na metalnu pločicu
Attaching magnet clips on a metal plates



šifra / art. no.
406-601
(EAN 3856024406017)

snaga / power
13 W

svjetlosni tok svjetiljke / luminaire luminous flux
1 x 1300 lm

temperatura svjetla / color temperature
4000 K

dimenzije / dimensions
900 x 35 x 36 mm

Nazivni napon / Input voltage
100 - 240 V~ 50/60 Hz

Životni vijek / Lifespan
30.000 h

Stupanj zaštite / IP grade
IP20

Temperatura svjetla / Color temperature
4000 K

Indeks uzvrata boje / CRI
RA >80

Kom./kutija / Pcs/ctn
20

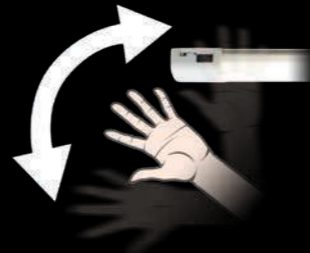

Nazivni napon / Input voltage
220 - 240 V~ 50/60 Hz

Indeks uzvrata boje / CRI
RA >80

Temperatura svjetla / Color temperature
4000 K

Stupanj zaštite / IP grade
IP20

Životni vijek / Lifespan
30.000 h

Kom./kutija / Pcs/ctn
20

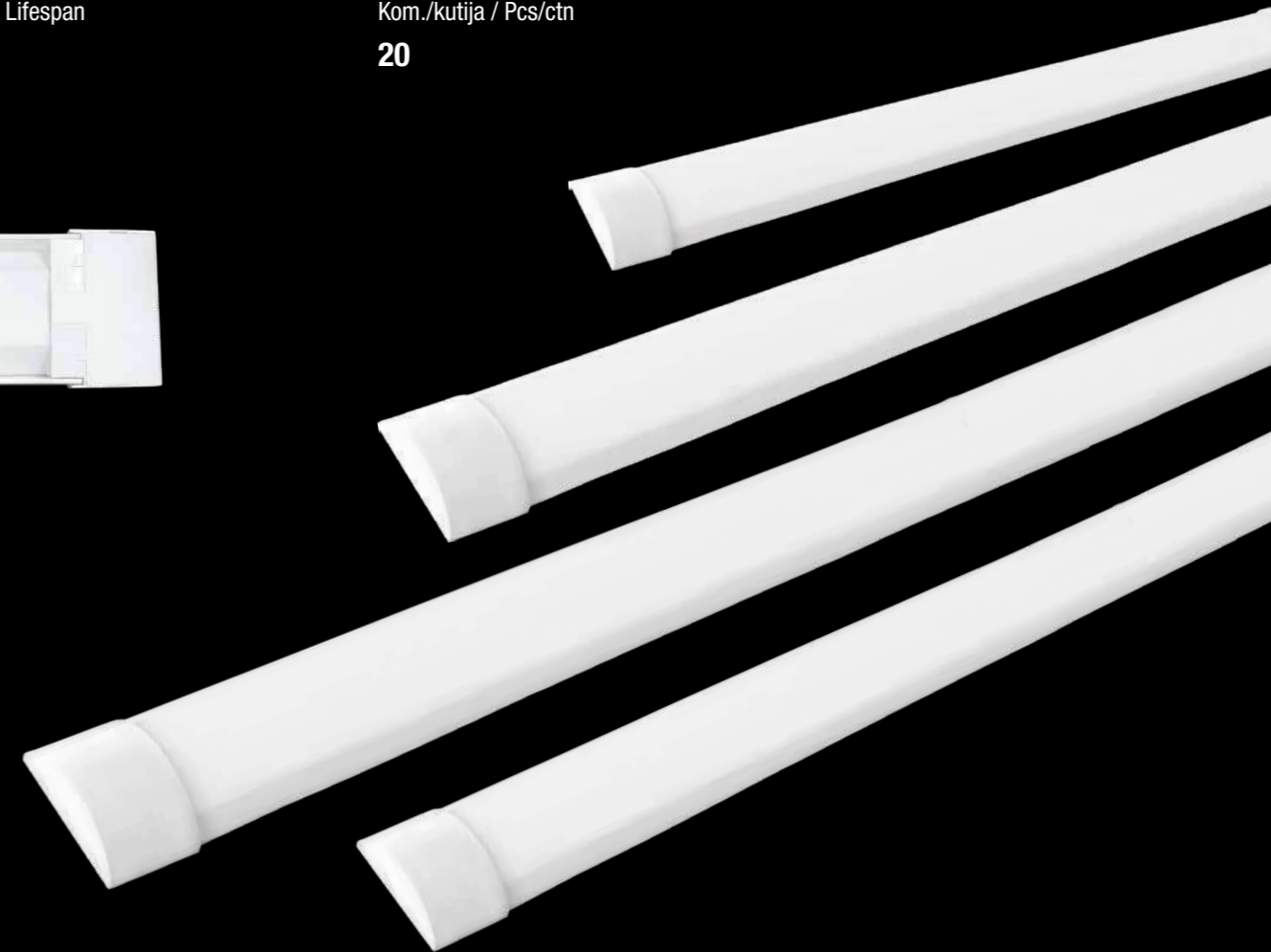

šifra / art. no.	snaga / power	svjetlosni tok svjetiljke / luminaire luminous flux	svjetlosni tok izvora svjetlosti / light source luminous flux	dimenzije / dimensions
406-501 (EAN 3858890449969)	3 W	210 lm	280 lm	325 x 25 x 14 mm
406-502 (EAN 3858890449976)	5.5 W	400 lm	550 lm	525 x 25 x 14 mm
406-503 (EAN 3858890449983)	9.5 W	680 lm	920 lm	940 x 25 x 14 mm

Značajke
Detektor pokreta - uključivanje / isključivanje pokretom ruke
Mogućnost ugradnje u ormar - automatsko uključivanje prilikom otvaranja vrata

Features
Motion detector - turning ON / OFF by hand movement
Suitable for installation inside cabinet - turning ON when door is opening

šifra / art. no.	snaga / power	svjetlosni tok svjetiljke / luminaire luminous flux	svjetlosni tok izvora svjetlosti / light source luminous flux	dimenzije / dimensions
406-261 (EAN 3856024402521)	9 W	900 lm	1000 lm	300 x 25 x 75 mm
406-262 (EAN 3856024402538)	18 W	1800 lm	2200 lm	600 x 25 x 75 mm
406-263 (EAN 3856024402545)	27 W	2500 lm	3400 lm	900 x 25 x 75 mm
406-264 (EAN 3856024402569)	36 W	3400 lm	4500 lm	1200 x 25 x 75 mm



ZIDNE I STROPNE SVJETILJKE BULKHEAD LIGHT FIXTURES

Nazivni napon / Input voltage
230 V~ 50 Hz

Grlo / Lamp holder
E27

Materijal baze / Base material
plastika / plastic

Kom./kutija / Pcs/ctn
12

331-202



331-201



331-205



331-111

331-113

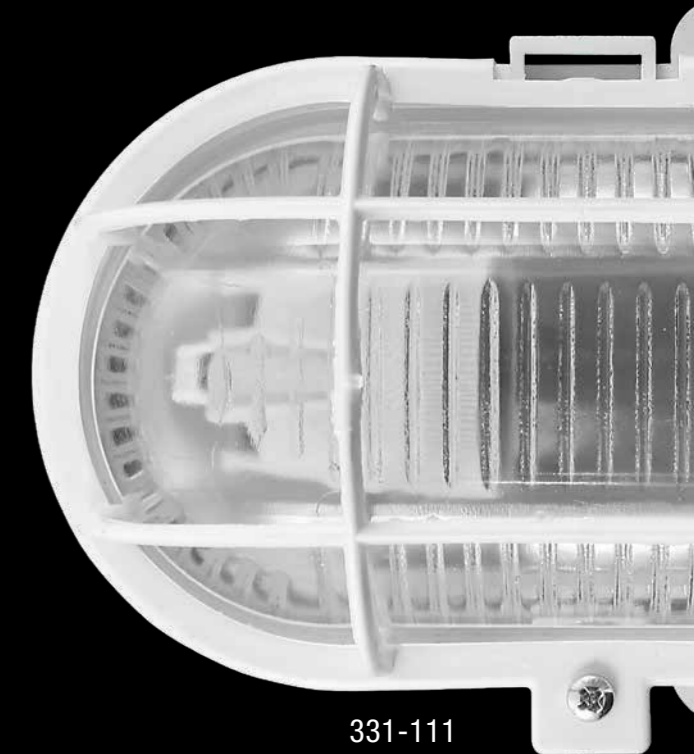

331-111

Šifra / art. no.	boja / color	max snaga / max power	materijal difuzora / diffuser material	stupanj zaštite / IP grade	dimenzije / dimensions
331-202 (EAN 3856024405676)	○	40 W	plastika / plastic	IP44	170 x 125 x 115 mm
331-201 (EAN 3856024402286)	○	60 W	staklo / glass	IP54	170 x 125 x 115 mm
331-205 (EAN 3856024402514)	○	100 W	staklo / glass	IP44	195 x 135 x 115 mm
331-111 (EAN 3856024403726)	○	60 W	staklo / glass	IP54	170 x 125 x 115 mm
331-112 (EAN 3856024403733)	●	60 W	staklo / glass	IP54	170 x 125 x 115 mm
331-113 (EAN 3856024403740)	○	60 W	staklo / glass	IP54	170 x 125 x 115 mm



LED PLAFONJERE LED CEILING LAMPS



Nazivni napon / Input voltage
220-240 V~ 50/60 Hz

Životni vijek / Lifespan
25.000 h

Stupanj zaštite / IP grade
IP20

Temperatura svjetla / Color temperature
4000 K

Indeks uzvrata boje / CRI
RA >80

Kom./kutija / Pcs/ctn
10



šifra / art. no. (EAN 3856024403429)	snaga / power	svjetlosni tok svjetiljke / luminaire luminous flux	svjetlosni tok izvora svjetlosti / light source luminous flux	promjer svjetiljke / lamp diameter
407-125 (EAN 3856024403429)	12 W	840 lm	1200 lm	260 mm
407-126 (EAN 3856024403436)	18 W	1260 lm	1850 lm	330 mm
407-127 (EAN 3856024403443)	24 W	1680 lm	2500 lm	380 mm
407-128 (EAN 3856024403450)	30 W	2240 lm	3150 lm	380 mm

Nazivni napon / Input voltage
220-240 V~ 50/60 Hz

Životni vijek / Lifespan
30.000 h

Stupanj zaštite / IP grade
IP54

Temperatura svjetla / Color temperature
4000 K

Indeks uzvrata boje / CRI
RA >80

Kom./kutija / Pcs/ctn
10

Nazivni napon / Input voltage
165-265 V~ 50/60 Hz

Životni vijek / Lifespan
25.000 h

Indeks uzvrata boje / CRI
RA >80

Stupanj zaštite / IP grade
IP54

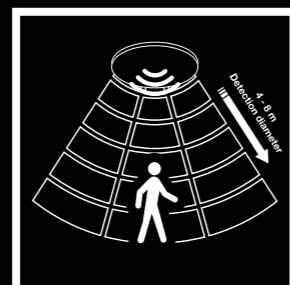

Mikrovalni detektor pokreta
Šifra 407-201, 407-202, 407-203
Mogućnost podešavanja postavki senzora
Microwave motion detector
Art.No. 407-201, 407-202, 407-203
Adjustable sensor settings

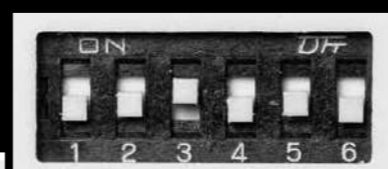

Temperatura svjetla / Color temperature
3000/4000/6500 K

COLOUR TEMPERATURE SWITCH

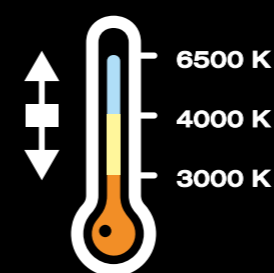

šifra / art. no.	snaga / power	svjetlosni tok svjetiljke / luminaire luminous flux	svjetlosni tok izvora svjetlosti / light source luminous flux	detektor pokreta / motion detector	promjer svjetiljke / lamp diameter
407-101 (EAN 3858890444636)	15 W	1500 lm	2000 lm	-	220 mm
407-102 (EAN 3858890444643)	18 W	1850 lm	2550 lm	-	280 mm
407-103 (EAN 3858890444650)	24 W	2500 lm	3200 lm	-	330 mm
407-201 (EAN 3858890448979)	15 W	1500 lm	2000 lm	4 - 8 m	220 mm
407-202 (EAN 3858890448986)	18 W	1850 lm	2550 lm	4 - 8 m	280 mm
407-203 (EAN 3858890448993)	24 W	2500 lm	3200 lm	4 - 8 m	330 mm

Značajke

Features

Vodootporna kutija za ožičenje se nalazi s vanjske strane kućišta pa nema potrebe za otvaranjem svjetiljke prilikom montaže

The waterproof wiring box is located on the outer side of housing so there is no need for disassembling the lamp housing when mounting

Stezaljke za prihvat kabela bez vijaka omogućavaju jednostavnu i brzu montažu

Screwless cable clamps allow easy and quick mounting

šifra / art. no.	snaga / power	svjetlosni tok svjetiljke / luminaire luminous flux	svjetlosni tok izvora svjetlosti / light source luminous flux	promjer svjetiljke / lamp diameter	kom./kutija / pcs/ctn
407-105 (EAN 3856024402651)	18 W	1800 lm	1880 lm	220 mm	20
407-106 (EAN 3856024402668)	24 W	2400 lm	2565 lm	280 mm	10
407-107 (EAN 3856024402675)	30 W	3000 lm	3255 lm	330 mm	10

Značajke

Features

Sa sklopkom za odabir temperature svjetla

With CCT switch for color temperature adjustment



LED PANELI LED PANELS

Nazivni napon / Input voltage

220-240 V~ 50/60 Hz

Životni vijek / Lifespan

25.000 h

Indeks uzvrata boje / CRI

RA >80

Kom./kutija / Pcs/ctn

10



Značajke Features
Integrirani driver Integrated driver



šifra / art. no.	snaga / power	svjetlosni tok svjetiljke / luminaire luminous flux	svjetlosni tok izvora svjetlosti / light source luminous flux	temperatura svjetla / color temperature	promjer svjetiljke / lamp diameter	promjer otvora za montažu / cutout diameter
337-351 (EAN 3856024402088)	3 W	240 lm	260 lm	3000 K	90 mm	75 mm
337-352 (EAN 3856024402095)	3 W	240 lm	260 lm	4000 K	90 mm	75 mm
337-372 (EAN 3856024402118)	12 W	960 lm	1200 lm	4000 K	170 mm	158 mm



Značajke
Integrirani driver

Brza montaža LED panela na nosač - "klik" sistem, bez upotrebe odvijača

Features
Integrated driver

Quick and easy mounting of LED panel - "click" system, without the use of a screwdriver



šifra / art. no.	snaga / power	svjetlosni tok svjetiljke / luminaire luminous flux	svjetlosni tok izvora svjetlosti / light source luminous flux	temperatura svjetla / color temperature	promjer svjetiljke / lamp diameter
337-366 (EAN 3856024402132)	6 W	480 lm	520 lm	4000 K	120 mm
337-376 (EAN 3856024402149)	12 W	960 lm	1200 lm	4000 K	170 mm



Nazivni napon / Input voltage
220-240 V~ 50/60 Hz

Životni vijek / Lifespan
25.000 h

Indeks uzvrata boje / CRI
RA >80

Temperatura svjetla / Color temperature
2700/4000/6500 K



**COLOUR
TEMPERATURE
SWITCH**

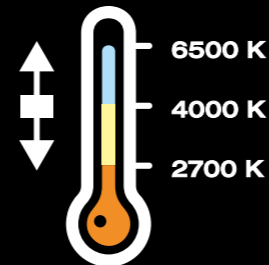

Nazivni napon / Input voltage
220-240 V~ 50/60 Hz

Životni vijek / Lifespan
25.000 h

Indeks uzvrata boje / CRI
RA >80

Temperatura svjetla / Color temperature
2700/4000/6500 K



**COLOUR
TEMPERATURE
SWITCH**

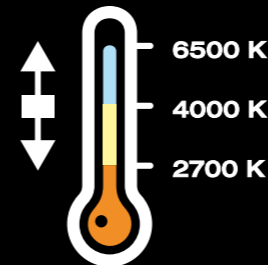

šifra / art. no.

snaga /
power

svjetlosni tok
svjetiljke /
luminaire
luminous flux

svjetlosni tok
izvora svjetlosti
/ light source
luminous flux

promjer svjetiljke /
lamp diameter

promjer otvora
za montažu /
cutout diameter

kom./kutija /
pcs/ctn

337-304 (EAN 3856024402323)	6 W	400 lm	525 lm	115 mm	105 mm	50
337-314 (EAN 3856024402330)	12 W	900 lm	1190 lm	170 mm	155 mm	40
337-324 (EAN 3856024402347)	18 W	1500 lm	1880 lm	220 mm	205 mm	20
337-334 (EAN 3856024402422)	24 W	1950 lm	2565 lm	240 mm	225 mm	20

Značajke
Integrirani driver

Features
Integrated driver



šifra / art. no.

snaga /
power

svjetlosni tok
svjetiljke /
luminaire
luminous flux

svjetlosni tok
izvora svjetlosti
/ light source
luminous flux

promjer svjetiljke /
lamp diameter

promjer otvora
za montažu /
cutout diameter

kom./kutija /
pcs/ctn

337-704 (EAN 3856024407427)	6 W	400 lm	525 lm	115 mm	105 mm	50
337-714 (EAN 3856024407434)	12 W	900 lm	1190 lm	170 mm	155 mm	40
337-724 (EAN 3856024407441)	18 W	1500 lm	1880 lm	220 mm	205 mm	20
337-734 (EAN 3856024407458)	24 W	1950 lm	2565 lm	240 mm	225 mm	20

Značajke
Integrirani driver

Features
Integrated driver



Nazivni napon / Input voltage
220-240 V~ 50/60 Hz

Životni vijek / Lifespan
25.000 h

Indeks uzvrata boje / CRI
RA >80

Temperatura svjetla / Color temperature
2700/4000/6500 K

**COLOUR
TEMPERATURE
SWITCH**

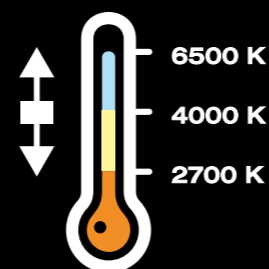

Nazivni napon / Input voltage
220-240 V~ 50/60 Hz

Životni vijek / Lifespan
25.000 h

Indeks uzvrata boje / CRI
RA >80

Temperatura svjetla / Color temperature
2700/4000/6500 K

**COLOUR
TEMPERATURE
SWITCH**

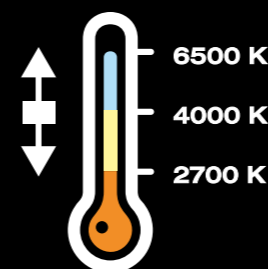

šifra / art. no.	snaga / power	svjetlosni tok svjetiljke / luminaire luminous flux	svjetlosni tok izvora svjetlosti / light source luminous flux	promjer svjetiljke / lamp diameter	faktor snage / power factor	kom./kutija / pcs/ctn
337-308 (EAN 3856024402361)	6 W	400 lm	525 lm	122 mm	>0.9	50
337-318 (EAN 3856024402378)	12 W	900 lm	1190 lm	177 mm	>0.9	40
337-328 (EAN 3856024402385)	18 W	1500 lm	1880 lm	226 mm	>0.9	20
337-338 (EAN 3856024402392)	24 W	1950 lm	2565 lm	245 mm	>0.9	20

Značajke
Integrirani driver

Brza montaža LED panela na nosač - "klik" sistem, bez upotrebe odvijača

Features
Integrated driver

Quick and easy mounting of LED panel - "click" system, without the use of a screwdriver

šifra / art. no.	snaga / power	svjetlosni tok svjetiljke / luminaire luminous flux	svjetlosni tok izvora svjetlosti / light source luminous flux	promjer svjetiljke / lamp diameter	faktor snage / power factor	kom./kutija / pcs/ctn
337-708 (EAN 3856024407465)	6 W	400 lm	525 lm	122 mm	>0.9	50
337-718 (EAN 3856024407472)	12 W	900 lm	1190 lm	177 mm	>0.9	40
337-728 (EAN 3856024407489)	18 W	1500 lm	1880 lm	226 mm	>0.9	20
337-738 (EAN 3856024407496)	24 W	1950 lm	2565 lm	245 mm	>0.9	20

Značajke
Integrirani driver

Brza montaža LED panela na nosač - "klik" sistem, bez upotrebe odvijača

Features
Integrated driver

Quick and easy mounting of LED panel - "click" system, without the use of a screwdriver

Nazivni napon / Input voltage
220-240 V~ 50/60 Hz

Životni vijek / Lifespan
25.000 h

Indeks uzvrata boje / CRI
RA >80

Temperatura svjetla / Color temperature
2700/4000/6500 K

Nazivni napon / Input voltage
220-240 V~ 50/60 Hz

Životni vijek / Lifespan
25.000 h

Indeks uzvrata boje / CRI
RA >80

Temperatura svjetla / Color temperature
2700/4000/6500 K

**COLOUR
TEMPERATURE
SWITCH**

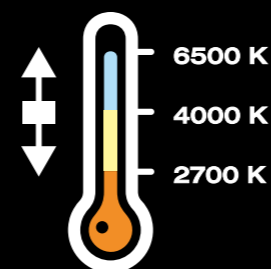

**COLOUR
TEMPERATURE
SWITCH**

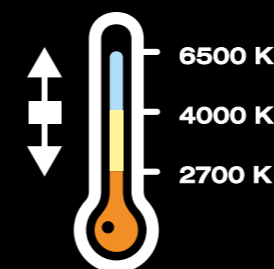

šifra / art. no.	snaga / power	svjetlosni tok svjetiljke / luminaire luminous flux	svjetlosni tok izvora svjetlosti / light source luminous flux	dimenzije svjetiljke / lamp dimenzije	dimenzije otvora za montažu / cutout dimensions	kom./kutija / pcs/ctn
337-404 (EAN 3856024402439)	6 W	400 lm	525 lm	120 x 120 mm	105 x 105 mm	50
337-414 (EAN 3856024402446)	12 W	900 lm	1190 lm	170 x 170 mm	155 x 155 mm	40
337-424 (EAN 3856024402354)	18 W	1500 lm	1880 lm	220 x 220 mm	205 x 205 mm	20
337-434 (EAN 3856024402453)	24 W	1950 lm	2565 lm	220 x 220 mm	205 x 205 mm	20

Značajke
Integrirani driver

Features
Integrated driver

šifra / art. no.	snaga / power	svjetlosni tok svjetiljke / luminaire luminous flux	svjetlosni tok izvora svjetlosti / light source luminous flux	dimenzije svjetiljke / lamp dimenzije	faktor snage / power factor	kom./kutija / pcs/ctn
337-408 (EAN 3856024402460)	6 W	400 lm	525 lm	122 x 122 mm	>0.9	50
337-418 (EAN 3856024402477)	12 W	900 lm	1190 lm	172 x 172 mm	>0.9	40
337-428 (EAN 3856024402408)	18 W	1500 lm	1880 lm	227 x 227 mm	>0.9	20
337-438 (EAN 3856024402415)	24 W	1950 lm	2565 lm	227 x 227 mm	>0.9	20

Značajke
Integrirani driver

Features
Integrated driver

Brza montaža LED panela na nosač - "klik" sistem, bez upotrebe odvijača

Quick and easy mounting of LED panel - "click" system, without the use of a screwdriver



Nazivni napon / Input voltage
220-240 V~ 50 Hz

Životni vijek / Lifespan
30.000 h

Indeks uzvrata boje / CRI
RA >80

Kom./kutija / Pcs/ctn
5

Nazivni napon / Input voltage
220-240 V~ 50 Hz

Životni vijek / Lifespan
30.000 h

Indeks uzvrata boje / CRI
RA >80

Kom./kutija / Pcs/ctn
5



šifra / art. no.	snaga / power	svjetlosni tok svjetiljke / luminaire luminous flux	svjetlosni tok izvora svjetlosti / light source luminous flux	temperatura svjetla / color temperature	dimenzije svjetiljke / lamp dimenzije
337-602 (EAN 3856024404631)	45 W	4500 lm	5400 lm	4000 K	595 x 595 x 35 mm

šifra / art. no.	snaga / power	svjetlosni tok svjetiljke / luminaire luminous flux	svjetlosni tok izvora svjetlosti / light source luminous flux	temperatura svjetla / color temperature	dimenzije svjetiljke / lamp dimenzije
337-506 (EAN 38586024406239)	45 W	4500 lm	5400 lm	4000 K	595 x 595 x 10 mm
337-507 (EAN 38586024406246)	45 W	4500 lm	5400 lm	6500 K	595 x 595 x 10 mm

Značajke
Nadgradna i ugradna montaža

Features
Surface and recessed installation



Životni vijek / Lifespan
30.000 h

Indeks uzvrata boje / CRI
RA >80

Kom./kutija / Pcs/ctn
5



1



šifra / art. no.	snaga / power	svjetlosni tok svjetiljke / luminaire luminous flux	temperatura svjetla / color temperature	dimenzije svjetiljke / lamp dimenzije	nazivni napon / input voltage
337-505 (EAN 3858890447583)	40 W	3200 lm	4000 K	595 x 595 x 10 mm	180-265 V~ 50/60 Hz
337-503 (EAN 3858890449358)	45 W	4500 lm	4000 K	595 x 595 x 10 mm	220-240 V~ 50/60 Hz
337-504 (EAN 3858890449365)	45 W	4500 lm	6500 K	595 x 595 x 10 mm	220-240 V~ 50/60 Hz
337-515 (EAN 3858890449372)	40 W	3200 lm	4000 K	1195 x 295 x 10 mm	220-240 V~ 50/60 Hz

slika / photo	šifra / art. no.	opis / description	dimenzije svjetiljke / lamp dimensions	kom./kutija / pcs/ctn
1	337-901 (EAN 3858890443417)	set za nadgradnu montažu LED panela 595x595 mm / surface mount kit for LED panel 595x595 mm	600 x 600 x 50 mm	20
1	337-903 (EAN 3858890444094)	set za nadgradnu montažu LED panela 1195x295 mm / surface mount kit for LED panel 1195x295 mm	1200 x 300 x 50 mm	20
2	337-902 (EAN 3858890443905)	nosači s oprugom za montažu LED panela (pakiranje 4 komada) / spring clips for LED panel (4 pcs)	-	1

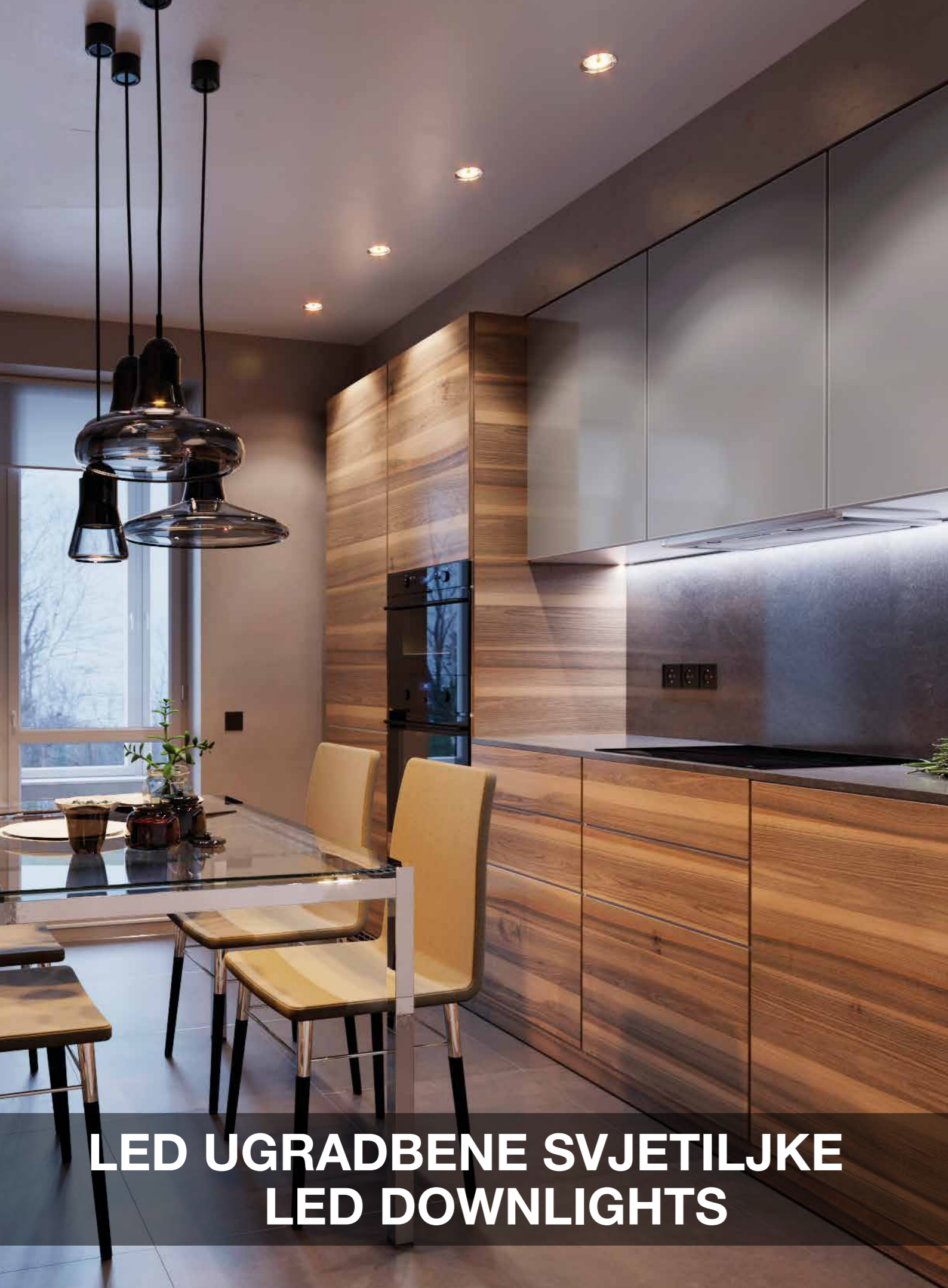

LED UGRADBENE SVJETILJKE LED DOWNLIGHTS

Nazivni napon / Input voltage
220-240 V~ 50/60 Hz

Životni vijek / Lifespan
25.000 h

Indeks uzvrata boje / CRI
RA >80

Kom./pak / Pcs./pkg
3

Kom./kutija / Pcs/ctn
20

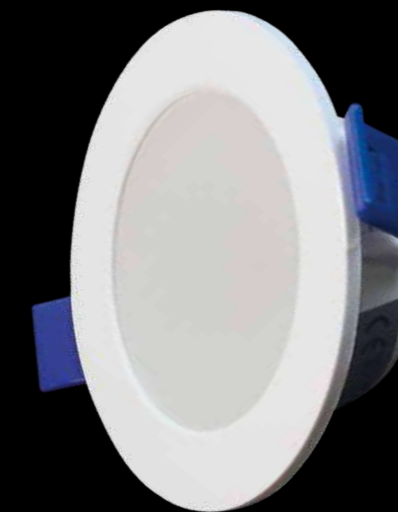

Pakiranje sadrži set od 3 svjetiljke
3-pack set of downlights

šifra / art. no.	snaga / power	svjetlosni tok svjetiljke / luminaire luminous flux	temperatura svjetla / color temperature	kut snopa svjetlosti / beam angle	promjer svjetiljke / lamp diameter	promjer otvora za montažu / cutout diameter	
336-123 (EAN 3856024406642)	3 W	270 lm	3000 K	120°	90 mm	70-80 mm	
336-124 (EAN 3856024406659)	3 W	270 lm	4000 K	120°	90 mm	70-80 mm	

Nazivni napon / Input voltage
220-240 V~ 50/60 Hz

Životni vijek / Lifespan
25.000 h

Indeks uzvrata boje / CRI
RA >80

Kom./pak / Pcs./pkg
3

Kom./kutija / Pcs/ctn
20



Pakiranje sadrži set od 3 svjetiljke
3-pack set of downlights

šifra / art. no.	snaga / power	svjetlosni tok svjetiljke / luminaire luminous flux	temperatura svjetla / color temperature	kut snopa svjetlosti / beam angle	promjer svjetiljke / lamp diameter	promjer otvora za montažu / cutout diameter	
336-126 (EAN 3856024406666)	5 W	370 lm	3000 K	38°	90 mm	70-80 mm	
336-127 (EAN 3856024406673)	5 W	370 lm	4000 K	38°	90 mm	70-80 mm	



LED CIJEVI LED TUBES



Napajanje s jedne strane; Montaža u svjetiljke bez prigušnice i startera
Single end input; Mounting in lamps without ballast or starter

Nazivni napon / Input voltage
220-240 V~ 50 Hz

Životni vijek / Lifespan
30.000 h

Indeks uzvrata boje / CRI
RA >80

Kom./kutija / Pcs/ctn
25

šifra / art. no.	snaga / power	tip / type	svjetlosni tok svjetiljke / luminaire luminous flux	temperatura svjetla / color temperature	
305-607 (EAN 3856024404570)	9 W	T8 60 cm	990 lm	4000 K	
305-617 (EAN 3856024404587)	9 W	T8 60 cm	990 lm	6500 K	
305-608 (EAN 3856024404594)	18 W	T8 120 cm	1980 lm	4000 K	
305-618 (EAN 3856024404600)	18 W	T8 120 cm	1980 lm	6500 K	
305-609 (EAN 3856024404617)	24 W	T8 150 cm	2640 lm	4000 K	
305-619 (EAN 3856024404624)	24 W	T8 150 cm	2640 lm	6500 K	

Značajke
Nano PC - LED cijevi s difuzorom od nano polikarbonata imaju mnogo prednosti u odnosu na LED cijevi sa staklenim ili plastičnim difuzorom. Nano polikarbonat omogućuje odličnu provodljivost i bolje raspršivanje svjetlosti te otpornost na mehanička oštećenja

Features
Nano PC - LED tubes with nano polycarbonate diffuser have many advantages over LED tubes with glass or plastic diffuser. Nano polycarbonate provides excellent transmittance and higher dispersion of light, and also high resistance to mechanical damage

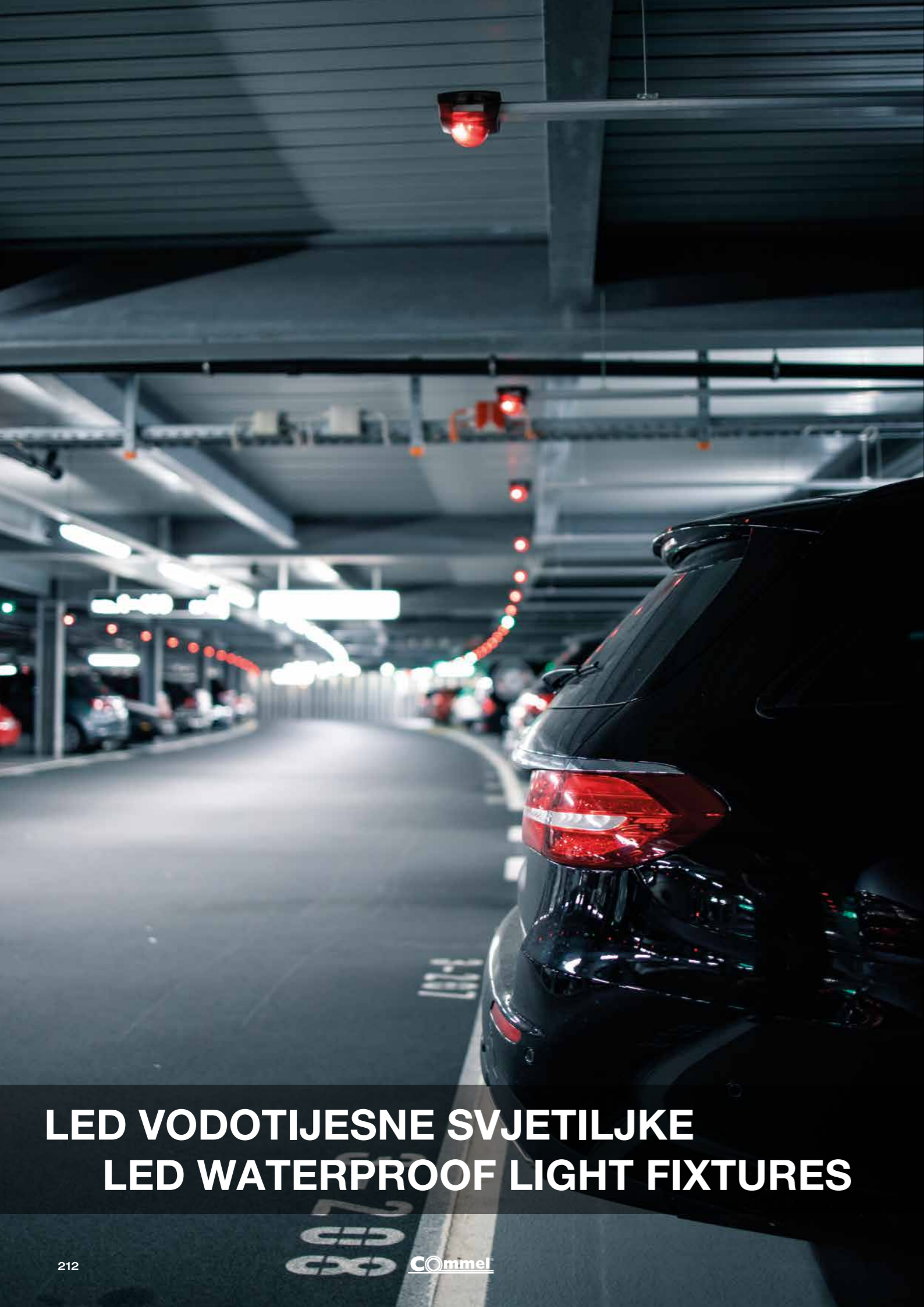

Nazivni napon / Input voltage
220-240 V~ 50/60 Hz

Temperatura svjetla / Color temperature
4000 K

Životni vijek / Lifespan
50.000 h

Stupanj zaštite / IP grade
IP65

Indeks uzvrata boje / CRI
RA >80

Materijal kućišta / Housing material
PC

Kom./kutija / Pcs/ctn
12

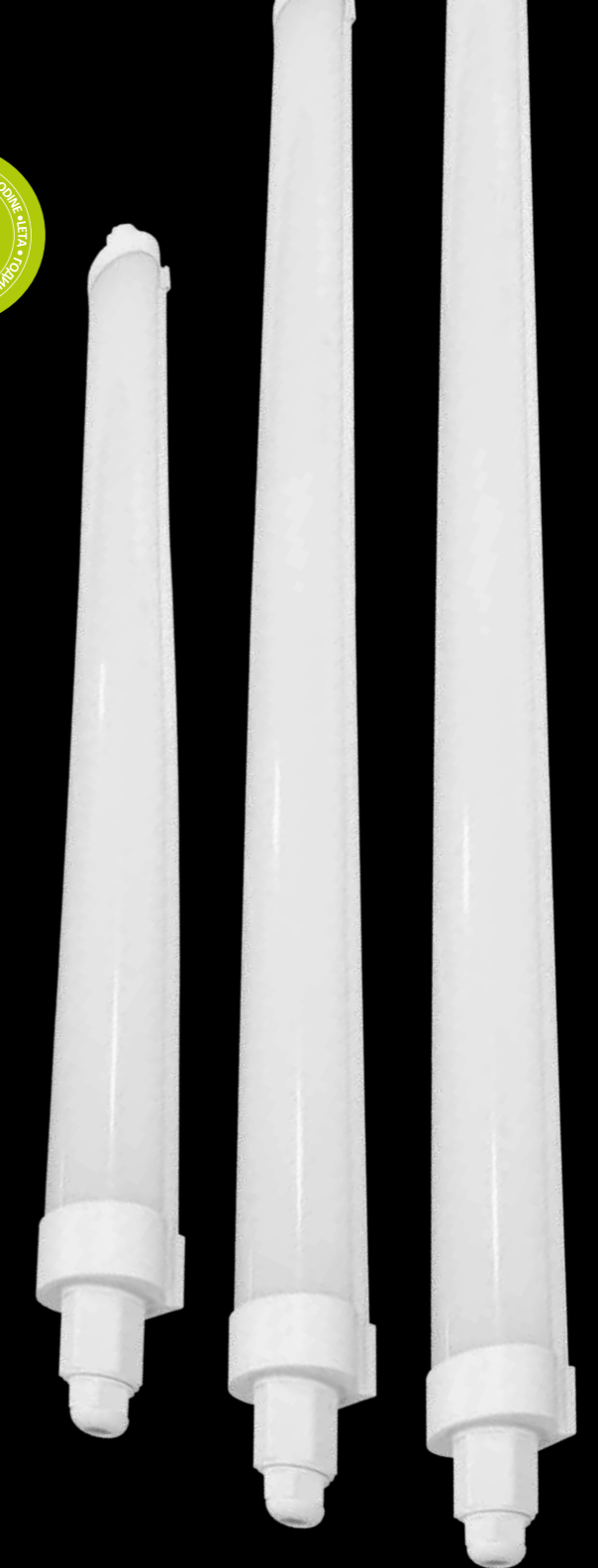

šifra / art. no.	snaga / power	svjetlosni tok svjetiljke / luminaire luminous flux	svjetlosni tok izvora svjetlosti / light source luminous flux	dimenzije / dimensions
344-683 (EAN 3856024406345)	18 W	2350 lm	2520 lm	600 x 69 x 49 mm
344-681 (EAN 3856024406338)	36 W	4700 lm	5040 lm	1280 x 69 x 49 mm
344-686 (EAN 3856024406352)	50 W	6500 lm	7000 lm	1500 x 69 x 49 mm

Značajke	Features
IP65 brzi konektor za spajanja kabela	IP65 quick cable connector
Mogućnost serijskog spajanja	Possibility of serial connection

LED VODOTIJESNE SVJETILJKE LED WATERPROOF LIGHT FIXTURES



Nazivni napon / Input voltage
220-240 V~ 50/60 Hz

Životni vijek / Lifespan
25.000 h

Stupanj zaštite / IP grade
IP65

Indeks uzvrata boje / CRI
RA >80

Materijal kućišta / Housing material
ABS+PC

Kom./kutija / Pcs/ctn
8

Nazivni napon / Input voltage
220-240 V~ 50/60 Hz

Temperatura svjetla / Color temperature
4000 K

Životni vijek / Lifespan
30.000 h

Stupanj zaštite / IP grade
IP65

Indeks uzvrata boje / CRI
RA >80

Materijal kućišta / Housing material
PC



šifra / art. no.	snaga / power	svjetlosni tok svjetiljke / luminaire luminous flux	temperatura svjetla / color temperature	dimenzije / dimensions
344-607 (EAN 3856024402071)	2 x 10 W	2 x 1000 lm	4000 K	660 x 80 x 96 mm
344-617 (EAN 3856024402040)	2 x 10 W	2 x 1000 lm	6500 K	660 x 80 x 96 mm
344-608 (EAN 3856024402026)	2 x 18 W	2 x 1900 lm	4000 K	1260 x 80 x 96 mm
344-618 (EAN 3856024402057)	2 x 18 W	2 x 1900 lm	6500 K	1260 x 80 x 96 mm
344-609 (EAN 3856024402033)	2 x 24 W	2 x 2550 lm	4000 K	1560 x 80 x 96 mm
344-619 (EAN 3856024402064)	2 x 24 W	2 x 2550 lm	6500 K	1560 x 80 x 96 mm

šifra / art. no.	snaga / power	svjetlosni tok svjetiljke / luminaire luminous flux	svjetlosni tok izvora svjetlosti / light source luminous flux	dimenzije / dimensions	kom./kutija / pcs/ctn
344-663 (EAN 3856024402606)	21 W	2520 lm	3000 lm	590 x 72 x 61 mm	15
344-661 (EAN 3856024402590)	40 W	4800 lm	5600 lm	1180 x 72 x 61 mm	12
344-666 (EAN 3856024402613)	55 W	6600 lm	7400 lm	1480 x 72 x 61 mm	9

Značajke / Features
Mogućnost serijskog spajanja / Possibility of serial connection



PANIK LED SVJETILJKE EMERGENCY LED LIGHT FIXTURES

Nazivni napon / Input voltage
220-240 V~ 50/60 Hz

Stupanj zaštite / IP grade
IP65

Autonomija rada /
Working autonomy
3 h

346-204



Li-FePO4 18650
3.2 V 1000 mAh



346-205

šifra / art. no.	snaga / power	svjetlosni tok / luminous flux	temperatura svjetla / color temperature	dimenzije / dimensions	kom./kutija / pcs/ctn
346-204 (EAN 3856024406710)	2.5 W	170 lm	6500 K	352 x 110 x 64 mm	12
346-205 (EAN 3856024406727)	2.5 W	170 lm	6600 K	254 x 93 x 56 mm	20

Nazivni napon / Input voltage
220-240 V~ 50 Hz

Stupanj zaštite / IP grade
IP20



Stropna instalacija
Ceiling installation



Zidna instalacija
Wall installation



šifra / art. no.	snaga / power	autonomija rada / working autonomy	baterija / battery	dimenzije / dimensions	kom./kutija / pcs/ctn
346-203 (EAN 3856024403856)	2.2 W	3 h	Ni-Cd 3.6 V 800 mAh	345 x 215 x 40 mm	6



LED HIGHBAY LED HIGHBAY

Nazivni napon / Input voltage
100-240 V~ 50/60 Hz

Temperatura svjetla / Color temperature
4000 K

Životni vijek / Lifespan
54.000 h

Stupanj zaštite / IP grade
IP65

Kut svjetlosti / Beam angle
90°

kom./kutija / pcs/ctn
1



šifra / art. no. (EAN 3856024406970)	snaga / power	svjetlosni tok svjetiljke / luminaire luminous flux	dimenzije / dimensions	
325-111	100 W	12 000 lm	Ø 250 x 143 mm	
325-112	150 W	18 000 lm	Ø 310 x 144 mm	
325-113	200 W	24 000 lm	Ø 360 x 144 mm	



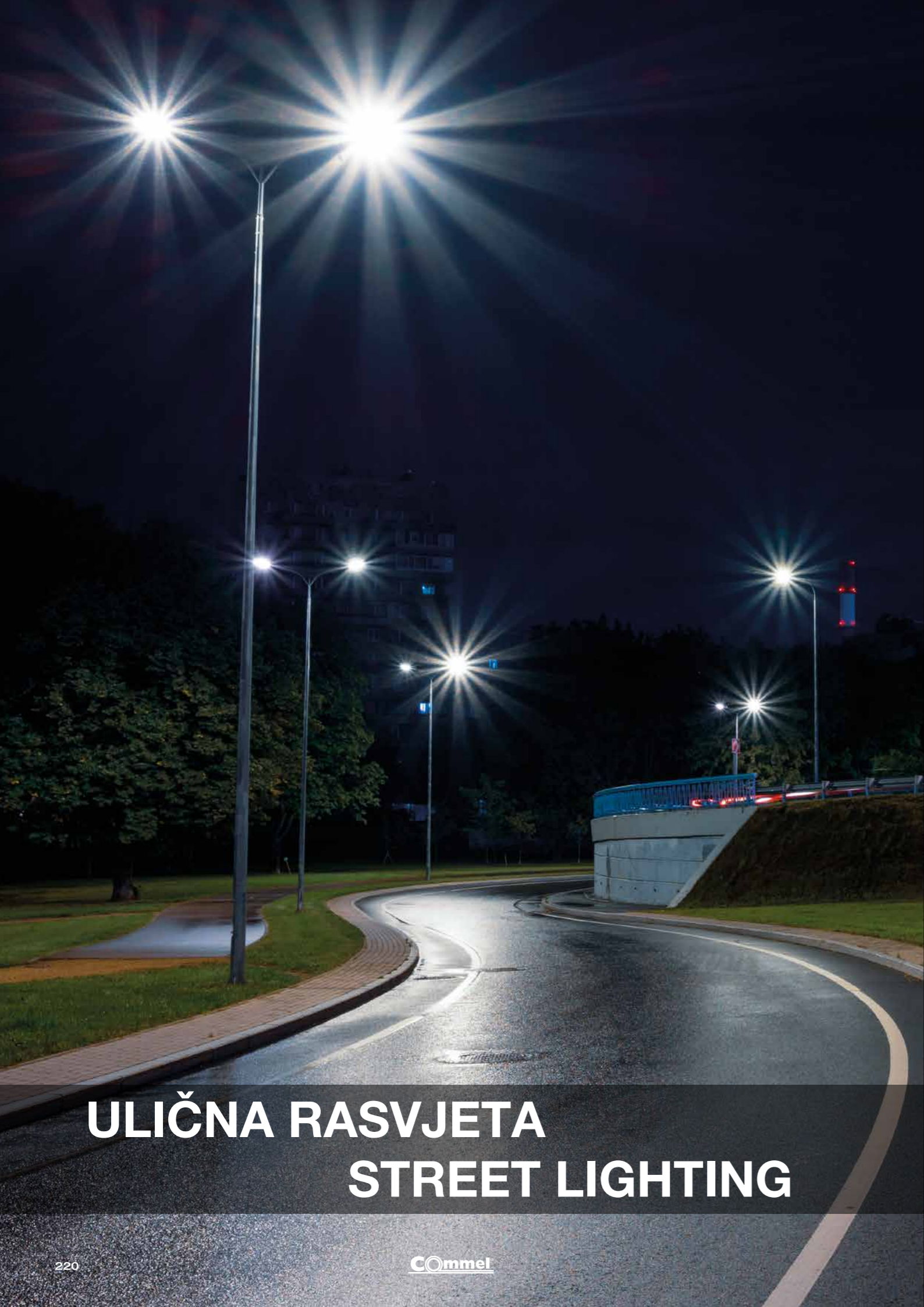

ULIČNA RASVJETA STREET LIGHTING

Nazivni napon / Input voltage
220-240 V~ 50/60 Hz

Temperatura svjetla / Color temperature
4000 K

Životni vijek / Lifespan
36.000 h

Stupanj zaštite / IP grade
IP65

Promjer nosača za montažu /
Mounting bracket diameter
60 mm

Stupanj zaštite / IK grade
IK08

Radna temperatura / Working temperature
-40°C +50°C

Kut svjetlosti / Beam angle
130°

Indeks uzvrata boje / CRI
RA >70



šifra / art. no. (EAN)	snaga / power	svjetlosni tok svjetiljke / luminaire luminous flux	dimenzije / dimensions	kom./kutija / pcs/ctn	
326-101 (EAN 3856024408189)	50 W	5 200 lm	430 x 145 x 90 mm	10	
326-102 (EAN 3856024408196)	100 W	10 500 lm	480 x 155 x 90 mm	5	
326-103 (EAN 3856024408202)	150 W	15 700 lm	535 x 165 x 90 mm	5	

NOSAČ ULIČNE RASVJETE / STREET LIGHT BRACKET

šifra / art. no. (EAN)	dimenzije / dimensions	kom./kutija / pcs/ctn
326-951 (EAN 3856024408219)	170 x 185 x 100 mm	10
326-952 (EAN 3856024408226)	430 x 220 x 140 mm	10
326-953 (EAN 3856024408233)	135 x 140 x 95 mm	15

Ø 60 mm

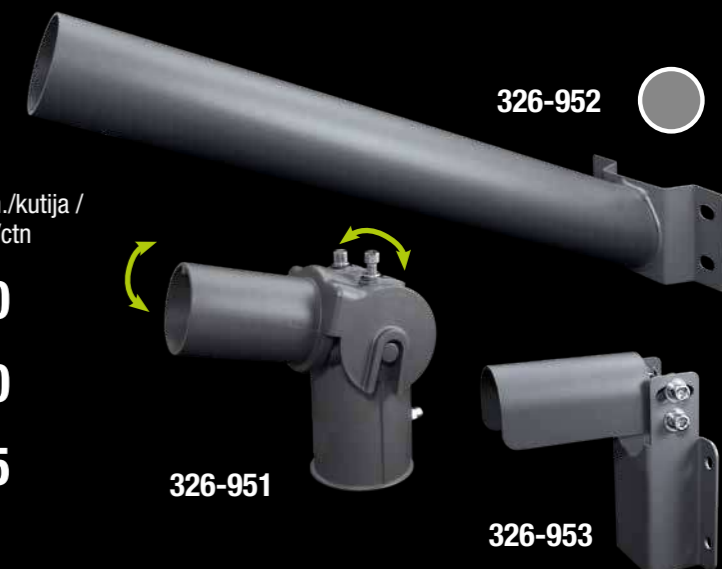

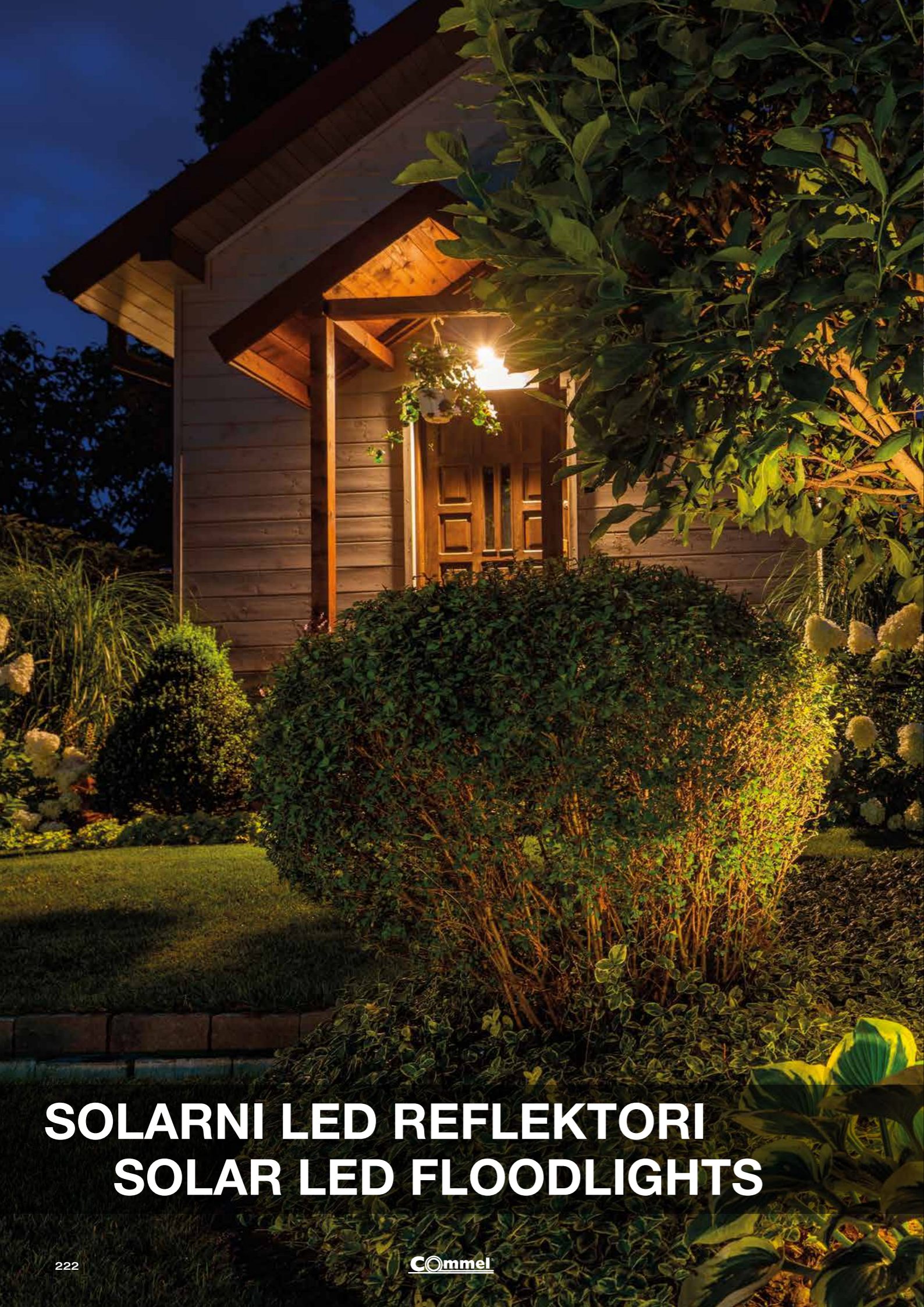

SOLARNI LED REFLEKTORI SOLAR LED FLOODLIGHTS



Temperatura svjetla / Color temperature
4000 K

Stupanj zaštite / IP grade
IP54

Kom./kutija / Pcs/ctn
12

2 načina montaže / 2 mounting ways

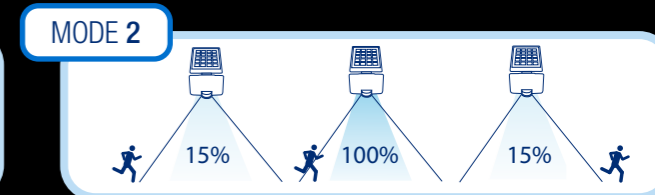
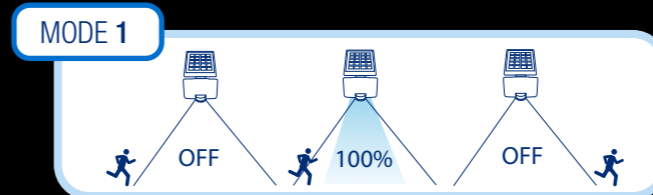

2 načina rada / 2 working modes

šifra / art. no.
309-101
(EAN 3856024403580)

snaga / power
8 W

svjetlosni tok /
luminous flux
800 lm

baterija / battery
18650 3.7V 2000mAh

dimenzije / dimensions
290 x 178 x 140 mm

šifra / art. no.
309-102
(EAN 3856024403597)

snaga / power
11 W

svjetlosni tok /
luminous flux
1500 lm

baterija / battery
18650 3.7V 4000mAh

dimenzije / dimensions
290 x 178 x 140 mm



Temperatura svjetla prednje i pozadinsko /
Color temperature front and back light

4000 K + 3000 K

Stupanj zaštite / IP grade

IP44

Kom./kutija / Pcs/ctn

24

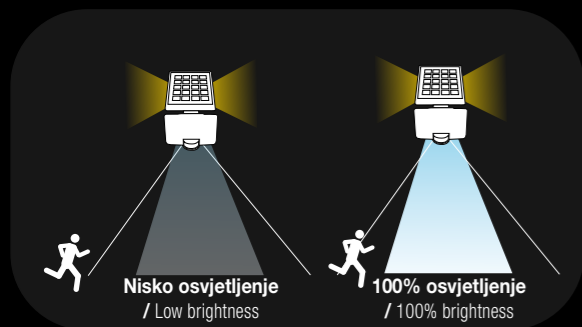

Temperatura svjetla prednje i pozadinsko /
Color temperature front and back light

4000 K + 3000 K

Stupanj zaštite / IP grade

IP44

Kom./kutija / Pcs/ctn

20

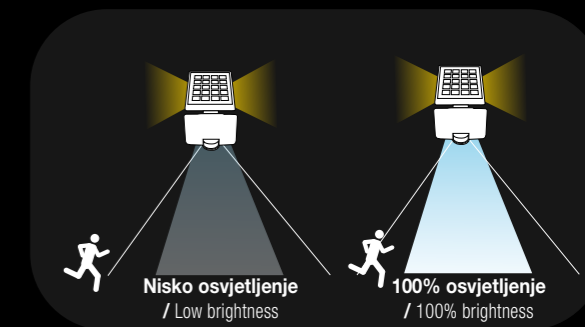
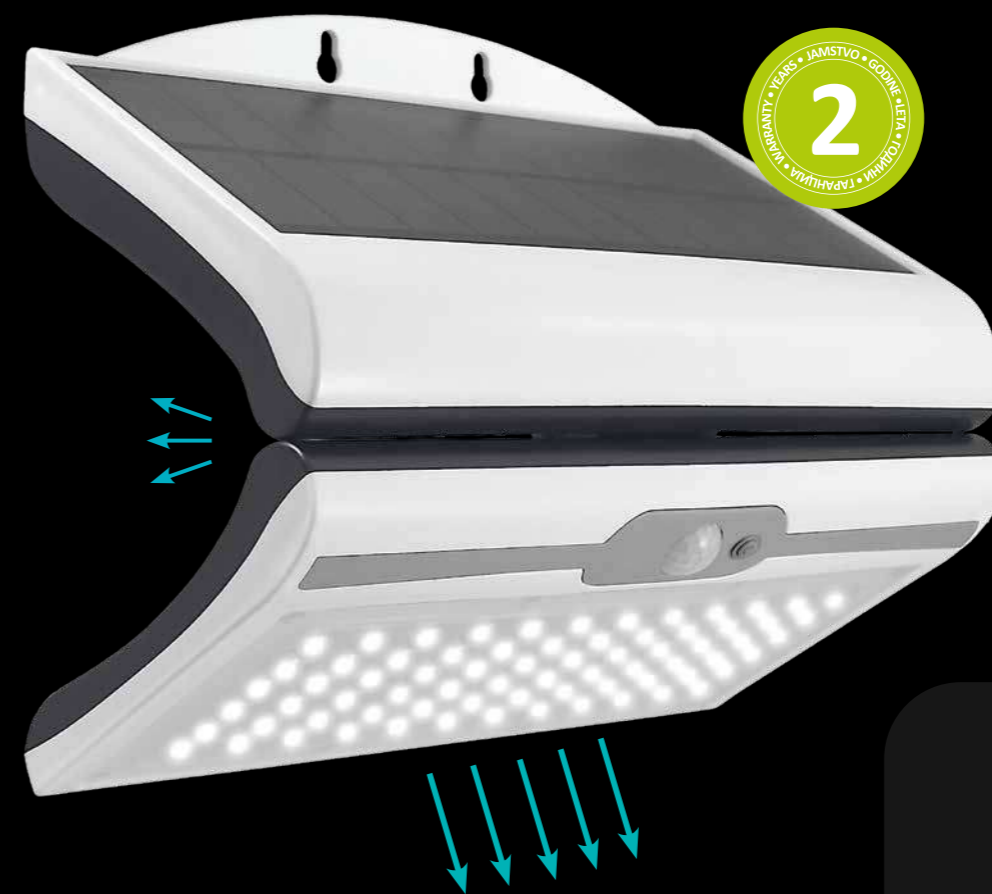

šifra / art. no.

309-103
(EAN 3856024406024)

snaga / power

3 W

svjetlosni tok /
luminous flux

200 lm

baterija / battery

18650 3.7V 1200mAh

dimenzije / dimensions

155 x 95 x 80 mm

šifra / art. no.

309-104
(EAN 3856024406031)

snaga / power

4,5 W

svjetlosni tok /
luminous flux

430 lm

baterija / battery

18650 3.7V 3000mAh

dimenzije / dimensions

190 x 230 x 101 mm



LED REFLEKTORI LED FLOODLIGHTS

Nazivni napon / Input voltage
220-240 V~ 50/60 Hz

Životni vijek / Lifespan
30.000 h

Kut snopa svjetlosti / Beam angle
120°

Temperatura svjetla / Color temperature
4000 K



DETEKTOR POKRETA - podešavanje vremena, osjetljivosti i razine ambijentalnog osvjetljenja
MOTION DETECTOR - Adjustment of time, sensitivity and ambient light level



šifra / art. no.	snaga / power	detektori pokreta / motion detector	svjetlosni tok / luminous flux	stupanj zaštite / IP grade	kom./kutija / pcs/ctn	
306-119 (EAN 3856024402729)	10 W	-	800 lm	IP65	60	
306-129 (EAN 3856024402743)	20 W	-	1600 lm	IP65	40	
306-139 (EAN 3856024402767)	30 W	-	2550 lm	IP65	30	
306-159 (EAN 3856024402781)	50 W	-	4250 lm	IP65	20	
306-199 (EAN 3856024402804)	100 W	-	8500 lm	IP65	10	
307-119 (EAN 3856024402828)	10 W	120°	800 lm	IP44	60	
307-129 (EAN 3856024402842)	20 W	120°	1600 lm	IP44	40	
307-139 (EAN 3856024402866)	30 W	120°	2550 lm	IP44	20	
307-159 (EAN 3856024402880)	50 W	120°	4250 lm	IP44	20	

Značajke

Visoka kvaliteta, elegantan dizajn i pristupačna cijena glavne su odlike ove linije.

Features

High quality, elegant design and affordable price are the main features of this line.



Nazivni napon / Input voltage
220-240 V~ 50/60 Hz

Životni vijek / Lifespan
30.000 h

Kut snopa svjetlosti
/ Beam angle
120°

Temperatura svjetla
/ Color temperature
4000 K

Nazivni napon / Input voltage
220-240 V~ 50/60 Hz

Životni vijek / Lifespan
30.000 h

Kut snopa svjetlosti
/ Beam angle
120°

Temperatura svjetla
/ Color temperature
6500 K



DETEKTOR POKRETA - podešavanje vremena, osjetljivosti i razine ambijentalnog osvjetljenja
MOTION DETECTOR - Adjustment of time, sensitivity and ambient light level



šifra / art. no.	snaga / power	detektori pokreta / motion detector	svjetlosni tok / luminous flux	stupanj zaštite / IP grade	kom./kutija / pcs/ctn
306-219 (EAN 3856024402736)	10 W	-	800 lm	IP65	60
306-229 (EAN 3856024402750)	20 W	-	1600 lm	IP65	40
306-239 (EAN 3856024402774)	30 W	-	2550 lm	IP65	30
306-259 (EAN 3856024402798)	50 W	-	4250 lm	IP65	20
306-299 (EAN 3856024402811)	100 W	-	8500 lm	IP65	10
307-219 (EAN 3856024402835)	10 W	120°	800 lm	IP44	60
307-229 (EAN 3856024402859)	20 W	120°	1600 lm	IP44	40
307-239 (EAN 3856024402873)	30 W	120°	2550 lm	IP44	20
307-259 (EAN 3856024402897)	50 W	120°	4250 lm	IP44	20

Značajke

Visoka kvaliteta, elegantan dizajn i pristupačna cijena glavne su odlike ove linije.

Features

High quality, elegant design and affordable price are the main features of this line.



šifra / art. no.	snaga / power	detektori pokreta / motion detector	svjetlosni tok / luminous flux	stupanj zaštite / IP grade	kom./kutija / pcs/ctn
306-301 (EAN 3856024407236)	10 W	-	800 lm	IP65	60
306-302 (EAN 3856024407243)	20 W	-	1600 lm	IP65	40
306-303 (EAN 3856024407250)	30 W	-	2550 lm	IP65	30
306-304 (EAN 3856024407267)	50 W	-	4250 lm	IP65	20
306-305 (EAN 3856024407274)	100 W	-	8500 lm	IP65	10
307-301 (EAN 3856024407304)	10 W	120°	800 lm	IP44	60
307-302 (EAN 3856024407311)	20 W	120°	1600 lm	IP44	40
307-303 (EAN 3856024407328)	30 W	120°	2550 lm	IP44	20
307-304 (EAN 3856024407335)	50 W	120°	4250 lm	IP44	20

Značajke

Visoka kvaliteta, elegantan dizajn i pristupačna cijena glavne su odlike ove linije.

Features

High quality, elegant design and affordable price are the main features of this line.

Nazivni napon / Input voltage
220-240 V~ 50/60 Hz

Temperatura svjetla / Color temperature
4000 K

Kut snopa svjetlosti / Beam angle
120°



Nazivni napon / Input voltage
220-240 V~ 50/60 Hz

Temperatura svjetla / Color temperature
6500 K

Kut snopa svjetlosti / Beam angle
120°

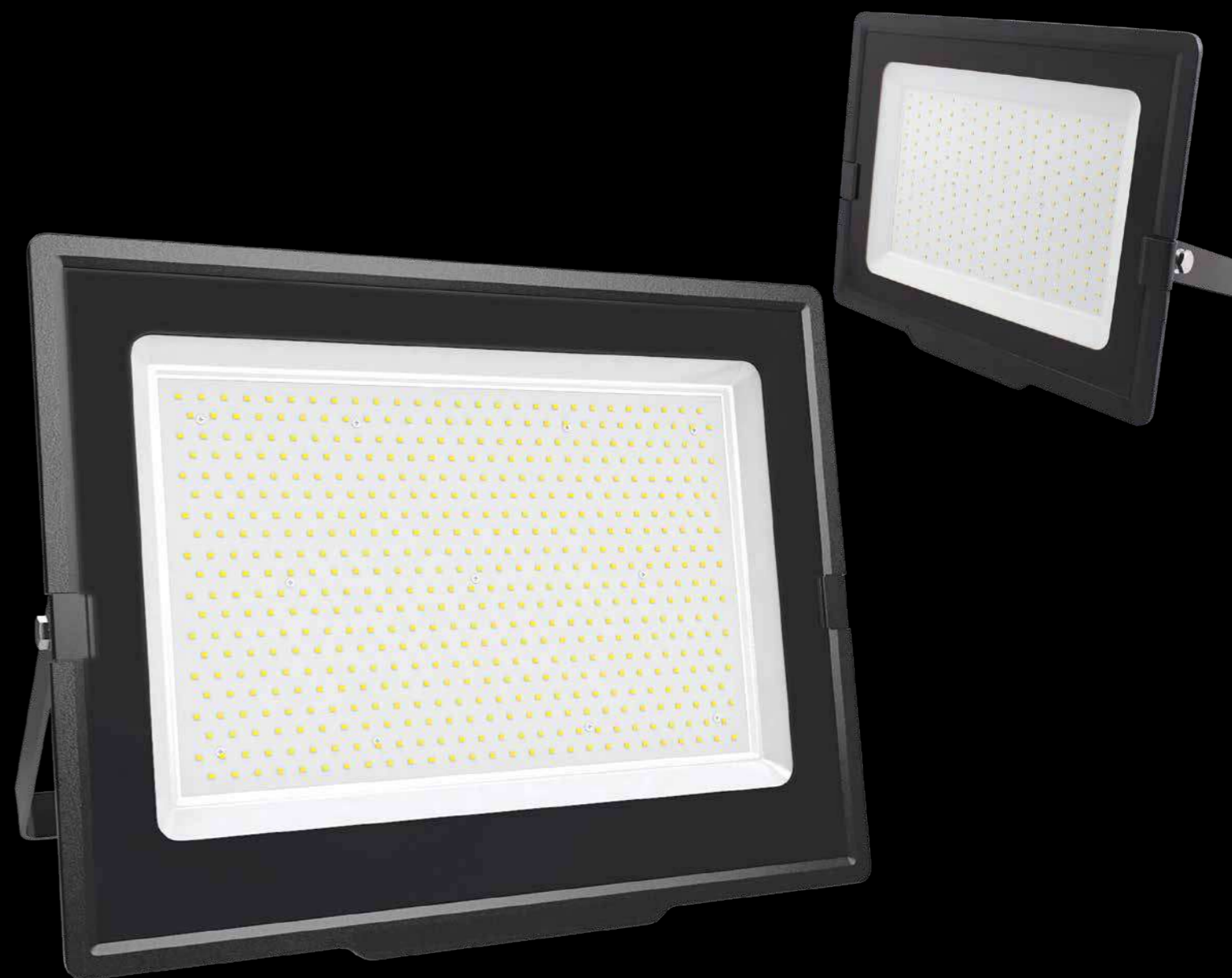

šifra / art. no.	snaga / power	svjetlosni tok / luminous flux	životni vijek / lifespan	stupanj zaštite / IP grade	kom./kutija / pcs/ctn	
306-201 (EAN 3856024404488)	150 W	13000 lm	30.000 h	IP65	5	
306-202 (EAN 3856024404495)	200 W	17000 lm	30.000 h	IP65	5	
306-203 (EAN 3856024407502)	300 W	25000 lm	36.000 h	IP65	4	
306-204 (EAN 3856024407519)	500 W	42300 lm	36.000 h	IP65	4	

Značajke

Visoka kvaliteta, elegantan dizajn i pristupačna cijena glavne su odlike ove linije.

Features

High quality, elegant design and affordable price are the main features of this line.



šifra / art. no.	snaga / power	svjetlosni tok / luminous flux	životni vijek / lifespan	stupanj zaštite / IP grade	kom./kutija / pcs/ctn	
306-306 (EAN 3856024407281)	150 W	13000 lm	30.000 h	IP65	5	
306-307 (EAN 3856024407298)	200 W	17000 lm	30.000 h	IP65	5	
306-308 (EAN 3856024407526)	300 W	25000 lm	36.000 h	IP65	4	
306-309 (EAN 3856024407533)	500 W	42300 lm	36.000 h	IP65	4	

Značajke

Visoka kvaliteta, elegantan dizajn i pristupačna cijena glavne su odlike ove linije.

Features

High quality, elegant design and affordable price are the main features of this line.

Temperatura svjetla / Color temperature

4000 K

Nazivni napon / Input voltage

220-240 V~ 50 Hz

Životni vijek / Lifespan

25.000 h

Kut snopa svjetlosti / Beam angle

120°



šifra / art. no.	snaga / power	svjetlosni tok / luminous flux	detektori pokreta / motion detector	stupanj zaštite / IP grade	dimenzije / dimensions	kom. / kutija / pcs/ctn
306-213 (EAN 3856024402934)	10 W	1 x 1000 lm	-	IP65	103 x 60 x 74 mm	60
306-223 (EAN 3856024402941)	20 W	1 x 2100 lm	-	IP65	122 x 60 x 97 mm	50
306-233 (EAN 3856024402958)	30 W	1 x 3200 lm	-	IP65	148 x 60 x 112 mm	30
306-253 (EAN 3856024402965)	50 W	1 x 5400 lm	-	IP65	196 x 62 x 146 mm	20
307-223 (EAN 3856024402972)	20 W	1 x 2100 lm	120°	IP44	124 x 73 x 180 mm	40
307-233 (EAN 3856024402989)	30 W	1 x 3200 lm	120°	IP44	148 x 73 x 200 mm	20
307-253 (EAN 3856024402996)	50 W	1 x 5400 lm	120°	IP44	198 x 73 x 234 mm	10

Značajke

Vodootporni konektor

Detektor pokreta s mogućnošću podešavanja načina rada

Features

Waterproof connector

Motion detector with adjustable settings

Temperatura svjetla / Color temperature

4000 K

Nazivni napon / Input voltage

220-240 V~ 50/60 Hz

Kut snopa svjetlosti / Beam angle

120°

Životni vijek / Lifespan

50.000 h



Premium Line



šifra / art. no.	snaga / power	svjetlosni tok / luminous flux	stupanj zaštite / IP grade	dimenzije / dimensions	kom./kutija / pcs/ctn
306-271 (EAN 3856024403504)	70 W	9450 lm	IP65	255 x 198 x 36 mm	10
306-272 (EAN 3856024403511)	100 W	13500 lm	IP65	315 x 233 x 38 mm	5
306-273 (EAN 3856024403528)	150 W	20250 lm	IP65	375 x 280 x 38 mm	5
306-274 (EAN 3856024403535)	200 W	27000 lm	IP65	196 x 62 x 146 mm	4

Značajke

5 godina jamstva, 50 000 h životni vijek

Features

5 year warranty, 50 000 h lifespan

Temperatura svjetla / Color temperature

6500 K

Nazivni napon / Input voltage

220-240 V~ 50/60 Hz

Kabel / Cable

H05RN-F 3G1 / 2,5 m

Životni vijek / Lifespan

25.000 h

Kut snopa svjetlosti / Beam angle

120°

Stupanj zaštite / IP grade

IP44

Temperatura svjetla / Color temperature

6500 K

Nazivni napon / Input voltage

220-240 V~ 50/60 Hz

Kabel / Cable

H05RN-F 3G1 / 2,5 m

Životni vijek / Lifespan

25.000 h

Kut snopa svjetlosti / Beam angle

120°

Stupanj zaštite / IP grade

IP44



šifra / art. no.	snaga / power	svjetlosni tok / luminous flux	kom./kutija / pcs/ctn
308-213 (EAN 3856024403764)	10 W	1 x 1000 lm	10
308-233 (EAN 3856024403771)	30 W	1 x 3200 lm	10
308-253 (EAN 3856024403801)	50 W	1 x 5400 lm	8

Značajke
H05RN-F kabel s IP44 šuko utikačem

Features
H05RN-F cable with IP44 Schuko plug

šifra / art. no.	snaga / power	svjetlosni tok / luminous flux	kom./kutija / pcs/ctn
308-433 (EAN 3856024403788)	1 x 30 W	1 x 3200 lm	2
308-533 (EAN 3856024403795)	2 x 30 W	2 x 3200 lm	2
308-553 (EAN 3856024403818)	2 x 50 W	2 x 5400 lm	2

Značajke
H05RN-F kabel s IP44 šuko utikačem

Teleskopski stalak s mogućnošću podešavanja visine

Features
H05RN-F cable with IP44 Schuko plug

Height adjustable tripod telescopic stand



AKUMULATORSKI LED REFLEKTORI RECHARGEABLE LED FLOODLIGHTS

Temperatura svjetla / Color temperature

6000 K

Baterija / Battery

18650 3.7V 2000 mAh

Stupanj zaštite / IP grade

IP44

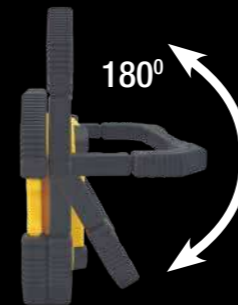

Rotirajuća ručka za 180°
/ 180° Rotating handle



LED indikator baterije
/ Battery led indicator



"Slim" dizajn / Slim design



Power bank funkcija
/ Power bank function

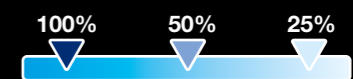
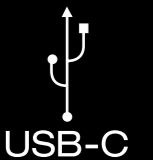

3 načina rada / 3 working modes

šifra / art. no. snaga / power

308-312
(EAN 3856024405829)

10 W

svjetlosni tok /
luminous flux

1000 lm

kom./kutija
/ pcs/ctn

24

Značajke

Sklopivi "slim" dizajn

IP44 Vodootporno kućište sa zaštićenim rubovima

Features

Foldable slim design

IP44 Waterproof housing with protective edges

Temperatura svjetla / Color temperature

6500 K

Baterija / Battery

18650 3.7V 5000 mAh

Stupanj zaštite / IP grade

IP44

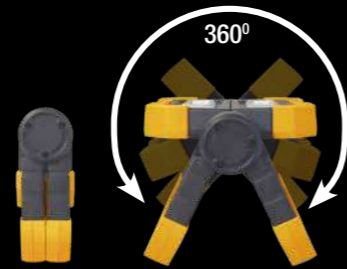

Rotacija 360° / 360° Rotating



Power bank funkcija / Power bank function



LED indikator baterije / Battery led indicator



Magnetni držač / Magnet holder

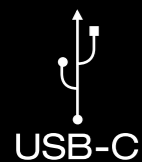

USB-C

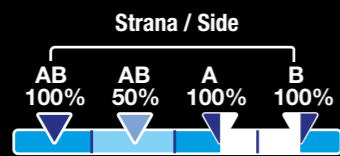

4 načina rada / 4 working modes

šifra / art. no.
308-313
(EAN 3856024405911)

snaga / power
10 W

svjetlosni tok / luminous flux
900 lm

kom./kutija / pcs/ctn
6

Značajke
Sklopivi "slim" dizajn
Čvrsto kućište sa zaštićenim rubovima

Features
Foldable slim design
Robust housing with protective edges

Temperatura svjetla / Color temperature

**4000 K / 6500 K /
crveno svjetlo / red light**

Baterija / Battery

18650 3.7V 9000 mAh

Stupanj zaštite / IP grade

IP44

5-20 h
operating time



COOL
WHITE
6500 K



NEUTRAL
WHITE
4000 K



RED
LIGHT

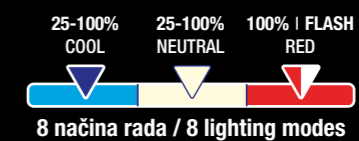

8 načina rada / 8 lighting modes

šifra / art. no.
308-314
(EAN 3856024407397)

snaga / power
30 W

svjetlosni tok / luminous flux
3000 lm

dimenzije / dimensions
240 x 190 x 310-1020 mm

kom./kutija / pcs/ctn
8

Značajke
Akumulatorski teleskopski LED reflektor
Čvrsto kućište sa zaštićenim rubovima

Features
LED rechargeable telescopic floodlight
Robust housing with protective edges



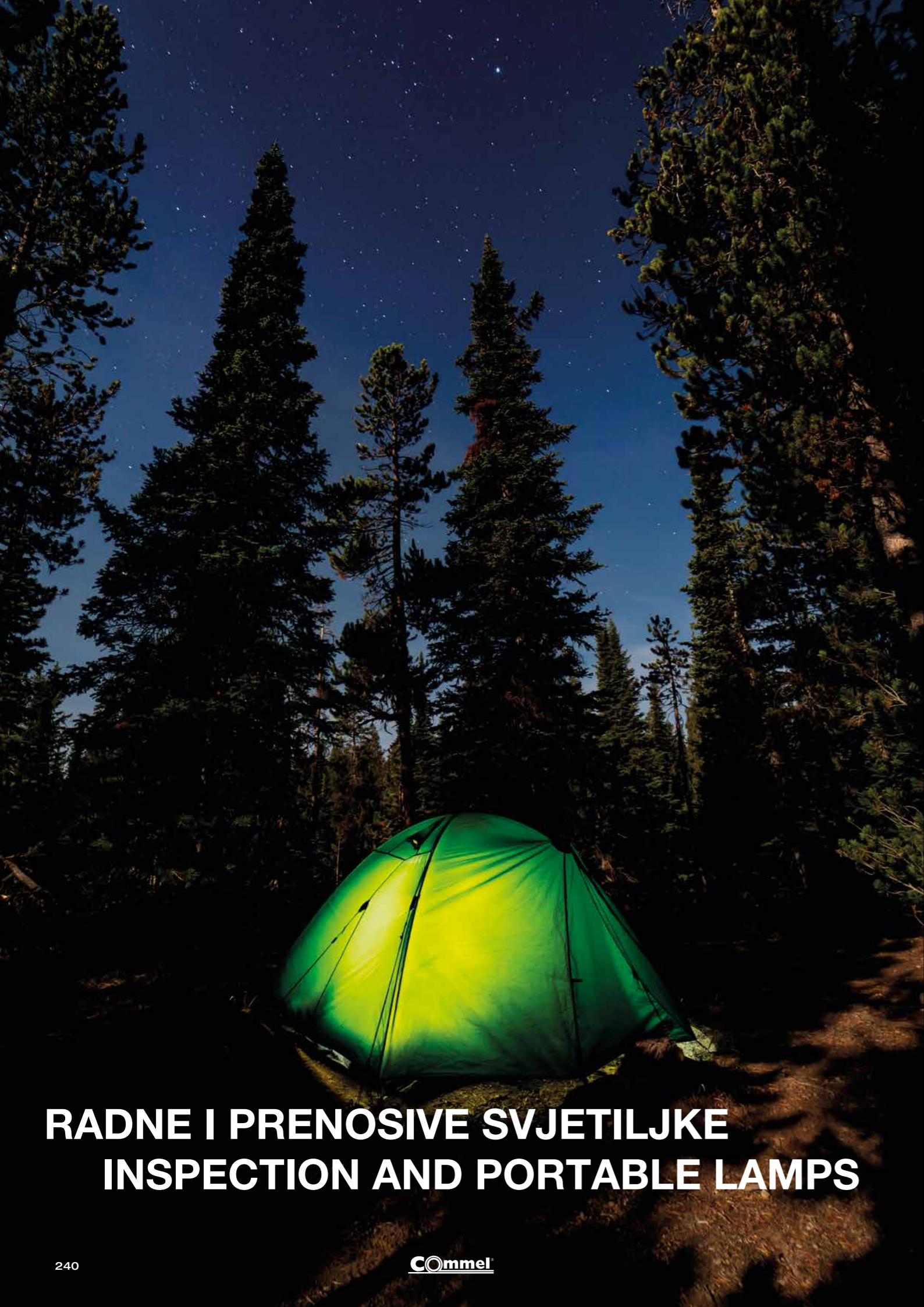

LED NAGLAVNE SVJETILJKE SA SENZOROM / LED HEADLIGHT WITH SENSOR

Kabel / Cable
USB

Stupanj zaštite / IP grade
IP20

Kom./kutija / Pcs/ctn
100

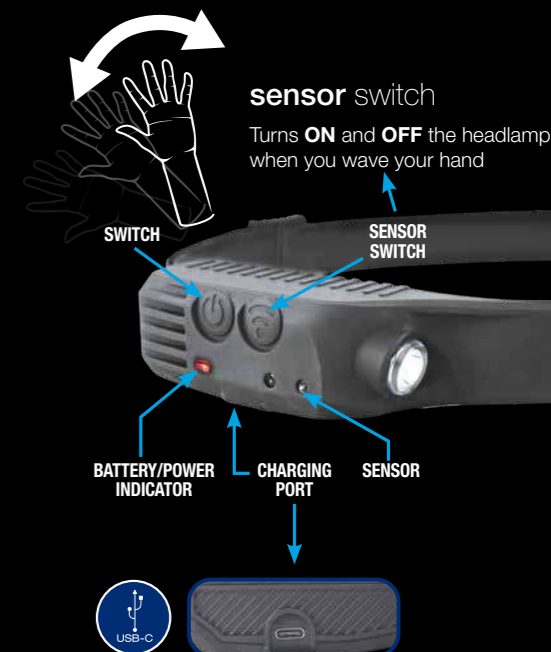

Baterija / Battery
Li-ion 3.7 V, 1200 mAh

šifra / art. no.	snaga / power	svjetlosni tok / luminous flux	autonomija / autonomy
401-213 (EAN 3856024407076)	4 W	280 lm	2 h

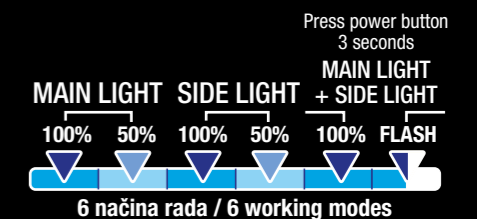

**RADNE I PRENOSIVE SVJETILJKE
INSPECTION AND PORTABLE LAMPS**

Značajke / Features
USB punjač, Senzorski prekidač / USB charger, Sensor switch
Uključivanje i isključivanje jednostavnim pokretom ruku / Turning the lamp ON or OFF by simple hand wave

Kabel / Cable
USB

Stupanj zaštite / IP grade
IPX5

Kom./kutija / Pcs/ctn
40

Nazivni napon / Input voltage
5 V 1 A

Kabel / Cable
USB

Stupanj zaštite / IP grade
IP44

Kom./kutija / Pcs/ctn
50



Baterija / Battery
Li-ion 3.7 V, 800 mAh

šifra / art. no.
401-212
(EAN 3856024402705)

snaga / power
5 W

svjetlosni tok / luminous flux
350 lm

autonomija / autonomy
4 h



Baterija / Battery
Li-ion 3.7 V, 800 mAh

šifra / art. no.
401-210
(EAN 3856024402507)

snaga / power
5 W

svjetlosni tok / luminous flux
300 lm

autonomija / autonomy
3 h



Baterija / Battery
Li-ion 3.7 V, 1500 mAh

šifra / art. no.
401-211
(EAN 3856024402699)

snaga / power
11 W

svjetlosni tok / luminous flux
500 lm

autonomija / autonomy
2,5 h

Značajke
USB punjač, Senzorski prekidač
Uključivanje i isključivanje jednostavnim pokretom ruku

Features
USB charger, Sensor switch
Turning the lamp ON or OFF by simple hand wave



Baterija / Battery
Li-ion 3.7 V, 1200 mAh

šifra / art. no.
401-020
(EAN 3858890449921)

snaga / power
3 W + COB LED 3 W

svjetlosni tok / luminous flux
250 lm

dimenzije / dimensions
27 x 19 x 162 mm

Značajke
COB LED 3 W + SMD LED 3 W, USB punjač
LED indikator stanja baterije, snažan magnetski držač

Features
COB LED 3 W + SMD LED 3 W, USB charger
Battery status LED indicator, powerful magnetic holder

MULTIFUNKCIJSKA MINI LED SVJETILJKA / MULTIFUNCTIONAL MINI LED LAMP

Kabel / Cable
USB-C

Stupanj zaštite / IP grade
IP44

Kom./kutija / Pcs/ctn
100



Baterija / Battery
Li-ion 3.7 V, 500 mAh

šifra / art. no.
401-021
(EAN 3856024405812)

snaga / power
5 W

svjetlosni tok / luminous flux
500 lm

temperatura svjetla / color temperature
6500 K

dimenzije / dimensions
60 x 45 x 20 mm

Značajke
Kompaktan dizajn, 4 načina rada, magnetni držač, utor za stalak, otvarač za boce, sklopivi stalak, karabiner

Features
Compact design, 4 working modes, magnet holder, rack slot, bottle opener, foldable stand, carabiner



Nazivni napon / Input voltage
5 V 1 A

Kabel / Cable
USB

Stupanj zaštite / IP grade
IP44

Kom./kutija / Pcs/ctn
50



Baterija / Battery
Li-ion 3.7 V, 2000 mAh

šifra / art. no. snaga / power svjetlosni tok / luminous flux dimenzije / dimensions
401-015 **COB LED 10 W 580 lm 34 x 378 mm**
(EAN 3858890449914)

Značajke Features
USB punjač, LED indikator stanja baterije **USB charger, battery status LED indicator**
Snažan magnetski držač, mogućnost rotacije 360° **Powerful magnetic holder 360° rotation capability**

Kabel / Cable
USB

Stupanj zaštite / IP grade
IP44

Kom./kutija / Pcs/ctn
100



Baterija / Battery
Lithium 3.7 V 1800 mAh

Glavno svjetlo / Main light XPE LED
100% 50% 25% RED FLASH 100%
6 načina rada / 6 working modes

šifra / art. no. snaga / power svjetlosni tok / luminous flux temperatura svjetla / color temperature dimenzije / dimensions
401-016 **10 W 800 lm 6500 K 28 x 36 x 148 mm**
(EAN 3856024405942)

Značajke Features
Rotacija 360°, metalna kuka, LED indikator baterije, magnetni držač, sekundarno svjetlo, crveno svjetlo **360° rotating, metal hanger, battery LED indicator, magnet holder, second light, red light**

Kabel / Cable
USB

Kom./kutija / Pcs/ctn
100



Glavno svjetlo / Main light COB LED
100% 50% FLASH 100% FLASH
5 načina rada / 5 working modes

šifra / art. no. snaga / power svjetlosni tok / luminous flux dimenzije / dimensions
401-017 **5 W 600 lm 41 x 163 mm**
(EAN 3856024407083)

Značajke Features
LED indikator baterije, sekundarno svjetlo **battery LED indicator, second light**



Baterija / Battery
Lithium 3.7 V 1200 mAh

MULTIFUNKCIONALNA LED RADNA SVJETILJKA / MULTIFUNCTIONAL LED WORK LIGHT

Kabel / Cable
USB

Stupanj zaštite / IP grade
IP20

Kom./kutija / Pcs/ctn
10

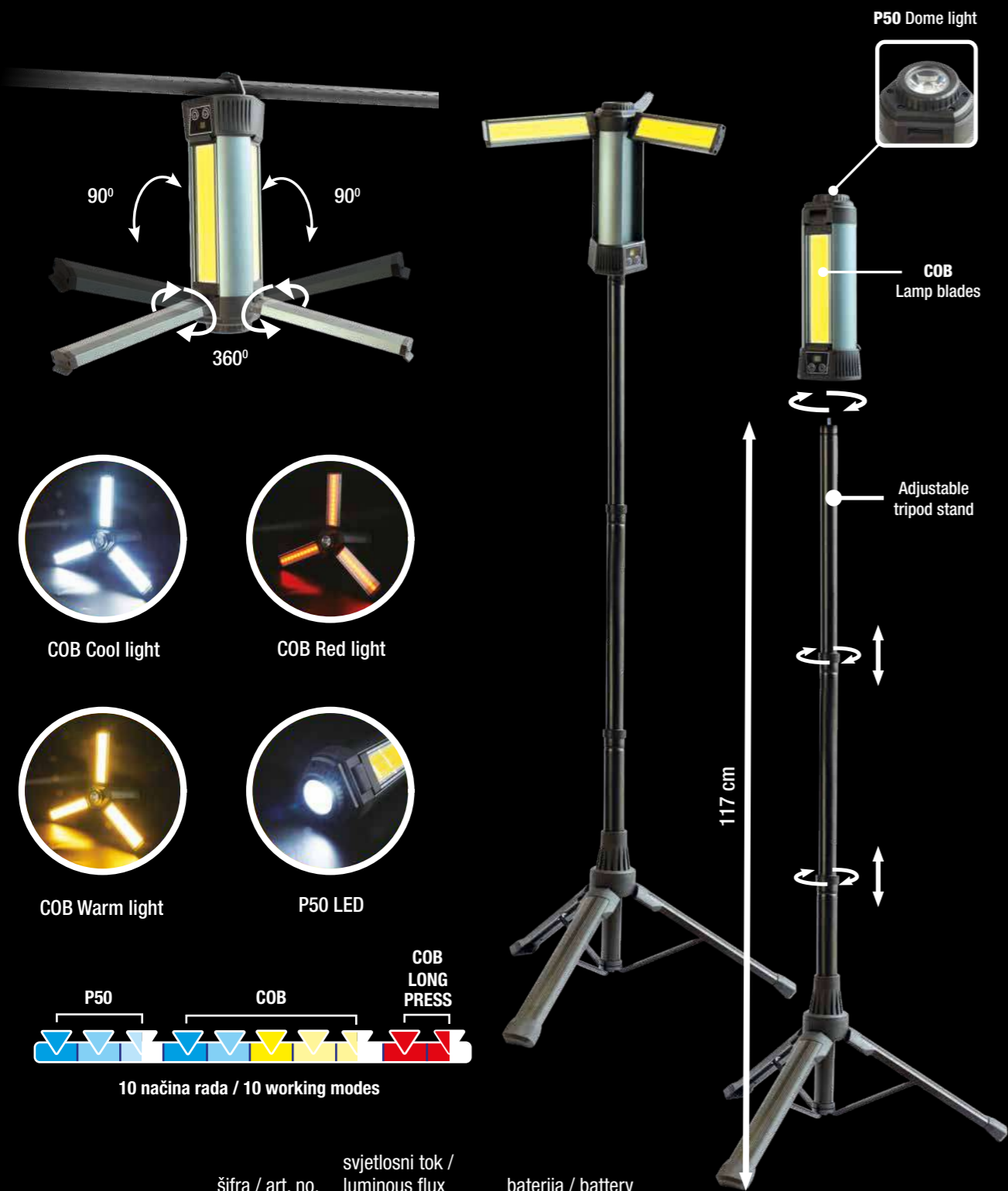

šifra / art. no.
308-315
(EAN 3856024408141)

svjetlosni tok / luminous flux
1500 lm

baterija / battery
Lithium 3.7 V 6000 mAh

Značajke
Rotacija 360° tijela svjetiljke + rotacija 90° svakog krilca, sakrivena kuka, LED indikator baterije, magnetni držač, sekundarno svjetlo, crveno svjetlo, funkcija powerbanka

Features
360° rotation of the lamp body + 90° rotation of each wing, hidden hook, LED battery indicator, magnetic holder, secondary light, red light, powerbank function

Nazivni napon / Input voltage
220-240 V~ 50 Hz

Kabel / Cable
H05RN-F 2x0,75 / 5 m

Stupanj zaštite / IP grade
IP44

Kom./kutija / Pcs/ctn
8

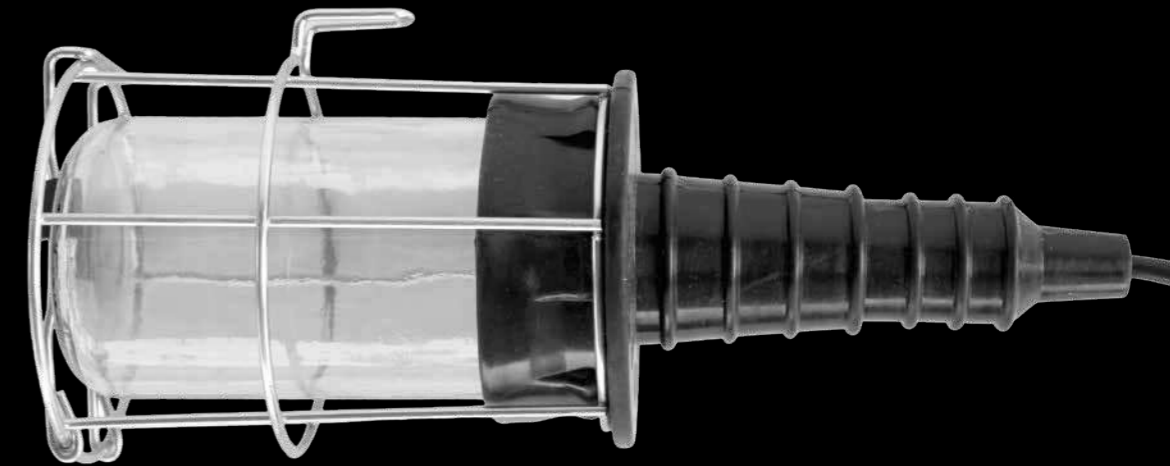

šifra / art. no.
340-010
(EAN 3858890442564)

snaga / power
max 60 W

tip grla / bulb socket
E27

stupanj zaštite / IP grade
IP20

Značajke
Metalna zaštitna košara

Features
Metal protective grille



šifra / art. no.
0885
(EAN 3859888558588)

snaga / power
max 60 W

tip grla / bulb socket
E27

stupanj zaštite / IP grade
IP20

Značajke
PVC zaštitna košara

Features
PVC protective grille



Stupanj zaštite / IP grade
IPX6

LED KAMPING SVJETILJKA / LED CAMPING LIGHT

Dimenzije / Dimensions
123 x 108 x 182 mm

Stupanj zaštite / IP grade
IP44

Kom./kutija / Pcs/ctn
12



šifra / art. no. snaga / power svjetlosni tok / luminous flux baterija / battery kom./kutija / pcs/ctn
401-711 1 W 180 lm Li-Polymer 3.7 V 2000 mAh 20
(EAN 3858890448382)

Značajke Features
3 razine osvjetljenja: 20% ; 50% ; 100%; do 20 h neprekidnog rada
Električna mreža za hvatanje komaraca
Vodootporna – IPX6, praktična kuka za vješanje
3 light modes: 20%, 50% and 100% ; Up to 20 h of continuous operation
Mosquito killer grid, Waterproof – IPX6, practical hanger

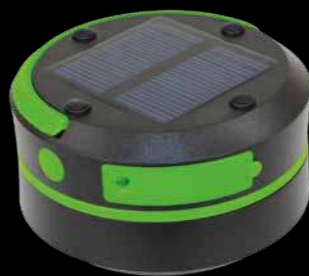

šifra / art. no. snaga / power svjetlosni tok / luminous flux baterija / battery kom./kutija / pcs/ctn
401-712 1 W 65 lm Lithium 3.7 V 800 mAh 20
(EAN 3858890448399)

Značajke Features
2 načina punjenja: solarni panel ili USB punjač
Dodatni izvor napajanja za elektroničke uređaje – power bank
Do 10 h neprekidnog rada, praktična sklopiva ručica
3 u 1: prenosiva ručna svjetiljka + kamp svjetiljka + SOS svjetiljka
2 razine osvjetljenja + SOS signalno svjetlo
2 charging ways: solar panel or USB charging
Power bank – additional power source for electronic devices
Up to 10 h of continuous operation, practical foldable handle
3 in 1: flashlight + camping lamp + SOS emergency lamp
2 light modes + SOS flashing

100% COOL 100% WARM 100% NEUTRAL FLASH RED
4 načina rada / 4 working modes

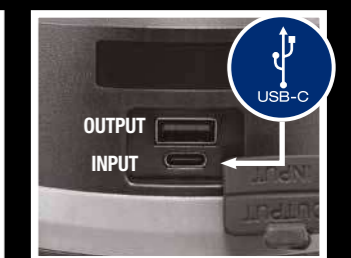
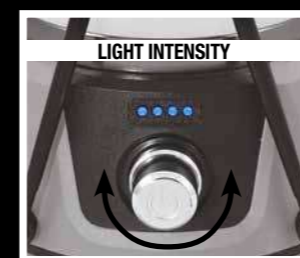

šifra / art. no. snaga / power svjetlosni tok / luminous flux baterija / battery kom./kutija / pcs/ctn
401-713 10 W 580 lm Lithium 3.7 V 4000 mAh
(EAN 3856024407403)

Značajke Features
Ručica za nošenje ili vješanje, indikator stanja baterije
Dodatni izvor napajanja za elektroničke uređaje – power bank
PVC protective grille
Power bank – additional power source for electronic devices



NOĆNA SVJETLA NIGHT LIGHTS

NOĆNO SVJETLO S PROJEKTOROM / NIGHT LIGHT WITH PROJECTOR



šifra / art. no. (EAN 3856024403382)	snaga / power	nazivni napon / input voltage	kom./kutija / pcs/ctn
390-203	0.7 W	220-240 V ~ 50 Hz	10



šifra / art. no. (EAN 3858890440676)	snaga / power	nazivni napon / input voltage	kom./kutija / pcs/ctn
390-201	0.4 W	220-240 V ~ 50 Hz	20

Značajke / Features
 Ugrađeni fotosenzor automatski uključuje i isključuje svjetlo, ovisno o razini ambijentalnog osvjetljenja.
 A built-in photosensor automatically switches on and off a nightlight, depending on ambient brightness.

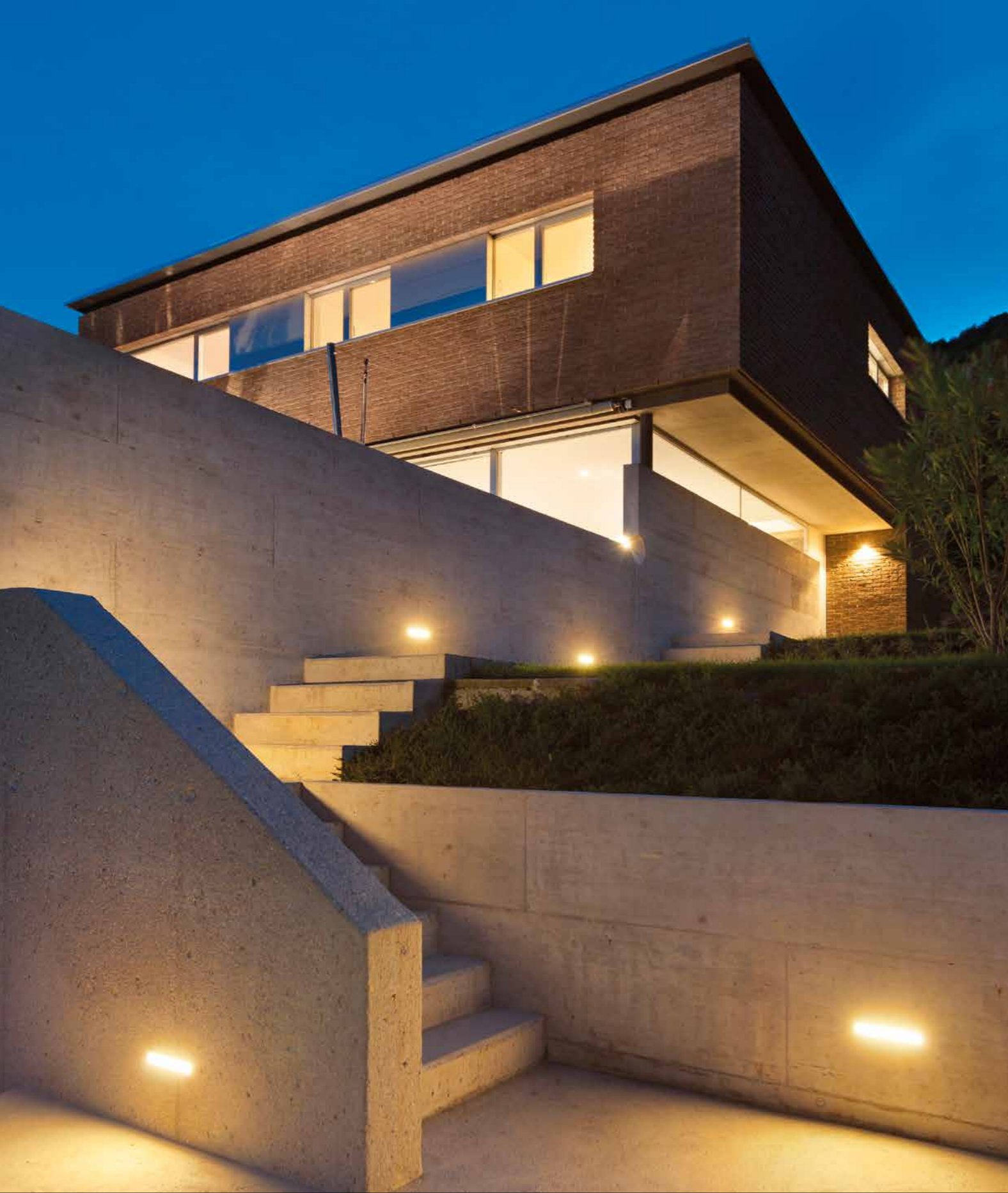

DETEKTORI POKRETA I LUKSOMATI MOTION DETECTORS AND PHOTOCELL SENSORS

INFRACRVENI DETEKTORI POKRETA / INFRARED MOTION DETECTORS

Nazivni napon / Voltage
220-240 V~ 50/60 Hz

Supanj zaštite / IP grade
IP20

Kom.kutija / Pcs.ctn.
50



šifra / art. no. (EAN 3858883835250)	boja / color	kut detekcije / detection angle	domet detekcije / detection range	nazivno opterećenje / rated load
311-151	●	360°	12 m	1200 W

Nazivni napon / Voltage
220-240 V~ 50/60 Hz

Supanj zaštite / IP grade
IP20

Kom.kutija / Pcs.ctn.
50



šifra / art. no. (EAN 3858883835236)	boja / color	kut detekcije / detection angle	domet detekcije / detection range	nazivno opterećenje / rated load
311-101	●	360°	6 m	1200 W
311-102	○	360°	6 m	1200 W

Nazivni napon / Voltage
220-240 V~ 50/60 Hz

Supanj zaštite / IP grade
IP20

Kom.kutija / Pcs.ctn.
50



šifra / art. no. (EAN 3858890447217)	boja / color	kut detekcije / detection angle	domet detekcije / detection range	nazivno opterećenje / rated load
311-105	●	360°	6 m	2000 W

INFRACRVENI DETEKTORI POKRETA / INFRARED MOTION DETECTORS

Nazivni napon / Voltage
220-240 V~ 50/60 Hz

Supanj zaštite / IP grade
IP20

Kom.kutija / Pcs.ctn.
24



šifra / art. no.	boja / color	kut detekcije / detection angle	domet detekcije / detection range	nazivno opterećenje / rated load
311-107 (EAN 3856024407175)	●	360°	8 m	400 W

Nazivni napon / Voltage
220-240 V~ 50/60 Hz

Supanj zaštite / IP grade
IP65

Kom.kutija / Pcs.ctn.
24



šifra / art. no.	boja / color	kut detekcije / detection angle	domet detekcije / detection range	nazivno opterećenje / rated load
311-109 (EAN 3856024407182)	●	360°	8 m	2000 W

Nazivni napon / Voltage
220-240 V~ 50/60 Hz

Supanj zaštite / IP grade
IP20

Promjer otvora za ugradnju /
Mounting hole diameter
65 mm

Kom.kutija / Pcs.ctn.
50



šifra / art. no.	boja / color	kut detekcije / detection angle	domet detekcije / detection range	nazivno opterećenje / rated load
311-201 (EAN 3858883835274)	●	360°	6 m	1200 W

Nazivni napon / Voltage
220-240 V~ 50/60 Hz

Supanj zaštite / IP grade
IP20

Promjer otvora za ugradnju /
Mounting hole diameter
40 mm

Kom.kutija / Pcs.ctn.
24

šifra / art. no.	boja / color	kut detekcije / detection angle	domet detekcije / detection range	nazivno opterećenje / rated load
311-203 (EAN 3856024407212)	●	360°	8 m	800 W

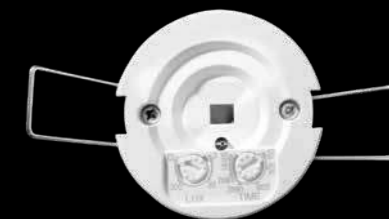

INFRACRVENI DETEKTOR POKRETA ZA KORIDOR / INFRARED MOTION DETECTOR FOR CORRIDOR

Nazivni napon / Voltage
220-240 V~ 50/60 Hz

Supanj zaštite / IP grade
IP20

Kom.kutija / Pcs.ctn.
24



šifra / art. no.	boja / color	kut detekcije / detection angle	domet detekcije / detection range	nazivno opterećenje / rated load
311-161 (EAN 3856024407205)	●	360°	30 m	2000 W

INFRACRVENI DETEKTOR PRISUTNOSTI / INFRARED PRESENCE SENSOR

Nazivni napon / Voltage
220-240 V~ 50/60 Hz

Supanj zaštite / IP grade
IP20

Kom.kutija / Pcs.ctn.
24



šifra / art. no.	boja / color	kut detekcije / detection angle	domet detekcije / detection range	nazivno opterećenje / rated load
311-111 (EAN 3856024407199)	●	360°	20 m	2000 W

INFRACRVENI DETEKTORI POKRETA / INFRARED MOTION DETECTORS



Nazivni napon / Voltage
220-240 V~ 50/60 Hz

Supanj zaštite / IP grade
IP44

Kom.kutija / Pcs.ctn.
50

šifra / art. no.
310-101
(EAN 3858883835212)

boja / color
●

kut detekcije /
detection angle
180°

domet detekcije /
detection range
12 m

nazivno opterećenje /
rated load
1200 W

šifra / art. no.
310-102
(EAN 3858883835229)

○

180°

12 m

1200 W



Montaža na strop ili zid
Installation on the ceiling or wall

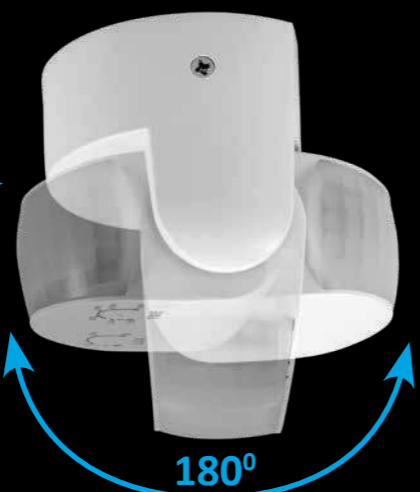

Nazivni napon / Voltage
220-240 V~ 50/60 Hz

Supanj zaštite / IP grade
IP65

Kom.kutija / Pcs.ctn.
24

šifra / art. no.
310-105
(EAN 3856024407168)

●

kut detekcije /
detection angle
180°

domet detekcije /
detection range
12 m

nazivno opterećenje /
rated load
1200 W



Ugradnja u kutiju Ø 60 mm
Mounting in Ø 60 mm wall backbox



Nazivni napon / Voltage
220-240 V~ 50/60 Hz

Supanj zaštite / IP grade
IP20

Kom.kutija / Pcs.ctn.
100

šifra / art. no.
312-101
(EAN 3858890440881)

●

kut detekcije /
detection angle
160°

domet detekcije /
detection range
9 m

nazivno opterećenje /
rated load
500 W

SENZORSKI PREKIDAČ / SENSOR SWITCH

Nazivni napon / Voltage
220-240 V~ 50/60 Hz

Supanj zaštite / IP grade
IP20

Kom.kutija / Pcs.ctn.
100

šifra / art. no.
311-205
(EAN 3858890447613)

nazivna struja /
rated current
5 A

domet detekcije /
detection range
5-6 cm

nazivno opterećenje /
rated load
500 W

Značajke
Senzor kratkog dometa

Features
Short-range sensor

Uključivanje i isključivanje svjetla jednostavnim pokretom ruke

Turn the light on and off with a simple hand movement



MIKROVALNI DETEKTOR POKRETA / MICROWAVE MOTION DETECTOR

Nazivni napon / Voltage
220-240 V~ 50/60 Hz

Supanj zaštite / IP grade
IP20

Kom.kutija / Pcs.ctn.
100

šifra / art. no.
313-101
(EAN 3858890440898)

kut detekcije /
detection angle
360°

domet detekcije /
detection range
8 m

nazivno opterećenje /
rated load
500 W

Značajke
Senzori visoke osjetljivosti, signal prolazi kroz tanke stijene zidova ili staklo

Montaža unutar kućišta svjetiljke, spuštene stropove, razvodne kutije

Features
High sensitivity sensors, signal passes through thin walls or glass
Mounting inside a lamp housing, dropped ceilings or junction boxes



LUKSOMATI / PHOTOCELL SENSORS

Nazivni napon / Voltage
220-240 V~ 50/60 Hz

Supanj zaštite / IP grade
IP44

Kom.kutija / Pcs.ctn.
100

šifra / art. no.
314-101
(EAN 3858890443431)

nazivna struja /
rated current
6 A

Nazivni napon / Voltage
220-240 V~ 50/60 Hz

Supanj zaštite / IP grade
IP44

Kom.kutija / Pcs.ctn.
100

šifra / art. no.
314-201
(EAN 3858890443448)

nazivna struja /
rated current
10 A





GRLA I PRIBOR ZA RASVJETU BULB SOCKETS AND LIGHTING ACCESSORIES

PBT GRLA / PBT BULB SOCKETS

Nazivni napon / Voltage

250 V ~

Maks. temperatura / Max. temperature

210°C

Materijal kućišta / Housing material

PBT

Kom.kutija / Pcs.ctn.

50



šifra / art. no.	boja / color	baza / base	maks. opterećenje / max. load	dimenzije / dimensions
016-105 (EAN 3858890449846)	●	E14	2 A	26 x 56 mm
016-115 (EAN 3858890449853)	○	E14	2 A	26 x 56 mm
016-101 (EAN 3858890449808)	●	E27	4 A	38.5 x 59 mm
016-111 (EAN 3858890449815)	○	E27	4 A	38.5 x 59 mm



Nazivni napon / Voltage

250 V ~

Maks. temperatura / Max. temperature

210°C

Materijal kućišta / Housing material

PBT

Kom.kutija / Pcs.ctn.

50

šifra / art. no.	boja / color	baza / base	maks. opterećenje / max. load	dimenzije / dimensions
016-106 (EAN 3858890449860)	●	E14	2 A	43 x 55 mm
016-116 (EAN 3858890449877)	○	E14	2 A	43 x 55 mm
016-102 (EAN 3858890449822)	●	E27	4 A	57 x 59 mm
016-112 (EAN 3858890449839)	○	E27	4 A	57 x 59 mm

GRLO E27 S KABELOM / E27 BULB SOCKET WITH CABLE



Nazivni napon / Voltage
250 V ~

Maks. temperatura / Max. temperature
210°C

Materijal kućišta / Housing material
PBT

Kom.kutija / Pcs.ctn.
25

šifra / art. no.	boja / color	baza / base	maks. opterećenje / max. load	dužina kabela / cable length
016-703 (EAN 3856024406765)	●	E27	2 A	17 cm
016-704 (EAN 3856024406772)	○	E27	2 A	17 cm

GRLO GU10 / GU10 BULB SOCKET



Nazivni napon / Voltage
250 V ~

Materijal kućišta / Housing material
keramika / ceramic

Kom.kutija / Pcs.ctn.
50

šifra / art. no.	boja kabela / cable color	baza / base	maks. opterećenje / max. load	dužina vodiča / wire length
016-401 (EAN 3856024402248)	●	GU10	2 A	9 cm

KERAMIČKA GRLO / CERAMIC BULB SOCKETS

Nazivni napon / Voltage
750 V ~

Maks. temperatura / Max. temperature
400°C

Materijal kućišta / Housing material
keramika / ceramic

Kom.kutija / Pcs.ctn.
100



šifra / art. no.	baza / base	maks. opterećenje / max. load	dimenzije / dimensions
016-135 (EAN 3858890449907)	E40	16 A	54 x 69 mm

Nazivni napon / Voltage
250 V ~

Maks. temperatura / Max. temperature
400°C

Materijal kućišta / Housing material
keramika / ceramic

Kom.kutija / Pcs.ctn.
400



šifra / art. no.	baza / base	maks. opterećenje / max. load	dimenzije / dimensions
016-131 (EAN 3858890449884)	E27	4 A	40 x 46 mm

Nazivni napon / Voltage
250 V ~

Maks. temperatura / Max. temperature
400°C

Materijal kućišta / Housing material
keramika / ceramic

Kom.kutija / Pcs.ctn.
400



šifra / art. no.	baza / base	maks. opterećenje / max. load	dimenzije / dimensions
016-132 (EAN 3858890449891)	E27	4 A	40 x 46 mm





Commel - Zagreb d.o.o.; Samoborska cesta 143, 10090 Zagreb, Croatia
T: +385 1 3436 000, F: +385 1 3436 010, www.commel.hr, info@commel.hr