



# **Video Intercom Main Station**

**Operation Guide**

# Legal Information

©2020 Hangzhou Hikvision Digital Technology Co., Ltd. All rights reserved.

## About this Manual

The Manual includes instructions for using and managing the Product. Pictures, charts, images and all other information hereinafter are for description and explanation only. The information contained in the Manual is subject to change, without notice, due to firmware updates or other reasons. Please find the latest version of this Manual at the Hikvision website ( <https://www.hikvision.com/> ).

Please use this Manual with the guidance and assistance of professionals trained in supporting the Product.

## Trademarks

**HIKVISION** and other Hikvision's trademarks and logos are the properties of Hikvision in various jurisdictions.

Other trademarks and logos mentioned are the properties of their respective owners.

## Disclaimer

TO THE MAXIMUM EXTENT PERMITTED BY APPLICABLE LAW, THIS MANUAL AND THE PRODUCT DESCRIBED, WITH ITS HARDWARE, SOFTWARE AND FIRMWARE, ARE PROVIDED "AS IS" AND "WITH ALL FAULTS AND ERRORS". HIKVISION MAKES NO WARRANTIES, EXPRESS OR IMPLIED, INCLUDING WITHOUT LIMITATION, MERCHANTABILITY, SATISFACTORY QUALITY, OR FITNESS FOR A PARTICULAR PURPOSE. THE USE OF THE PRODUCT BY YOU IS AT YOUR OWN RISK. IN NO EVENT WILL HIKVISION BE LIABLE TO YOU FOR ANY SPECIAL, CONSEQUENTIAL, INCIDENTAL, OR INDIRECT DAMAGES, INCLUDING, AMONG OTHERS, DAMAGES FOR LOSS OF BUSINESS PROFITS, BUSINESS INTERRUPTION, OR LOSS OF DATA, CORRUPTION OF SYSTEMS, OR LOSS OF DOCUMENTATION, WHETHER BASED ON BREACH OF CONTRACT, TORT (INCLUDING NEGLIGENCE), PRODUCT LIABILITY, OR OTHERWISE, IN

CONNECTION WITH THE USE OF THE PRODUCT, EVEN IF HIKVISION HAS BEEN ADVISED OF THE POSSIBILITY OF SUCH DAMAGES OR LOSS.



YOU ACKNOWLEDGE THAT THE NATURE OF INTERNET PROVIDES FOR INHERENT SECURITY RISKS, AND HIKVISION SHALL NOT TAKE ANY RESPONSIBILITIES FOR ABNORMAL OPERATION, PRIVACY LEAKAGE OR OTHER DAMAGES RESULTING FROM CYBER-ATTACK, HACKER ATTACK, VIRUS INSPECTION, OR OTHER INTERNET SECURITY RISKS; HOWEVER, HIKVISION WILL PROVIDE TIMELY TECHNICAL SUPPORT IF REQUIRED.

YOU AGREE TO USE THIS PRODUCT IN COMPLIANCE WITH ALL APPLICABLE LAWS, AND YOU ARE SOLELY RESPONSIBLE FOR ENSURING THAT YOUR USE CONFORMS TO THE APPLICABLE LAW. ESPECIALLY, YOU ARE RESPONSIBLE, FOR USING THIS PRODUCT IN A MANNER THAT DOES NOT INFRINGE ON THE RIGHTS OF THIRD PARTIES, INCLUDING WITHOUT LIMITATION, RIGHTS OF PUBLICITY, INTELLECTUAL PROPERTY RIGHTS, OR DATA PROTECTION AND OTHER PRIVACY RIGHTS. YOU SHALL NOT USE THIS PRODUCT FOR ANY PROHIBITED END-USES, INCLUDING THE DEVELOPMENT OR PRODUCTION OF WEAPONS OF MASS DESTRUCTION, THE DEVELOPMENT OR PRODUCTION OF CHEMICAL OR BIOLOGICAL WEAPONS, ANY ACTIVITIES IN THE CONTEXT RELATED TO ANY NUCLEAR EXPLOSIVE OR UNSAFE NUCLEAR FUEL-CYCLE, OR IN SUPPORT OF HUMAN RIGHTS ABUSES.

IN THE EVENT OF ANY CONFLICTS BETWEEN THIS MANUAL AND THE APPLICABLE LAW, THE LATER PREVAILS.

# Symbol Conventions

The symbols that may be found in this document are defined as follows.

Symbol	Description
 <b>Danger</b>	Indicates a hazardous situation which, if not avoided, will or could result in death or serious injury.
 <b>Caution</b>	Indicates a potentially hazardous situation which, if not avoided, could result in equipment damage, data loss, performance degradation, or unexpected results.
 <b>Note</b>	Provides additional information to emphasize or supplement important points of the main text.

# Regulatory Information

## FCC Information

Please take attention that changes or modification not expressly approved by the party responsible for compliance could void the user's authority to operate the equipment.

FCC compliance: This equipment has been tested and found to comply with the limits for a Class B digital device, pursuant to part 15 of the FCC Rules. These limits are designed to provide reasonable protection against harmful interference in a residential installation. This equipment generates, uses and can radiate radio frequency energy and, if not installed and used in accordance with the instructions, may cause harmful interference to radio communications. However, there is no guarantee that interference will not occur in a particular installation. If this equipment does cause harmful interference to radio or television reception, which can be determined by turning the equipment off and on, the user is encouraged to try to correct the interference by one or more of the following measures:

- Reorient or relocate the receiving antenna.
- Increase the separation between the equipment and receiver.
- Connect the equipment into an outlet on a circuit different from that to which the receiver is connected.
- Consult the dealer or an experienced radio/TV technician for help.

## FCC Conditions

This device complies with part 15 of the FCC Rules. Operation is subject to the following two conditions:

- This device may not cause harmful interference.
- This device must accept any interference received, including interference that may cause undesired operation.

### EU Conformity Statement



This product and - if applicable - the supplied accessories too are marked with "CE" and comply therefore with the applicable harmonized European standards listed under the EMC Directive 2014/30/EU, LVD Directive 2014/35/EU, the RoHS Directive 2011/65/EU.



2012/19/EU (WEEE directive): Products marked with this symbol cannot be disposed of as unsorted municipal waste in the European Union. For proper recycling, return this product to your local supplier upon the purchase of equivalent new equipment, or dispose of it at designated collection points. For more information see: <http://www.recyclethis.info> .



2006/66/EC (battery directive): This product contains a battery that cannot be disposed of as unsorted municipal waste in the European Union. See the product documentation for specific battery information. The battery is marked with this symbol, which may include lettering to indicate cadmium (Cd), lead (Pb), or mercury (Hg). For proper recycling, return the battery to your supplier or to a designated collection point. For more information see: <http://www.recyclethis.info> .

### Industry Canada ICES-003 Compliance

This device meets the CAN ICES-3 (B)/NMB-3(B) standards requirements.

# Contents

1 Appearance .....	1
2 Terminal Description .....	4
3 Installation .....	6
3.1 Table Bracket(Optional) .....	6
3.2 Accessory Installation(Optional) .....	6
3.2.1 Install Speaker .....	6
3.2.2 Install Goose Neck Microphone .....	8
3.3 Wall Mounting .....	9
3.4 Table Mounting .....	10
4 Local Operation .....	11
4.1 Call Settings .....	11
4.1.1 Call Resident .....	11
4.1.2 Receive Call .....	11
4.1.3 View Call Logs .....	12
4.2 Live View .....	12
4.3 The Third-Party App Settings .....	13
4.3.1 Install the App .....	13
4.3.2 Uninstall the App .....	14
4.4 Information Management .....	14
5 Remote Operation via the client software .....	16
5.1 View Live Video of Door Station and Outer Door Station .....	16
5.2 View Call Logs .....	16

5.3 Release Notice .....	17
5.4 Search Video Intercom Information .....	19
5.4.1 Search Call Logs .....	19
5.4.2 Search Notice .....	21
A. Communication Matrix and Device Command .....	23

# 1 Appearance

## Front Panel

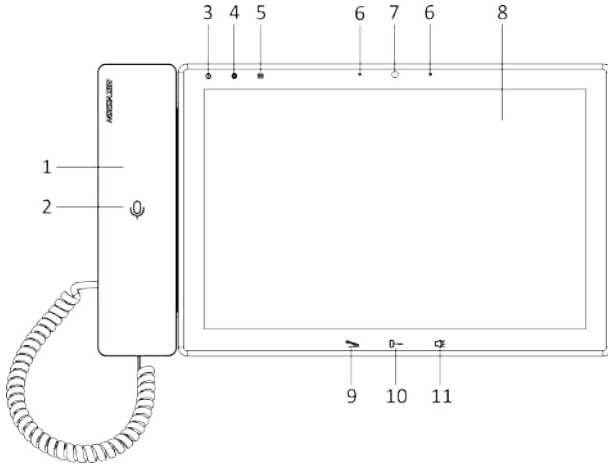

**Figure 1-1 Front Panel**

**Table 1-1 Description**

No.	Description	No.	Description
1	Phone	7	Camera
2	Phone Indicator(Reserved)	8	Screen
3	Power Indicator	9	Call/Hang Up Button
4	Alarm Indicator	10	Unlock Button
5	Information Indicator	11	Speaker Button
6	Microphone		

 **Note**

You can hold the unlock button to unlock lock 1, and press the unlock button to unlock lock 2.

**Top Panel and Rear Panel**

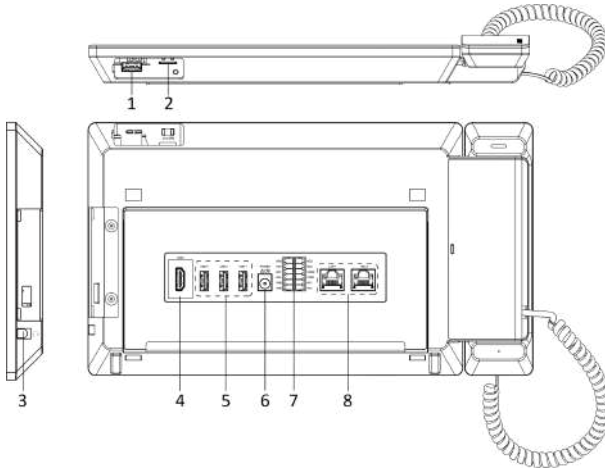
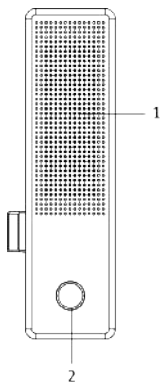

**Figure 1-2 Top Panel and Rear Panel**

**Table 1-2 Description**

No.	Description	No.	Description
1	Goose Neck Microphone Port	5	USB Interface
2	SD Card Slot	6	Power Interface
3	Earphone Interface	7	Terminals
4	HDMI	8	Network Interface

### Speaker(Optional)



**Figure 1-3 Speaker**  
**Table 1-3 Description**

Description	No.	Description
Speaker	2	Fingerprint Module

## 2 Terminal Description

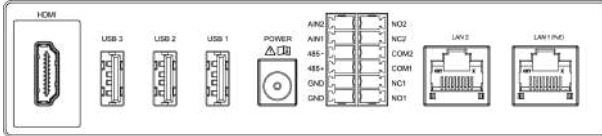

**Figure 2-1 Terminal Description**  
**Table 2-1 Terminal Description**

Name	Interface	Description
Video Interface	HDMI	HDMI Signal Output
USB Interface	USB 1	USB Interface  <b>Note</b> USB3 is used to debugging only. It cannot connect to USB flash drive.
	USB 2	
	USB 3	
Power Interface	POWER	12 VDC Power Input
Terminal	NO1	Alarm Output 1(NO)
	NC1	Alarm Output 1(NC)
	COM1	Common Interface
	NO2	Alarm Output 2(NO)
	NC2	Alarm Output 2(NC)
	COM2	Common Interface
	AIN1	Alarm Input 1
	AIN2	Alarm Input 2
	485+	RS-485 Communication Interfaces
	485-	
GND	Grounding	

## Video Intercom Main Station Operation Guide

---

<b>Name</b>	<b>Interface</b>	<b>Description</b>
	GND	Grounding
Network Interface	LAN1(PoE)	Network Interface (Support PoE)
	LAN2	Network Interface (Reserved)

## 3 Installation

- Make sure the device in the package is in good condition and all the assembly parts are included.
- The power supply the door station support is 12 VDC. Please make sure your power supply matches your door station.
- Make sure all the related equipment is power-off during the installation.
- Check the product specification for the installation environment.

### 3.1 Table Bracket(Optional)

The device supports table mounting and wall mounting. The dimensions of the table bracket(optional) is shown as below.

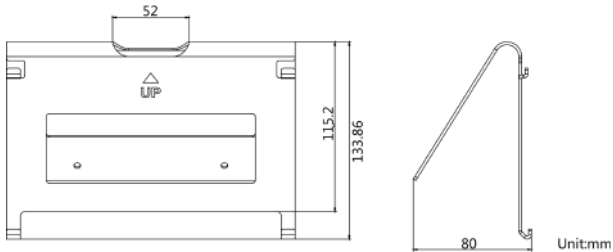

Figure 3-1 Table Bracket

### 3.2 Accessory Installation(Optional)

Before installing the device on the wall or on the table, you should install the accessories first.

---

 **Note**

Ask our technique supports and sales and purchase mounting plate, speaker and goose neck microphone.

---

#### 3.2.1 Install Speaker

**Steps**

1. Loose 2 screws on the rear panel of the device.

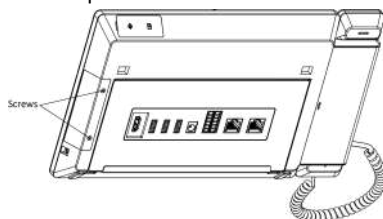

**Figure 3-2 Loose the screws**

2. Remove the cover from the device and install the speaker to the main station.

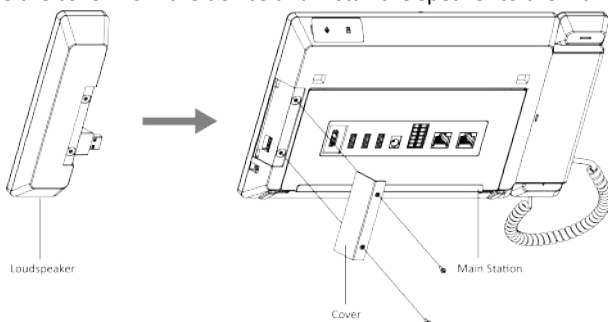

**Figure 3-3 Install the Speaker**

3. Use 4 screws to secure the speaker to the main station with the cover.

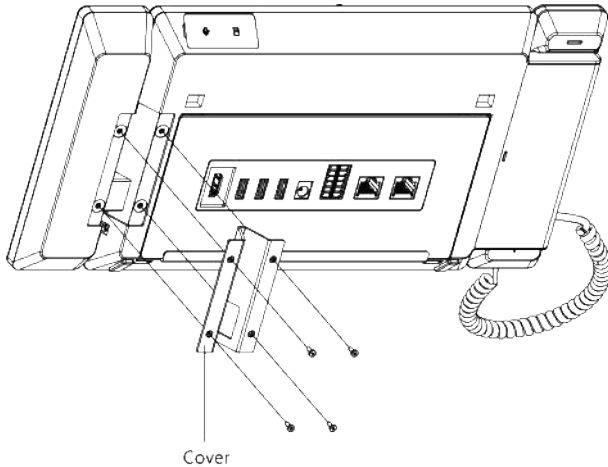

**Figure 3-4 Secure the Speaker**

---

 **Note**

- The speaker and earphone can not be used at the same time. If you want to use the earphone, you should remove the speaker.
  - When using earphones, the small size of the earphone plug should be selected. The size of the plug should be smaller than 7 mm.
- 

### 3.2.2 Install Goose Neck Microphone

If you want to use the goose neck microphone to create two-way audio communication.

#### Steps

1. Remove the cover of the device on the top panel.
2. Insert the goose neck microphone to the interface.

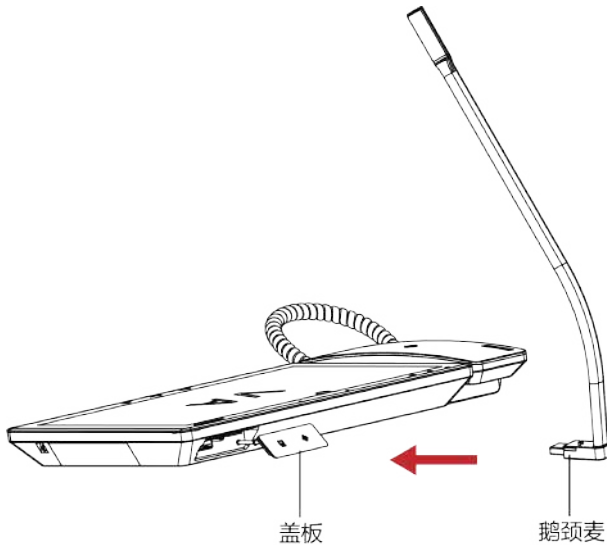

Figure 3-5 Install the Goose Neck Microphone

## 3.3 Wall Mounting

### Before You Start

#### Note

- Tools that you need to prepare for installation: Drill (6).
- Make sure all the related equipment is power-off during the installation.

### Steps

1. Place the table bracket on the wall. Mark the screw holes' position with a marker, and take out the the table bracket. Drill 4 holes according to the marks on the wall, and insert the expansion sleeves into the screw holes.
2. Secure the table bracket on the wall with 4 screws.
3. Hook the device to the table bracket tightly by inserting the hooks into the slots on the rear panel of the device,during which the lock catch will be locked automatically.

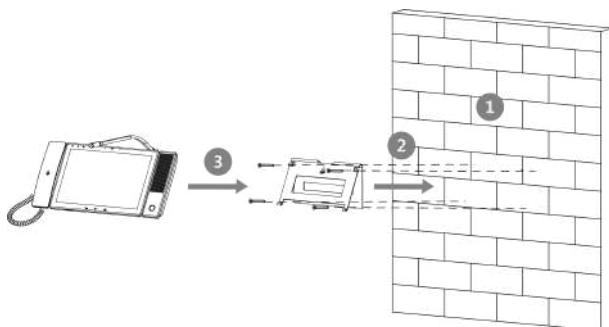

Figure 3-6 Wall Mounting

## 3.4 Table Mounting

### Steps

1. Wiring the device and smooth the cables across the cable hole.

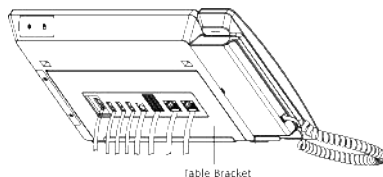

Figure 3-7 Smooth the Cable

2. Adjust the table bracket to the right angle and put the device on the right position.

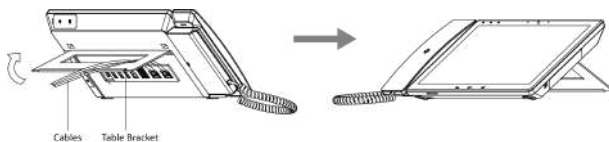

Figure 3-8 Adjust the Table Bracket

---

 **Note**

Recommend the use of the table bracket: the maximum opening angle used.

---

## 4 Local Operation

### 4.1 Call Settings

#### 4.1.1 Call Resident

Call the indoor station via the main station.

##### Steps

1. Tap **Call** →  to enter the call page.

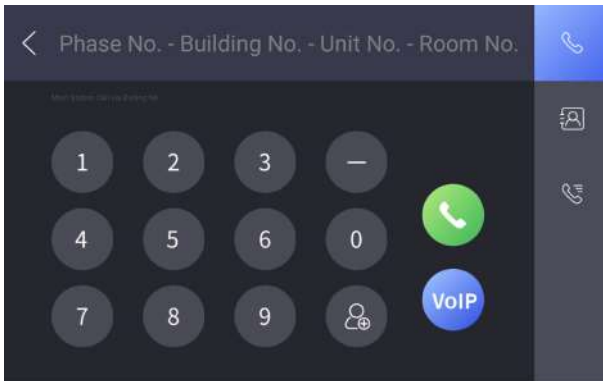

**Figure 4-1 Call Page**

2. Enter the calling number to call.

---

##### **Note**

- The calling number format should be x-x-x-xxx. For example, the calling number of Community 1, Building 2, Unit 3, and Room 405 is 1-2-3-405. Tap the call button to start an audiovisual call.
  - The community No. can be omitted.
- 

#### 4.1.2 Receive Call

The main station can receive the call from the indoor station, the door station, and the other main station.

When the main station receives the call from the other device, tap the receive call button to receive the call. Or tap the hang up button to end the call.

During the call, you can tap the unlock button to unlock the door remotely.

---

### **Note**

The maximum call duration between the main station and the indoor station is 120 s.

---

### 4.1.3 View Call Logs

View call logs of the main station.

#### Steps

1. Tap **Call** →  on the main page.

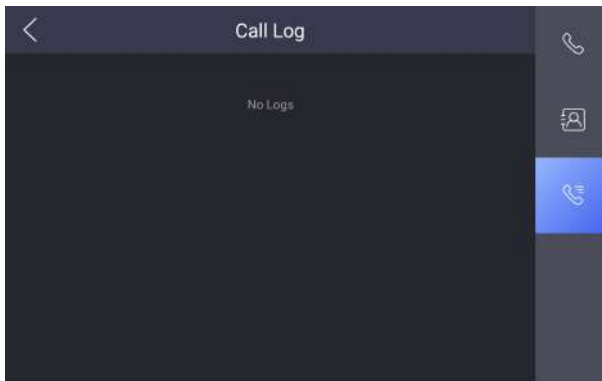

**Figure 4-2 Call Log Page**

2. View the call logs.

### **Note**

Up to 2000 call logs can be viewed.

---

3. **Optional:** Hold one of the call logs to clear all call logs or delete the select call log.

## 4.2 Live View

View the live videos of other devices from the main station.

### Steps

1. Tap **Live View** on the main page.

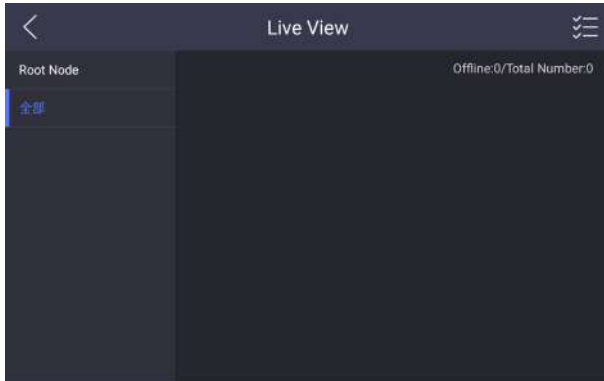

Figure 4-3 Live View Page

2. View the live videos of other devices.
3. **Optional:** Tap the unlock button to unlock the door.

## 4.3 The Third-Party App Settings

### 4.3.1 Install the App

Install the third-party App to your device.

#### Steps

1. Tap **Configuration** →  → **Configuration** .
2. Enter the configuration password.

---

 **Note**

By default, the configuration password is the activation password.

---

3. Tap  to view the third-party apps.

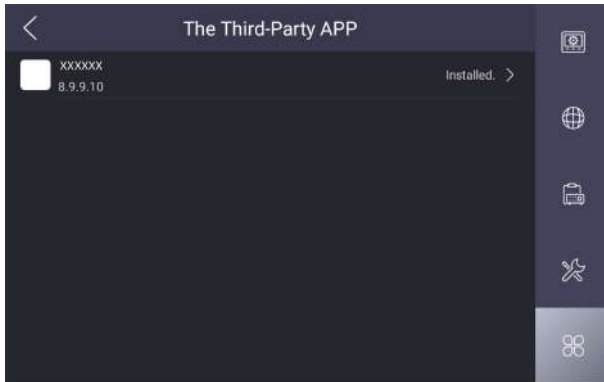

**Figure 4-4 Add the Third-Party Apps**

4. Tap **New APP** to view the details.
5. **Optional:** Tap the added third-party app, and tap **Clear Memory** to clear the app's memory or **Uninstall** the app.

### 4.3.2 Uninstall the App

#### Steps

1. Tap **Configuration** →  → **Configuration**
2. Enter the configuration password.

---

 **Note**

By default, the configuration password is the activation password.

---

3. Tap  to view the third-party apps.
4. Select an App and tap **Uninstall Application**.

---

 **Note**

You can also uninstall the Apps via client software remotely.

---

## 4.4 Information Management

You can view the received alarm logs, captured pictures, recorded videos, and recorded audios.

Take viewing alarm logs as an example. Tap **Message** →  and you can view all received alarm logs.

Hold one of the logs to clear all logs or delete the selected log.

---

 **Note**

Up to 200 alarm logs, 200 captured pictures, 200 recorded videos, 200 recorded audios can be viewed.

---

## 5 Remote Operation via the client software

The Video Intercom module provides remote control and configuration on video intercom products via the iVMS-4200 client software.

### 5.1 View Live Video of Door Station and Outer Door Station

You can get the live view of the door station and outer door station in the Main View module and control the door station and outer door station remotely.

In the Main View module, double-click a door station or outer door station device or drag the device to a display window to start the live view.

You can click **Unlock** on the menu to open the door remotely.

### 5.2 View Call Logs

You can check all the call logs, including dialed call logs, received call logs and missed call logs. You can also directly dial via the log list and clear the logs.

#### Steps

1. On the main page, click **Access Control → Video Intercom** to enter the Video Intercom page.
2. Click the Call Log tab to enter the Call Log page. All the call logs will display on this page and you can check the log information, e.g., call status, start time, resident's organization and name, device name and ring or speaking duration.

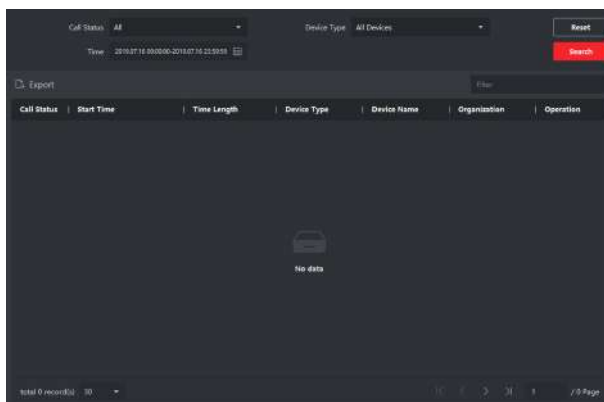

**Figure 5-1 Call Log**

3. **Optional:** Click the icon  in the Operation column to re-dial the resident.

## 5.3 Release Notice

You can create different types of notices and send them to the residents. Four notice types are available, including Advertising, Property, Alarm and Notice Information.

### Steps

1. On the main page, click **Access Control** → **Video Intercom** to enter the Video Intercom page.
2. Click **Notice** to enter the Release Notice page.

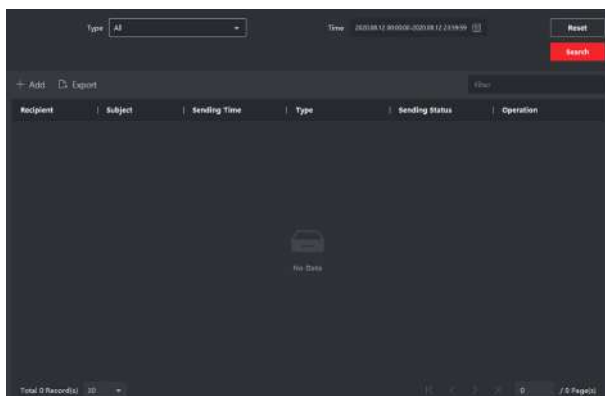

**Figure 5-2 Release Notice**

3. Click **Add** on the left panel to create a new notice.

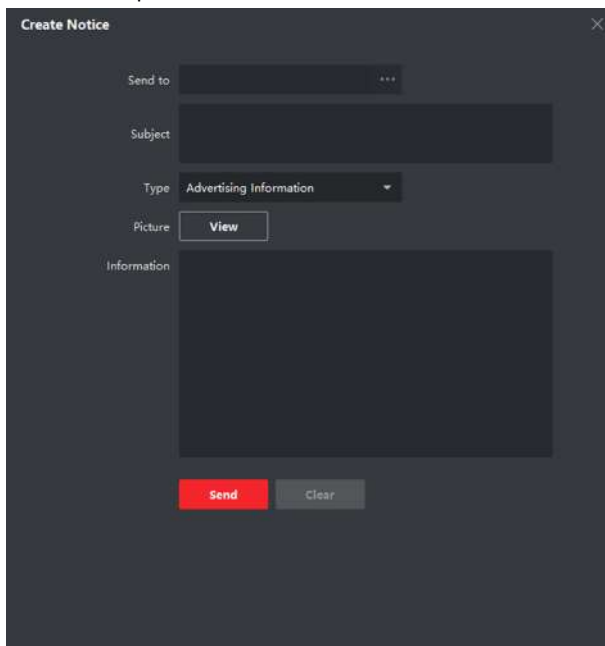

**Figure 5-3 Create a Notice**

4. Edit the notice on the right panel.

- 1) Click ... on the Send To field to pop up the Select Resident dialog.
- 2) Check the checkbox(es) to select the resident(s). Or you can check the **All** checkbox to select all the added residents.
- 3) Click **OK** to save the selection.
- 4) Enter the subject on the Subject field.

---

 **Note**

Up to 63 characters are allowed in the Subject field.

---

- 5) Click ▾ in the Type field to unfold the drop-down list and select the notice type.
- 6) **Optional:** Click **View** to add a local picture to the notice.

---

 **Note**

Up to 6 pictures in the JPGE format can be added to one notice. And the maximum size of one picture is 512KB.

---

- 7) Enter the notice content in the Information field.
- 8) **Optional:** You can also click **Clear** to clear the edited content.

---

 **Note**

Up to 1023 characters are allowed in the Content field.

---

5. Click **Send** to send the edited notice to the selected resident(s). The sent notice information will display on the left panel. You can click a notice to view the details on the right panel.

## 5.4 Search Video Intercom Information

You can search the call logs between the iVMS-4200 client software and video intercom devices, device unlocking logs and the sent notice information.

On the main page, click **Access Control** to enter the access control module.

In the Access Control module, click **Video Intercom** to enter the Video Intercom page.

### 5.4.1 Search Call Logs

**Steps**

1. On the main page, click **Access Control** → **Video Intercom** to enter the Video Intercom page.
2. Click **Call Log** to enter the Call Log page.

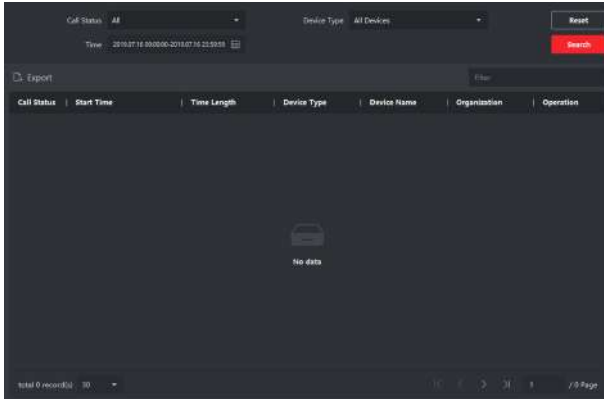

**Figure 5-4 Search Call Logs**

3. Set the search conditions, including call status, device type, start time and end time.

**Call Status**

Click  to unfold the drop-down list and select the call status as **Dialed**, **Received** or **Missed**. Or select **All** to search logs with all statuses.

**Device Type**

Click  to unfold the drop-down list and select the device type as **Indoor Station**, **Door Station**, **Outer Door Station** or **Analog Indoor Station**. Or select **All Devices** to search logs with all device types.

**Start Time/End Time**

Click  to specify the start time and end time of a time period to search the logs.

4. **Optional:** You can click **Reset** to reset all the configured search conditions.
5. Click **Search** and all the matched call logs will display on this page.

- Check the detailed information of searched call logs, such as call status, ring/ speaking duration, device name, resident organization, etc.
- Input keywords in the Search field to filter the desired log.
- Click **Export** to export the call logs to your PC.

### 5.4.2 Search Notice

#### Steps

1. On the main page, click **Access Control** → **Video Intercom** to enter the Video Intercom page.
2. Click **Notice** to enter the Notice page.

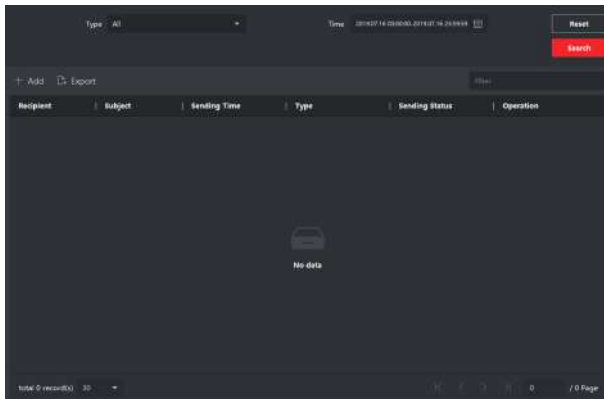

Figure 5-5 Search Notice

3. Set the search conditions, including notice type, subject, recipient, start time and end time.

#### Recipient

Input the recipient information in the Recipient field to search the specified notice.

#### Subject

Input the keywords in the Subject field to search the matched notice.

#### Type

Click  to unfold the drop-down list and select the notice type as **Advertising Information, Property Information, Alarm Information or Notice Information**. Or select **All** to search notices with all types.

4. **Optional:** You can click **Reset** to reset all the configured search conditions.
5. Click **Search** and all the matched notices will display on this page.
  - Check the detailed information of searched notices, such as sending time, sending status, etc.
  - Input keywords in the Search field to filter the searching result.
6. You can view and edit the notice details, check the sending failed/sent succeeded/unread users, and resend the notice to sending failed/unread users.
7. **Optional:** Click **Export** to export the notices to your PC.

# A. Communication Matrix and Device Command

## Communication Matrix

Scan the following QR code to get the device communication matrix.

Note that the matrix contains all communication ports of Hikvision access control and video intercom devices.



Figure A-1 QR Code of Communication Matrix

## Device Command

Scan the following QR code to get the device common serial port commands.

Note that the command list contains all commonly used serial ports commands for all Hikvision access control and video intercom devices.



Figure A-2 Device Command

