

# Incara™ Disq 80

Cat. No(s): 6 547 01/02/03/04/05/07/08 - 6 547 01F/02F/03F/04F/05F/07F/08F  
 6 547 10/11/12/13/14/15/16 - 6 547 10F/11F F/14F/15F/16F - 6 547 99 -  
 6 549 41/42/43/44/45/46/47/48/49/50/51/52/53/54/55 - 6 549 86/87/88/89

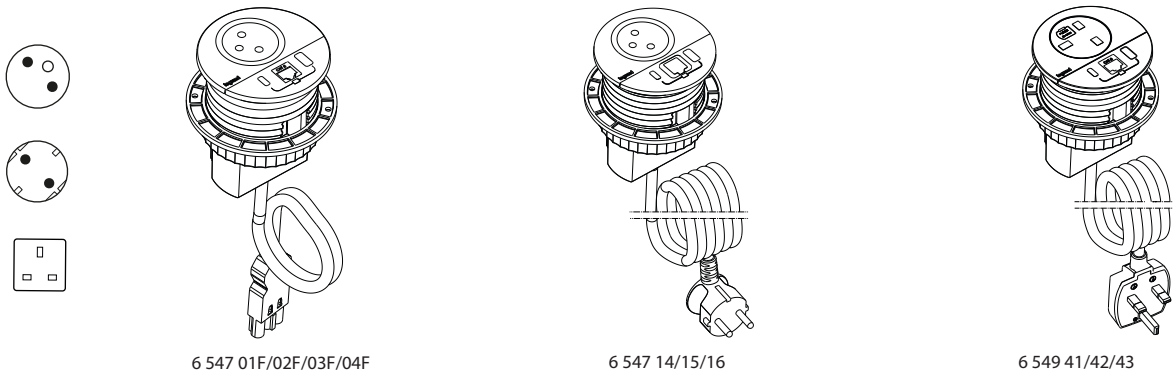

## 1. USE

Ideal solution for the nomad worker, Incara™ Disq 80 provides 3 functions in an 80mm integration diameter: power socket, USB A+C 15W, RJ 45 or cable exit for quick and ergonomic connection of mobile devices. Incara™ Disq 80 is available in 3 finishes: white, black, metal or with a metal sliding cover.

## 2. RANGE

### ■ 2.1 French & Schuko standards

Incara™ Disq 80 equipped with			Standards	2 m cord with 2P+E plug				0,5 m cord with Wieland® GST18i3 plug			
				White*	Black*	Metal*	Metal cover	White*	Black*	Metal*	Metal coverl
1x 2P+E	1 USB A+C	1 RJ45 CAT6 FTP	French	6 547 01	6 547 02	6 547 03	6 547 04	6 547 01F	6 547 02F	6 547 03F	6 547 04F
		1 cable exit		6 547 05	6 547 07	6 547 08	-	6 547 05F	6 547 07F	6 547 08F	-
	1 RJ45 CAT6 UTP	Schuko	6 547 10	6 547 11	6 547 12	6 547 13	6 547 10F	6 547 11F	6 547 12F	6 547 13F	
			1 cable exit	6 547 14	6 547 15	6 547 16	-	6 547 14F	6 547 15F	6 547 16F	-

\* Ring finishes (4 additionnal colours available on demand)

### ■ 2.2 British standard

Incara™ Disq 80 equipped with			Standards	2 m cord with Intersoc R plug			2 m cord with plug BS1363			0,5 m cord withWieland® plug GST18i3		
				White*	Black*	Metal*	White*	Black*	Metal*	White*	Black*	Metal*
1x 2P+E	1 USB A+C	1 RJ45 CAT6 UTP	British	6 549 44	6 549 45	6 549 46	6 549 41	6 549 42	6 549 43	6 549 50	6 549 51	6 549 52
		1 cable exit		6 549 47	6 549 48	6 549 49	-	-	-	6 549 53	6 549 54	6 549 55

\* Ring finishes (4 additionnal colours available on demand)

RJ45 = rear plug (female/female)

### 3. DIMENSIONS

#### ■ 3.1 Incara™ Disq 80 with RJ 45

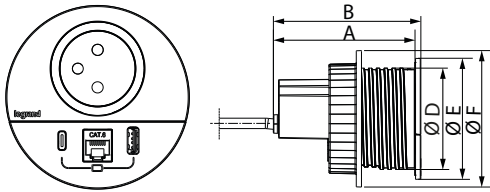

Cat. nos	A	B	-	D	E	F
<b>6 547</b> 01/02/03/01F/02F/03F 10/11/12/10F/11F/12F	109	113	-	78	93	105
<b>6 549</b> 41/42/43/44/45/46 50/51/52						

#### ■ 3.2 Incara™ Disq 80 with cable exit

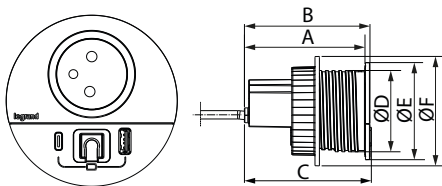

Cat. nos	A	B	C	D	E	F
<b>6 547</b> 05/07/08/05F/07F/08F 14/15/16/14F/15F/16F	109	113	115	78	93	105
<b>6 549</b> 47/48/49 53/54/55						

#### ■ 3.3 Incara™ Disq 80 with cover

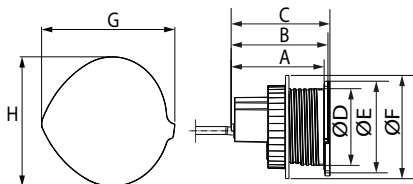

Cat. nos	A	B	C	D	E	F	G	H
<b>6 547</b> 04/04F 13/13F	109	113	116	78	93	105	114	96

### 4. INSTALLATION

Must not be fitted on the floor.

#### ■ 4.1 Into the desk

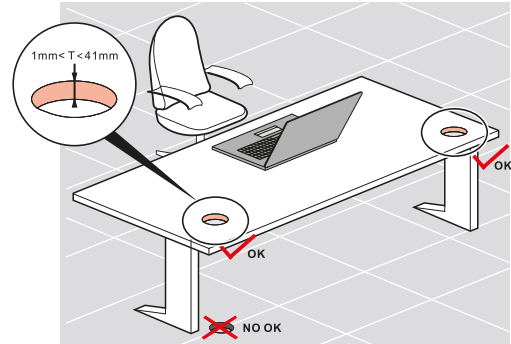

#### 4.1.1 Drilling dimensions and positioning

##### 4.1.1.1 for cat. nos without cover:

**6 547** 01/02/03/01F/02F/03F/10/11/12/10F/11F/12F  
**6 549** 41/42/43/44/45/46/50/51/52

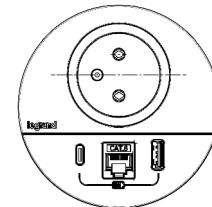
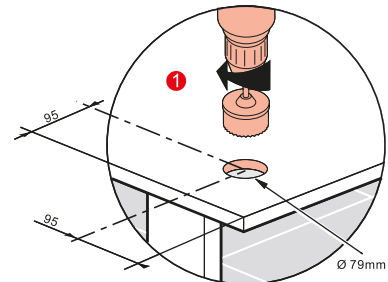

##### 4.1.1.2 for cat. nos with cover:

**6 547** 04/04F/13/13F

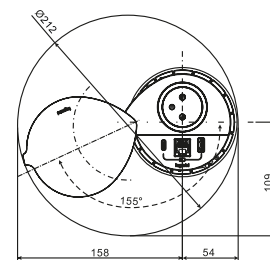
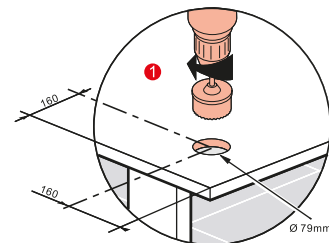

#### 4. INSTALLATION (cont.)

##### 4.1.2 Insertion

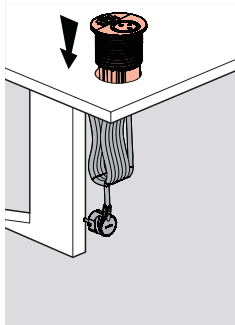

#### 5. TECHNICAL CHARACTERISTICS

##### ■ 5.1 Mechanical characteristics

Resistance to impact: IK 07

##### ■ 5.2 Material characteristics

Metal ring & cover: brushed aluminum + varnish

Black & white plastic ring & housing: Polycarbonate UL94V0

##### ■ 5.3 Electrical characteristics

###### 5.3.1. 2 P+E sockets characteristics

- Supply voltage: 250V~

- Frequency: 50/60 Hz

- Rated current:

. for French & Schuko standards = 16A

. for British standard : individually fused = 5A

###### 5.3.2 Rear plug RJ45 characteristics compliant to:

PoE+ pour Cat.6 UTP & FTP

PoE++ pour Cat. 6A FTP

###### 5.3.3 USB charger characteristics (LXX17)

Trade mark	
Address	128, av. du Maréchal-de-Lattre-de-Tassigny - 87045 LIMOGES Cedex Tel.: 0 (+33) 5 55 06 87 87 Fax: 0 (+33) 5 55 06 88 88 www.legrand.com
Input voltage	100-240V
Input AC frequency	50-60Hz
Output voltage	5,0V
Output current	3,0A
Output power	15,0W
Average active efficiency	82,0%
Efficiency at low load (10%)	80,0%
No-load power consumption	0,06W

###### 5.3.4 Cords characteristics

H05VV-F 3G 1.5mm<sup>2</sup>

##### ■ 5.4 Climate characteristics

Operating temperature: from -5°C to +35°C

Storage temperature: from -10°C to +70°C

#### 6. CLEANING

Superficial cleaning with a soft cloth. Do not use abrasive products or detergents

**Caution:** Always test before using other special cleaning products

#### 7. STANDARDS & APPROVALS

Compliant to:

		Standards	
French	Schuko	British	
		socket	complete product
NF C61-314 and IEC 60884-1	IEC 60884-1	BS 1363-2	BS 5733

USB charger compliant to IEC 62368-1

Products should be installed by competent persons to the current version of the local wiring regulations.

Please consult Legrand locally for further details.

#### 8. ACCESSORIES

##### ■ 8.1 Extension cords cat. nos 6 549 86/87/88/89

Cat. nos	Wieland GT18i3 cord		Cord characteristics
6 549 86	2 P+E plug	2 m	H05VV-F 3G1.5mm <sup>2</sup>
6 549 87		3 m	
6 549 88	BS plug	2 m	
6 549 89		3 m	

##### ■ 8.2 Protective case for Wieland® GST18i3 connector cat. no 6 547 99

for cat. nos 6 547 01F/02F/03F/05F/07F/08F/10F/11F/12F/14F/15F/16F

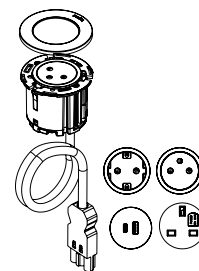

Protective case allowing compliance with NFC 61-314 standard, which requires an housing covering the installation couplers. Access for connection or disconnection of these couplers must be possible only using a tool (e.g. screwdriver)

