

Valena™ Allure Connected switch without neutral with dimmer option

Cat. No(s): 7 525 84 - 7 526 84 - 7 527 84 - 7 528 84 - 7 529 84

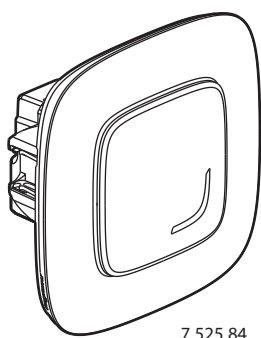

7 525 84

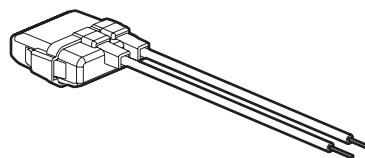

0 401 49

1. USE

Connected switch without neutral with dimmer option, configured by default as ON/OFF.

Can be combined with one or more wireless lighting controls (dimmer mode can be activated from the Home + Control app).

For local or remote control of your lighting.

Supplied with an active power compensator (Cat. No. 0 401 49), mandatory to ensure optimum operation with commercially-available lamps.

One compensator per lighting circuit is sufficient.

Easy to install in place of a standard switch in a box 40 mm deep (minimum).

Claw and/or screw fixing.

2. RANGE

Description	White	Ivory	Aluminium	Black	Pearl
Product for use in conjunction with the starter pack. With LED indicator (configuration) and RESET button (hidden) used to return to factory settings. Supplied complete with claws and site protection cover.	7 525 84	7 526 84	7 527 84	7 528 84	7 529 84

3. DIMENSIONS (mm)

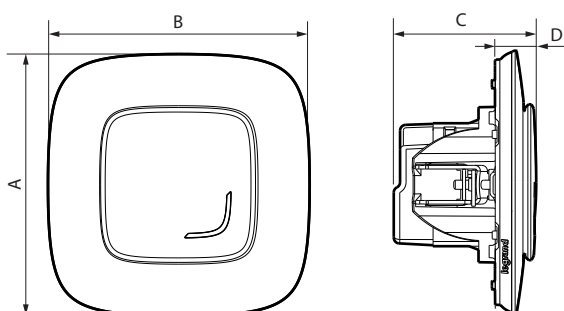

A	B	C	D
90	90	46	13

4. CONNEXION

Type de bornes : à vis

Capacité des bornes : 2 x 1,5 mm² ou 1 x 2,5 mm²

Longueur de dénudage : 8 mm

Tournevis plat : 3 mm

5. OPERATION

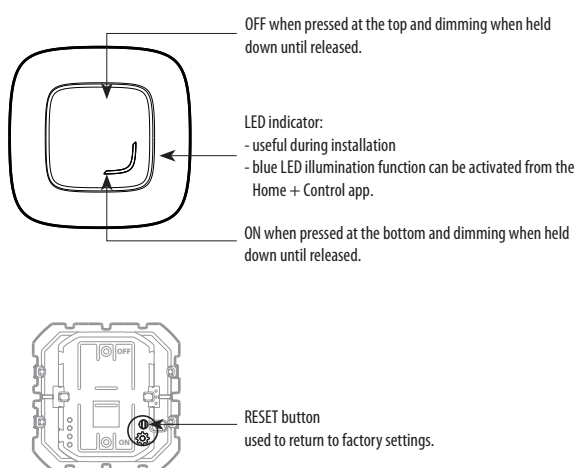

Valena™ Allure

Connected switch without neutral with dimmer option

Cat. No(s): 7 525 84 - 7 526 84 - 7 527 84 - 7 528 84 - 7 529 84

6. TECHNICAL CHARACTERISTICS

■ 6.1 Mechanical characteristics

Protection against impacts: IK 04

Protection against solid bodies/liquids: IP 41 assembled product

■ 6.2 Material characteristics

Plate: ABS

Sub-plate: PC

Rocker plate: ABS

Colours: White RAL 9003

Ivory RAL 1013

Mechanism casing: PC

Support: PC grey RAL 7016 + metal

Halogen-free

UV-resistant

Self-extinguishing:

850°C/30 s for insulating parts holding live parts in place.

650°C/30 s for the other insulating components.











■ 6.3 Electrical characteristics

Voltage: 110-230 V~

Power: 300 W

Frequency: 50/60 Hz

Standby consumption: < 0.2 W

		R	L			
			LED 			
						
240 V~	Max.	300 W	^(*) 50 W	50 W	300 VA	300 VA
	Min.	7 W	5 W	9 W	10 VA	35 VA
100 V~	Max.	150 W	^(*) 25 W	25 W	150 VA	150 VA
	Min.	7 W	5 W	9 W	10 VA	35 VA

^(*) Or 5 lamps max. For comfortable lighting, we recommend using bulbs of the same type and make.

^(**) The ferromagnetic transformers must be charged to more than 60% of their power. When calculating the permissible power, the ferromagnetic transformer efficiency must be taken into account. A load must be connected before programming and using the product.

Zigbee technology 2.4 GHz to 2.4835 GHz

Power level: < 100 mW

Range: 200 m of unobstructed space

10 m between products indoors

■ 6.4 Climate characteristics

Storage temperature: 0°C to + 45°C

Usage temperature: + 5°C to + 45°C

7. CARE

Clean the surface with a cloth.

Do not use acetone, tar-removing cleaning agents or trichloroethylene.

Resistant to the following products:

Hexane (EN 60669-1), methylated spirit, soapy water, diluted ammonia, pure bleach diluted to 10%, window-cleaning products, pre-impregnated wipes.

Caution: Always test before using special cleaning products.

The plates must not be painted.

8. STANDARDS AND APPROVALS

Compliant with installation and manufacturing standards.

See e-catalogue.

The undersigned, LEGRAND, declares that the radio-electric equipment type (7 525 84 - 7 526 84 - 7 527 84 - 7 528 84 - 7 529 84) complies with directive 2014/53/EU.

The full text of the EU declaration of conformity is available on the following website: www.legrandoc.com