

Energy meter on CT/1A - /5A, indirect connection

Codes: CE4TBDTCL1 – CE4TB0PCL1 – CE4TBMTCCL1
 Model: CONTO D4-Pt



Contents	Pages
1. Use	1
2. Range	1
3. Installation	1
4. Dimensions	1
5. Connections	2
6. Operating data	3
7. General features	4
8. Conformity and certifications	7
9. Communication	8

1. USE

Bidirectional active and reactive energy meter (4 quadrants). Indirect connection through /1A - /5A ratio current transformers. The device, 4 DIN modules, is self-powered and has ModBus or Mbus communication or pulse output and double tariff input. On the menu it is possible to select the device configuration for operation with the different types of connections (3N3E;3-3E;3-2E).

2. RANGE

Code Art.	In	Output	Input	Range Voltage
CE4TB0PCL1	1/5A	Pulse	Pulse	3x100V 3x230V 3x400V ± 15%
CE4TBDTCL1	1/5A	ModBus	2 Tariff	3x100V 3x230V 3x400V ± 15%
CE4TBMTCCL1	1/5A	MBus	2 Tariff	3x100V 3x230V 3x400V ± 15%

3. INSTALLATION

Fixing:

On EN/IEC 60715 symmetric rail or DIN 35 rail.

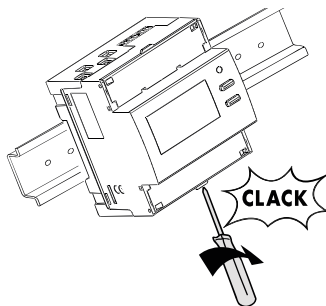

Necessary tools:

For fastening the device on the DIN rail: 5.5 mm flat screwdriver (from 4 to 6 mm).

Operating position:

Vertical, Horizontal, Upside down, On the side



4. DIMENSIONS

Housing: 4 DIN43880 modules

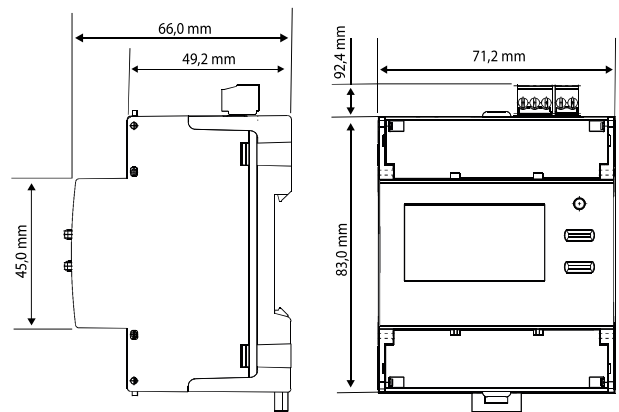

Energy meter on CT/1A - /5A, indirect connection

Codes: CE4TBDTCL1 – CE4TB0PCL1 – CE4TBMTCCL1
Model: CONTO D4-Pt

5. CONNECTIONS

Terminal board marking and diagram combination:

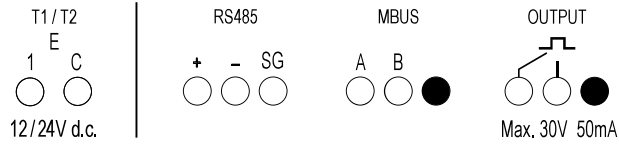

Wiring diagrams:

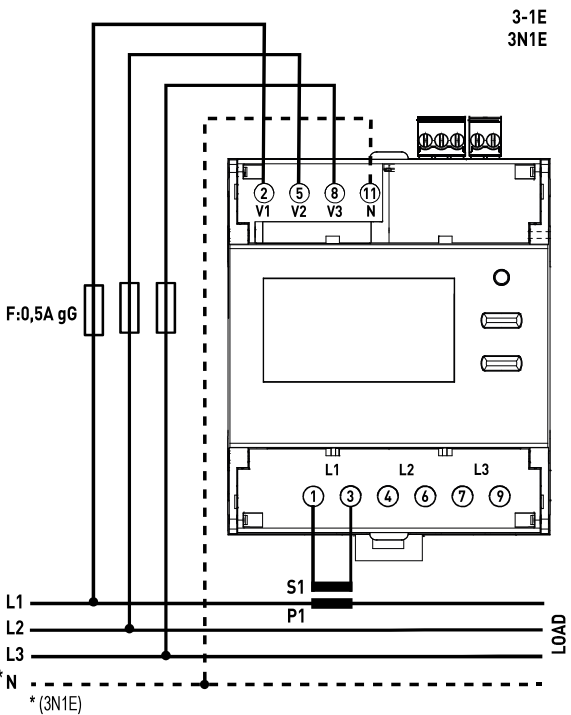
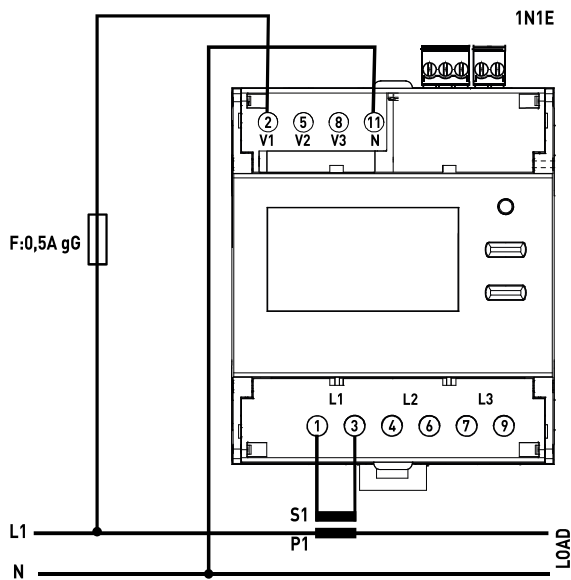

5. CONNECTIONS (continues)

Wiring diagrams:

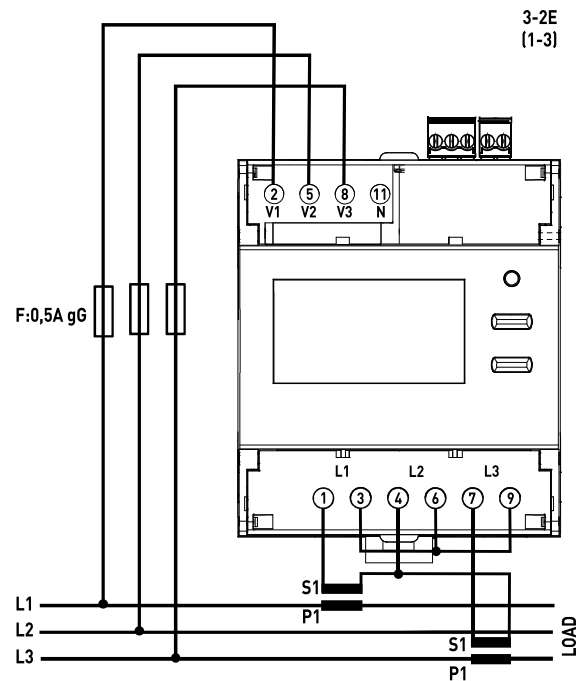
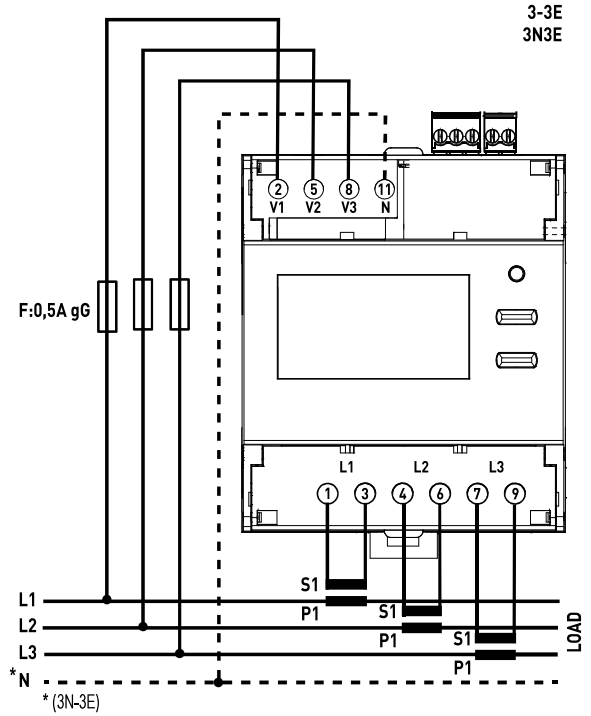

Energy meter on CT/1A - /5A, indirect connection

Codes: CE4TBDTCL1 – CE4TB0PCL1 – CE4TBMTC1
Model: CONTO D4-Pt

5. CONNECTIONS

Wiring diagrams:

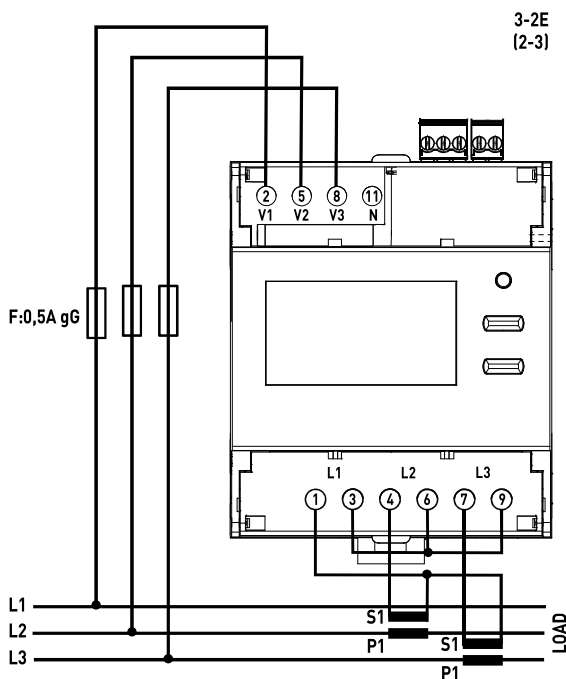
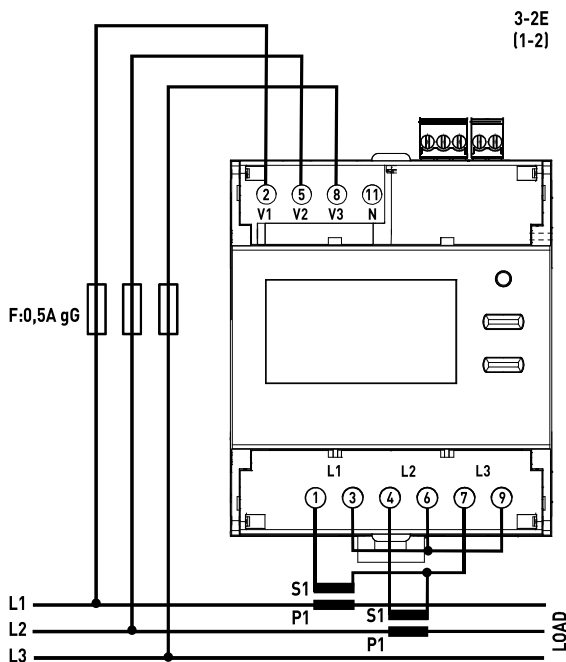

5. CONNECTIONS

Connection on VT:

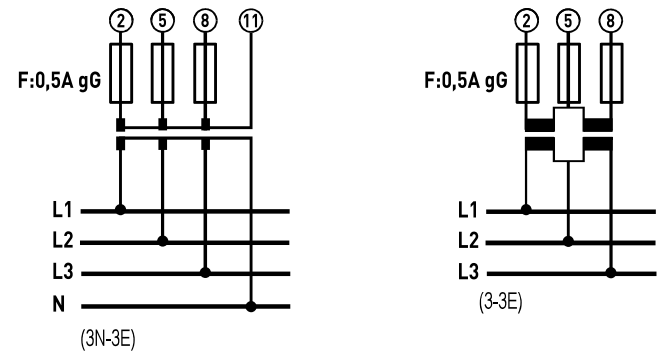

6. OPERATING DATA (continues)

6.1 ELECTRIC DATA

Currents:

- Minimum measurement current: 0,05-5(6)A / 0,01-1(1,2)A
- Starting current, I_{st} : 10mA

Rated voltages:

- Three-phase rated voltage U_n :
3x100...3x400V, 3x100/173...3x230/400V $\pm 15\%$

Rated frequency:

- F_n : 50Hz; 60Hz
- Permitted variation: 49...51Hz; 59...61Hz

Connectable section:

- Copper wires
- Voltage connection terminals (V1, V2, V3, N)
- Current connection terminals (L1, L2, L3)

	Without bush	With bush
Rigid wire	1 x 0,75 + 16 mm ²	-
Flexible wire	1 x 0,75 + 16 mm ² (\varnothing 5mm)	1 x 4 + 10 mm ²

- Terminal boards in the upper part of the meter (input, impulse output and bus):

	Without bush	With bush
Rigid wire	1 x 0,2 + 1,5 mm ²	-
Flexible wire	1 x 0,2 + 1 mm ²	1 x 0,2 + 1 mm ²

Utensili necessari:

- For all measuring terminals: screwdriver with 6mm blade or Pozidriv No. 2
- For the terminal boards in the upper part of the meter (input, impulse output and bus): screws with 2.5mm blade

Energy meter on CT/1A - /5A, indirect connection

Codes: CE4TBDTCL1 – CE4TB0PCL1 – CE4TBMTCCL1
Model: CONTO D4-Pt

6.2 MECHANICAL DATA

Screw terminals:

- Depth of the terminals: 12mm
- Lengths of the wire stripping: 11mm

Screw head:

- Voltage (V1, V2, V3, N) and current (L1, L2, L3) connection terminals: screws with countersunk head with hexagon socket and Pozidriv No. 2
- Terminal boards in the upper part of the meter (input, impulse output and bus) screws with countersunk head with hexagon socket

Recommended torque:

- Voltage connection terminals (V1, V2, V3, N): from 1.6Nm to 2Nm
- Current connection terminals (L1, L2, L3): from 1.6Nm to 2Nm
- Terminal boards in the upper part of the meter (input, impulse output and bus): 0.2 N/m

Terminal protection:

- The power terminals are protected with sliding and sealable terminal front covers which are integrated in the device

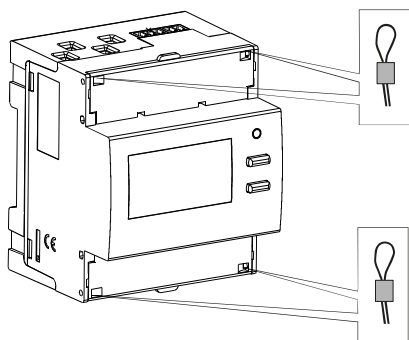

7. GENERAL FEATURES (continues)

Marking data:

Indelible marking

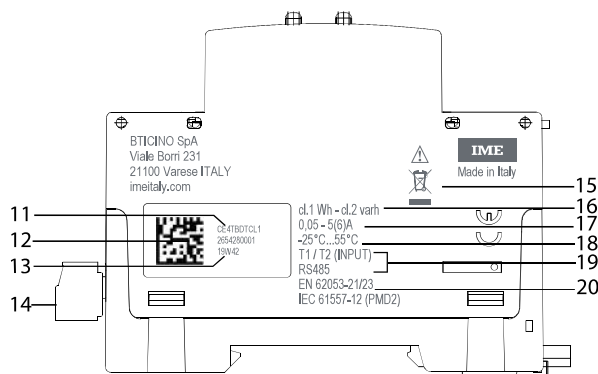
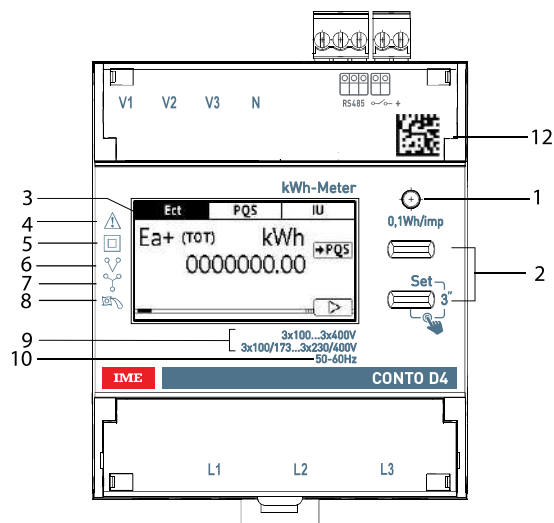

1. Metrological LED
2. Keypad made up of 2 double-function pushbuttons (display/configurations)
3. Graphic display
4. Consult the user manual before installation
5. Double insulation
6. Connection on 3-wire three-phase line
7. Connection on 4-wire three-phase line
8. Anti-rotation device (anti-decreasing)
9. Voltage
10. Frequency
11. Product code
12. Datamatrix for product traceability
13. Week and year of manufacture
14. Output connection terminals
15. RAEE Symbol
16. Precision class
17. Correnti Current
18. Temperature of use
19. Outputs
20. Standard

Energy meter on CT/1A - /5A, indirect connection

Codes: CE4TBDTCL1 – CE4TB0PCL1 – CE4TBMTCCL1
 Model: CONTO D4-Pt

7. GENERAL FEATURES

Laser marking

Left side
Traceability information

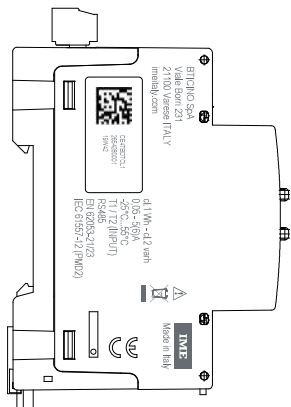

Right side
Wiring diagram

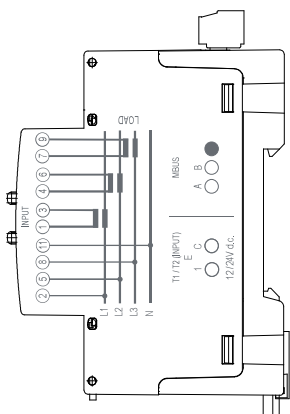
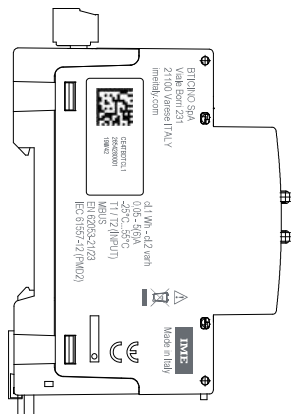
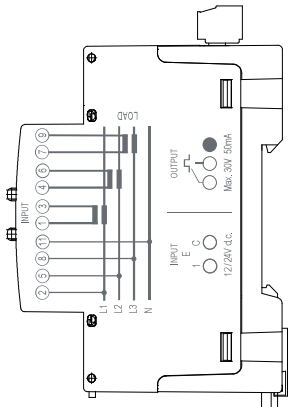
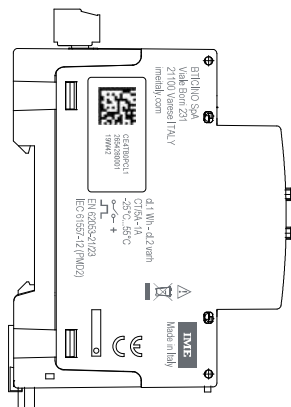
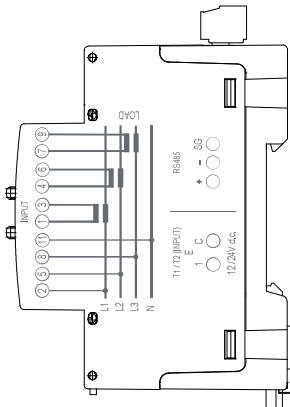

7. GENERAL FEATURES (continues)

Display:

- Graphic, backlit, 1.8 inches (256x128).

Resolution:

- Total meters: 0,01kWh/kvarh
- Partial meters: 0,01kWh/kvarh
- Tariff meters: 0,01kWh/kvarh
- CT Ratio: 1...9999
- VT Ratio: 1,0...300,00

Maximum indication

- Total meters: 9 999 999,99
- Partial meters: 9 999 999,99
- Tariff meters: 9 999 999,99

Metrological LED: 0,1Wh/imp.

Display of the value and programming:

- By means of the front keypad, 2 pushbuttons.
- Change protected by identification code (**predefined code 1000**); the code can be changed during the programming procedure.

Measurements and precision:

Conformity with EN/IEC 62053-21

- Active Energy cl.1

Conformity with EN/IEC 62053-23

- Reactive Energy cl.2

Conformity with EN/IEC 61557-12

- Current: cl.0,5
- Voltage: cl.0,5
- Frequency: $\pm 0,1$ Hz
- Instantaneous total active power, phase, average value and max. average value cl.1
- Instantaneous total active power, phase, average value and max. average value: cl.1
- Instantaneous total reactive power, phase: cl.2
- Instantaneous total apparent power, phase: cl.1
- Power Factor: cl.1

Average power:

- Measurement: active power
- Calculation: moving average, on the selected period
- Average time: 5/8/10/15/20/30/60 min.

Hour meter:

- Counting of operating hours and minutes (**resettable meter**)
- Resolution: 7 figures (5 for the hours + 2 for the minutes)
- Maximum display: 99 999.59 (tariff total)
- Programmable value: 0...50% Pn (positive)

Energy meter on CT/1A - /5A, indirect connection

Codes: CE4TBDTCL1 – CE4TB0PCL1 – CE4TBMTCCL1

Model: CONTO D4-Pt

7. GENERAL FEATURES

Digital input

- The digital input allows switching the energy counting on 2 tariffs
- 2 input terminals with common point (1 - C)
- Rated voltage: 12 – 24V d.c. max. 10mA

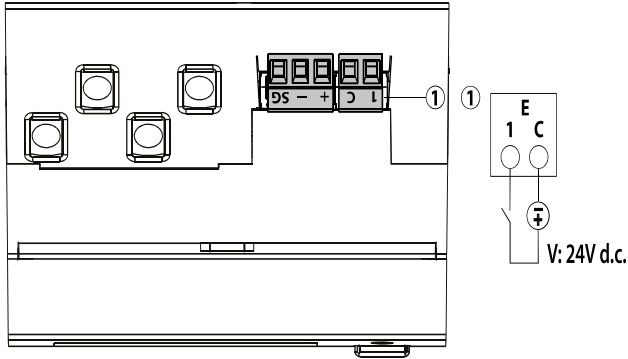

Features of the ModBus communication port:

- Programmable addresses: from 1 to 255 (5*)
- Communication speed: 4.8 – 9.6 – 19.2* – 38.4 kbps
- N°-bit: 8
- Parity bit: none, even*, odd
- Stop bit: 1
- Galvanically isolated with respect to the measurement inputs
- Standard RS485 3 wires, half-duplex
- Modbus® RTU protocol
- Response time (question/response time-out): ≤ 200ms
- 120Ω terminating resistor inside the instrument (it can be set in the SETUP menu, default value: none*)

Features of the MBus communication port:

- Standard: EN 13757
- Transmission: serial asynchronous
- No. of bit: 8
- Parity bit: fixed even
- Communication speed: 300-600-1.200-2.400*-4.800-9.600bit/s
- No. of primary address: 0*...250
- No. of secondary address: 0...99,999,999
- Load MBus: 1
- Galvanically isolated with respect to the measurement inputs
- Transferred measurements: see communication protocol

Features of the Impulse output:

- Optorelay with potential-free SPST-NO contact
- Type S0 (IEC/EN62053-31)
- Voltage Uimp: Max. 24V a.c./d.c.
- Current Iimp: Max. 50 mA
- Programmable impulse weight, possible values:
1 – 10* – 100 – 1k – 10k Wh/imp or varh/imp
- Programmable impulse duration, possible values:
50 -100* – 200 – 300 – 400 – 500msl

* Factory setting

7. GENERAL FEATURES

Auxiliary power supply:

- Shunted from the power socket (Self-supplied)

Operating room temperatures:

- Min. = - 25 °C Max. = + 55 °C

Room storage temperatures:

- Min. = - 25 °C Max. = + 70 °C
- Max.humidity. 85% non-condensing

Short-duration overcurrent:

- 20 I_{max} per 0,5sec

Short circuit current:

- Test not applicable to indirect meters.

Voltage circuit self-consumption:

- Max.1,5VA three-phase

Current circuit self-consumption:

- Max.1,8W for each phase

Maximum dissipated thermal power for the thermal dimensioning of the panels: ≤ 6W

Protection class:

- Terminal protection index against solid bodies and liquids: IP 20 (IEC/EN 60529).
- Housing protection index against solid bodies and liquids: IP 54 (IEC/EN 60529).

Protection of the device:

- By means of thermal-magnetic circuit breaker and 0.5A gG fuse

Room: mechanical M1 – electric E2

Housing material: Polycarbonate

Packaged volume: 0,60 dm³.

Wheight: 0,210Kg

8. CONFORMITY AND CERTIFICATIONS

Insulation

- Measurement categories: III
- Level of pollution: 2
- Insulation voltage, U_i : 300V, Phase-Neutral

Dielectric rigidity:

- Power supplies/ Outputs: 4kV / 50Hz / 1min
- Housing / Terminals: 4kV / 50Hz / 1min

Pulse:

- Power supplies: 6.3kV / 1.2 – 50 μ sec / 0.5J
- Power supplies/ Outputs: 6.3kV / 1.2- 50 μ s / 0.5J

In compliance with the standards:

- Precision class: Class 1 active energy (EN/IEC 62053-21)
- Precision class: Class 2 reactive energy (EN/IEC 62053-23)
- Electromagnetic compatibility: Tests in accordance with EN/IEC 62052-11
- Precision class according to IEC/EN61557-12

Respecting the environment – Conformity with the CEE directives:

- Compliance with the 2100/65/EU Directive, as modified by the 2015/863 Directive (RoHS 2), on the restriction of the use of certain hazardous substances in electrical and electronic equipment.
- Conformity with the REACH Regulation (1907/ 2006): at the date of publication of this document no substance in the annex XIV is found in these products.
- RAEE Directive (2012/19/EU): the sale of this product includes a contribution to the appointed environmental bodies of each European country in charge of handling, at the end of their life, the products falling within the scope of the EU Directive on Electric and Electronic Equipment Waste.

Plastic materials:

- Plastic materials without Halogens.
- Part marking according to standards ISO 11469 and ISO 1043.

Packaging:

- Packaging designed and produced in accordance with Decree 98-638 of 07.20.98 and directive 94/62/CE

9. COMMUNICATION

RS485 Modbus wiring diagram:

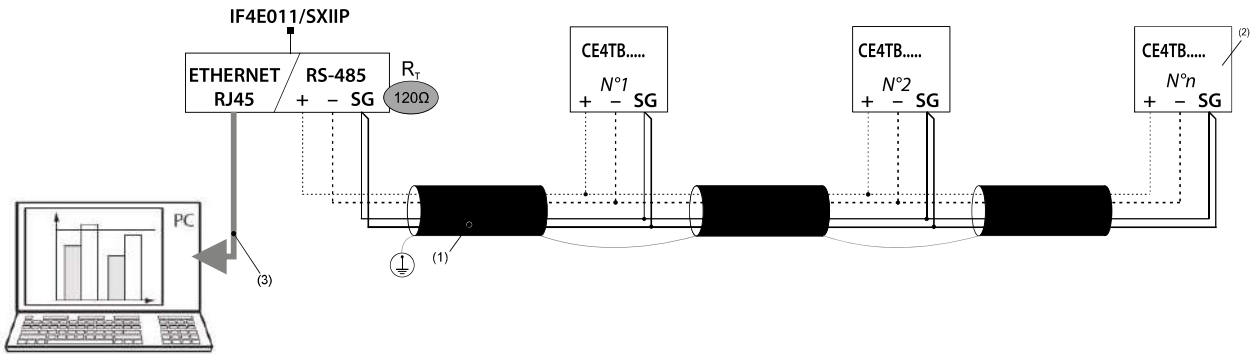

RS485 Modbus wiring diagram with Mini Web Server:

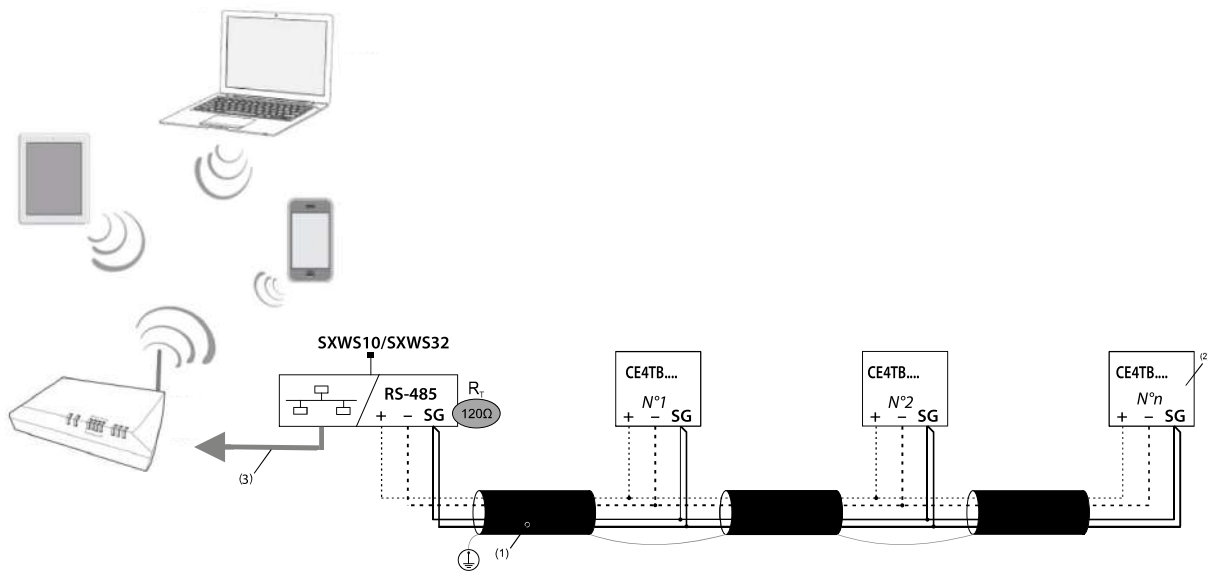

- (1) RS485: Required use of Belden 9842 or Belden 3106A wire (or equivalent) for a maximum bus length of 1000 m, or Category 6 wire (FTP or UTP) for a maximum length of 50 m
- (2) 120Ω terminating resistor inside the instrument (it can be set in the SETUP menu)
- (3) Ethernet: Cat. 6 (FTP/UTP)

Mbus wiring diagram:

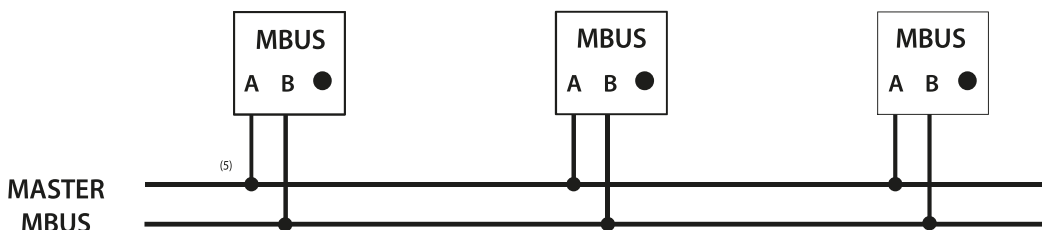

Non-polarized connections
(5) A two-wire standard telephone cable (JYStY N*2*0.8 mm)

Communication tables

- The MODBUS and MBUS communication protocols are available on the <http://www.imeitaly.com>