

Contents

Introduction	4
Technology Guide	
Presence & Absence Explained	6
Switching With LUX Level Sensing	7
Maintained Illuminance	8
UHS5 Compact Handset Programming	9
For models including '-PRM' and '-PRM-2CH'	9
For Dimming models including '-DD/SR' and '-AD'	10
UNLCDHS Universal Handset Programming	11
Programming Overview	12
Readback Function	12
Keypad Operation	13
Parameters	14
Channel Dimming and Switch Mode Explained	15
UNLCDHS Programming Basic Parameter Settings	19
Detector Parameter (Ch 1 & 2)	20
LUX Control (Ch 1 & 2)	21
User	22
UNLCDHS Programming Advanced Parameter Settings	23
Configuration	24
Output Ch 1	25
Output Ch 2	26
UNLCDHS Programming Advanced Parameter Settings For Dimming Controllable Units '-DD/SR' and '-AD' and Variants	27
Output Ch 2	28
User	30
Device Information	31

Introduction

Purpose of the Manual

This manual is to explain the programming of the CP Electronics Standalone sensors of the ranges below:

- EBDSPiR and their variants
- EBDSPiR-B and their variants
- EBDMR and their variants
- EBDsM and their variants
- EBDRC and their variants
- EBDHS and their variants
- EBDHS-MB and their variants
- EBMHS and their variants
- EMBPiR-MB and their variants
- EBMiNT and their variants
- EBMPiR and their variants
- MWS1A and their variants
- MWS3A and their variants
- MWS5 and their variants
- MWS6 and their variants
- MWSiNT and their variants

Applicable sensors are not limited to the above list of examples as newer product ranges may have been added since the production of this manual.

Note: Products of network connection nature are NOT covered in this manual and the appropriate manuals are referred to by their install instruction guides. For example sensors in the Vitesse Plus range ViTP7-EBDSPiR, ViTP7-MWS3A are covered by the Vitesse Plus System Manual.

For Rapid system sensors such as EBR-CPiR, EBR-EBDMR, kindly refer to the RAPiD System install manual for their use and support.

Programming Peripherals



The functionality of the sensors is controlled by a number of parameters which can be changed or programmed by any of the following devices:

- UHS5 Infrared Handset. See UHS5 section.
- UNLCDHS Infrared Handset (with LCD). See UNLCDHS section

For most basic programming operations, the small UHS5 handset will suffice whilst the UNLCDHS Universal LCD handset can be used for the programming of the advance functions.

Point the handset at the Sensor and send the required programming commands to the unit as shown.

Valid commands will be indicated by a red LED flash.

UHS5

Compact Handset Programming



Technology Guide

Presence & Absence Explained

Detection Mode

The Detection Mode for both output Channels 1 and 2 can be set to behave in Presence or Absence mode:

Presence

- When movement is detected the load will automatically turn on. When the area is no longer occupied the load will automatically switch off after an adjustable time period.

Absence

- The load is manually switched on. When the area is no longer occupied the load will automatically switch off after the adjustable time period has elapsed.

In either case, sensitivity to movement of the PIR sensor can be adjusted using the Sensitivity parameter.

HINT: To assist in setting the sensitivity, turn on the Walk Test LED which will flash red when movement is detected.

The choice between presence and absence detection for different spaces can make a big difference in user-friendliness and the amount of energy saved.

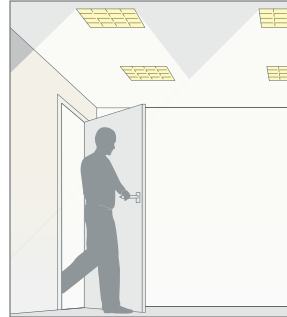

Presence Detection: Detectors will switch on lighting automatically when a person enters the room, and switches off lighting automatically when no movement is detected.

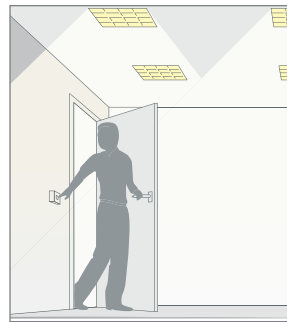

Absence Detection: Upon entering the room the person switches on the light as normal, but on leaving the detector switches off the lighting automatically. Lights can also be switched off manually.

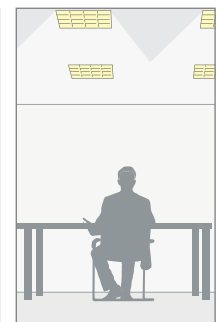
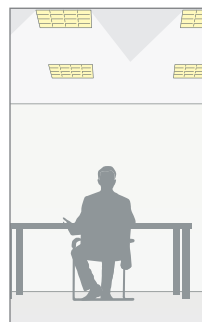

Absence Recovery: After an occupancy time out period has elapsed in absence mode, the unit temporarily enters a presence mode for 10 seconds allowing the occupants movement to bring the lights back on.

Manual Timeout

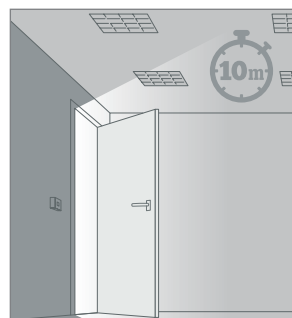
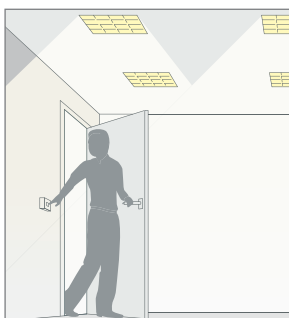

Manual Timeout (via switch): This ensures that if a switch is activated and no movement is detected the lights will switch off after 10 minutes, minimising unnecessary lit space.

Technology Guide

Switching With LUX Level Sensing

Switch Level On / Off

Occupancy detection can be made dependant on the ambient light level using the LUX On Level and LUX Off Level parameters.

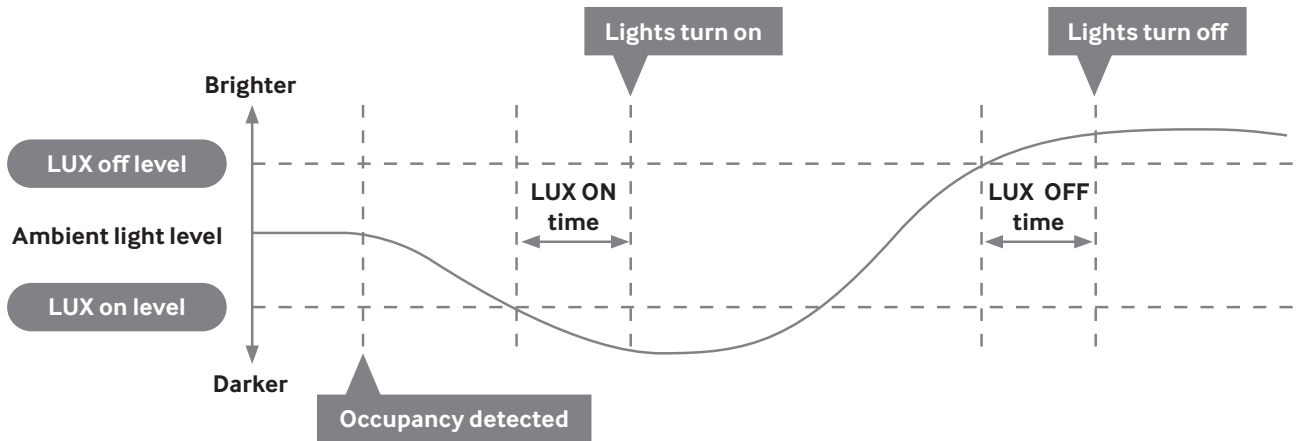

Kindly refer to the product manual of the specific model for the usable LUX range.

Switching with LUX level sensing

Most of our detectors have built-in adjustable LUX sensors which will keep the lighting switched off if there is sufficient natural light.

All ceiling mounted PRM detectors can be set up from ground level using our simple programming handsets. A LUX time delay can be set to avoid nuisance switching with constantly varying LUX levels.

LUX level sensing in 'presence detected' and 'no presence detected' scenarios

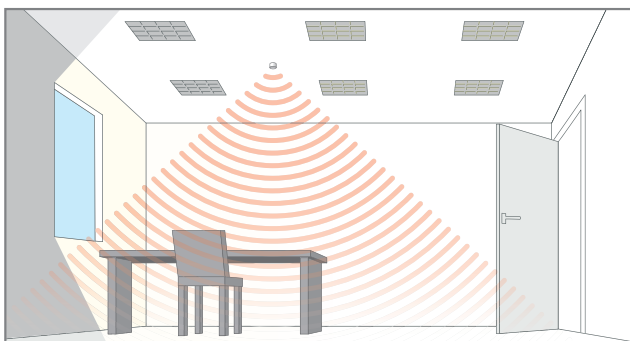

No presence detected, daylight, lights off.

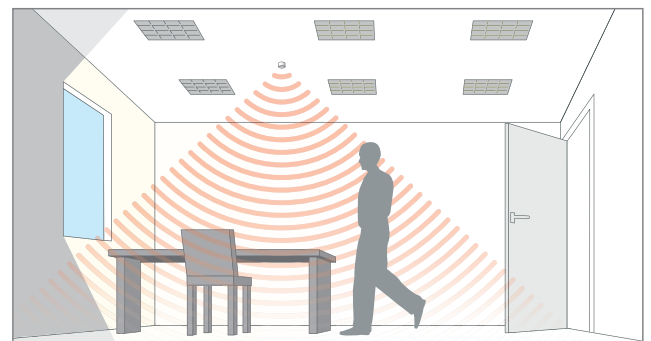

Presence detected, sufficient daylight, lights off.

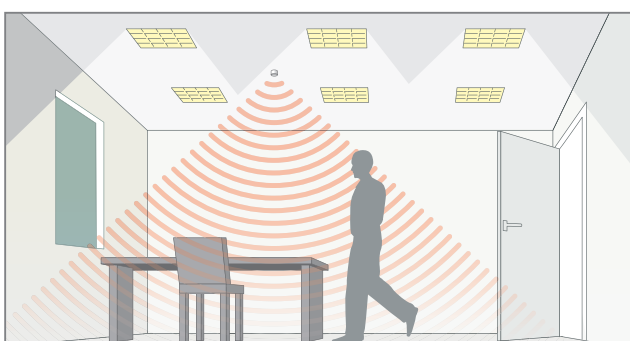

Presence detected, insufficient daylight, all lights on.

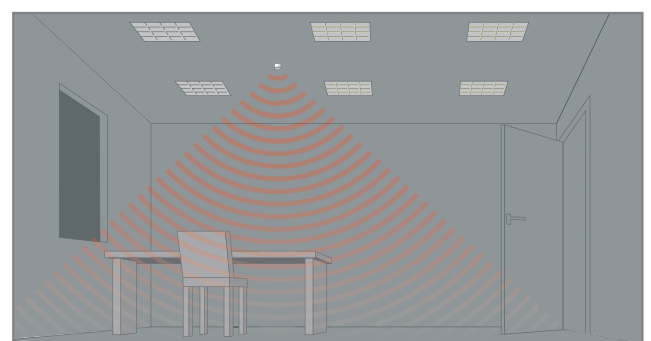

No presence detected, lights off.

Technology Guide

Maintained Illuminance

The detector measures the overall light level in the detection area and calculates the correct output for the luminaires, to maintain above the required minimum illuminance level (maintained illuminance).

A dimming detector can be used to control the light output of luminaires that are fitted with dimming drivers.

The detector measures the overall light level in the detection area and regulates the output of the luminaires, to maintain a minimum required level for the area and saving energy when natural daylight can be used to replace / supplement artificial lighting (daylight harvesting).

Maintained illuminance in 'presence detected' and 'no presence detected' scenarios

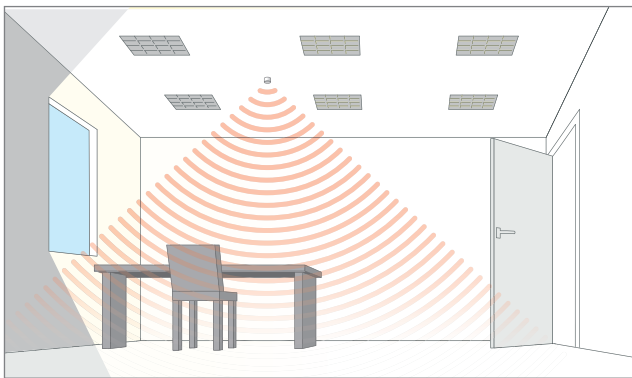

No presence detected, daylight, lights off.

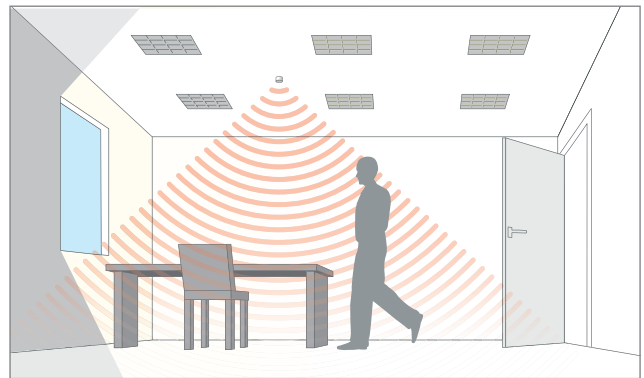

Presence detected, sufficient daylight, lights off.

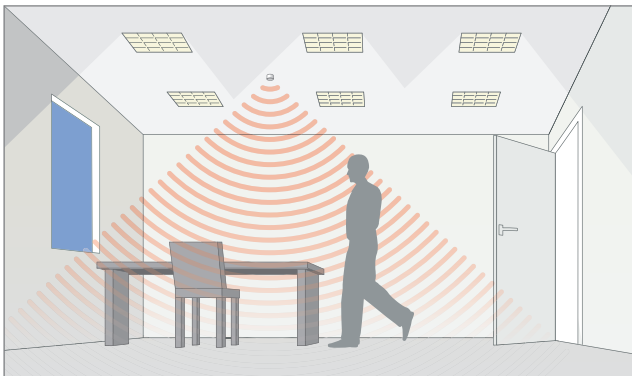

Presence detected, some daylight.
Lights on and dimmed to maintain a minimum level.

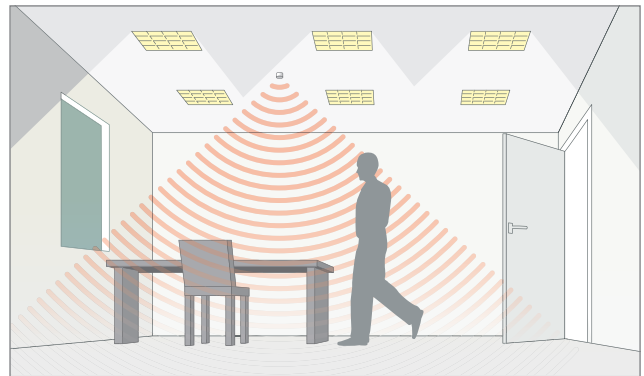

Presence detected, insufficient daylight.
Detector measures and implements maintained illuminance.

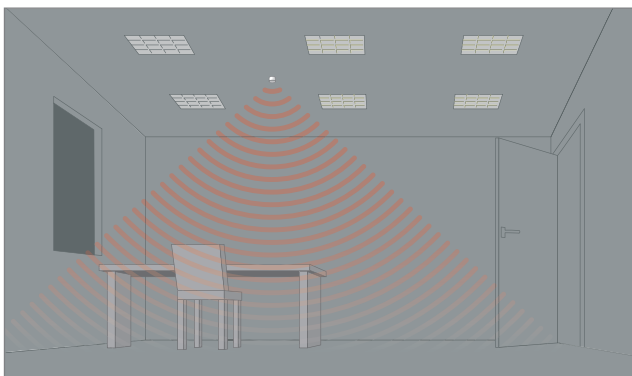

No presence detected, lights off.

UHS5 Programming

For all models including '-PRM' and '-PRM-2CH'



For most basic programming operations the UHS5 handset can be used and the following procedures are based on using this device. Independent channel control for '-PRM-2CH' is only partially supported and so it is advised to use the UNLCDHS handset instead.

Point the handset at the sensor and send the required programming commands to the unit as shown below. Valid commands will be indicated by a red LED flash. See page 1 for details of other LED responses.

Note: other functions on the UHS5 which are not shown below are not applicable to this product.

Parameter Name	Default Value	Number of shift presses				UHS5 Handset Graphics	Description
		0 SHIFT 1 SHIFT 2	1 SHIFT 1 SHIFT 2	2 SHIFT 1 SHIFT 2	3 SHIFT 1 SHIFT 2		
On		On		Cancel override on			Turn lights on
Off		Off		Cancel override off			Turn lights off
Walk test	Off	On	Off				When set to On this causes a red LED to flash on the sensor when it detects movement. Use this feature to check for adequate sensitivity levels.
Time Out (Time adjustment)	20 mins	1, 10 & 20 minutes	5, 15 & 30 minutes	10 seconds (5/1 button)			Once the detector is turned on, this value sets how long the lights will stay on once movement has ceased.
LUX on level (Switch level on)	9	2, 5 & 7	4, 6 & 9				LUX level setting to prevent the luminaires from being switched on if the ambient light level is sufficient (adjustable between 1 and 9). The luminaires will always be switched on at level 9.
LUX off level (Switch level off)	9	2, 5 & 7	4, 6 & 9				LUX level setting switches the luminaires off during occupancy if the ambient light level goes above the setting (adjustable between 1 and 9). Level 9 will always keep the lights on. This setting can be used for "window row switching". Note: the LUX Off Level value must always be greater than the LUX On Level value.
Sensitivity	9	1, 5 & 9	3, 6 & 8				Sensitivity level for detecting movement. 1 = low sensitivity 9 = high sensitivity
Defaults				D			Returns the unit to the default settings.
Presence / Absence	Presence	Presence	Absence				Presence mode allows the output to turn on when movement is detected and off when movement ceases. Absence mode allows the output to turn off when movement ceases, but must be manually turned on first.
Shift							Use this button to select the settings in red and blue signified by the 'Shift 1' and 'Shift 2' LEDs

UHS5 Programming























For Dimming models including '-DD/SR' and '-AD' models



For most basic programming operations the UHS5 handset can be used and the following procedures are based on using this device.

Point the handset at the sensor and send the required programming commands to the unit as shown below. Valid commands will be indicated by a red LED flash. See page 1 for details of other LED responses.

Note: other functions on the UHS5 which are not shown below are not applicable to this product.

Parameter Name	Default Value	Number of shift  presses				UHS5 Handset Graphics	Description
		0  SHIFT 1  SHIFT 2	1  SHIFT 1  SHIFT 2	2  SHIFT 1  SHIFT 2	3  SHIFT 1  SHIFT 2		
On / Raise		On	Raise	Cancel override on			Turn lights on or to raise lights.
Off / Lower		Off	Lower	Cancel override off			Turn lights off or to lower lights.
Walk test	Off	On	Off				When set to On this causes a red LED to flash on the sensor when it detects movement. Use this feature to check for adequate sensitivity levels.
Time Out (Time adjustment)	20 mins	1, 10 & 20 minutes	5, 15 & 30 minutes	10 seconds (5/1 button)			Once the detector is turned on, this value sets how long the lights will stay on once movement has ceased.
LUX on level (Switch level on)	9	2, 5 & 7	4, 6 & 9				LUX level setting to prevent the luminaires from being switched on if the light level is sufficient (adjustable between 2 and 7). The luminaires will always be switched on at level 9.
Light Level	6 9 (V3)			2, 5 & 7	4, 6 & 9		Sets a target preset light level between 2 and 7 to be maintained by the lighting system. 9 = disabled.
LUX off level (Switch level off)	9	2, 5 & 7	4, 6 & 9				LUX level setting switches the luminaires off if the light level goes above the setting (adjustable between 2 and 7). Level 9 will always keep the lights on. This setting can be used for "window row switching". Note: the LUX Off Level value must always be greater than the LUX On Level value.
Load type	DALI D_ON (V3)			2 – Dali 7 – DSI	2 – D_ON		Sets the ballast control protocol to be used by the output channel.
Sensitivity	9	1, 5 & 9	3, 6 & 8				For both ON and OFF, sensitivity level for detecting movement. 1 = low sensitivity 9 = high sensitivity
Defaults				D			Returns the unit to the default settings.
Burn-in (Hours)	0	0	50	100			Determines how long the output will be at 100% so that lamps 'burn-in'. The 'burn-in' time is not affected by power supply interruptions.
Presence / Absence	Presence	Presence	Absence				Presence mode allows the output to turn on when movement is detected and off when movement ceases. Absence mode allows the output to turn off when movement ceases, but must be manually turned on first.
Shift							Use this button to select the settings in red and blue signified by the 'Shift 1' and 'Shift 2' LEDs

UNLCDHS

Universal Handset Programming



UNLCDHS Programming

Programming overview



This guide is for programming old and newer versions of presence detectors. If you are not sure what version of detector you have, use the **identify function** under **STANDALONE** products menu to read back from the sensor.

Some parameters are available for certain products only.

Certain parameter functions are only available in specific versions of the detectors and the version numbers are indicated under the affected parameter headings within the brackets e.g. LUX Learn Level (V3).



The functionality of programmable devices is controlled by a number of parameters which can be configured and changed by the UNLCDHS Infrared Handset with LCD display.

Basic UNLCDHS handset operation

1. Press  and hold for 3 seconds to turn the handset on.
2. Select the product family from the main **PRODUCT FAMILY** menu and press .
3. Either select the specific product or **Generic Product** and press . **Generic Product** lists all the parameters used within the family, but some might not be available or applicable for all products.
4. Select the parameter group to program and press .
5. Select the parameter using  and .
6. Enter parameter values. There is no need to press  after entering a number.
7. Point the handset directly at the device and press  to send the currently selected parameter.

Each device is fitted with an LED that flashes when it successfully receives a valid command - it won't flash if the parameter doesn't apply to the device or the value is out of range.

Note: Changes that are committed to non-volatile memory will be acknowledged 4 seconds later by a double flash of the walk-test LED on the sensor.

UNLCDHS Programming

Readback function (UNLCDHS handset only)

The UNLCDHS has the ability to read back the settings stored in a device.

To read back individual parameters

- Navigate to the parameter and apply a short momentary push to the 'R' (Read) button whilst pointing at the device. The device will flash its LED, and the value will be shown against the parameter in the menu.

To read back all of the parameters in a menu

- Press and hold the 'R' (Read) button for more than 1 second.
- The handset will click every time a parameter is received
- The device will show multiple flashes of its LED
- All of the values will be shown against the parameters in the menu.
- The individual parameters may be edited and then saved as a 'Macro'.























Notes

- If a parameter(s) has been missed because of a communication error, the missing value(s) is replaced by dashes.
- When reading back, the Channel 1 relay (where fitted) will temporarily be switched off, and will return to its normal state 2 seconds after the read back has been completed. The channel 2 relay will similarly switch off for 2 channel type units.

UNLCDHS Programming

Keypad operation



Button	Short Press	Long Press	 +
	Displays a list of the items in the currently loaded macro. Press again to send the parameters.	–	Lists all saved macros.
	Adds an item to the current macro.	–	Switches between saving the current macro or recording a new one.
	Selects the channel to configure. This only affects devices that have more than one channel.	–	–
	Increases backlight for 5 presses, then back to off.	–	Decreases backlight level.
	–	Switches the handset on and off.	–
	Displays the help screen for the selected item. Press again to cancel.	–	Shows software version number.
	Returns to the root menu for the current product family.	Returns to the PRODUCT FAMILY menu.	–
	Reads back the currently selected parameter.	Reads back all the parameters in the current menu.	–
	Sends the currently selected parameter.	–	Sends all the parameters in the current menu.
	Selects the submenu.	–	–
	Returns to previous list.	–	–
	Scrolls up the page.	–	–
	Scrolls down the page.	–	–
	Selects the submenu. Also confirms handset configuration changes.	–	–
	Selects No ; reduces the value of the selected parameter, removes a value from a list.	Continuously decreases the value of the selected parameter.	–
	Selects Yes ; increases the value of the selected parameter; adds a value to a list.	Continuously increases the value of the selected parameter.	–
	Number 1, or cycles through a list of symbols.	–	–
 	Numbers 2 to 9, or cycles through the list of corresponding letters (e.g. 2 = ABC).	–	–
	Changes between upper case and lower case.	Toggles Caps Lock on and off.	–
	Zero, or the space character.	–	–
	Deletes a single character or item.	Resets the parameter to its default value.	–

UNLCDHS Programming

Parameters



Basic LUX switching settings

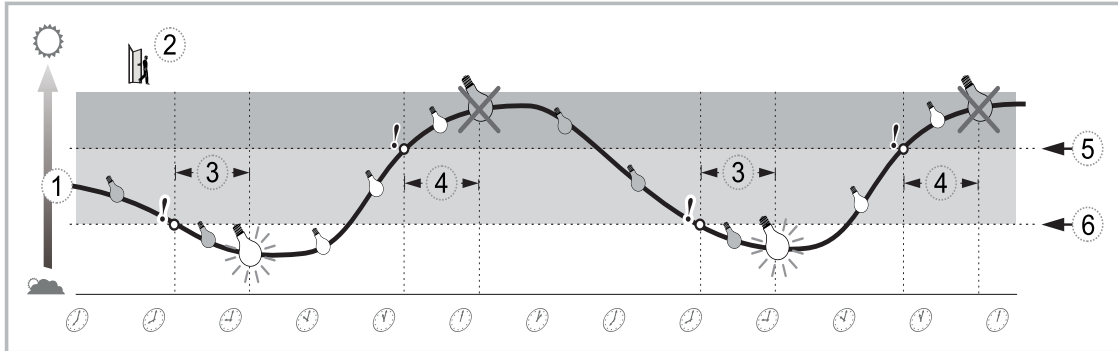

- 1. Ambient light level
- 2. Occupancy
- 3. LUX on time
- 4. LUX off time
- 5. LUX off level
- 6. LUX on level

Kindly refer to the product manual of the specific model for the usable LUX range. For version V3 sensors, limit the target LUX setting to within 950 LUX which when mounted on the ceiling would equate to around 3000LUX on desk level for an example floor & furniture reflectance factor situation of 0.3. For versions previous to V3, limit the target level to within 300 which would equate to 1000 LUX on the desk under the same reflectance conditions.

Basic dimming settings (without step fade)

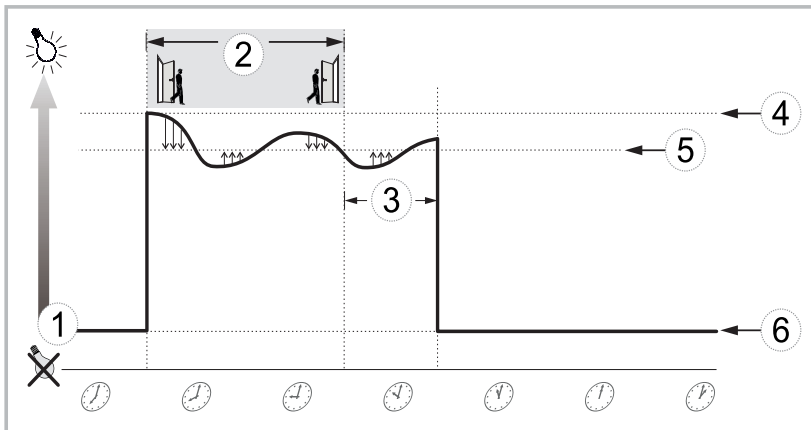

- 1. Output level
- 2. Occupancy
- 3. Timeout
- 4. On value
- 5. Light level (MI)
- 6. Off value

Basic dimming settings with step fade

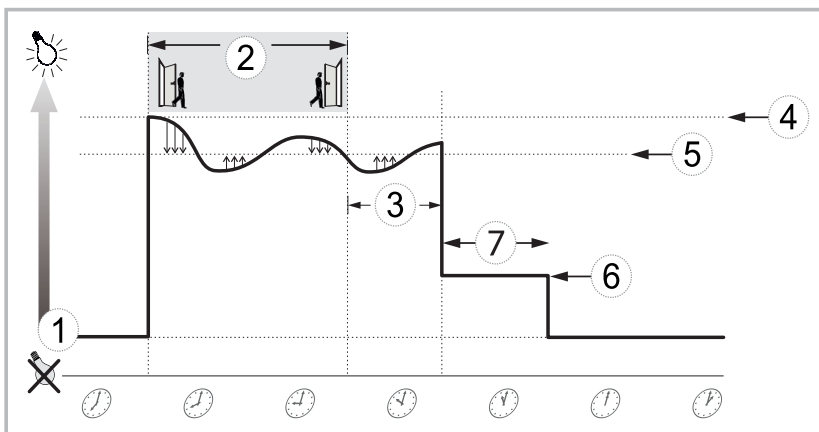

- 1. Output level
- 2. Occupancy
- 3. Timeout
- 4. On Value
- 5. Light level (MI)
- 6. Fade Value or Fade Off level (V3)
- 7. Fade Time or Fade Off Time (V3)

UNLCDHS Programming – Channel Dimming and Switch Mode Explained



Channel 1 (switched output) of the detectors can either be used to switch a separate channel of standard, non-dimming luminaires, or to isolate the mains supply to dimming ballasts (saving on the standby current of the ballasts).

Multiple luminaires may be connected in parallel to Channel 1 (via the N and L/Out terminals) as long as the maximum total load is not exceeded.

Channel 2 (dimmable output) of the detectors can be used to control the light output of luminaires that are fitted with dimming ballasts/transformers.

The ballasts/transformers can be connected in parallel to Channel 2 (via the DIM– and DIM+ terminals).

The wiring examples below show common methods of connecting switch inputs and the output channels for a single detector unit.

Single channel dimming

Functions: Switches the luminaire with occupancy and maintains illuminance. Dims and switches using optional centre biased retractive switch (Legrand Synergy 735414 grid switch or MK K4900 or similar).

Configured to presence detection: Turns on automatically with occupancy. Maintains illuminance. Press and release down switch to turn off. Press and release up switch to turn back on. Press and hold up switch to dim up, press and hold down switch to dim down. Turns off after occupancy.

Configured to absence detection: Press and release up switch to turn on. Maintains illuminance. Press and release down switch to turn off. Press and hold up switch to dim up, press and hold down switch to dim down. Turns off after occupancy.

Channel mode: Set to "Switch and dim together".

Switch mode: Set to "2 position switch together".

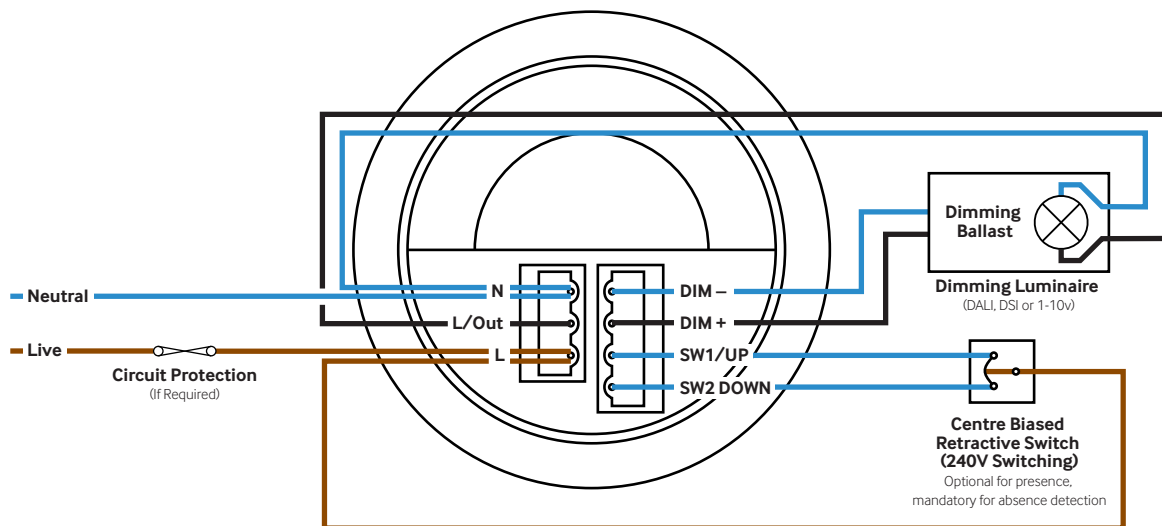

When there is a requirement to have an 'Off' state that results in a low-lit level, then use the DSI / DALI lines as dimming control with an unswitched live feed direct to the ballast. Set the 'Off value' (in the Advanced Programming section) to a value greater than zero to achieve this low-lit dimmed level for the 'Off' state. See the diagram below for wiring details.

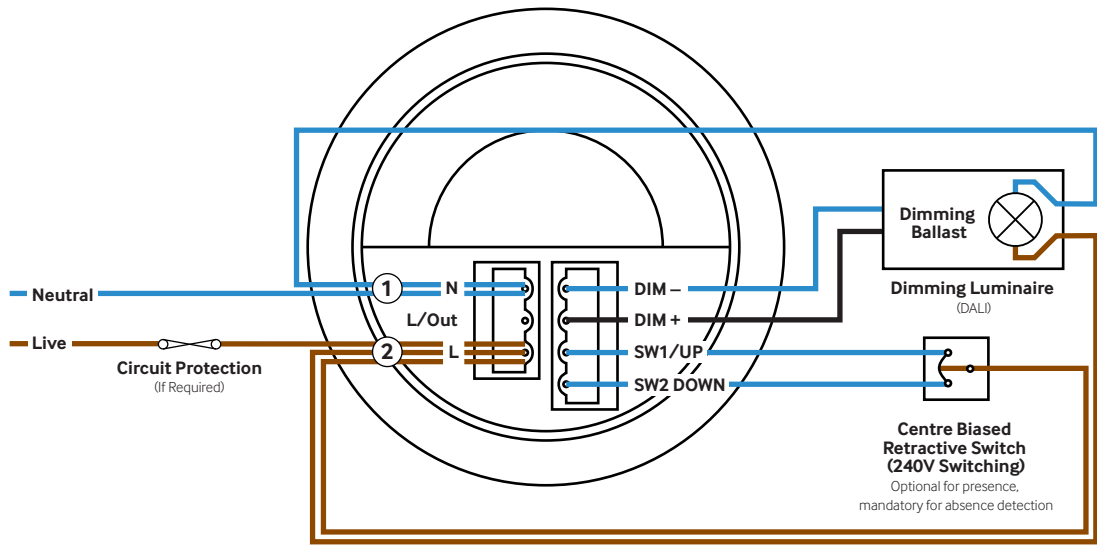

Two channel, individual switches

Functions: Switches both channels with occupancy. Maintains illuminance, dims and switches the dimming channel using optional single position retractive switch (switch 2). Switches the switching channel using the optional single position retractive switch (switch 1). For example Legrand Synergy 735415 grid switch or MK K4885 or similar.

Configured to presence detection: Turns on automatically with occupancy. Maintains illuminance (dimming channel only). Press and release switch to toggle output. Press and hold switch to dim up and down (reverses direction with each press). Turns off after occupancy.

Configured to absence detection: Press and release switch to turn on. Maintains illuminance (dimming channel only). Press and release switch to turn off. Press and hold switch to dim up and down (reverses direction with each press). Turns off after occupancy.

Channel mode: Set to "Switch and dim separate"

Switch mode: Set to "1 position switch separate"

Please note that the dimming signal is used to switch the dimming luminaire on/off and therefore the 240V feed to the luminaire fitting must come from the permanent live supply.

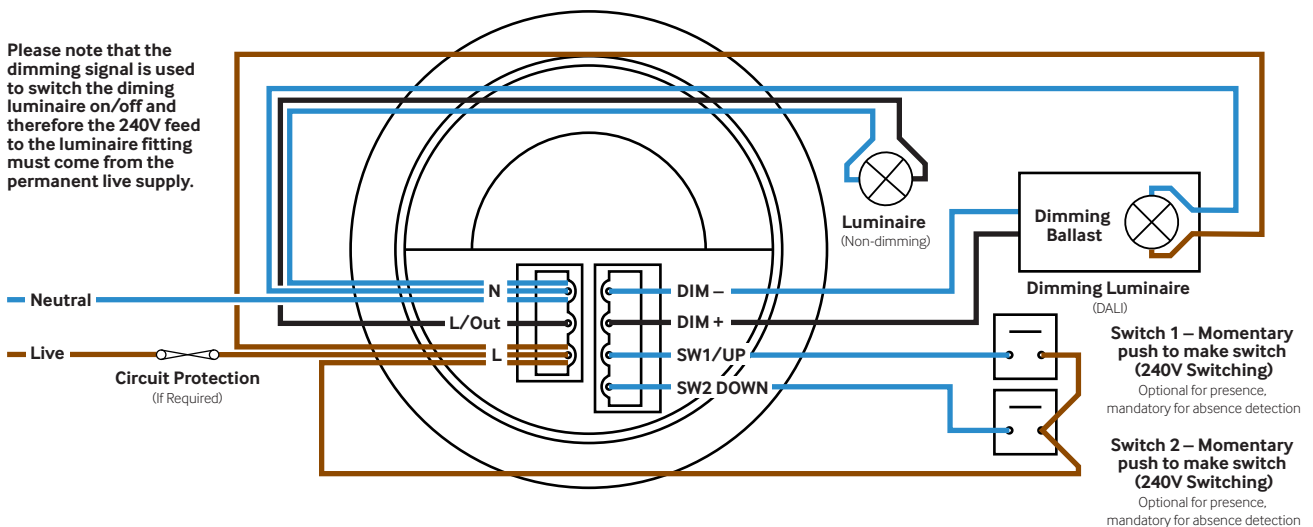

Two channel, single switch

Functions: Switches both channels with occupancy. Maintains illuminance, dims and switches the dimming channel using optional centre biased retractive switch. For example, Legrand Synergy 735414 grid switch or MK K4900 or similar.

Configured to presence detection: Turns on automatically with occupancy. Maintains illuminance (dimming channel only). Press and release down switch to turn off. Press and release up switch to turn back on. Press and hold up switch to dim up, press and hold down switch to dim down. Turns off after occupancy. Channel 1 does not operate with switch

Configured to absence detection: Press and release up switch to turn on. Maintains illuminance (dimming channel only). Press and release down switch to turn off. Press and hold up switch to dim up, press and hold down switch to dim down. Turns off after occupancy. Channel 1 does not operate with switch.

Channel mode: Set to "Switch and dim separate"

Switch mode: Set to "2 position switch separate"

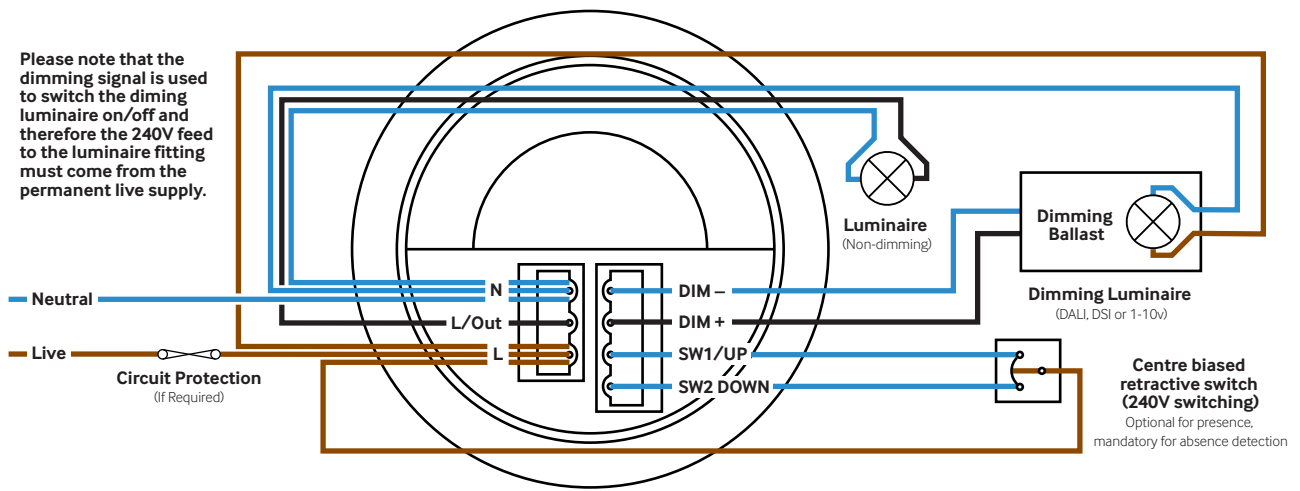

Please note that the centre biased retractive switch will provide control for the dimming luminaire(s) only. The non-dimming luminaire(s) will be controlled only by the sensor

Single channel switching

Functions: Switches channel 1 only with occupancy, optional override switch. No dimming output.

Configured to presence detection: Turns on automatically with occupancy. Press and release down switch to turn off. Press and release up switch to turn back on. Turns off after occupancy.

Configured to absence detection: Press and release up switch to turn on. Press and release down switch to turn off. Turns off after occupancy.

Channel mode: Set to "Switch only"

Switch mode: Set to "2 position switch together".

Note: a single position switch can be used instead to toggle the output, set to "1 position switch separate".

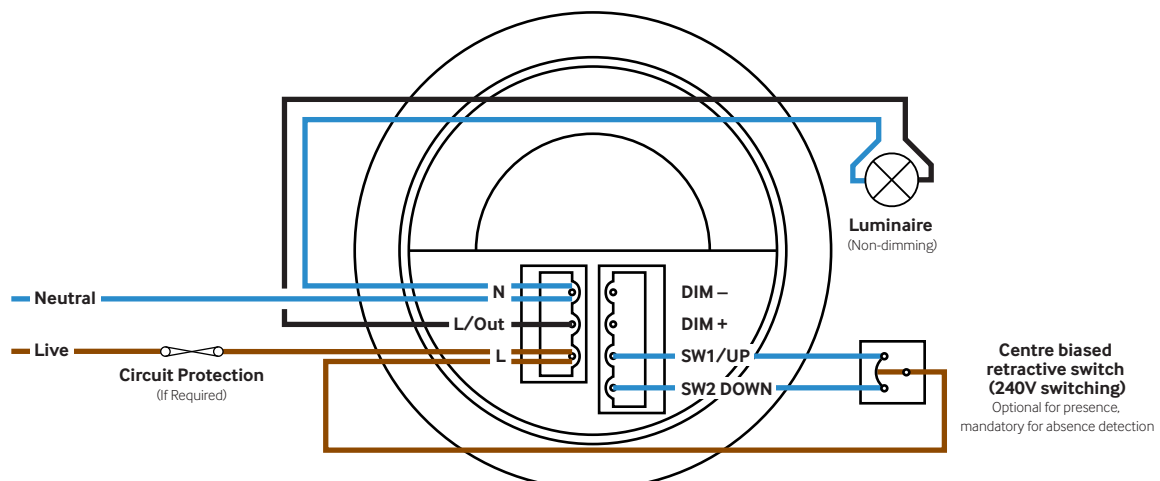

Two channel switching for PRM-2CH models

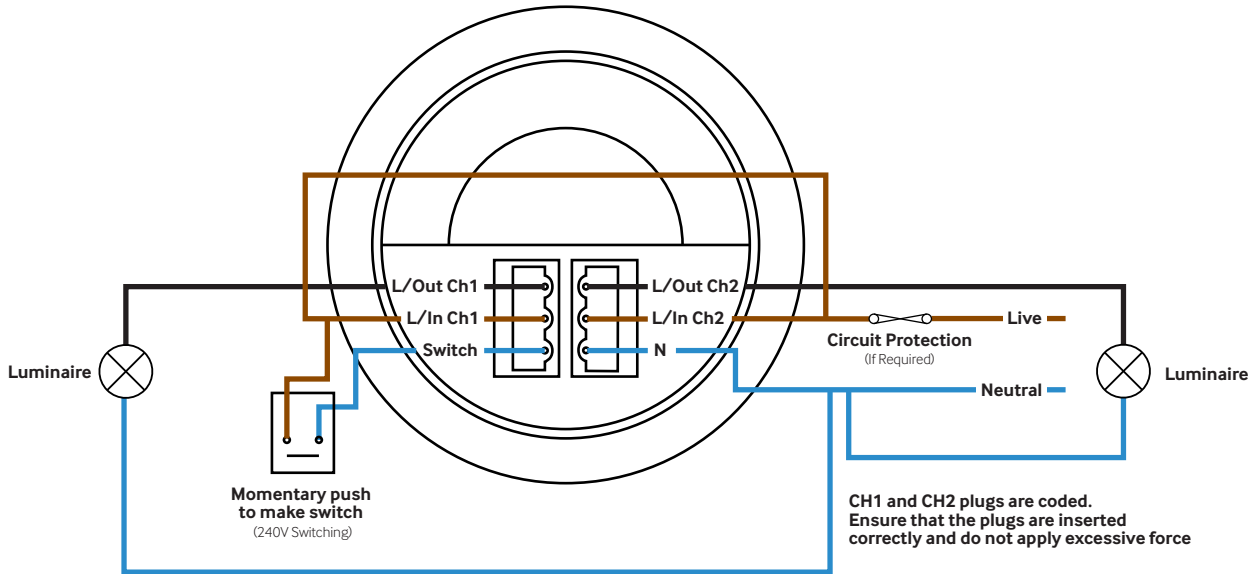

UNLCDHS Programming

Basic Parameter Settings



UNLCDHS Programming – Detector Parameters (Ch. 1 & 2)

Basic Parameters for all models including '-PRM' and '-PRM-2CH', '-DD/SR' and '-AD'



Parameter	Default	Range / Option	Description
Detection Mode	Pres (Presence)	Pres (Presence) / Abs (Absence)	Select Pres to turn lights on when movement is detected and off when movement ceases. Select Abs to turn lights off when movement ceases, but the lights must be manually turned on by a switch or handset first.
Timeout	20	0 – 99 minutes	How long the lights stay on for after movement has stopped. This sets both Timeout (channel 1) and Timeout (channel 2) to the same value. Select 0 for a 10 second delay (use for commissioning only).
Abs Recovery (secs) (V3)	10	0 – 99 seconds	Sets a period for a detector in Absence mode to operate in Presence mode after lights are turned off. This enables a person to use movement to re trigger lights which have switched off while they are still in the room. If Abs Recovery (secs) is set to a non-zero value you should also set Inhibit to 0 to detect any occupancy immediately.
Sensitivity On	9	1 – 9	Sensitivity level for detecting further movement when the lights are already on. 1 = minimum, 9 = maximum (least movement required to trigger the lights). (UHS5 sets Sensitivity On and Sensitivity Off to the same value.)
Sensitivity Off	9	1 – 9	Sensitivity level for detecting any movement when the lights are off. 1 = minimum, 9 = maximum (least movement required to trigger the lights). (UHS5 sets Sensitivity On and Sensitivity Off to the same value.)
Manual Timeout (Not for '-2CH' models)	10		How long the lights stay off after they have been turned off using a switch or handset before returning to the automatic Timeout operation. The following examples are for a detector in presence mode with Timeout set to 15 minutes and Manual Timeout to 3 minutes: Example 1: When the user leaves the room they switch the light off. The lights stay off for 3 minutes even someone walks back into the room. The sensor will revert to automatic after 3 minutes, and then walking back in the room will turn the lights on - the lights will then stay on until no movement has been detected for 15 minutes. Example 2: The user turns the lights off but stays in the room (for example to give a presentation). Every time a movement is detected, the 3 minute timeout period is re triggered, but if no movement is detected for this period operation reverts to automatic. This means the lights may turn on inadvertently during the presentation if the occupants are still for 3 minutes, so you should adjust the manual timeout carefully.
Walk Test LED	Off	On / Off	When set to On a red LED on the sensor flashes when movement is detected. Use this feature to check for adequate sensitivity levels.
Disable Detect	No	Yes / No	Disables presence / absence detection, so that the detector can't control switching but can control dimming output. Use this mode when the unit is for maintained illuminance only.
Relay State when Det Disabled (V3)	Off	On / Off	If Disable Detect is set Yes, setting Relay State when Det Disabled to On keeps the channel 1 relay output closed. Setting it to Off keeps the relay open.
Power Up State	Yes	Yes / No	Select No for a 40 second delay after initial power up before the detector starts detecting and changing outputs. Select Yes for no delay - the detector will always power up detecting.
Inhibit (secs)	1	1 - 99 seconds	The time to wait after the detector turns lights off before it can retrigger them. If using the device in Absence mode, set this time to 0.

Note: Certain parameter functions are only available in specific versions of the detectors and these are indicated under the affected parameter headings within the brackets e.g. LUX Learn Level (V3).

UNLCDHS Programming – LUX Control (applies to both Ch. 1 & 2)

Basic Parameters for all models including '-PRM', '-PRM-2CH', '-DD/SR' and '-AD'



Parameter	Default	Range / Option	Description
Light Level (MI)	999	1 – 950 (999 = maintained illuminance off)	<p>Sets a target light level to be maintained by the lighting system. (The maintained illuminance is not applicable to '-PRM' products)</p> <p>For version V3 sensors, limit the target LUX setting to within 950 LUX which when mounted on the ceiling would equate to around 1900LUX on desk level for a reflectance factor situation of 0.5. For versions previous to V3, limit the target level to within 300 which would equate to 560 LUX on the desk under the same reflectance conditions.</p>
LUX Learn Level (V3)	0	0 – 950	Use with the Readback function to get the LUX level the unit is currently reading. Press Send to update the Light Level (MI) parameter with this value.
Auto Brightness % (V3)	0	0 – 100 (0 = disabled)	Instead of setting LUX ON and OFF as individual parameters, Auto brightness sets these parameters as the assigned percentage of the LUX learn level. (The maintained illuminance is not applicable to '-PRM' products)
LUX On Level	999	1 – 9 (V2) 1 – 950, 999=disabled (V3)	<p>Sets the light level below which will turn on the output in conjunction with movement control. The output will turn on without movement should the Disable Detect parameter be set to YES.</p> <p>Value 9 (V2) or 999 (V3) disables both LUX ON and LUX OFF functions. The LUX Off Level value must always be greater than the LUX On Level value.</p>
LUX Off Level	999	1-9 (V2) 1 – 950, 999=disabled (V3)	<p>Sets the light level above which will turn OFF the output in conjunction with movement control.</p> <p>Value 9 (V2) or 999 (V3) disables both LUX ON and LUX OFF functions. The LUX Off Level value must always be greater than the LUX On Level value.</p>
LUX Time (V2)	0	0 (disabled) 1 – 99 mins	<p>If the detector measures the LUX level and decides that the output needs switching on or off as a consequence, the LUX time must elapse first. If at any time during the timed delay the LUX change reverses then the process is cancelled.</p> <p>LUX Time enables absence detection to be implemented with a LUX off level set. When the button is pressed, the lights will go on, regardless of ambient light level. However, if there is sufficient ambient light, they will turn off again after the LUX Time.</p> <p>Note: Whenever the an external switch is pressed, whether in absence or presence mode, if the lights were out because of the LUX level, they will be immediately turned on again for at least the LUX Time.</p>
LUX On Time (V3)	0	0 – 99 minutes	<p>When the ambient light falls below LUX ON Level, the time to wait before switching on the lights. If at any time during the timed delay the LUX change reverses then the process is cancelled. Minimum time of around 15 seconds is set for a value of 0.</p> <p>If you try to turn lights on using a switch or handset, the lights will go on regardless of ambient light level. However, if there is sufficient ambient light, they will turn off again after LUX Off Time.</p>
LUX Off Time (V3)	0	0 – 99 minutes	When the ambient light rises above LUX OFF Level, the time to wait before switching off the lights. If at any time during the timed delay the LUX change reverses then the process is cancelled. Minimum time of around 15 seconds is set for a value of 0.
LUX Switch NZOL (V3)	No	Yes / No	For future use. Leave "No"

Note: Certain parameter functions are only available in specific versions of the detectors and these are indicated under the affected parameter headings within the brackets e.g. LUX Learn Level (V3).

UNLCDHS Programming – User

Basic Parameters for all models including '-PRM', '-PRM-2CH', '-DD/SR' and '-AD' and their variants



Parameter	Default	Range / Option	Description
Manual Override On	–	–	Turns lights on and reverts to automatic operation after the period set by Manual Timeout in the Detector Params menu.
Manual Override Off	–	–	Turns lights off and reverts to automatic operation after the period set by Manual Timeout in the Detector Params menu.
Manual Override Cancel	–	–	Cancels the manual on and off overrides, returning the detector to normal operation.

Note: Certain parameter functions are only available in specific versions of the detectors and these are indicated under the affected parameter headings within the brackets e.g. LUX Learn Level (V3).

UNLCDHS Programming

Advanced Parameter Settings



UNLCDHS Programming – Configuration

Advance Parameters for all models including '-PRM' and '-PRM-2CH', '-DD/SR' and '-AD'



Parameter	Default	Range / Option	Description
Channel Mode (not applicable to V2 PRM models)	Switch and dim together	Switch only Switch and dim together Switch and dim separate	<p>Submenu to configure dimming controls.</p> <p>Switch only Choose this option if the dimming channel is not required (for example with single channel devices) Usually used for absence detection, as in this mode the dimming channel is not used.</p> <p>Switch and dim together (not applicable to PRM models) Choose this when the channel 1 output is also used to power dimming luminaires on channel 2. If both channels are powered by an external source there is a 1 second delay between channel 1 luminaires being switched and dimming commands being sent on channel 2. To avoid this delay use the Switch and dim separate option.</p> <p>Switch and dim separate (not applicable to PRM models) Choose this option on unit when channel 1 is switched using the relay output and channel 2 is powered from an external 230V power source so that both channels work independently.</p>
Switch Mode (PRM models)	Long Press Off, Short Press On	Long Press Off, Short Press On Short Press Off, Short Press On	<p>Submenu to configure switches.</p> <p>Long Press Off, Short Press On (1 position switch together in pre V3 models) A single momentary switch where you must press for 3 seconds to switch the load OFF and a short press ON.</p> <p>Short Press Off, Short Press On (2 position switch together in pre V3 models) A single momentary switch where a short press switches the load ON and another short press to switch OFF.</p>
Switch Mode (PRM-2Ch models)	Long Press Off, Short Press On		<p>Long Press Off, Short Press On & 1 position switch together A single position retractive switch controls both channels together.</p> <p>Long Press Off, Short Press On & 1 position switch separately Two single position retractive switches, controlling the channels separately</p> <p>Short Press Off, Short Press On & 2 position switch together A single position retractive switch controls both channels together.</p> <p>Short Press Off, Short Press On & 2 position switch separately Two single position retractive switches, controlling the channels separately</p>
Switch Mode (dimming control models DD, AD etc..)	2 position switch together		<p>2 position switch together: A single centre biased retractive switch will control both channels together.</p> <p>2 position switch separately: A single centre biased retractive switch will control only the dimming channel.</p> <p>1 position switch together: A single position momentary switch will control both channels together.</p> <p>1 position switch separately: Two single position momentary switch will control the channels separately.</p>
Factory Reset	–	–	Clears any programmed settings and returns the device to its default set-up.
Soft Reset	–	–	Reboots the device, but retains all current settings. Must leave value at zero.
LUX Cal Value (V3)	0	0 – 999	Enter the current reading of a LUX meter to calibrate the scale of the photocell in the detector. Must reset and send to 0 before applying a new setting.
LUX Cal Factor (V3)	0	0 – 255	Reads back the effective scaling factor calculated from the photocell LUX Learn reading and LUX Cal Value.
IR Enabled (V3)	Yes	Yes / No	Set to No to prevent the device from receiving commands from the handset. The device's LED will flash several times if you try to send a command when in this state. Set to Yes to re enable programming.

Note: Certain parameter functions are only available in specific versions of the detectors and these are indicated under the affected parameter headings within the brackets e.g. LUX Learn Level (V3).

UNLCDHS Programming – Output Ch. 1

Advance Parameters for all models including '-PRM', '-PRM-2CH', '-DD/SR' and '-AD'



Parameter	Default	Range / Option	Description
Detection Mode	Pres	Pres (Presence) / Abs (Absence)	Select Pres to turn lights on when movement is detected and off when movement ceases. Select Abs to turn lights off when movement ceases, but the lights must be manually turned on by a switch or handset first.
Timeout	20 minutes	0 – 99 minutes	How long the lights stay on for after movement has stopped. (Channel 1). Select 0 for a 10 second delay (use for commissioning only).
Abs Recovery (secs) (V3)	10	0 – 99 seconds (applies to both channels in '-2CH' models)	Sets a period for a detector in Absence mode to operate in Presence mode after lights are turned off. This enables a person to use movement to re trigger lights which have switched off while they are still in the room. If Abs Recovery (secs) is set to a non-zero value you should also set Inhibit to 0 to detect any occupancy immediately .
Relay Status (V3) (Not for '-2CH' models)	Off	On / Off	Use with the Readback function to see whether the detector switch relay is currently in an On or Off state.
LUX On Level	999	1 – 9 (V2) 1 – 950, 999=disabled (V3)	Sets a minimum ambient light level below which lights are turned on by movement. The LUX Off Level value must always be greater than the LUX On Level value.
LUX Off Level	999	1 – 9 (V2) 1 – 950, 999=disabled (V3)	Sets a maximum ambient light level above which lights cannot be turned on by movement. The LUX Off Level value must always be greater than the LUX On Level value.
LUX On Time (V3)	0	0 – 99 minutes	When the ambient light falls below LUX On Level, the time to wait before switching on the lights. If at any time during the timed delay the LUX change reverses then the process is cancelled. Minimum time of around 15 seconds is set for a value of 0. If you try to turn lights on using a switch or handset, the lights will go on regardless of ambient light level. However, if there is sufficient ambient light, they will turn off again after LUX Off Time.
LUX Off Time (V3)	0	0 – 99 minutes	When the ambient light rises above LUX Off Level, the time to wait before switching off the lights. If at any time during the timed delay the LUX change reverses then the process is cancelled. Minimum time of around 15 seconds is set for a value of 0.
On Delay	0	0 – 99 minutes	Enables Channel 1 to switch on a number of minutes after Channel 2. For example if a detector is controlling lighting on Channel 2 and air conditioning on Channel 1, when an occupant is detected, the lighting turns on immediately, but the air conditioning turns on after 5 minutes. If the area is vacated and the detector times out before the delay, then the air conditioning would never go on.
EBDHS High Bay models only	–	–	Submenu for configuring high-bay detectors. PIR 1–5 Switches each of the 5 sensors within the detector on or off individually. Default = On, Option = On / Off Verify Mode Requires at least 2 sensors within the detector to detect movement before triggering the lights. Default = Yes, Option = Yes / No

Note: Certain parameter functions are only available in specific versions of the detectors and these are indicated under the affected parameter headings within the brackets e.g. LUX Learn Level (V3).

UNLCDHS Programming – Output Ch. 2

Advance Parameters for all models including '-PRM' and '-PRM-2CH'



Parameter	Default	Range / Option	Description
Detection Mode	Pres	Pres (Presence) / Abs (Absence)	Select Pres to turn lights on when movement is detected and off when movement ceases. Select Abs to turn lights off when movement ceases, but the lights must be manually turned on by a switch or handset first.
Timeout (V3)	20 minutes	0 – 99 minutes	How long the lights stay on for after movement has stopped. (Channel 2). Select 0 for a 10 second delay (use for commissioning only).
Abs Recovery (secs) (V3)	10	0 – 99 seconds (For '-2CH' models, this MUST be set the same as CH1)	Sets a period for a detector in Absence mode to operate in Presence mode after lights are turned off. This enables a person to use movement to retrigger lights which have switched off while they are still in the room. If Abs Recovery (secs) is set to a non-zero value you should also set Inhibit (secs) to 0 to detect any occupancy immediately.
LUX On Level	999	1 – 9 (V2) 1 – 950, 999=disabled (V3)	Sets a minimum ambient light level below which lights are turned on by movement. The LUX Off Level value must always be greater than the LUX On Level value.
LUX Off Level	999	1 – 9 (V2) 1 – 950, 999=disabled (V3)	Sets a maximum ambient light level above which lights cannot be turned on by movement. The LUX Off Level value must always be greater than the LUX On Level value.
LUX On Time (V3)	0	0 – 99 minutes	When the ambient light falls below LUX On Level, the time to wait before switching on the lights. If at any time during the timed delay the LUX change reverses then the process is cancelled. Minimum time of around 15 seconds is set for a value of 0. If you try to turn lights on using a switch or handset, the lights will go on regardless of ambient light level. However, if there is sufficient ambient light, they will turn off again after LUX Off Time.
LUX Off Time (V3)	0	0 – 99 minutes	When the ambient light rises above LUX Off Level, the time to wait before switching off the lights. If at any time during the timed delay the LUX change reverses then the process is cancelled. Minimum time of around 15 seconds is set for a value of 0.

Note: Certain parameter functions are only available in specific versions of the detectors and these are indicated under the affected parameter headings within the brackets e.g. LUX Learn Level (V3).

UNLCDHS Programming

Advanced Parameter Settings
For Dimming Controllable Units
'-DD/SR' and '-AD' and Variants



UNLCDHS Programming – Output Ch. 2

Advance Parameters available for Dimming models including '-DD/SR' and '-AD' and their variants only



Parameter	Default	Range / Option	Description
On Scene (V3)	1	1 – 8	Default scene to switch to after the detector times out and then powers up.
Load Type (Gear type)	0_10V or D-ON depending on product	DSI / D-ON / 0_10V / 1_10V depending on product	Indicates the dimming ballast type. DSI Sets the drivers control protocol to DSI for DD sensors. D-ON Sets the drivers control protocol to DALI for DD sensors. 1_10V Sets the drivers control to 1-10V output for analogue dimming devices for AD sensors. 0_10V Sets the drivers control to 0-10V output for analogue dimming devices for AD sensors. DALI Note: The DALI option may be found on the handset but this is replaced by the D-ON option.
On Value	99	0 – 99	Dimmed output level when lights manually switched on or via detection of occupancy.
Fade On Level (V3)	99	0 – 99	For future use. Leave as default values.
Gradual Fade On Time (V3)	0	0 – 99 minutes	For future use. Leave as default values.
Fade Off Level (V3)	0	0 – 99	Set the Stepped Fade Off light output level (%) to hold after occupancy has timed out. This level which would last the period specified in the Stepped Fade Off Time parameter before turning off. Note when this function is used, both channel 1 and channel 2 will work and switch off together and can no longer be treated as independently controlled.
Gradual Fade Off Time (V3)	0	0 – 99 minutes	For future use. Leave as default values.
Stepped Fade Off Time (V3)	0	0 – 99 minutes	Sets the time period of the Stepped Fade output level before turning off.
Dim Output (V3)	0	0 – 99	Use with the Readback function to see the dimming output level currently being sent to luminaires.
Fade Value (V2)	10	0 – 99	After occupancy ceases, this dimming output level is loaded for the fade time.
Fade Time (V2)	0	0 – 99 minutes	This is the time period (adjustable between 0 and 99 minutes) that the luminaire will be held at the fade value before turning off. A value of 0 disables the fade function.

Note: Certain parameter functions are only available in specific versions of the detectors and these are indicated under the affected parameter headings within the brackets e.g. LUX Learn Level (V3).

UNLCDHS Programming – Output Ch. 2

Advance Parameters for Dimming models '-DD/SR' and '-AD' and their variants only



Parameter	Default	Range / Option	Description
Off Value	0	0 – 99	Dimmed output level when lights manually switched off or after detector times out.
Max Value	99	0 – 99	Maximum dimming output level.
Min Value	1	0 – 99	Minimum dimming output level.
Memorise (V2) Switch memorise (V3)	No	Yes / No	If set to Yes, the last manually set output level will be memorised and used as the switch ON level.
Burn-in Hours	0	1 – 999 hours (0 = disabled)	Determines how long the output will be at 100% so that new lamps burn-in. The burn-in time is not affected by power supply interruptions.
Speed (On)	40	0 – 99 seconds	Determines the dimming response speed during the set up time upon power ON. Measured in 0.1 sec intervals. If set to "0" will disable dimming for Set Seconds below, used if fittings are required to warm up before dimming.
Speed (Setup)	5	0 – 99	Determines how long the dimming response set-up period lasts upon power-up or on setting change. This enables a faster set up time.
Set Seconds	120	0 – 999 seconds	Sets the dimming response speed after the setup time has finished. Measured in 0.1 sec intervals (i.e. a value of 40 means 4 seconds).
EBDHS High Bay models only	–	–	Submenu for configuring high-bay detectors. PIR 1-5 Switches each of the 5 sensors within the detector on or off individually. Default = On, Option = On / Off Verify Mode Requires at least 2 sensors within the detector to detect movement before triggering the lights. Default = Yes, Option = Yes / No

Note: Certain parameter functions are only available in specific versions of the detectors and these are indicated under the affected parameter headings within the brackets e.g. LUX Learn Level (V3).

UNLCDHS Programming – User

Basic Parameters for all models including '-PRM', '-PRM-2CH', '-DD/SR' and '-AD' and their variants



Parameter	Default	Range / Option	Description
Select Scene	1	1 – 8	The preset dimming levels are as follows (does not operate the relay outputs): Scene 1 – Maintained illuminance Scene 2 – 100% Scene 3 – 75% Scene 4 – 50% Scene 5 – 25% Scene 6 – 15% Scene 7 – 10% Scene 8 – 0% (min)
Select Scene (pre V3 models)	6	1 – 6	The preset dimming levels are as follows: Scene 1 – 0% (minimum) Scene 2 – 10% Scene 3 – 25% Scene 4 – 50% Scene 5 – 75% Scene 6 – 100%
Scene Up	–	–	Changes the scene from 1 up to 8. (1–6 for pre V3 models)
Scene Down	–	–	Changes the scene from 8 down to 1. (6 down to 1 for pre V3 models)
Set Scene Level (V3)	0	0 – 255	Changes a particular scene's preset level. Select the scene first using Select Scene and then send Set Scene Level. 255 = 100% 191 = 75% 128 = 50% 64 = 25% 26 = 10% 0 = 0% (min)
Raise	–	–	Increases light level. Reverts to programmed light levels when absence detected.
Lower	–	–	Decreases light level. Reverts to programmed light levels when absence detected.
Manual Override On	–	–	Turns lights on and reverts to automatic operation after the period set by Manual Timeout in the Detector Params menu.
Manual Override Off	–	–	Turns lights off and reverts to automatic operation after the period set by Manual Timeout in the Detector Params menu.
Manual Override Cancel	–	–	Cancels the manual on and off overrides, returning the detector to normal operation.

Note: Certain parameter functions are only available in specific versions of the detectors and these are indicated under the affected parameter headings within the brackets e.g. LUX Learn Level (V3).

UNLCDHS Programming – Device information



Under the device Info menu are items about the device that can be read back to the handset.

Note: Not all devices support any or all of the information below.

- Range: e.g Standalone
- Part number: e.g MWS6
- Variant: e.g DD, PRM output variants
- Version: Version of software of the device.



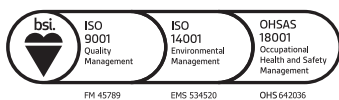

+44 (0)333 900 0671
info@cpelectronics.co.uk
www.cpelectronics.co.uk



CP Electronics, a business unit of Legrand Electric Limited, Brent Crescent, London NW10 7XR, UK

A brand of  **legrand**

Designs and specifications are subject to change without notice.