

## MA-LCD Repeater / Zonal Mimic

Operating and Installation Manual

M-167.6-MA-LCD-EN / 10.2023

### Intended purpose

This product may be used only for the applications outlined in the catalogue and in the technical description, and only in conjunction with the recommended and approved external devices and components.

This documentation contains registered and unregistered trade marks. All trade marks are the property of the respective owners. The use of this documentation does not grant you a licence or any other right to use any name, logo or label referred to or depicted herein.

This documentation is subject to the copyright of Honeywell. The content must not be copied, published, modified, distributed, transmitted, sold or changed without the express prior written permission of Honeywell. The information contained in this documentation is provided without warranty.

### Safety-related user information

This manual includes information required for the proper use of the products described.

In order to ensure correct and safe operation of the product, all guidelines concerning its transport, storage, installation, and mounting must be observed. This includes taking the necessary care when operating the product.

The term 'qualified personnel' in the context of the safety information included in this manual or on the product itself designates:

- project engineers who are familiar with the safety guidelines concerning fire alarm and extinguishing systems.
- trained service engineers who are familiar with the components of fire alarm and extinguishing systems and the information on their operation as included in this manual.
- trained installation or service personnel with the necessary qualifications for carrying out repairs on fire alarm and extinguishing systems, or who are authorised to operate, earth and label electrical circuits and/or safety equipment/systems.

### Symbols

The following information is provided in the interests of personal safety and to prevent damage to the product described in this manual and all equipment connected to it.

Safety information and warnings to prevent hazards endangering the life and health of users and maintenance personnel, as well as causing damage to the equipment itself, are indicated by the following pictograms. Within the context of this manual, these pictograms have the following meanings:



**Warning** - designates risks for man and/or machine. Non-compliance will result in risks to man and/or machine. The level of risk is indicated by the word of warning.



**Note** - important information on a topic or a procedure and other important information.



**Standards and guidelines** - observe configuration and commissioning information in accordance with the national and local requirements.

### Dismantling



In accordance with Directive 2012/19/EU (WEEE), after being dismantled, electrical and electronic equipment is taken back by the manufacturer for proper disposal.

### © Honeywell International Inc./technical changes reserved!

This documentation is subject to copyright law and, as per Sections 16 and 17 of the German Copyright Act (UrhG), may be neither copied nor disseminated in any other way. Any infringement as per Section 106 of the UrhG may result in legal action.

**Contents**

1	DETECTION SYSTEM LIMITS .....	4
1.1	PRECAUTIONS .....	4
1.1.1	NATIONAL STANDARDS .....	5
2	GENERAL DESCRIPTION .....	5
2.1	Display and Control .....	5
2.2	Summary Functions .....	6
3	Technical Characteristics .....	6
3.1	Dimensions .....	7
3.2	LED Symbol Indication .....	7
4	Installation .....	8
4.1	Steps for Installation .....	9
4.2	Serial Data & Power Connections .....	10
4.3	Connection to the Max Panel .....	11
4.3.1	Connection to MA-1000 .....	12
4.3.2	Connections to MA-2000 & MA-8000 .....	13
4.3.3	Daisy chain' Configuration .....	14
5	MA-LCD7 Programming .....	15
5.1	Steps for Programming Repeater/Mimic function .....	15
6	MA-LCD7 Addressing .....	16
6.1	MA-LCD7M Mimic Addressing .....	16
7	Panel Programming .....	17
8	MA-LCD7 Menu options & user Interface .....	18
8.1	MA-LCD7 Repeater & Mimic - Menu options .....	18
8.1.1	MA-LCD7 Repeat and MA-LCD7M Mimic 'UTIL' Utility Menu .....	18
8.1.2	LCD7 Repeater - 'DISABL' Disablement Menu .....	28
8.1.3	MA-LCD7 Repeat - 'TEST' Test Menu .....	30
8.2	MA-LCD7 USER INTERFACE .....	31
8.2.1	Screen Saver (Healthy Status) .....	31
8.2.2	Virtual Zone Indicators .....	32
8.2.3	MA-LCD7 Repeater .....	33
8.2.4	MA-LCD7M Virtual Zonal Mimic .....	42



**Do not try to use the control unit and connected devices without reading this manual.**

# 1 DETECTION SYSTEM LIMITS

An alarm or fire detection system can be very useful for providing a prompt warning of any dangerous events, such as fires, a robbery or a simple burglary, and in some cases, it can automatically manage events (transmit messages for room evacuation, automatic fire-extinguishing, CCTV system interface, access route or door blockage, automatic warning to authorities, etc.), but it does not ensure protection against damage to property or damage caused by fires or robberies).

In addition, systems may not operate properly if they are not installed and maintained according to the manufacturer's instructions.

## 1.1 PRECAUTIONS



- These instructions contain procedures to be followed in order to avoid damage to equipment. It is assumed that the user of this manual has completed a training course and that he knows the applicable rules that are in force.
- The system and all its components must be installed in an environment with the following conditions:
  - Temperature: -5°C ... +40°C.
  - Humidity: 10% ... 93% (non-condensing).
- Peripheral devices (sensors, etc.) which are not perfectly compatible with the control unit may cause damage to the control unit, or cause the system to malfunction at any time. It is therefore essential to only use material which is guaranteed by Honeywell and is compatible with its control units.



- Please consult Honeywell Technical Service if in any doubt.
- This system, like all solid-state components, may be damaged by induced electrostatic voltages: handle the boards by the edges and avoid touching the electronic components.
- In any case, appropriate earthing ensures a reduction in sensitivity to disturbances.
- Please consult Honeywell Technical Service if you cannot solve installation problems.
- No electronic system will operate if it is not supplied with power.
- If the mains power supply fails, the system will still operate using battery power, but only for a limited period.
- During the system planning phase, consider the authority required to ensure the power supply and batteries are appropriately dimensioned.
- Skilled personnel must periodically check the condition of batteries.
- Disconnect the MAINS and the batteries BEFORE removing or inserting any board.
- Disconnect ALL power supply sources from the control unit BEFORE performing any servicing.
- The control unit and the connected devices (sensors, modules, repeaters, etc.) may be damaged if a new board is inserted or removed, or if the powered cables are connected.
- The most common cause of malfunctions is inappropriate maintenance.
- Pay particular attention to these aspects from the start of the system planning phase; this will facilitate future servicing and will reduce cost.



This panel bears the CE marking to indicate conformity with the following European Directives: EMC Directive 2004/108/EC and LVD Directive 2006/95/EC.

### 1.1.1 NATIONAL STANDARDS



**This equipment must be installed and must comply with the instructions and regulations valid at the installation site.**

## 2 GENERAL DESCRIPTION

MA-LCD7 is a remote Repeater for the Morley-IAS Max fire alarm control panel. MA-LCD7 provides remote indication of alarms and events via the panels RS485 serial line. MA-LCD7 can also be programmed to function as a Virtual Zonal Mimic. The MA-LCD7 includes a 7-inch colour resistive touchscreen display, which facilitates the display of events, alarms and data input. The touchscreen display provides users the ability to input data for basic system controls. All controls including Menu options are via the touchscreen display.

When programmed as a Repeater, 6 Virtual Keys will facilitate the following functions:

- Mute Buzzer
- Silence/Resound
- Reset
- Test Menu
- Utility Menu
- Disablement Menu

When programmed as a Zonal Mimic, only the Utility Menu option is available. No control virtual buttons are available on a Zonal Mimic. MA-LCD7 has physical LED indicator symbols on the left of the LCD touchscreen to indicate the status on the Network System or Panel. These include Alarm, General Fault, System Fault, Sounder Silence and Local Power status.

MA-LCD7 utilises Morley-IAS Max's intuitive tabs and navigational user interface (UI), meaning users will be familiar with the navigation controls and Menus. MA-LCD7 UI also includes Max's unique colour coding system which increases users' situational awareness of events and alarms. This includes 40 on screen Virtual Zonal Indicators when programmed as a Repeater, and up to 80 Virtual Zonal Indicators when programmed as a Mimic.

### 2.1 Display and Control

The MA-LCD7 will display all Local and Network events on the Repeater or Local and Network zonal statuses for the Mimic. The MA-LCD7 programmed as a panel Repeater will provide 3 Menu options with sub-menu selections. These Menu options are Utility, Test and Disable.

The Test Menu entrance requires a Level 2 passcode. The Utility Menu entrance requires a Level 3 passcode. The 'Disable' Menu is accessible via Level 1, which does not require a passcode to be entered. The 'Disable' Menu option grants visibility of panel and system disablements. There are no options within the Test or Disablement Menu to program/initiate a system Zone Test or system or point disablement from the Repeaters. These options are view-only, meaning the Repeater will display active Zone Tests and disablements of the panel or Networked system. When the MA-LCD7 is programmed as a Virtual Zonal Mimic, only the Utility Menu is available. No other control function is possible via the Zonal Mimic.

The MA-LCD7 Repeater control options are Silence/Resound and Reset; these control options require the user to enter the Level 2 passcode. After entering the passcode, the command for Silence/Resound and Reset will be sent to the connected control panel. Mute Buzzer is accessible via Level 1 and will mute the Local Buzzer internal on the Repeaters as well as the buzzer(s) of the connected fire panels, either Local or on a Network.

When the Repeater is connected to Max fire alarm control panel, which is part of the CAN Bus Network, these commands will be sent to all panels on the Network. There are no options to limit or restrict these control commands per panel. The control actions from any Repeater or Mimic are regarded as a 'Global' command, which will control all Max fire alarm control panels on the Network.

## 2.2 Summary Functions

Function	Description	Access level
LED Test	Local LED Test. Repeater LED will Flash for 3 seconds	N/A
LCD Test	Local LCD screen will cycle 5 solid colours and return to the Test Menu	N/A
Buzzer Test	Local Repeater Buzzer will activate for 3 seconds	N/A
Silence Buzzer	Silence active Local buzzer and Max control panel buzzer(s) including all Networked panels	N/A
Silence Sounders	Silence active sounders on Max control panel(s), including all Networked panels	22222
Resound Sounders	Resound silenced sounders prior to reset on Max control panel(s), including all Networked panels	22222
Reset	Reset active alarms and events on Max control panel(s), including all Networked panels	22222



Default Level 2 [22222], Level 3 [33333]. Passcodes for access above Level 1 may be pre-defined at the Max Fire Control panel. Please refer to the Max commissioning manuals for details on passcode changes. Repeater passcodes cannot be changed and are defined by the Max control panel.

## 3 Technical Characteristics

- Display 7"/17.78 cm wide TFT RGB 800 x 480 with resistive touchscreen with LED backlight. Active area 152.5 mm x 91.44 mm with anti-glare treatment.
- Communication Medium:
  - RS485 2-wire serial link
- Connections:
  - 2 core power
  - 2 core serial line (2 core + Shield/GND)
- Power supply:
  - 11 Vdc to 30 Vdc max (polarity inversion protection)
- Current consumption:
  - Quiescent state 73 mA at 24 Vdc
  - In Alarm/Fire state 130.6 mA at 24 Vdc
- Mechanics:
  - Dimensions (L x H x D): 220.7 x 132.7 x 37.7 mm
  - Weight: 500 g
  - Degree of protection: IP 30
  - Operating temperature: -5°C ... +50°C
  - Storage temperature: -10°C ... +60°C
  - Relative humidity: Max. 95 % (non-condensing)
  - RAL: Plastic Body (RAL9002), Gloss Frame (RAL7035)
  - Terminals: Max Wire gauge for terminals: 0.5 mm<sup>2</sup> to 2.5 mm<sup>2</sup>

### 3.1 Dimensions

L/H/D 220.7 x 132.7 x 37.7 mm. Dimensions include Easy Fix Plate.

Front

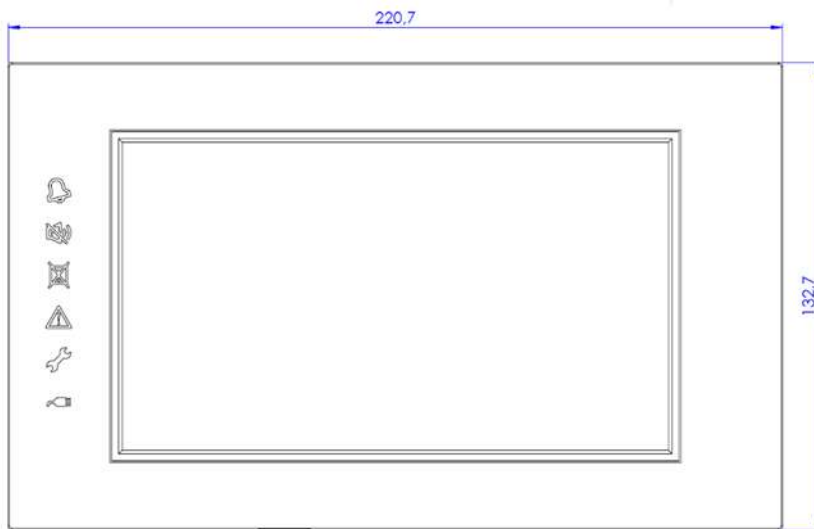

Side



### 3.2 LED Symbol Indication

The MA-LCD7 includes 6 status symbols illuminated by LED indicating Panel and Network status. The LED symbols are located on the left side of the touchscreen display. Each indicator will illuminate repeating the panel and or Network condition and LCD Local power status.

	RED:	Fire Alarm LED Indicator. Active Fire Alarm Event
	Flashing:	Fire Alarm not acknowledged. Solid: Fire Alarm acknowledged.
	YELLOW:	Sounder Silence LED Indicator. Fire Alarm Sounders Silenced.
	Solid:	Sounders Silenced
	YELLOW:	Active disablement(s)
	Solid:	Disablements including System, Zones and or Points
YELLOW:	Fault LED Indicator. Fire Alarm Sounders Silenced.	
Flashing:	Fault not Acknowledged. Solid: Fault Acknowledged.	
YELLOW:	Zone Test Mode	
Solid:	Zone assigned to test mode	
GREEN:	Power Status	
Solid:	Unit receiving Power	



Silence Buzzer is also used for event acknowledgement. Silence buzzer and event acknowledgements are both recorded in the system event history.

## 4 Installation

The MA-LCD7 comes complete with an 'Easy Fix Plate'. This fixing plate allows for installation directly on to the wall (surface mount) or to a recessed or surface mounted single or double electrical back box. After the installation of the Easy Fix Plate the MA-LCD7 can be installed on to the Plate.

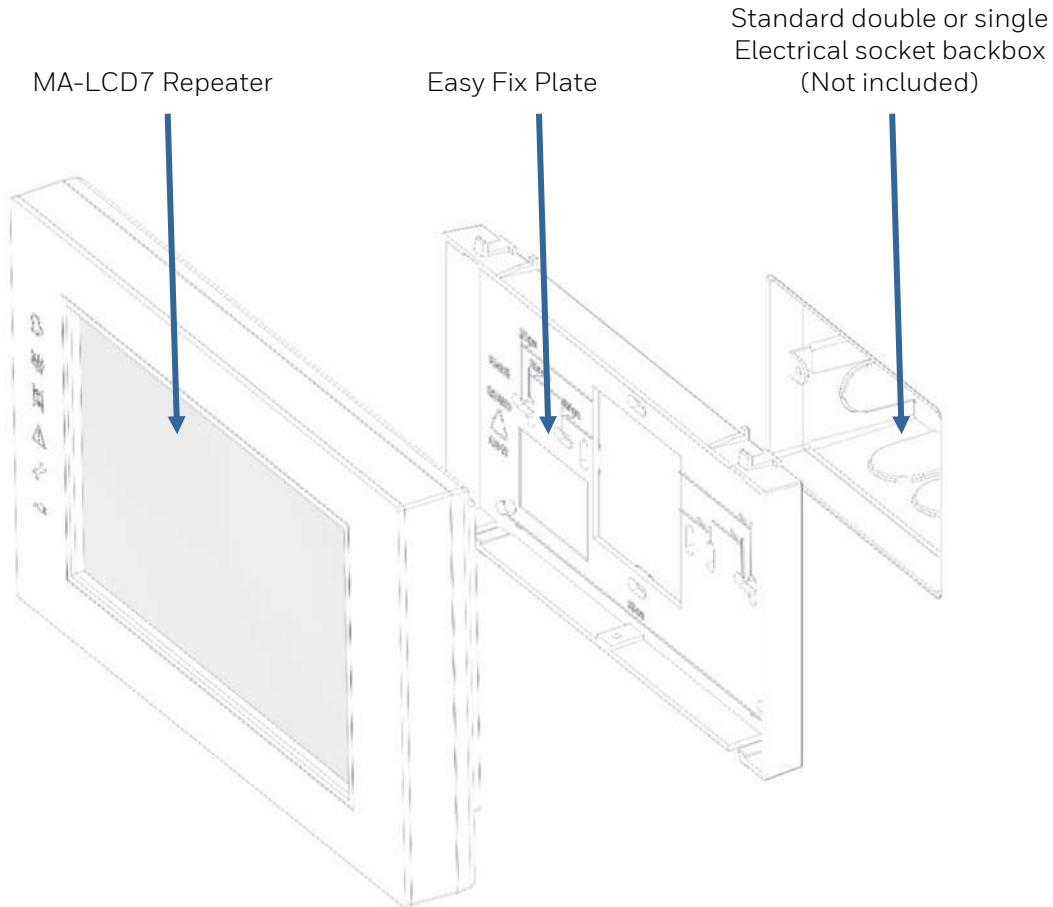

The Easy Fix Plate includes many different mounting holes to suit most single or double electrical back boxes. The Plate also includes standard wall mounting holes.

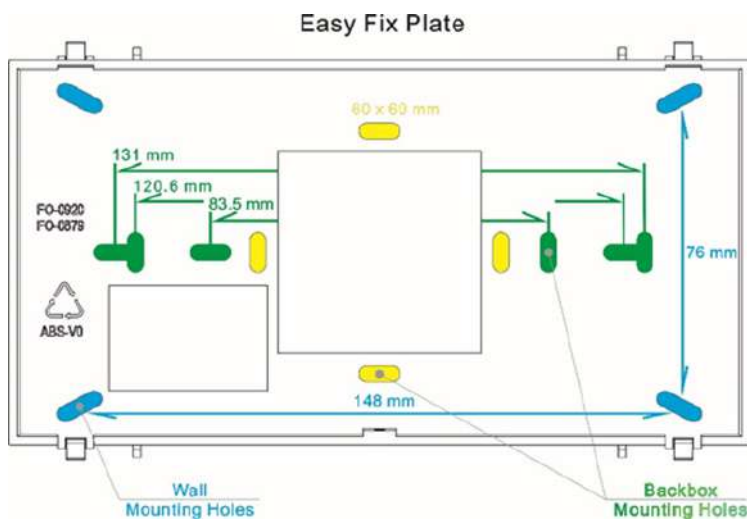

MA-LCD7 must be installed according to the Local regulatory guidance. Please ensure the Repeaters are installed at a minimum of 1.5 m from the floor.

## 4.1 Steps for Installation

Install the Easy Fix Plate to a wall or to an electrical backbox. Route the data and power cables through the large cable entrance in the centre of the fixing plate.

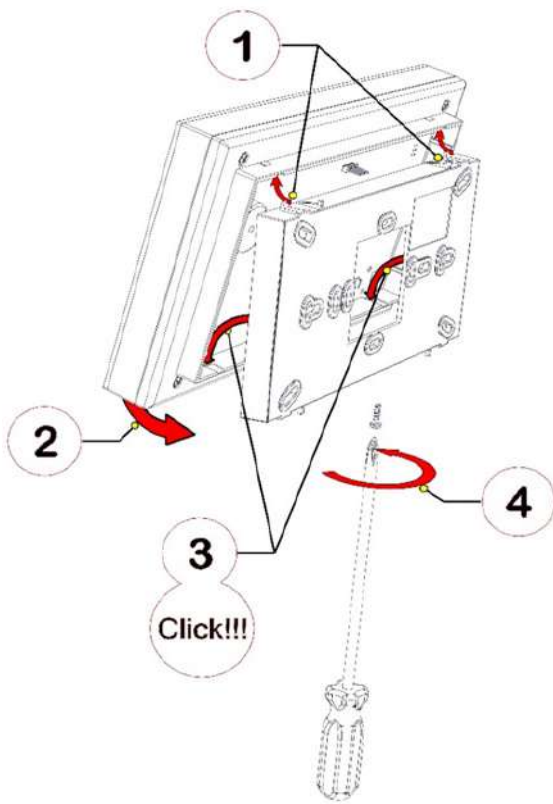

1. Locate the 2 top fixing pins on the fixing plate into the MA-LCD7.
2. Push the MA-LCD7 into the 2 lower clips.
3. An audible click should be heard as the lower clips lock into place.
4. Screw in the locking screw to secure the MA-LCD7 to the plate.

## 4.2 Serial Data & Power Connections

Connections for the serial RS485 and power supply are located on the terminal connector block at the back of the MA-LCD7, in the centre of the PCB. This can be accessed by removing the Easy Fix Plate (if already installed). The cables can be routed through the large cable entry on the Plate.

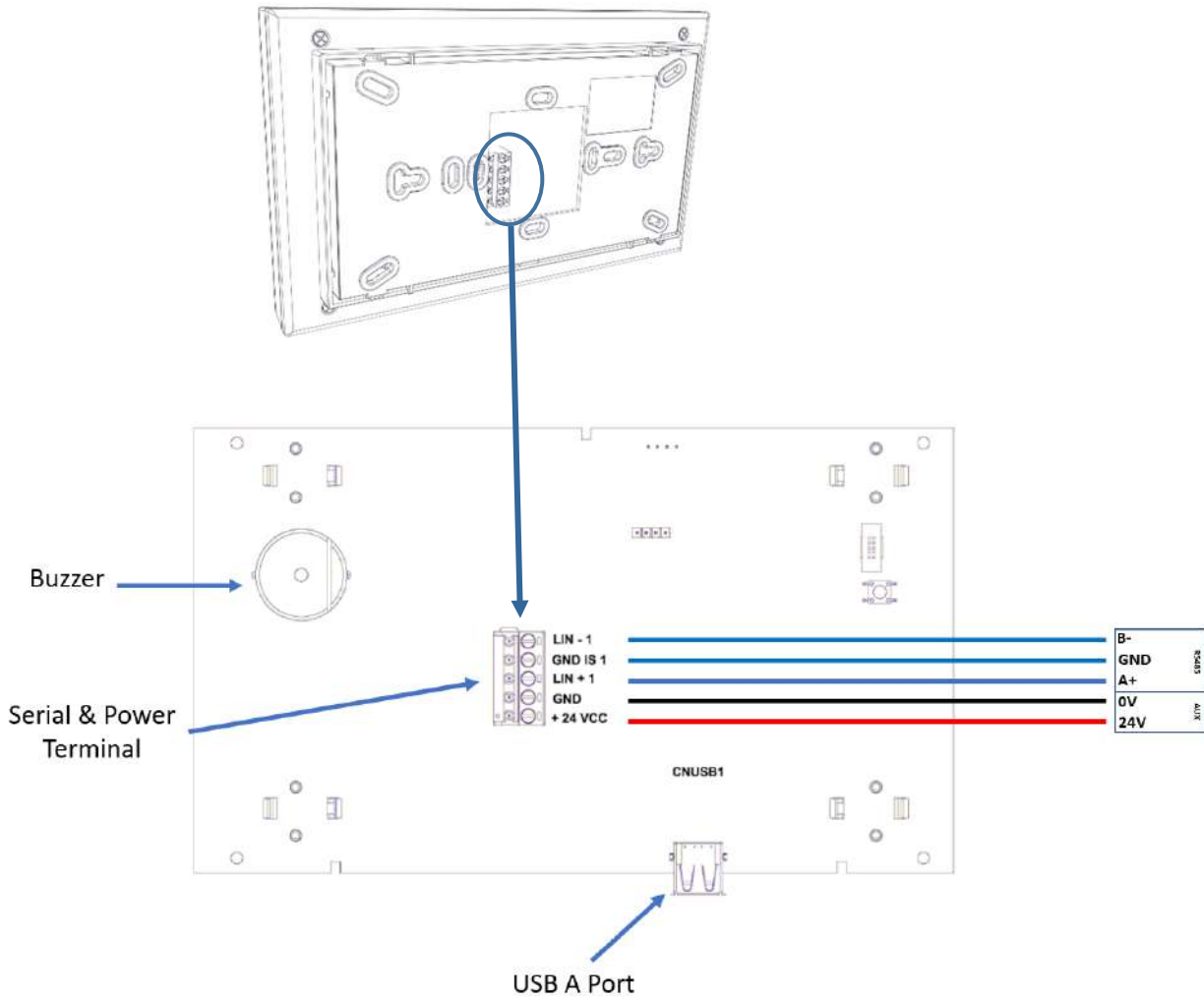

### 4.3 Connection to the Max Panel

MA-LCD7 connects to a single Max panel via an RS485 serial line. Up to 16 MA-LCD7's can be connected via the RS485 Serial line on a single panel. The power supply can be provided by the Max panels 24 V aux (1 ampere) contacts. External power supplies can also be used to power multiple MA-LCD7.

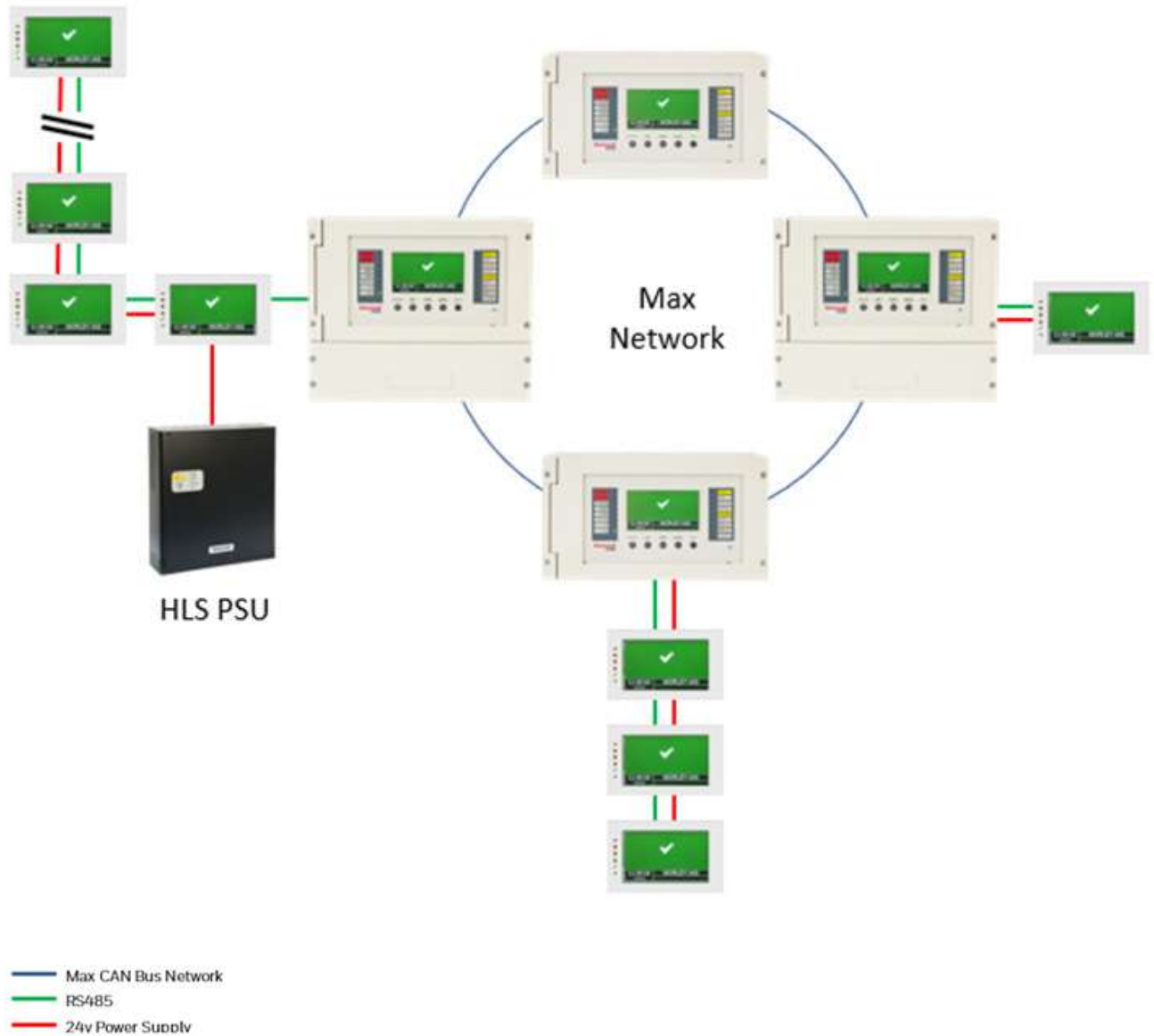

Please note the MA-LCD7 consumption when connecting the power via the panel or an external power supply unit. Do not exceed the rated maximum ampere for the outputs.

### 4.3.1 Connection to MA-1000

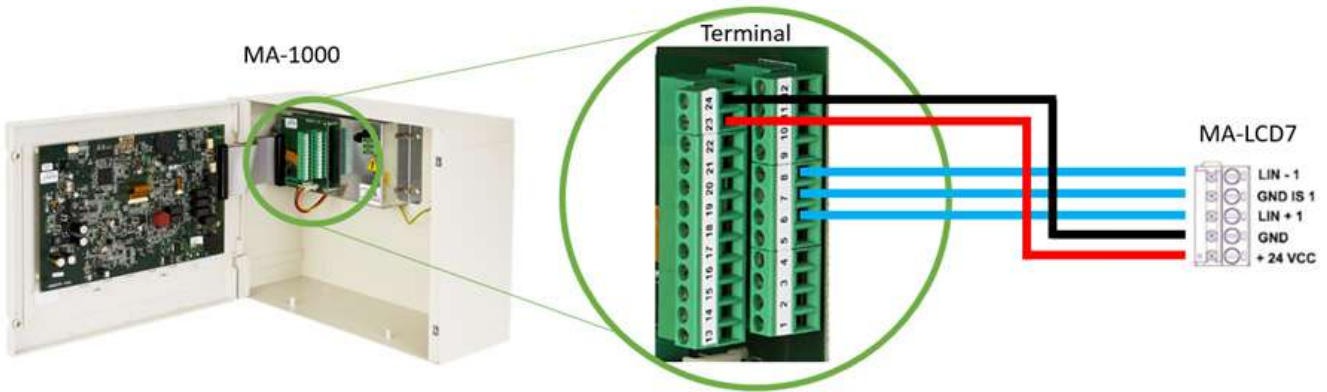

CNU – RS485 connections & 24 V Aux Supply – M-167.1-MA1000-EN Installation Manual.

06	RS485H1	RS485-1 signal A+	Isolated serial RS485-1
07	GNDIS1	GND RS485-1 isolated	
08	RS485L1	RS485-1 signal B-	
23	+24 V USR	+24 VCC User	Aux Supply
24	GND USR	GND User	Protected with 1 A resettable electronic fuse

### 4.3.2 Connections to MA-2000 & MA-8000

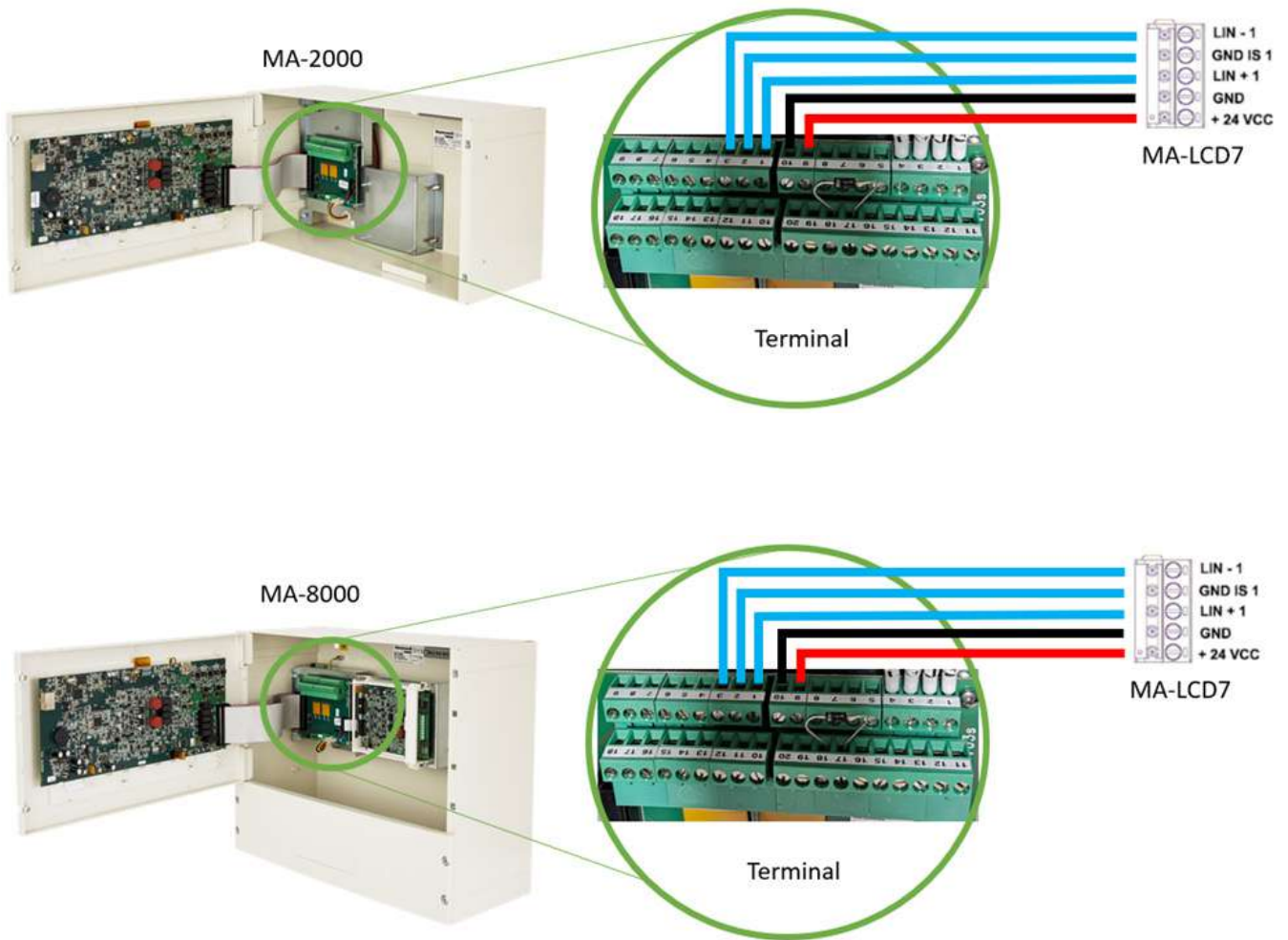

CNS – RS485 connections – M-167.1-MA2000/8000 Installation Manual

01	RS485H1	RS485-1 signal A+	Isolated serial RS485-1
02	GNDIS1	GND RS485-1 isolated	
03	RS485L1	RS485-1 signal B-	

CNU – 24v Aux supply

09	+24 V USR	+24 VCC User	Aux Supply Protected with 1 A resettable electronic fuse
10	GND USR	GND User	

### 4.3.3 Daisy chain' Configuration

Multiple MA-LCD7 Repeaters and/or Mimics can be installed in a 'daisy-chain' configuration on the same serial line. This requires the serial data and/or the power supply to be connected in the same terminals (doubled up) on the MA-LCD7 terminal block. Up to 16 Repeaters or Mimics can be connected to a single panel in any combination. The use of an external power supply may be required if the total alarm current of all MA-LCD7's exceed the maximum current of the auxiliary supply from the Max control panel.

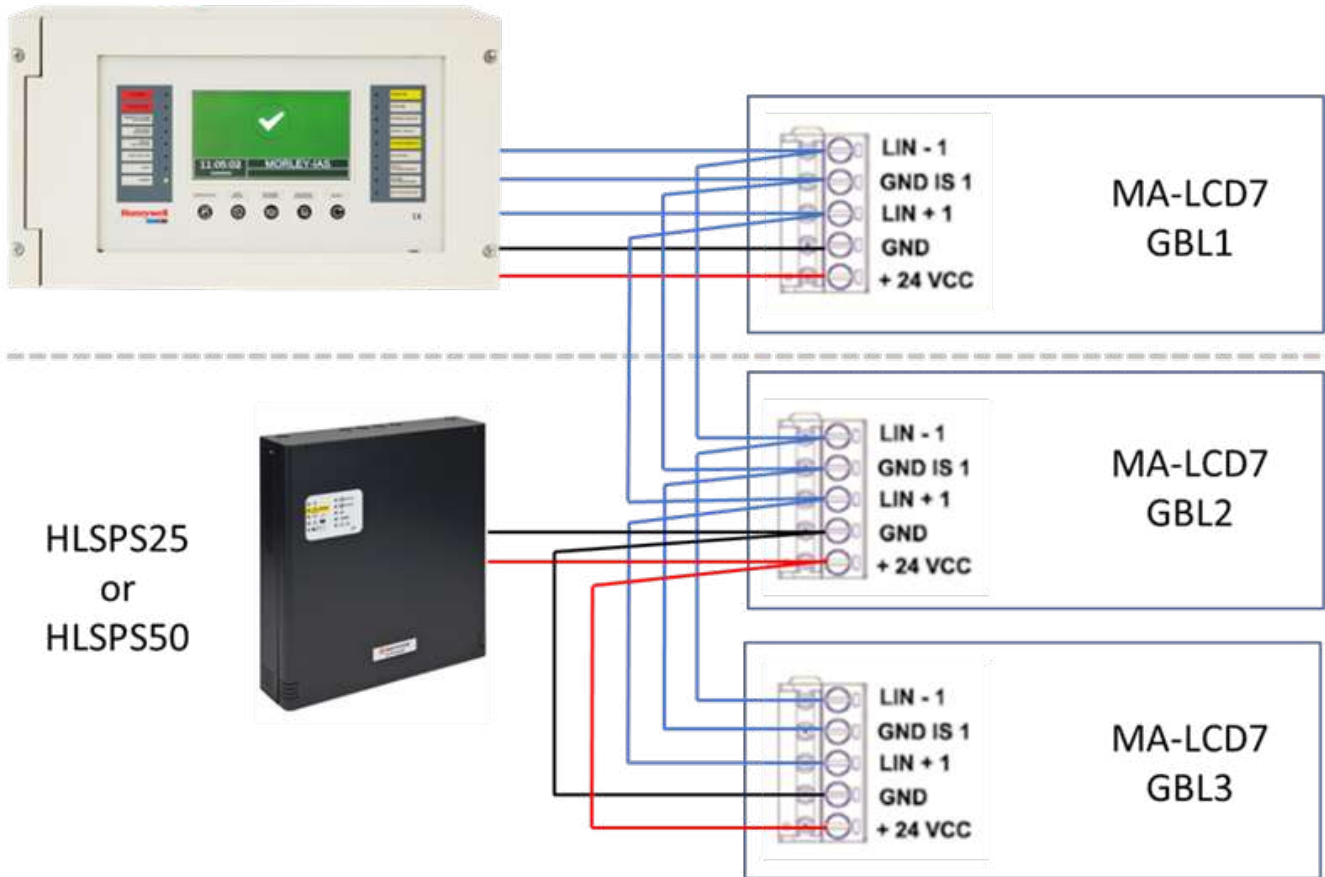

Please ensure each MA-LCD7 is given a unique address (1-16), when connected to the same serial line on a single CPU/Panel. Repeater addresses are indicated on the Max control panel as GBLxx. Double addresses will result in communication errors.



Please ensure the maximum alarm current of the MA-LCD7 does not exceed the maximum control panel 24 V auxiliary supply or external power supply unit (PSU) output rating. Exceeding the alarm current consumption may result in damage to the power supply unit.

## 5 MA-LCD7 Programming

MA-LCD7 can be programmed to function as a Repeater or as a Zonal Mimic. As default, the MA-LCD7 will be supplied pre-programmed to operate as an active Repeater (MA-LCD7). Option to program as virtual zonal Mimic (MA-LCD7M) must be done during the Firmware upgrade process. Upgrading or re-flashing the firmware provides the option to select the MA-LCD7 function.

The Repeater/Mimic firmware is available to download from the following URL:  
<https://buildings.honeywell.com/gb/en/lp/morleymaxtech>



A USB flash drive with a memory size greater than 500 MB is required as part of the firmware upgrade process. A single MA-LCD7 firmware file (.UPD) contains both Repeater (MA-LCD7) and Zonal Mimic (MA-LCD7M) functionality. Each function is selected on the MA-LCD7 upon start up. After selection the MA-LCD7 will reboot in the selected functionality.

### 5.1 Steps for Programming Repeater/Mimic function

1. Download the latest MA-LCD7 Firmware file (.UPD) and add the file to your USB drive.
2. Ensure MA-LCD7 is powered up (if not already).
3. Select [UTIL] Menu button.
4. Select the 'Update Firmware' option.
5. Insert the USB flash drive into the USB port, located at the bottom of the MA-LCD7.
6. Confirmation box will appear. Select 'OK'.
7. MA-LCD7 will now power down and reboot displaying the function selection screen.
8. Select the MA-LCD7 function:
  - a. MA-LCD7 = Functional Repeater
  - b. MA-LCD7M = Zonal Mimic
9. After selecting the function, the MA-LCD7 will reboot again and start up in the selected function.
10. Remove the USB flash drive.

## 6 MA-LCD7 Addressing

Each MA-LCD7 must be programmed with a unique address between 1-16. Addresses can be repeated throughout a Networked system, but not on the same serial line.

As default, all Repeaters/Mimics will be addressed as '0', Users are required to change the address between 1-16 upon start up. If more than one MA-LCD7 is required on the same serial line, then the address of the new MA-LCD7 Repeater must be programmed.

To program the MA-LCD7 address. This option is located in the Utility Menu (access Level 2 required).

### Utility> Address

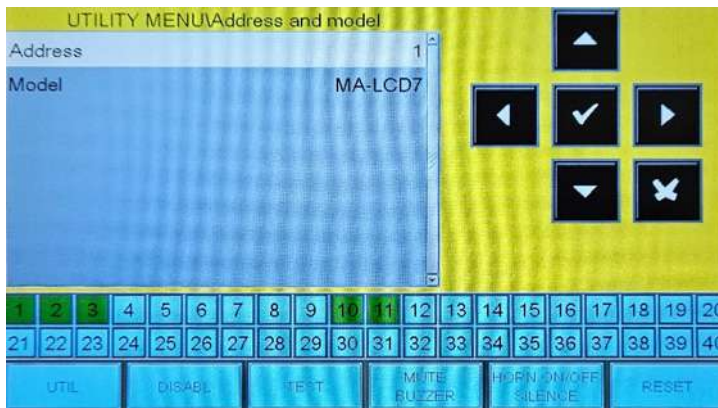

Use the arrow keys ▲▼ to select the option for Address.

Select the address number by pressing the enter key .

Use the arrow keys ▲▼ to select the MA-LCD7 address between 1 – 16.

To confirm the selected address, press the enter key .

### 6.1 MA-LCD7M Mimic Addressing

MA-LCD7 programmed as a Mimic (MA-LCD7M). The address of the mimic also programs the zonal range to be displayed. 1 – 1120. Please see table below.

MA-LCD7M Address	Mimic Zonal Range
1	1 - 80
2	81 - 160
3	161 - 240
4	241 - 320
5	321 - 400
6	401 - 480
7	481 - 560
8	561 - 640
9	641 - 720
10	721 - 800
11	801 - 880
12	881 - 960
13	961 - 1040
14	1041 - 1120

The following addresses are reserved for the MA-LCD7-MOD (MA-8000 only) Starting range from 41.

15	41 - 120
16	121 - 200

## 7 Panel Programming

After programming the MA-LCD7 with function and address. The Max control panel must be programmed with each active Repeater or Zonal Mimic connected. Each Max control panel can support up to 16 addresses. Each MA-LCD7 can be given a unique address label (up to 32 characters) for identification and location purposes. When Repeaters are programmed on the panel, the Max control panel will monitor each Repeater/Mimic and report the loss of communication or Fault condition. A Fault message is displayed on each Max control panel, this includes the MA-LCD7 address label and address number (GBLxx) being displayed.

### PROG>Program>LCD RPT

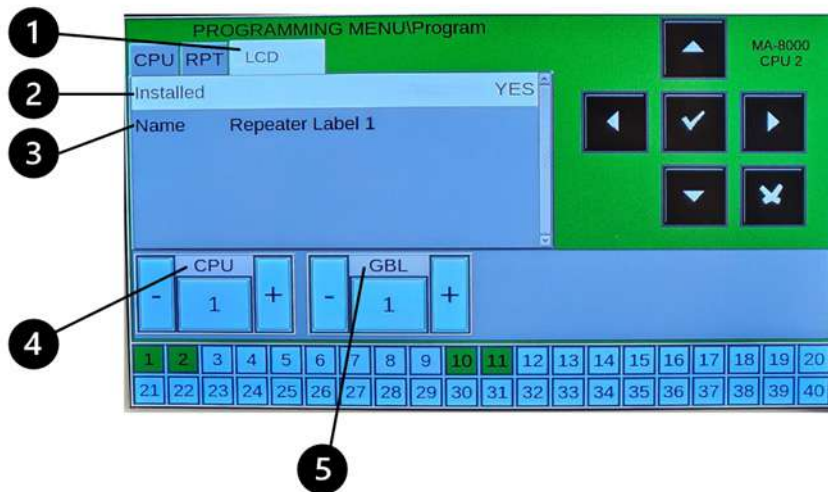

Use the arrow keys  $\leftarrow$   $\rightarrow$  to navigate to the 'LCD' tab **1**.

Select the CPU/panel number **4** and the Repeater address **5**.

Select the  $\checkmark$  enter key to edit the installed status.

Use the arrow keys  $\uparrow$   $\downarrow$  to toggle between Yes/No. Select 'YES' by using the enter key  $\checkmark$ .

Use the arrow keys  $\uparrow$   $\downarrow$  to select the name option and

press the enter key  $\checkmark$ . A QWERTY keyboard will be displayed to label entry.

- |   |   |
|---|---|
| ① | MA-LCD7 Tab $\rightarrow$ Installed $\rightarrow$ Name/Label<br>Displays all LCD Repeaters on Network or Local  |
| ② | Select the $\checkmark$ and use the arrow keys to toggle between Yes or No, to program the active address on the CPU and GBL<br>In this example, CPU 1 GBL (Repeater) 1, installed = Yes. Repeater address 1 is active on CPU 1 |
| ③ | Name/Label. Use the arrows to navigate to the label line. Press the Enter key $\checkmark$ . A full QWERTY keyboard appears to allow label entry. Up to 32 characters   |
| ④ | CPU (Central Processing unit/Panel number)<br>Use the +/- to select the CPU/Panel number or select the number box $\boxed{1}$ and enter the desired address. Selectable from 1-64 CPUs  |
| ⑤ | GBL (Global) Repeater number.<br>Use the +/- to select Repeater addresses 1-16 or select the number box $\boxed{1}$ and enter the desired address   |



MA-LCD7 can be programmed via any panel on a Network. Users MUST select the correct CPU (Panel) and GBL (Repeater) number and ensure the Repeater is programmed to the correct address first before changing activation status to 'YES'.

## 8 MA-LCD7 Menu options & user Interface

Screen layout and events will differ depending on the MA-LCD7 programming. Only the Menu option [UTIL] utility will remain the same on both Repeater (MA-LCD7) and Zonal Mimic (MA-LCD7M).

Repeat (MA-LCD7)

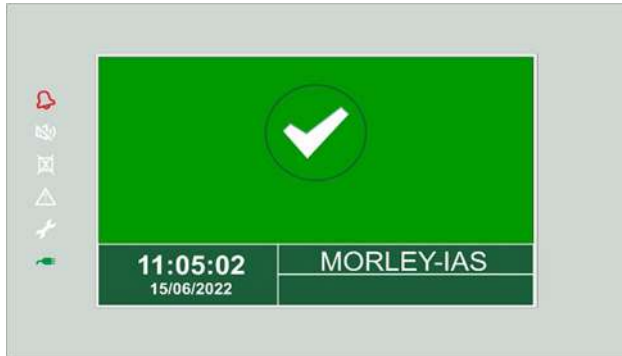

Mimic (MA-LCD7M)



### 8.1 MA-LCD7 Repeater & Mimic - Menu options

The MA-LCD7 Repeater provides 3 Menu options via the virtual keys.

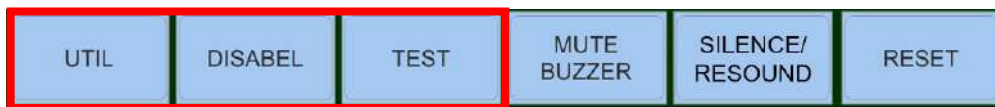

The MA-LCD7M Mimic provides only the Utility Menu option via the virtual keys.



#### 8.1.1 MA-LCD7 Repeat and MA-LCD7M Mimic 'UTIL' Utility Menu

The Utility Menu option opens to a new sub-menu, which includes six additional options.

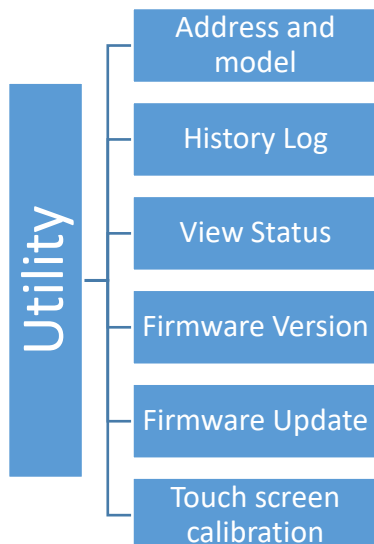

### Address and model

The Address and Model Menu provides the option to define the MA-LCD7 address number and to view or change the model of the Repeater. MA-LCD7 is programmed as Address GBL-01 and Model MA-LCD7 as default.



- ① Address – Selecting the address option using the selection key . Using the arrow keys , select the MA-LCD7 address between 1:16. To confirm the selected address, press the selection key .
- ② Model – Use the arrow keys to select model. When programmed as a Repeater the is 'MA-LCD7'. When programmed as a Zonal Mimic, the option is 'MA-LCD7M'. Use the selection key to select the model.









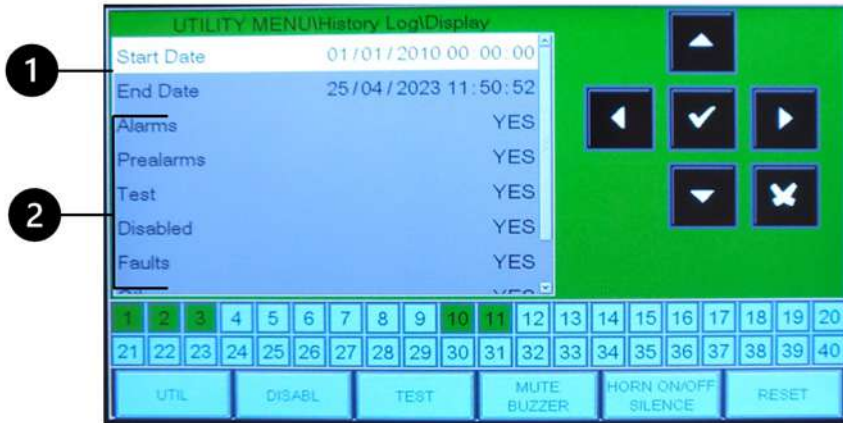





### History Log



- ① Events/Size – Event size displays the total event log capacity. Current Events/Maximum events = 10,000 Event count is total events on the Panel or Networked system.
- ② Using the arrow keys to navigate to the Display option – use the select key to open the display Menu. The display option will open the event display screen.
- ③ Using the arrow keys to navigate to the Save History Log option - use the select key to export the entire event history to a connected USB flash drive.

The display menu provides options for users to filter the events to be displayed.



- ① Start/End date and time - Using the select key  select the start date/time. Once selected use the   to edit the start date DD/MM/YYYY. Press the select key again  to confirm entry. Use the arrow keys   to select the time (24h format) HH/MM/SS. Press the select key  to confirm the entry. The same method is used to select the end date and time.
- ② Event filter options (Alarms, Pre-Alarms, Test, Disabling, Faults and Other). Option: Yes = event will be displayed. No = Event will not be displayed. Using the arrow keys  , select the options to be filtered in the event display. Use the select key  to events and then arrow keys   to toggle options: YES/NO.
- ③ Display - Using the arrow keys  , navigate to the Display button and press the select key . The events will be displayed between the start/end date and time excluding filtered event 'NO' events.

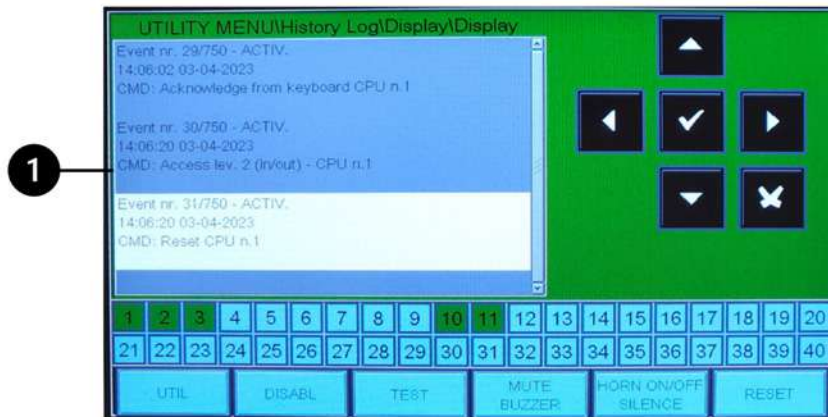

- ① All events are displayed in order (Start date/time to End date/time) from the top down. Use the arrow keys ▲▼ to scroll through all events. To exit the event display screen, select the escape key ✕.

The option 'Save History Log' will export all events to a USB flash drive connected to the MA-LCD7. If no USB flash drive is detected, an instructional message will display 'Insert USB key...'.



If a USB flash drive is detected, the event export will start. Once complete, the MA-LCD7 will display 'Write on USB key completed' – The USB flash drive can now be removed.









A .TXT file is now saved to the USB flash drive. Users can open the .TXT file and view the events in order of occurrence.

EVENT	RESET Activation output module C1L1M3 (STR): Strobe Z1:	16:47:29 17-04-23
CMD	RESET Access lev. 2 (in/out) MA-LCD7 n.1 C2 TEST REPEAT 2	16:47:29 17-04-23
EVENT	RESET Activation output module C2L3M1 (STR): CPU 2 STR Z10:	16:47:29 17-04-23
CMD	ACTIV. Access lev. 2 (in/out) MA-LCD7 n.1 C2 TEST REPEAT 2	16:48:56 17-04-23
CMD	ACTIV. Access lev. 2 (in/out) MA-LCD7 n.1 C2 TEST REPEAT 2	16:48:56 17-04-23
CMD	ACTIV. Reset MA-LCD7 n.1 C2 TEST REPEAT 2	16:48:57 17-04-23
EVENT	ACTIV. Panel in normal status	16:48:57 17-04-23
CMD	RESET Access lev. 2 (in/out) MA-LCD7 n.1 C2 TEST REPEAT 2	16:48:57 17-04-23

### View Status

The View Status Menu enables users to view the current status of Devices, Modules and Zones connected to the panel or Networked system.



- ① Detectors - Press the select key  to select the Detector option. View status Detectors will enable users to view the status of all detectors connected on a panel or Networked system.
- ② Modules - Use the arrow keys   to select the module option. Press the select key  to select the module option. View status Module will enable users to view the status of all modules connected on a panel or Networked system.
- ③ Zones - Use the arrow keys   to select the Zones option. Press the select key  to select the Zones option. View status Zones will enable users to view the status of all Zones on a panel or Networked system.

View status **Detectors** screen will display the current status of all detectors learnt. Users are able to select the 'CPU' panel, 'Line' loop, and detector number.

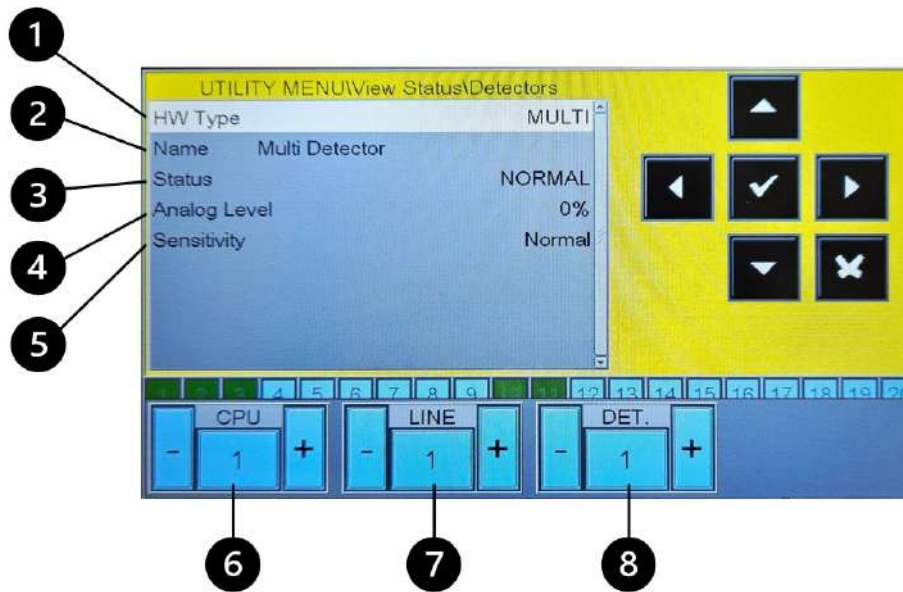

- ① HW Type – Displays the device hardware type ID (ION, MULTI, PHOT, PINN, THER)

---

- ② Name – Displays the device address label (up to 32 characters)

---

- ③ Status – Displays the current devices status (NORMAL, ALARM, PRE-ALARM, DISABLED, FAULT)

---

- ④ Analog Level – Displays the current analogue value. Value displayed as %

---

- ⑤ Sensitivity – Displays current sensitivity. Sensitivity levels programmable for each device ID.

---

- ⑥ CPU (Central Processing Unit/Panel Number)  
Use the +/- to select the CPU/Panel number or select the number box  and enter the desired address. Selectable from 1-64 CPUs.

---

- ⑦ LINE (Loop or Line Number)  
Use the +/- to select the Loop/Line number or select the number box  and enter the desired address. Selectable from 1-8 Loops.

---

- ⑧ DET. (Detector Number)  
Use the +/- to select the Detector number or select the number box  and enter the desired address. Selectable from 1-99 addresses.

View status **Module** screen will display the current status of all modules learnt. Users are able to select the 'CPU' panel, 'Line' loop, and module number.

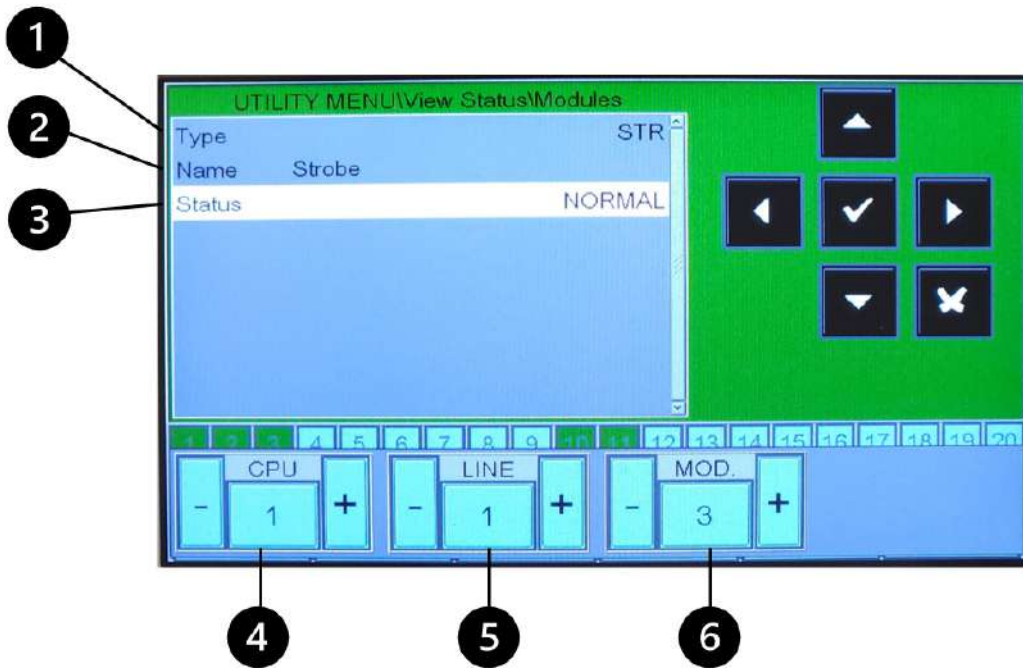

- ① HW Type – Displays the device hardware type ID (See Commissioning manual M-167.2 SERIE-MA-EN/112021 for Module HW device ID details)

---

- ② Name – Displays the module address label (up to 32 characters)

---

- ③ Status – Displays the current module status (NORMAL, ACTIVATED). Users are not able to 'activate' output devices from the MA-LCD7. View only option from this screen.

---

- ④ CPU (Central Processing unit/Panel Number)  
Use the +/- to select the CPU/Panel number or select the number box  and enter the desired address. Selectable from 1-64 CPUs.

---

- ⑤ LINE (Loop or Line Number)  
Use the +/- to select the Loop/Line number or select the number box  and enter the desired address. Selectable from 1-8 Loops.

---

- ⑥ MOD. (Module Number)  
Use the +/- to select the Module number or select the number box  and enter the desired address. Selectable from 1-99 addresses.

View status **Zones** screen will display the current status of all Zones. Users are able to select the 'ZONE' number.

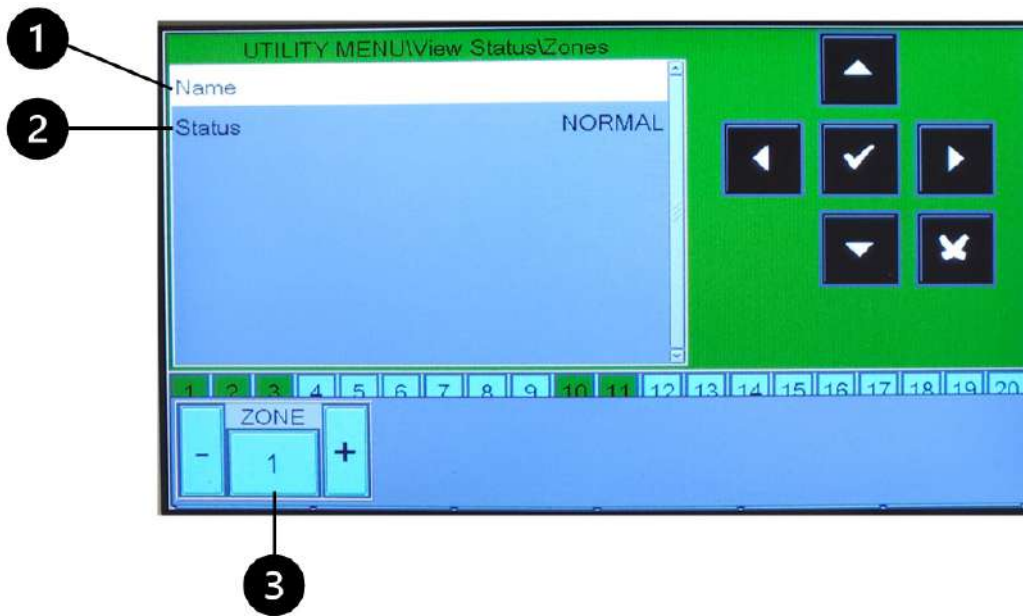

- ① Name – Displays the Zone Label (up to 32 characters)

---

- ② Status – Displays the current Zone status (NORMAL, ACTIVATED).

---

- ③ ZONE (Zone Number)  
 Use the +/- to select the Zone number or select the number box  and enter the desired address.  
 Selectable from 1-2000 Zones

**Firmware Version**

The MA-LCD7 Firmware version is displayed within the Utility Menu.



① Name – Displays the Zone Label (up to 32 characters)

**Firmware Update**

The MA-LCD7 may require firmware upgrades throughout its serviceable lifetime. This can be for implementing additional features and/or bug fixes. The firmware upgrade is a quick and easy process. A single .UPG file will be available to upload to the MA-LCD7 via a USB flash drive. Once uploaded, users can select the MA-LCD7 functionality: [MA-LCD7] Active Repeater or [MA-LCD7M] Zonal Mimic.

Firmware for the MA-LCD7 is available to download from the Morley-IAS Max technical webpage: <https://buildings.honeywell.com/gb/en/lp/morleymaxtech>

## Touchscreen Calibration

While touchscreens are designed to function reliably, occasional recalibration may be necessary due to a number of factors. The MA-LCD7 has a recalibration process to realign input responses. Selecting the 'Touchscreen Recalibration' Menu will initiate the recalibration process. Follow the on-screen prompts to complete the calibration process. Once completed, an on-screen message will display 'Touchscreen Recalibration Complete' and then automatically return to the previous menu screen.

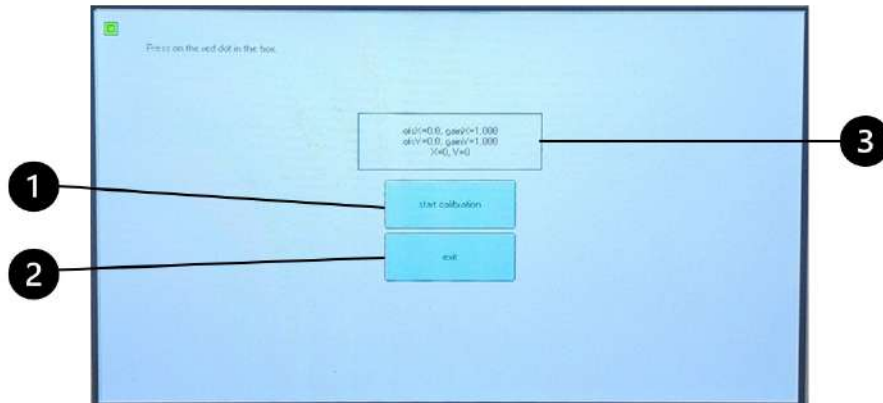

- |   |  |
|---|--|
| ① | Start Calibration – Selecting this option will initiate the recalibration process. Once selected, follow the on-screen instructions to complete the recalibration process.             |
| ② | Exit – Selecting this option will exit the recalibration screen and return to the Utility Menu. Once the recalibration is complete, select exit to complete the recalibration process. |
| ③ | Axis Display - X & Y data will be displayed during the recalibration. Default '0' = no entry.  |

### 8.1.2 LCD7 Repeater - 'DISABL' Disablement Menu



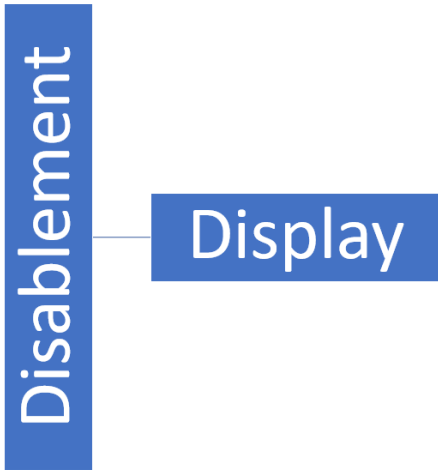





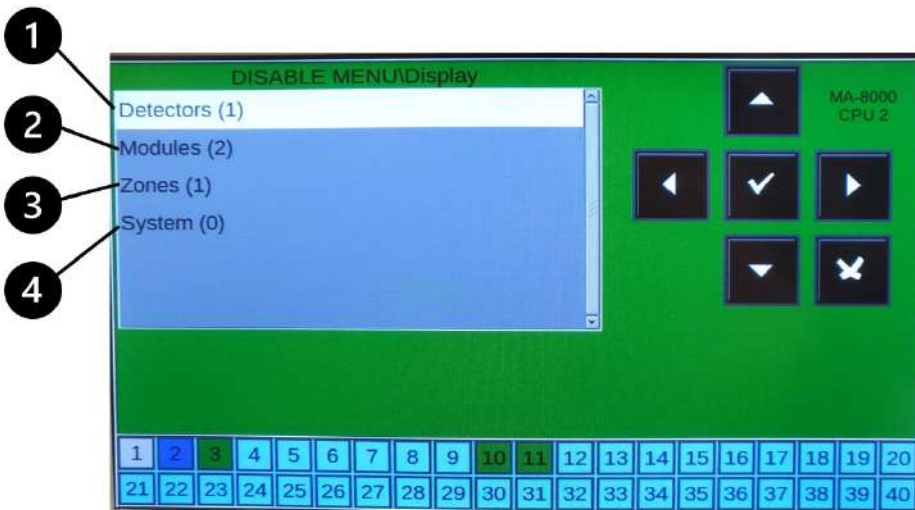

The Disablement Menu has only one sub-menu to select. The MA-LCD7 functions are view-only. A user can view active disablements. Users can not initiate a disablement from the MA-LCD7. This menu option is not available when MA-LCD7 is programmed as a MA-LCD7M Virtual Zonal Mimic.



#### Display

The Display Menu provides a summary of all active disablements on a panel or Networked system. The summary displays Detectors, Modules, Zones and System disablements. Each summary is selectable and will provide details on each device or system that are disabled.



- ① Detectors – Displays the total number of devices that are currently disabled on a panel or Networked system. Press the select key  to select the Detector option. The Detector option will enable users to view all disabled detector(s).
- ② Modules – Displays the total number of modules that are currently Disabled on a panel or Networked system. Use the arrow keys   to select the modules option. Then press the select key  to select the module options. The Modules option will enable users to view all disabled module(s).
- ③ Zones – Displays the total number of Zones that are currently Disabled on a panel or Networked system. Use the arrow keys   to select the Zones option. Then press the select key  to select the Zones option. The Zones option will enable users to view all disabled Zone(s).
- ④ System – Displays the total number of system/panel disablements that are currently Disabled on a panel or Networked system. Use the arrow keys   to select the System option. Then press the select key  to select the System option. System option will enable users to view all disabled System option(s).

Selecting each summary will provide details on the devices, modules, or system disablements. This option displays the CPU Number, Loop Number, Point Address and Point Label.



- ① Disabled Module Details – ‘**C1L1M1 (PULL) (Zone n.1 – Label for Zone 1)**’  
 Location of device/address – [**C1L1M1**] = Alarm **C1**=CPU/Panel number 1, **L1**= Loop Number 1, **M1** = Module address 1. [(**PULL**)] device type ID = PULL or MCP (Manual Call Point), Assigned Zones details and Zone Label = [**Zone n.1 – Label for Zone 1**]  
 Device Label – ‘MCP Label’  
 Use the arrow keys ▲▼ to scroll if more than 5 devices are listed.

---

- ② Disabled Module Details – ‘**C1L1M3 (STR) (Zone n.1 – Label for Zone 1)**’  
 Location of device/address – [**C1L1M3**] = Alarm **C1**=CPU/Panel number 1, **L1**= Loop Number 1, **M3** = Module address 3. [(**STR**)] device type ID = Strobe (General Sounder), Assigned Zones details and Zone Label = [**Zone n.1 – Label for Zone 1**]  
 Device Label – ‘Strobe Label’

### 8.1.3 MA-LCD7 Repeat - 'TEST' Test Menu

The Test Menu has four options to select: 'Zone', 'LED', 'LCD' and 'Buzzer'. LED, LCD and Buzzer are internal function tests that will test the MA-LCD7's internal LED (LED symbol indicators), LCD (screen pixel color test), and Buzzer (internal buzzer audible test). The TEST option displays the current Zone in test. This option will not allow users from the MA-LCD7 to initiate Zone Test Mode. This option will display Zone in Test Mode that has been initiated by the Max control panel. This menu option is not available when MA-LCD7 is programmed as a MA-LCD7M Virtual Zonal Mimic.

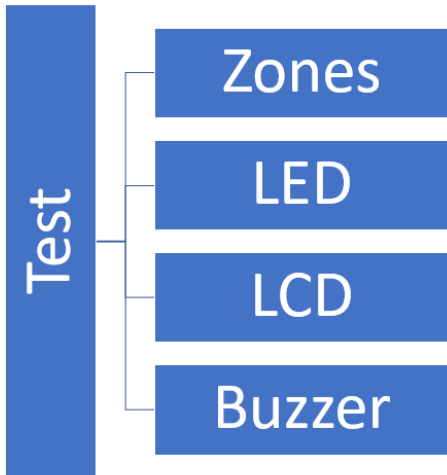

#### Zones, LED, LCD & Buzzer



- ① Zones – Displays the Zone in Test Mode that has been initiated from the Max control panel. Zone Test Mode cannot be initiated from the MA-LCD7. This option is display only. Press the select key to select the Zones option.
- ② LED – This option initiates the Local LED test. The LED status symbols will illuminate for 3 seconds and returns to the previous state. Use the arrow keys to select the LED option. Then press the select key to initiate the Local LED test.
- ③ LCD – This option initiates the Local LCD test. The LCD Screen will cycle solid colours and returns to the test Menu. Use the arrow keys to select the LCD option. Then press the select key to initiate the Local LCD test.
- ④ Buzzer – This option initiates the Local Buzzer test. The Buzzer will be active for 3 seconds and then turns off. Use the arrow keys to select the Buzzer option. Then press the select key to initiate the Local Buzzer test.

## 8.2 MA-LCD7 USER INTERFACE

The MA-LCD7 utilises Max control panel's unique User Interface. Similar menus, navigational controls and colour-coded event background and Zonal Indicators enables a simple and easy to use menu, event identification and usability when using the MA-LCD7. The MA-LCD7 can be programmed as a Repeater (Default) or a Virtual Zonal Mimic MA-LCD7M. Each programmable variant provides a different User Interface to display the events and alarms.

### 8.2.1 Screen Saver (Healthy Status)

Both the MA-LCD7 (Repeater) & MA-LCD7M (Virtual Zonal Mimic) will display the 'Healthy' screen saver when no event or alarm conditions are reported on the system. When an event or alarm is active or when the screen is pressed, the screen saver will be removed, and the screen will display the event tab (Repeater) or Virtual Zonal Indicators (Zonal Mimic) displaying the event condition.



- ① Green Background & Check Icon – The green background and check Icon provides a quick status indication of a 'Healthy' system, meaning no alarms or events are reported on the system. Pressing anywhere on screen will remove the screen saver displaying the main screen and panel menu and controls.
- ② Date and Time – The system data and time is displayed on the screen saver in a 24h format: Time HH/MM/SS, Date DD/MM/YYYY.
- ③ Installation Name – Programming the installation name on the Max control panel will be displayed on the screen saver (up to 20 characters). default: Morley-IAS

## 8.2.2 Virtual Zone Indicators

Whether programmed as a Repeater or Virtual Zonal Mimic, each UI will display Virtual Zones. MA-LCD7 (Repeater) will display Virtual Zones 1 to 40, whereas the Virtual Zonal Mimic will display a total of 80 Zones that are user programmable by selecting the zonal mimic address.

Virtual Zone colour coding. Each Virtual Zone indicator can display up to 7 colour-coded event statuses.

### MA-LCD7 Repeater Virtual Zonal Indicators

1	2	3	4	5	6	7	8	9	10	11	12	13	14	15	16	17	18	19	20
21	22	23	24	25	26	27	28	29	30	31	32	33	34	35	36	37	38	39	40

### MA-LCD7M Mimic Virtual Zonal Indicators

1	2	3	4	5	6	7	8	9	10
11	12	13	14	15	16	17	18	19	20
21	22	23	24	25	26	27	28	29	30
31	32	33	34	35	36	37	38	39	40
41	42	43	44	45	46	47	48	49	50
51	52	53	54	55	56	57	58	59	60
61	62	63	64	65	66	67	68	69	70
71	72	73	74	75	76	77	78	79	80

- Green** → Devices are assigned to Zone – Zone in a ‘Healthy’ event free condition

---

- Yellow** → Devices assigned to the Zone, or the Zone is reporting a ‘Fault’ condition

---

- Amber** → Zone in Pre-Alarm condition

---

- Red** → Zone in Fire/Alarm condition

---

- Light Blue** → Zone has no devices assigned. Zone not in use

---

- Dark Blue** → Zone in Test Mode

---

- Grey** → Zone is Disabled, or all device(s) assigned to Zone are disabled

### 8.2.3 MA-LCD7 Repeater

When programmed as a Repeater (MA-LCD7), typical screen elements are identified below, which aide in the identification of events. As default, the MA-LCD7 will be programmed as a Repeater.

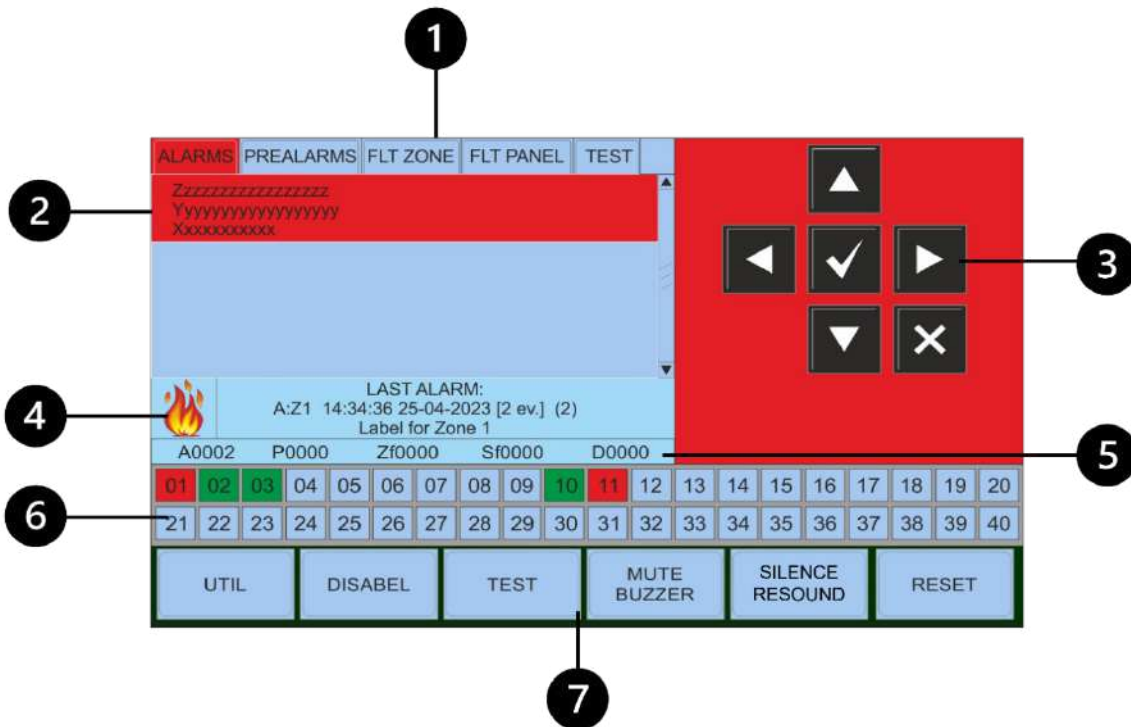

①	<b>Event TABs</b>	Use the Navigational arrows to select each Tab																					
②	<b>Event Window</b>	Event window displays any active events within the selected event Tab																					
③	<b>Navigational Controls</b>	Use these controls to navigate the Tabs and Menu options																					
④	<b>Event Icon and Last Event</b>	Event icons for each event type Last event reported in the Event Tab Menu																					
⑤	<b>Event Summary</b>	A → Alarms, P → Pre-Alarms, ZF → Zone Fault, SF → System Fault, Zone Disablements																					
⑥	<b>Virtual Zonal Indicators (Zones 1-40)</b>	<table border="0"> <tr> <td>RED</td> <td>→</td> <td>FIRE/Alarm</td> </tr> <tr> <td>YELLOW</td> <td>→</td> <td>Zone Fault</td> </tr> <tr> <td>AMBER</td> <td>→</td> <td>Pre-Alarm</td> </tr> <tr> <td>GREEN</td> <td>→</td> <td>Active Zones in 'Healthy' Condition</td> </tr> <tr> <td>GREY</td> <td>→</td> <td>Zone Disabled</td> </tr> <tr> <td>DARK BLUE</td> <td>→</td> <td>Zone in Test</td> </tr> <tr> <td>LIGHT BLUE</td> <td>→</td> <td>Zone not active (no devices assigned to Zone)</td> </tr> </table>	RED	→	FIRE/Alarm	YELLOW	→	Zone Fault	AMBER	→	Pre-Alarm	GREEN	→	Active Zones in 'Healthy' Condition	GREY	→	Zone Disabled	DARK BLUE	→	Zone in Test	LIGHT BLUE	→	Zone not active (no devices assigned to Zone)
RED	→	FIRE/Alarm																					
YELLOW	→	Zone Fault																					
AMBER	→	Pre-Alarm																					
GREEN	→	Active Zones in 'Healthy' Condition																					
GREY	→	Zone Disabled																					
DARK BLUE	→	Zone in Test																					
LIGHT BLUE	→	Zone not active (no devices assigned to Zone)																					
⑦	<b>Virtual Keys:</b>	<table border="0"> <tr> <td>UTIL</td> <td>→</td> <td>Utility Menu - Opens Utility Menu options</td> </tr> <tr> <td>DISABL</td> <td>→</td> <td>Disablement Menu - Opens Disablement Menu options</td> </tr> <tr> <td>TEST</td> <td>→</td> <td>Test Menu - Opens Test Menu options</td> </tr> <tr> <td>MUTE BUZZER</td> <td>→</td> <td>Mutes Buzzer Local and panel buzzers</td> </tr> <tr> <td>SILENCE RESOUND</td> <td>→</td> <td>Silence Sounder / Resound Sounders</td> </tr> <tr> <td>REST</td> <td>→</td> <td>Repeater and Panel Reset - Clears all events</td> </tr> </table>	UTIL	→	Utility Menu - Opens Utility Menu options	DISABL	→	Disablement Menu - Opens Disablement Menu options	TEST	→	Test Menu - Opens Test Menu options	MUTE BUZZER	→	Mutes Buzzer Local and panel buzzers	SILENCE RESOUND	→	Silence Sounder / Resound Sounders	REST	→	Repeater and Panel Reset - Clears all events			
UTIL	→	Utility Menu - Opens Utility Menu options																					
DISABL	→	Disablement Menu - Opens Disablement Menu options																					
TEST	→	Test Menu - Opens Test Menu options																					
MUTE BUZZER	→	Mutes Buzzer Local and panel buzzers																					
SILENCE RESOUND	→	Silence Sounder / Resound Sounders																					
REST	→	Repeater and Panel Reset - Clears all events																					

**MA-LCD7 Repeater Fire**

In the event of a Fire Alarm, the MA-LCD7 will display the Alarm tab listing the Zones in alarm. Using the arrow keys ▲▼ to highlight the Zone and then using the select key ✓, users can view the details of the device(s) in alarm. If more than one device within the same Zone is in alarm, then all devices will be displayed.

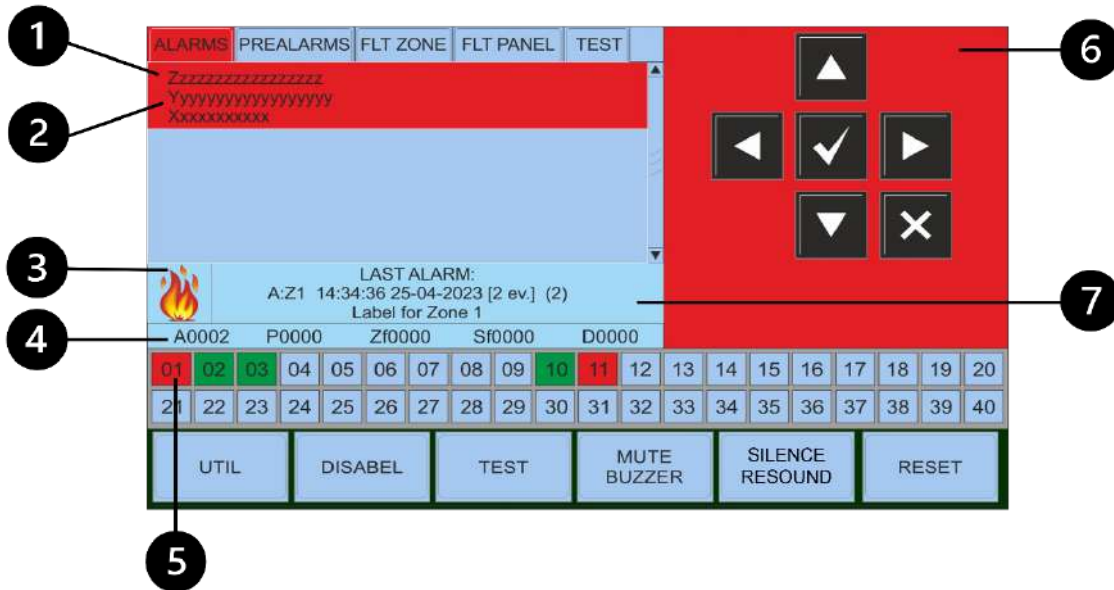

- ① Alarm details – Example: ‘A:Z1 14:31:34 25-04-2023 [1 ev.] (1)’  
 Zone in alarm – [A:Z1] = Alarm Zone 1, [14:31:34 25-04-2023] = Time and Date of activation, [1ev.] = Number of devices in alarm, (1) = Event number  
 To view the device details in alarm Zone, press the select key ✓

---

- ② Zone Label – Displays the Zone Label (up to 32 characters)

---

- ③ Event Icon – FLAME icon Indicates alarm activation.

---

- ④ Event Summary – A0002 = Total number of Zones in alarm

---

- ⑤ Virtual Zonal Indicators – Virtual Zone 1 & 11 displaying Red – Indicates Zone 1 & 11 in alarm condition

---



- ⑥ Background Colour – Red → Alarm condition

---

- ⑦ Last Event – ‘Last Alarm’ - ‘A:Z1 14:34:36 25-04-2023 [2 ev.] (2)’  
 Zone in alarm – [A:Z1] = Alarm Zone 1, [14:34:36 25-04-2023] = Time and Date of activation, [2ev.] = Number of devices in alarm, (2) = Event number  
 Zone Label = Label for Zone 1

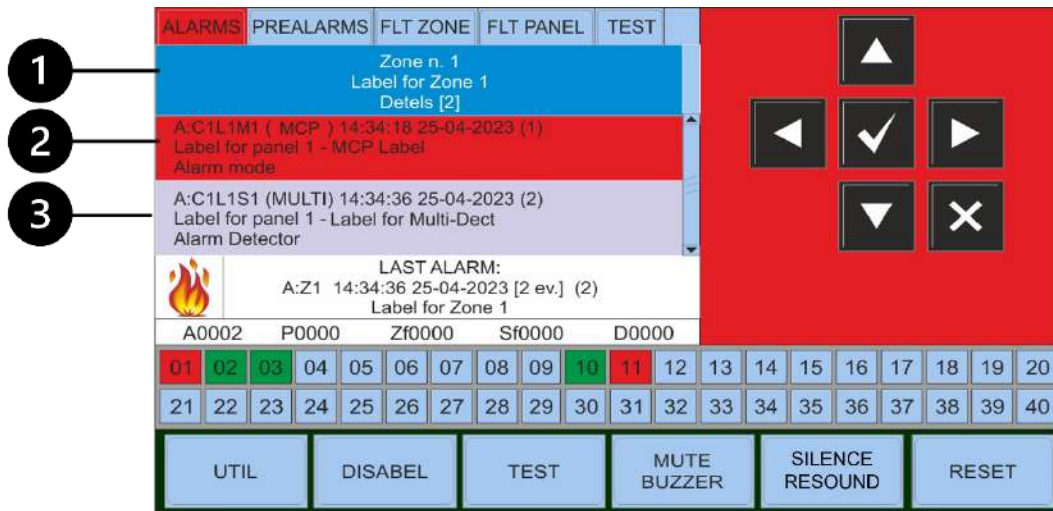
**Selecting the Zone** - using the select key , users can view the details of the device(s) in alarm.



- ① Selected Zone Number. 'Zone n. 1' = Zone 1  
Using the arrow keys   user can highlight the devices in alarm. Arrow keys will also scroll down for more than 2 devices in alarm condition.

---

- ② First Alarm details:  
**'A:C1L1M1 (MCP) 14:34:18 25-04-2023 (1)'**  
'Label for Panel 1 – MCP Label'  
'Alarm module'  
= Location on device/address – [A:C1L1M1] = Alarm C1=CPU/Panel number 1, L1= Loop Number 1, M1 = Module address 1. [(PULL)] device type ID = PULL or MCP (manual call point), [14:34:18 25-04-2023] = Time and Date of activation, (1) = Event number within the selected Zone.  
[Label for panel 1] = CPU/Panel label, [MCP Label] = Device Label  
[Alarm module] = Device type (module or detector)

---

- ③ Last Alarm details:  
**'A:C1L1S1 (MULTI) 14:34:36 25-04-2023 (2)'**  
'Label for Panel 1 – Label for Multi-Dect'  
'Alarm Detector'  
= Location on device/address – [A:C1L1S1] = Alarm C1=CPU/Panel number 1, L1= Loop Number 1, S1 = Detector address 1. [(MULTI)] device type ID = Multi (Multi criteria detector (opt/heat, opt/heat/IR)), [14:34:36 25-04-2023] = Time and Date of activation, (2) = Event number within the selected Zone.  
[Label for panel 1] = CPU/Panel label, [Label for Multi-Dect] = Device Label  
[Alarm Detector] = Device type (module or detector)

**LCD7 Repeater Fault**

In the event of a Panel or Zone Fault, the MA-LCD7 will display the Fault tab (FLT Zone or FLT Panel). For Zone Faults, the Faults will be listed by Zones. Using the arrow keys ▲▼ to highlight the Zone and then using the select key ✓, users can view the details of the device(s) or details of the Zone's Fault. If more than one device or Zone's Fault within the same Zone, then all devices and Faults will be displayed.

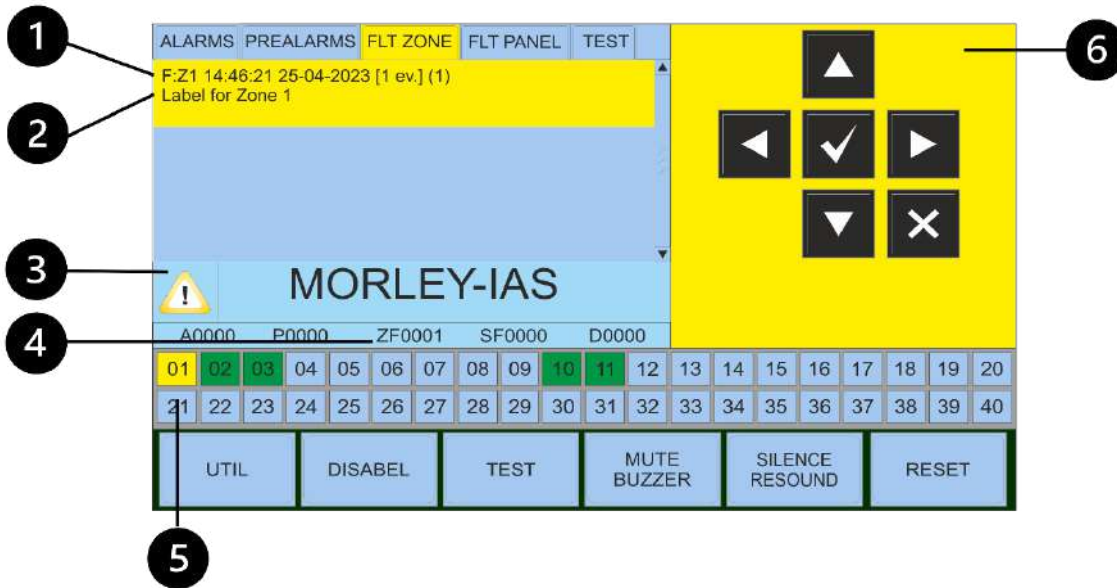

- ① Fault details – Example: ‘**F:Z1 14:46:21 25-04-2023 [1 ev.] (1)**’  
 Zone in Fault – [**F:Z1**] = Fault in Zone 1, [**14:46:21 25-04-2023**] = Time and Date of activation, [**1ev.**] = Number of devices in Fault, (**1**) = Event number  
 To view the device details of the Zone Fault, press the select key **✓**

---

- ② Zone Label – Displays the Zone Label (up to 32 characters)

---

- ③ Event Icon – WARNING icon Indicates Fault condition.

---

- ④ Event Summary – ZF0001 = Total number of Zones in Fault

---



- ⑤ Virtual Zonal Indicators – Virtual Zone 1 displaying Yellow – Indicates Zone 1 in Fault condition

---

- ⑥ Background Colour – Yellow = Fault condition (Zone or Panel Fault)

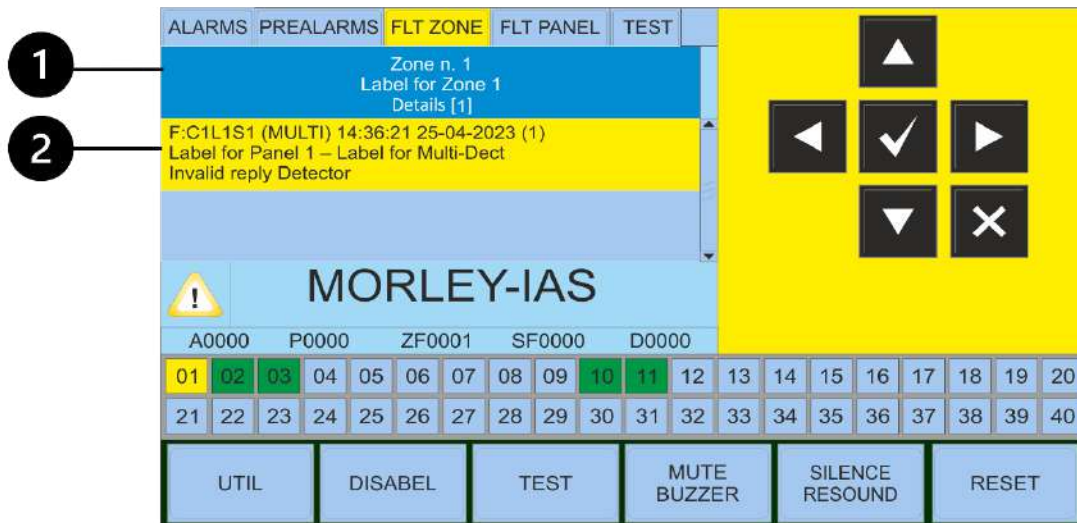
**Selecting the Zone** - using the select key , users can view the details of the device(s) in Fault.



- ① Selected Zone Number. 'Zone n. 1' = Zone 1  
Using the arrow keys   user can highlight the devices in Fault. Arrow keys will also scroll

---

- ② First Fault details: Example:  
**'F:C1L1S1 (MULTI) 14:36:21 25-04-2023 (1)'**  
 'Label for Panel 1 – Label for Multi-Dect'  
 'Invalid reply to Detector'  
 = Location on device/address – [F:C1L1S1] = Alarm **C1**=CPU/Panel number 1, **L1**= Loop Number 1, **S1**  
 = Detector address 1. [(MULTI)] device type ID = Multi (Multi criteria detector (opt/heat, opt/heat/IR)),  
 [14:36:21 25-04-2023] = Time and Date of activation, (1) = Event number within the selected Zone.  
 [Label for panel 1] = CPU/Panel label, [Label for Multi-Dect] = Device Label  
 [Invalid reply to Detector] = Fault reported on device

**MA-LCD7 Repeater Pre-Alarm**

In the event of a Pre-Alarm, the MA-LCD7 will display the Pre-Alarm tab, listing the Zones in Pre-Alarm condition. Using the arrow keys ▲▼ to highlight the Zone and then using the select key ✓, users can view the details of the device(s). If more than one device is in a Pre-Alarm condition within the same Zone, then all Pre-Alarm devices will be displayed.

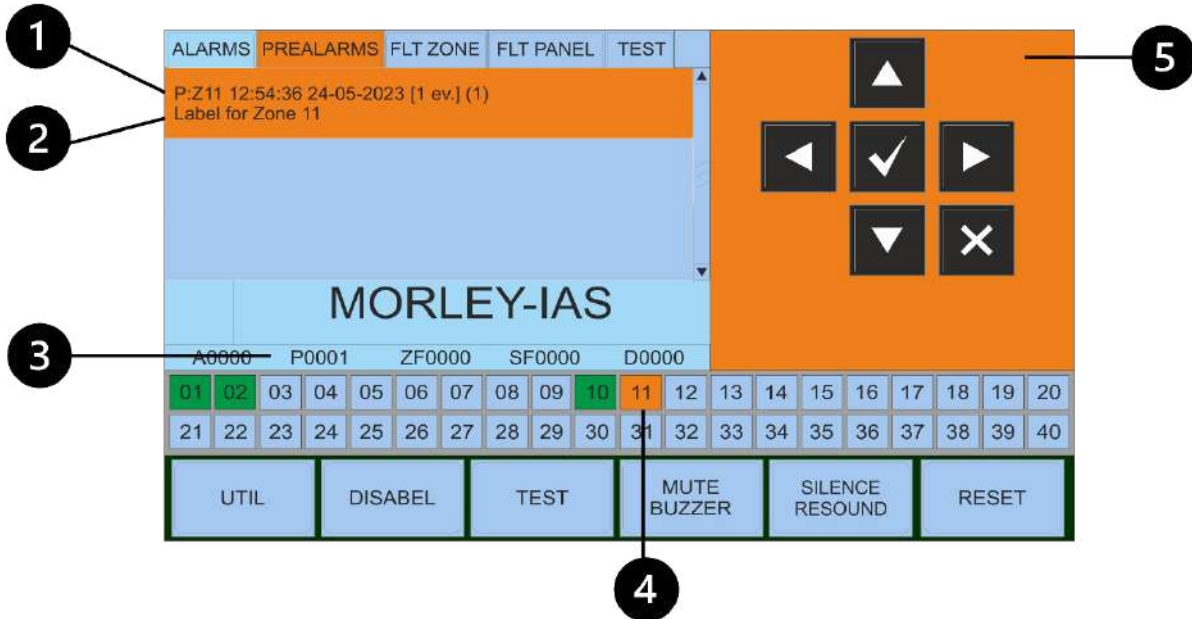

- ① Pre-Alarm details – Example: 'P:Z11 12:54:36 24-05-2023 [1 ev.] (1)'  
Zone in Pre-Alarm – [P:Z11] = Pre-Alarm in Zone 11, [12:54:36 24-05-2023] = Time and Date of activation, [1ev.] = Number of devices in Pre-Alarm, (2) = Event number  
To view the device details of the Pre-Alarm, press the select key ✓

---

- ② Zone Label – Displays the Zone Label (up to 32 characters)

---

- ③ Event Summary – P0001 = Total number of Zones in Pre-Alarm

---

- ④ Virtual Zonal Indicators – Virtual Zone 11 displaying Amber– Indicates Zone 11 in Pre-Alarm condition

---

- ⑤ Background Colour – Amber = Pre-Alarm condition

**Selecting the Zone** - using the select key , users can view the details of the device(s) in Pre-Alarm.

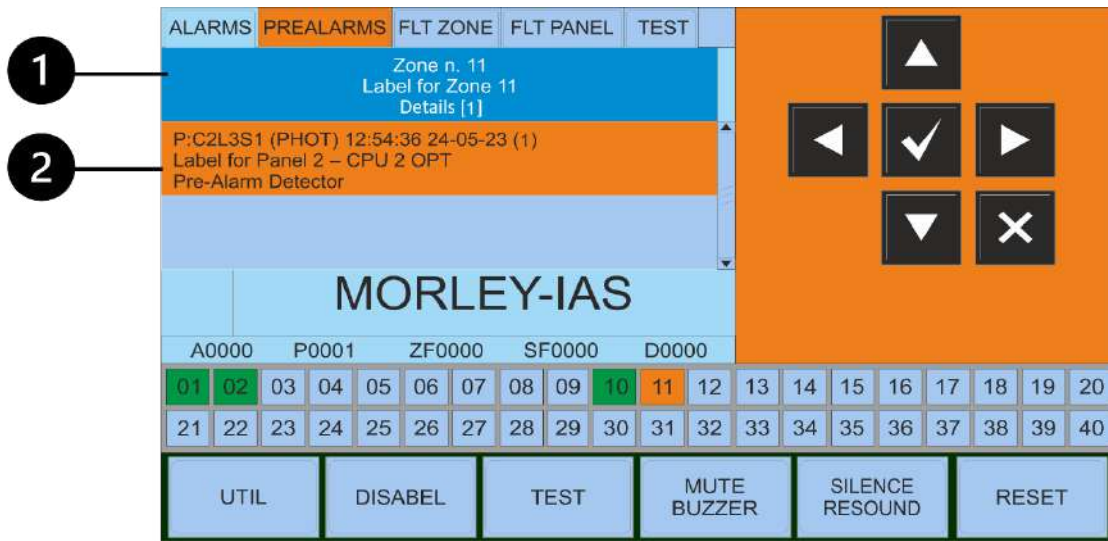

- ① Selected Zone Number. 'Zone n. 11' = Zone 11  
Using the arrow keys ▲▼ user can highlight the devices in Pre-Alarm. Arrow keys will also scroll

---

- ② First Fault details: Example:  
**'P:C2L3S1 (PHOT) 12:54:36 24-05-23 (1)'**  
 'Label for Panel 2 – CPU 2 OPT'  
 'Pre-Alarm Detector'  
 = Location on device/address – [**P:C2L3S1**] = Pre-Alarm **21**=CPU/Panel number 2, **L3**= Loop Number 3,  
**S1** = Detector address 1. [(**PHOT**)] device type ID = Photo/Optical Detector, [**12:54:36 24-05-23**] = Time and Date of activation, (**1**) = Event number within the selected Zone.  
 [Label for panel 2] = CPU/Panel label, [CPU 2 OPT] = Device Label  
 [Pre-Alarm Detector] = Pre-Alarm condition on device

**MA-LCD7 Repeater Test**

Zone Test Mode is initiated on the Max control panel. The MA-LCD7 will display in the Test tab, showing the Zone in test. Using the arrow keys ▲▼ to highlight the selected Zone and then using the select key ✓, users can view the details of the device(s) tested within the Zone Test.

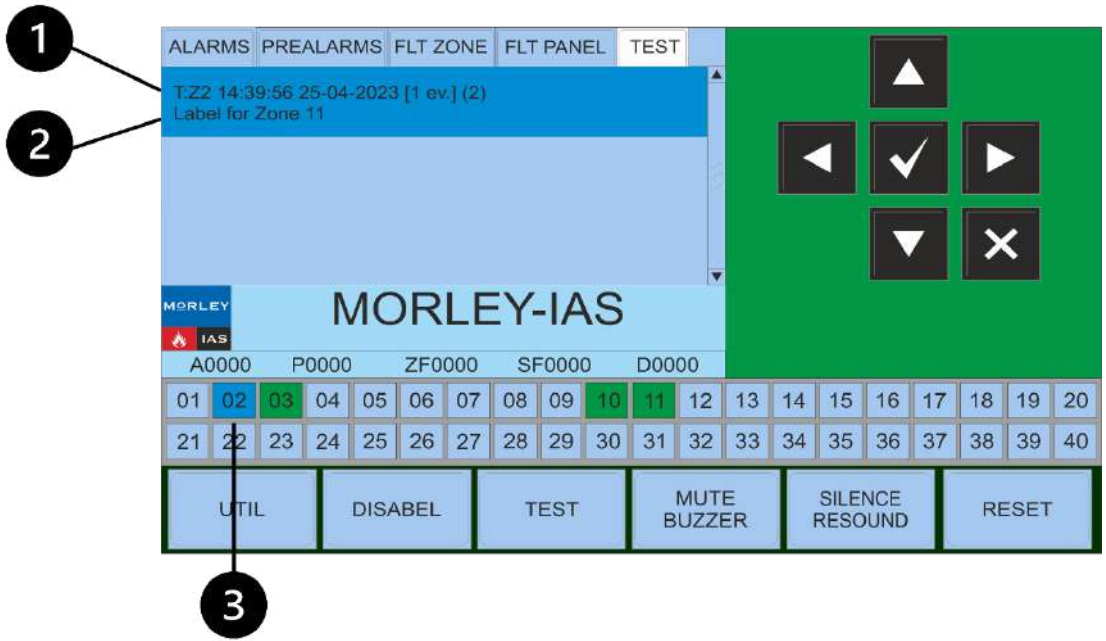

- ① Test details – Example: ‘T:Z2 14:39:56 25-04-2023 [1 ev.] (2)’  
 Zone in Test – [T:Z2] = Test Mode in Zone 2, [14:39:56 25-04-2023] = Time and Date of activation, [1ev.] = Number of devices tested within the Zone, (2) = Event number  
 To view the device details of the devices within the Zone, press the select key ✓

---

- ② Zone Label – Displays the Zone Label (up to 32 characters)

---

- ③ Virtual Zonal Indicators – Virtual Zone 2 displaying Dark Blue – Indicates Zone 2 is in Test Mode

**Selecting the Zone** - using the select key , users can view the details of the device(s) tested.

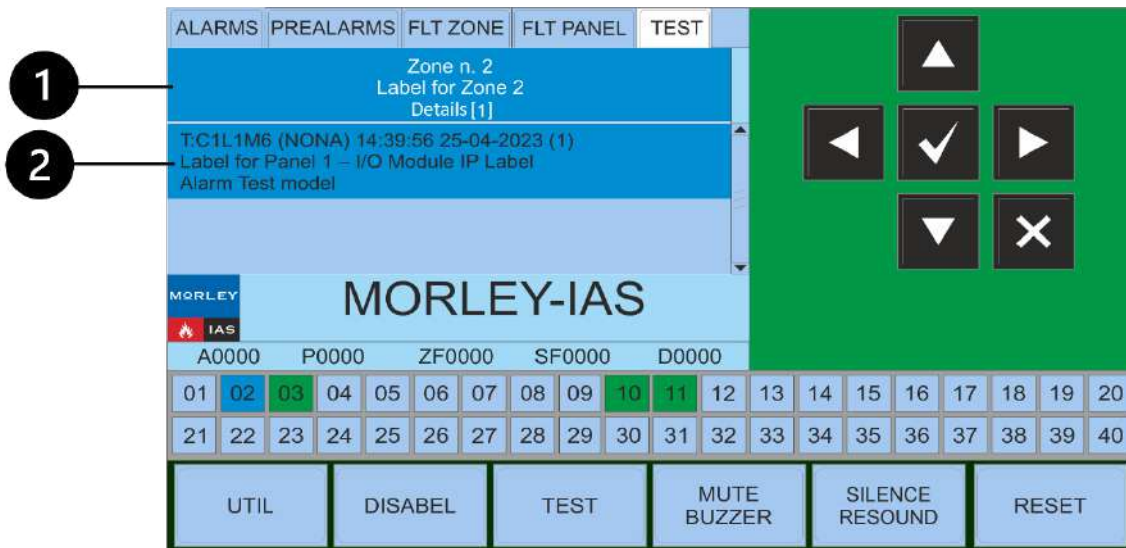

- ① Selected Zone Number. 'Zone n. 2' = Zone 2  
Using the arrow keys ▲▼ user can highlight the devices that have been Tested. Arrow keys will also scroll
- ② First Test details: Example:  
**'T:C1L1M6 (NONA) 14:39:56 25-04-2023 (1)'**  
 'Label for Panel 1 – I/O Module IP Label'  
 'Alarm Test Model'  
 = Location on device/address – [T:C1L1M6] = Alarm **C1**=CPU/Panel number 1, **L1**= Loop Number 1, **M6** = Module address 6. [(NONA)] device type ID = NONA (Non-Alarm Input), [14:39:56 25-04-2023] = Time and Date of activation, (1) = Event number within the selected Zone.  
 [Label for panel 1] = CPU/Panel label, [I/O Module IP Label] = Device Label  
 [Alarm Test module] = Condition Alarm test of module

### 8.2.4 MA-LCD7M Virtual Zonal Mimic

Mimic (MA-LCD7M) typical screen elements are identified below which aide in the identification of events. The Virtual Zonal Mimic is designed to display the status of the Zones across the Network or Local panel. 7 colour statuses for each Zone can be displayed depending on the event.



- ① **Virtual Zonal Indicators**  
Range 1-2000 – Displays up to 80 Zones per MA-LCD7M Mimic. Select each Zone to display more information.

---

- ② **Connected Status:**  
Displays the connection status to the Max Control Panels (ONLINE/OFFLINE)

---

- ③ **Legend:**  
Selecting this option displays all 7 colour Zonal Indicators with description

---

- ④ **Utility Menu:**  
UTIL = Utility Menu - Opens Utility Menu options

---

- ⑤ **Date and Time:**  
Display current Date and Time.

**MA-LCD7M Mimic Fire/Alarm**

In the event of a Fire Alarm, the MA-LCD7M will display the Zone in 'Alarm' as RED. Selecting the Zone, users can view the details of the device(s) in Alarm. If more than one device within the same Zone is in Alarm, then all devices will be displayed.

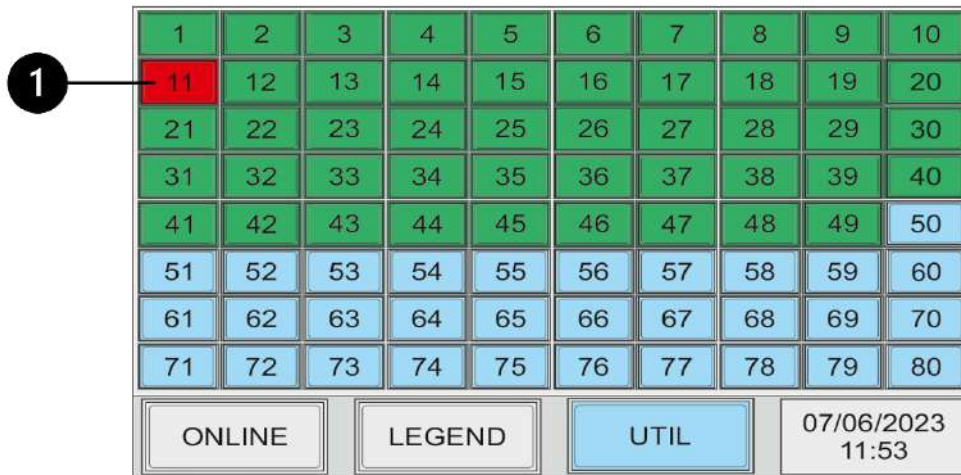

① Virtual Zone displays in RED indicating a fire alarm event in Zone 11



If the Zone in alarm does not appear in the Zonal Range, no alarm indication will be displayed on the Mimic.

Up to 80 Zones can be displayed on each MA-LCD7M Mimic. A maximum of 1120 Virtual Zones can be displayed.

Selecting any Zones will display more information regarding the status of the Zone.

In Fire Alarm condition, pressing the Zone in fire will display the Zone information, similar to the MA-LCD7 Repeater Alarm Tab.

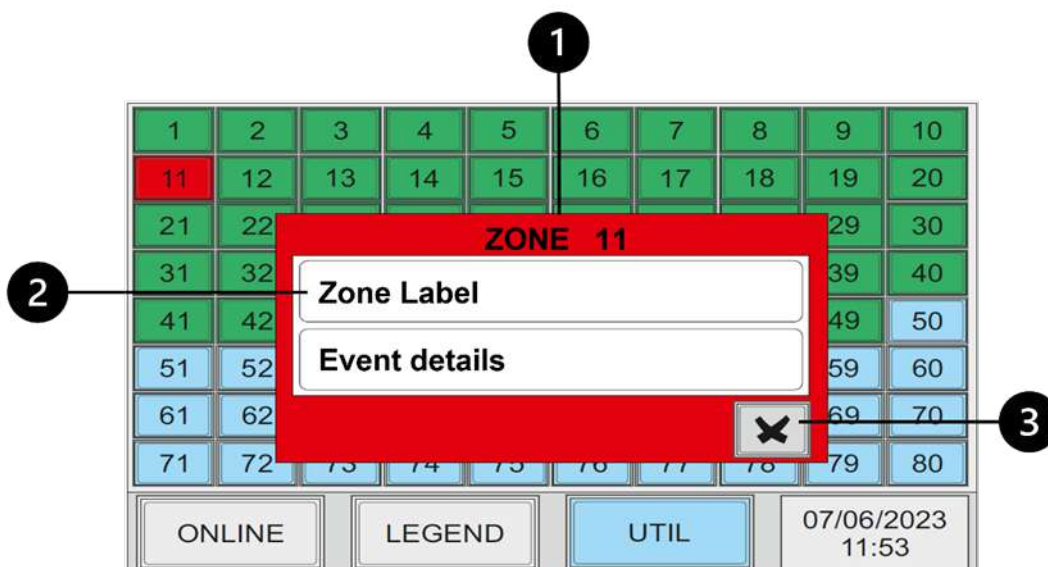

- ① **Zone Number:**  
Displayed at the top of the pop-up is the Zone number. Zone 11 – Pop-up will display Zone colour status.
- ② **Zone Label:**  
Displays the Zone Label (up to 32 characters)  
Event details: Displays the event or alarm details for the Zone. This will include details of the device.
- ③ **Cancel button:**  
To exit the current Zone pop-up. Press the X to return to the Mimic Zonal Screen.

Each event type will be displayed by selecting the coloured Zones.

**Zone Fault**

The screenshot displays a 10x10 grid of zones. Zone 5 is highlighted in yellow. A yellow pop-up window titled "ZONE 5" is overlaid on the grid, containing two text input fields: "Zone Label" and "Event details". A close button (X) is located in the bottom right corner of the pop-up. Below the grid is a status bar with three buttons: "ONLINE", "LEGEND", and "UTIL". To the right of the buttons, the date and time "07/06/2023 11:53" are displayed.

**Zone Pre-Alarm**

The screenshot displays a 10x10 grid of zones. Zone 11 is highlighted in orange. An orange pop-up window titled "ZONE 11" is overlaid on the grid, containing two text input fields: "Zone Label" and "Event details". A close button (X) is located in the bottom right corner of the pop-up. Below the grid is a status bar with three buttons: "ONLINE", "LEGEND", and "UTIL". To the right of the buttons, the date and time "07/06/2023 11:53" are displayed.

**Zone Disabled**

The screenshot displays a 10x10 grid of zones. Zone 6 is highlighted in grey. A grey pop-up window titled "ZONE 6" is overlaid on the grid, containing two text input fields: "Zone Label" and "Event details". A close button (X) is located in the bottom right corner of the pop-up. Below the grid is a status bar with three buttons: "ONLINE", "LEGEND", and "UTIL". To the right of the buttons, the date and time "07/06/2023 11:53" are displayed.

Zone Test

1	2	3	4	5	6	7	8	9	10
11	12	13	14	15	16	17	18	19	20
21	22	23	24	25	26	27	28	29	30
31	32	<b>ZONE 5</b>						39	40
41	42	Zone Label						49	50
51	52							59	60
61	62	63	64	65	66	67	68	69	70
71	72	73	74	75	76	77	78	79	80
ONLINE			LEGEND			UTIL		07/06/2023 11:53	

Zone Healthy

1	2	3	4	5	6	7	8	9	10
11	12	13	14	15	16	17	18	19	20
21	22	23	24	25	26	27	28	29	30
31	32	<b>ZONE 5</b>						39	40
41	42	Zone Label						49	50
51	52							59	60
61	62	63	64	65	66	67	68	69	70
71	72	73	74	75	76	77	78	79	80
ONLINE			LEGEND			UTIL		07/06/2023 11:53	





**Honeywell**  
**MORLEY IAS Fire Systems**  
(Pittway Tecnologica, S.r.l.)  
Via Caboto, 19/3  
34147 Trieste, Italy

M-167.6-MA-LCD-EN / 10.2023  
Technical changes reserved!  
© 2023 Honeywell International Inc.

