

NEW RANGE OF PDUs & iPDU's

LCS 3

3 DIMENSIONS OF EXCELLENCE

◆ PERFORMANCE ◆ SCALABILITY ◆ EFFICIENCY

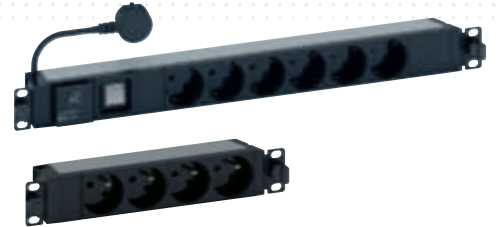

CATALOGUE
PAGES
INSIDE

INNOVATIVE POWER INFRASTRUCTURE
SOLUTIONS FOR DATA CENTERS
AND NETWORKS



LCS

3

3 DIMENSIONS OF EXCELLENCE

● PERFORMANCE ● SCALABILITY ● EFFICIENCY



EXCLUSIVE TO LEGRAND

OUR PDUs FEATURE EXCLUSIVE LEGRAND INNOVATIONS. THEY ARE IDENTIFIED BY THE FOLLOWING SYMBOLS



iPDUs, INTELLIGENCE AT THE HEART OF YOUR NETWORKS

From a complete data center to a small-scale Edge deployment, Legrand's range of power products now integrates new intelligent PDUs (iPDUs) which can be used to monitor and control the rack power infrastructure remotely, in order to efficiently manage power capacity and ensure uptime.

CONTENTS

02	SOLUTIONS FOR ANY CONFIGURATION
04	INTELLIGENT POWER SUPPLY MANAGEMENT
06	CORD LOCKING SYSTEM, INNOVATION AT THE HEART OF PDUs
08	ZERO-U PDUs, INNOVATION & PERFORMANCE
10	1-U PDUs, INNOVATION & CONVENIENCE
12	NEW CONTROLLER, THE HEART OF iPDUs
14	METERED & SWITCHED iPDUs, ADVANCED MONITORING
16	SWITCHED iPDUs, METERING AND CONTROL
18	METERED iPDUs, ENERGY MEASUREMENT
19	METERED & SWITCHED iPDUs WITH RARITAN SMARTSENSORS™
20	PROTECTION ACCESSORIES
22	SERVICES: STANDARD AND CONFIGURE-TO-ORDER PDUs
24	SELECTION CHART
26	CATALOGUE PAGES

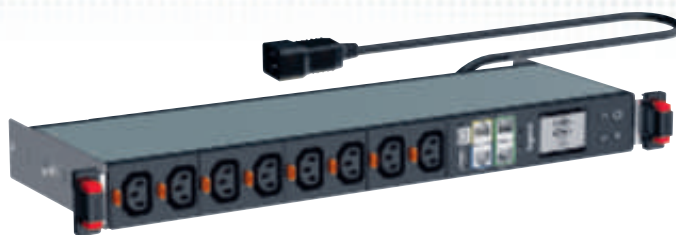

PDU_s, SOLUTIONS FOR ANY CONFIGURATION

A WIDE UNIVERSAL RANGE

The new PDU offer combines Legrand's quality and innovation with a wide range of applications. A standalone solution, this range integrates seamlessly into any installation, ensuring compliance with applicable standards.

GENERAL CHARACTERISTICS

- Anodised aluminium Chassis: High-quality material, lightweight and rigid
- Modular design: Expandable socket and function modules

SAFETY

- High-quality electrics
- High-quality connection
- Sockets equipped with safety shutter

• **Cord Locking system** (see page 6)



POWER SUPPLY

- 16 A to 32 A, single- or three-phase
- PDUs incorporating both international and local type sockets



STANDARDS

- **IEC 60950** - Information technology equipment - Safety
- **IEC 60297-3** - Dimensions of mechanical structures of the 482.6 mm series (19 in)
- **IEC 60320-2-2** - Appliance couplers for C13 and C19 electrical equipment
- **IEC 60884-1** - French/Belgian and German standard plugs/sockets
- **BS 1363-2** - British standard plugs/sockets
- **IEC 60309** - Industrial plugs

Certification: CE, TSE, CCC

Environmentally-friendly products
Eco-design



FOR DATA CENTERS/SERVER ROOMS

- These are used in server cabinets where:
- there is a high density of active equipment
 - electrical distribution quality is crucial

14 BASIC PDU CATALOGUE NUMBERS
9 INTELLIGENT PDU CATALOGUE NUMBERS

FOR VERTICAL INSTALLATION

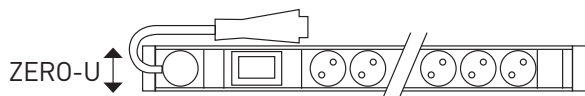

1-U PDU 19"



FOR DATA CENTERS, EDGE SERVER ROOMS AND COMPUTER ROOMS

These are used in patching and server enclosures where:

- there is a low density of active equipment to be powered
- ease of installation is an advantage

29 BASIC PDU CATALOGUE NUMBERS

4 INTELLIGENT PDU CATALOGUE NUMBERS

FOR VERTICAL OR HORIZONTAL INSTALLATION

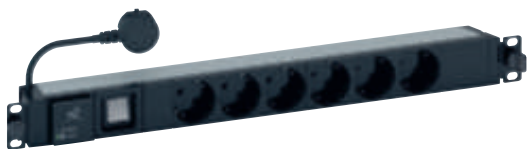
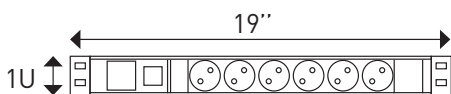

1-U PDU 10"



FOR SMALL IT ENVIRONMENTS

These are mainly used in small-scale commercial applications where there are a limited number of computer workstations and a 10" cabinet is sufficient:

- Small businesses, freelance professions, administrative services, etc.

3 CATALOGUE NUMBERS

HORIZONTAL PDU

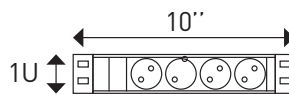

INTELLIGENT, EFFICIENT POWER SUPPLY MANAGEMENT

INCORPORATING INTELLIGENT, INNOVATIVE FUNCTIONS

PDUs can help meet the needs for energy while incorporating intelligent functions, including real-time power metering and environmental monitoring. Connected PDUs (iPDUs) include measurement of consumption and switching of active power and remote alarm with volts, amperes, real-time power (kW) and energy (kWh) measurements.



Legrand Metered and Switched models provide the most common power supply configurations to meet the needs of data centers and local networks.

BASIC PDUs

 P.8 to 11



ENERGY DISTRIBUTION

For implementation in LANs or data centers, these are easily mounted and have numerous configuration options



AVAILABLE IN VERTICAL ZERO-U
AND HORIZONTAL 1U 19" VERSIONS

METERED & SWITCHED iPDUs P.14 to 19



POWER SWITCHING AND REAL-TIME MONITORING

With input metering and output level switching, these can be used to remotely control the power of devices and supply the necessary information as needed. Multiple configurations are available

METERED iPDUs P.18



ACCURATE MEASUREMENT

With input metering, Legrand PDUs can provide accurate energy consumption measurements. Multiple configurations possible

PDU FUNCTIONS BY RANGE	BASIC	METERED	SWITCHED
Ammeter	•		
Phase measurement (kWh, V, A, PF)		•	•
Circuit measurement (kWh, V, A, PF)		•	•
Circuit breaker trip detection		•	•
Socket management (Switching & Control)			•

CORD LOCKING SYSTEM

INNOVATION AT THE HEART OF PDUs

FOR C13 & C19
SOCKET
OUTLETS



Security of cable connection at rack level is a critical element which must be considered to ensure longevity of the installation. All Legrand PDUs have a power supply cord locking system which prevents accidental disconnection due to human error or vibration and guarantees absolute safety. Function integrated in all Legrand PDUs: Basic, Metered, Metered and Switched.

AN INNOVATIVE TECHNICAL SOLUTION



CORD LOCKING SYSTEM

Very easy to identify thanks to the orange buttons next to each socket outlet





1 CONNECTION

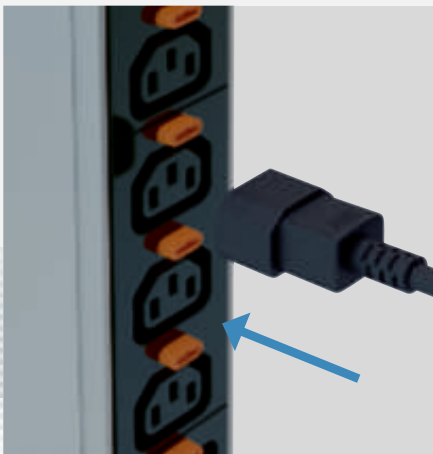

CORD CONNECTION
The cord is connected to the socket naturally in one smooth action

2 AUTO LOCKING

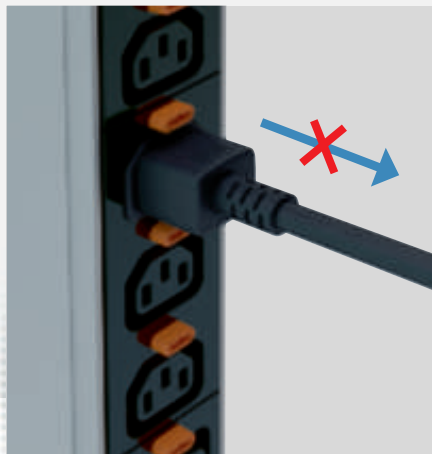

CORD HELD IN PLACE
Once the power supply cord is connected, it locks automatically and cannot be removed

3 UNLOCKING

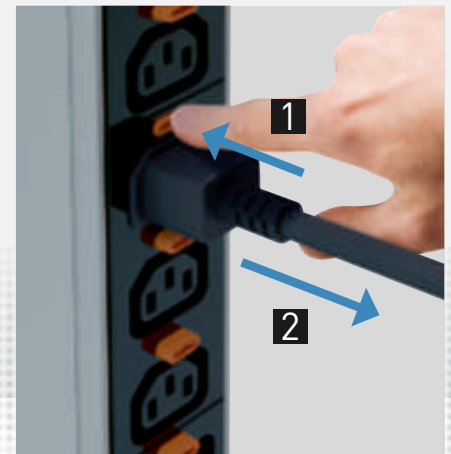

EASY REMOVAL
Simply pressing the unlock button releases the cord from the socket

UNIVERSAL SYSTEM

Takes all cords for standard C13 and C19 sockets

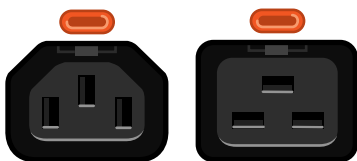

EXCLUSIVE TO LEGRAND

ZERO-U PDUs

INNOVATION & PERFORMANCE

EXCLUSIVE INNOVATIONS

Every detail matters! Legrand's unique and original innovations help ensure optimum performance for the ZERO-U range of PDUs, in terms of safety, simplified setup and integration, consumption indicators, etc.

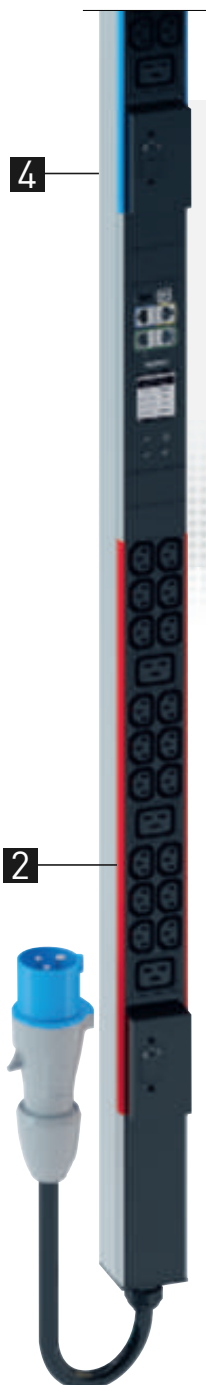

STANDARD STRUCTURE FOR BASIC, METERED & SWITCHED PDUs

1 ROTATIVE CABLE ENTRY

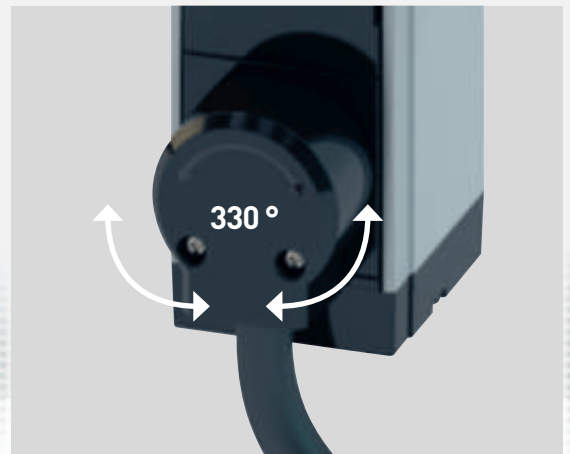

CABLE ORIENTATION

330° rotatable cable entry for perfect cable orientation and no interference in the cabinet

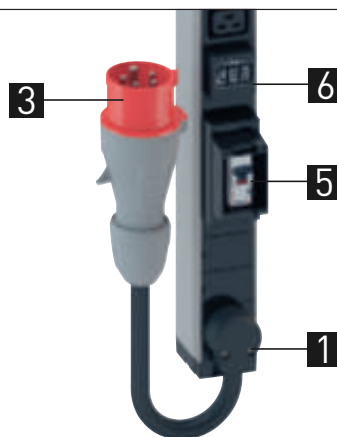

VERTICAL
INSTALLATION



2 CIRCUIT MARKING

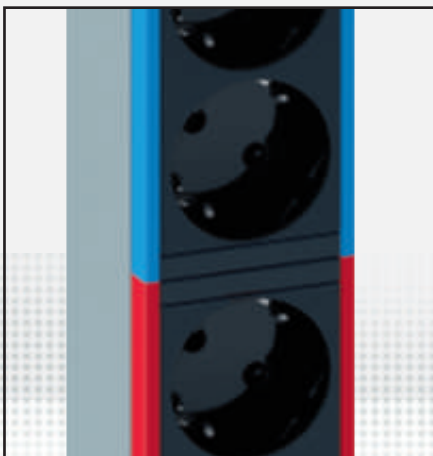

CIRCUIT IDENTIFICATION

Each circuit is colour-coded, with the colour visible on the front panel and along the edges of a module. The colour corresponds to the specific MCB protecting the circuit.

3 INPUT POWER

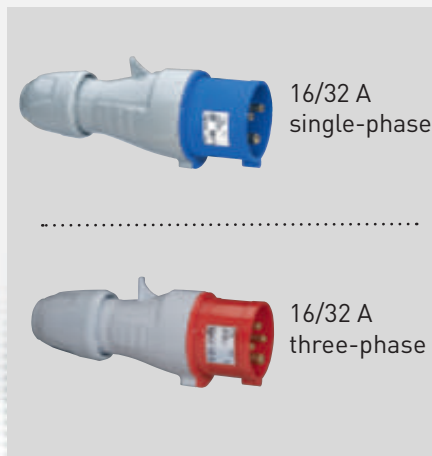

ENHANCED PROTECTION

There are multiple solutions depending on power supply requirements

4 SCREWLESS MOUNTING

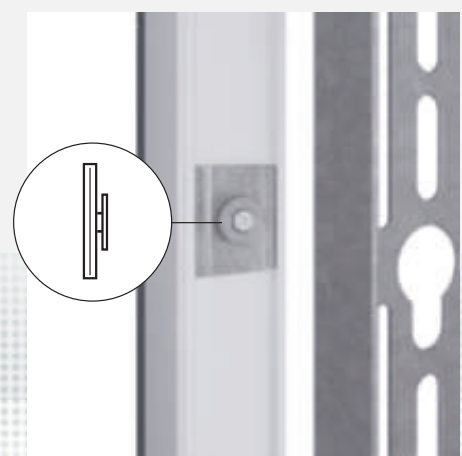

FIXED IN BUTTONHOLE SLOTS

ZERO-U PDUs simply clip vertically into buttonhole slots on the mounting bracket without the need for any screws.

OPTIONS FOR BASIC PDUs ONLY

5 CIRCUIT BREAKER HOLDER



ENHANCED PROTECTION

Circuits protected by a circuit breaker. Holder with overhanging edges to prevent accidental breakages. (Cover available on request)

6 AMMETER



CONSUMPTION INDICATOR

- Circuit balancing
- Display of available capacity
- Overload prevention

EXCLUSIVE TO LEGRAND

1-U PDUs

INNOVATION & CONVENIENCE

SIMPLE SETUP AND INTEGRATION

The 19" PDUs designed for installation in server cabinets and patch panels also incorporate the latest innovations for facilitating integration and maintenance, with clever mounting and operating features.

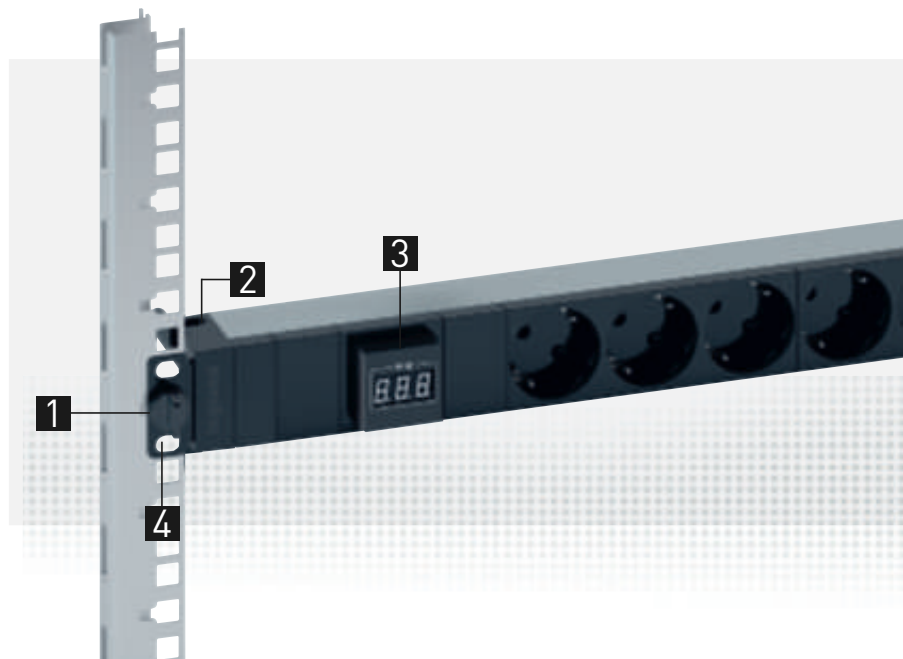

PDU 1 U 10"

Specially designed for local area networks, these PDUs feature the same innovations as the 19" range.

HORIZONTAL INSTALLATION 



HORIZONTAL OR VERTICAL INSTALLATION



1 SNAP-ON FIXING



TOOLLESS INSTALLATION

Snap-on fixing on 19" uprights
No need for screws or nuts.
Toolless installation.

2 CABLE GUIDE



OPTIMISING SPACE

Cables are held firmly in place by a cable guide.

3 AMMETER

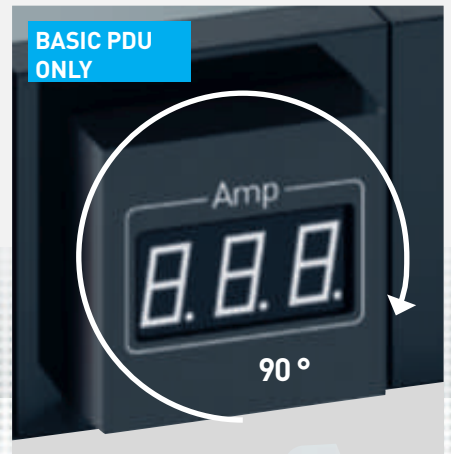

ROTATABLE DISPLAY

The ammeter can be rotated 90° to ensure easy reading regardless of mounting position (horizontal or vertical).

4 MOUNTING BRACKETS

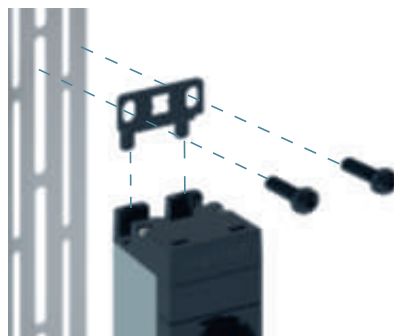
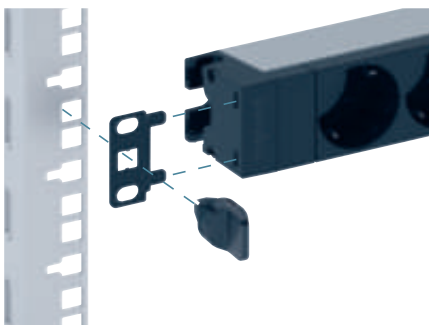

HORIZONTAL OR VERTICAL

Designed for horizontal toolless mounting, 1-U PDUs can also be mounted vertically simply by rotating the mounting lugs. Vertical mounting requires a bolt and nut to fix the PDU securely to the bracket.

EXCLUSIVE TO LEGRAND

NEW CONTROLLER: THE HEART OF IPDUs

A WIDE BRIGHT COLOR LCD DISPLAY

The new Legrand PDU controller allows local access to all critical measurement data. The bright color LCD display will change colour according to the alert level detected by the iPDUs; your field technicians can quickly identify iPDUs on which the thresholds have been exceeded, obtain correct power supply data immediately and take appropriate action.

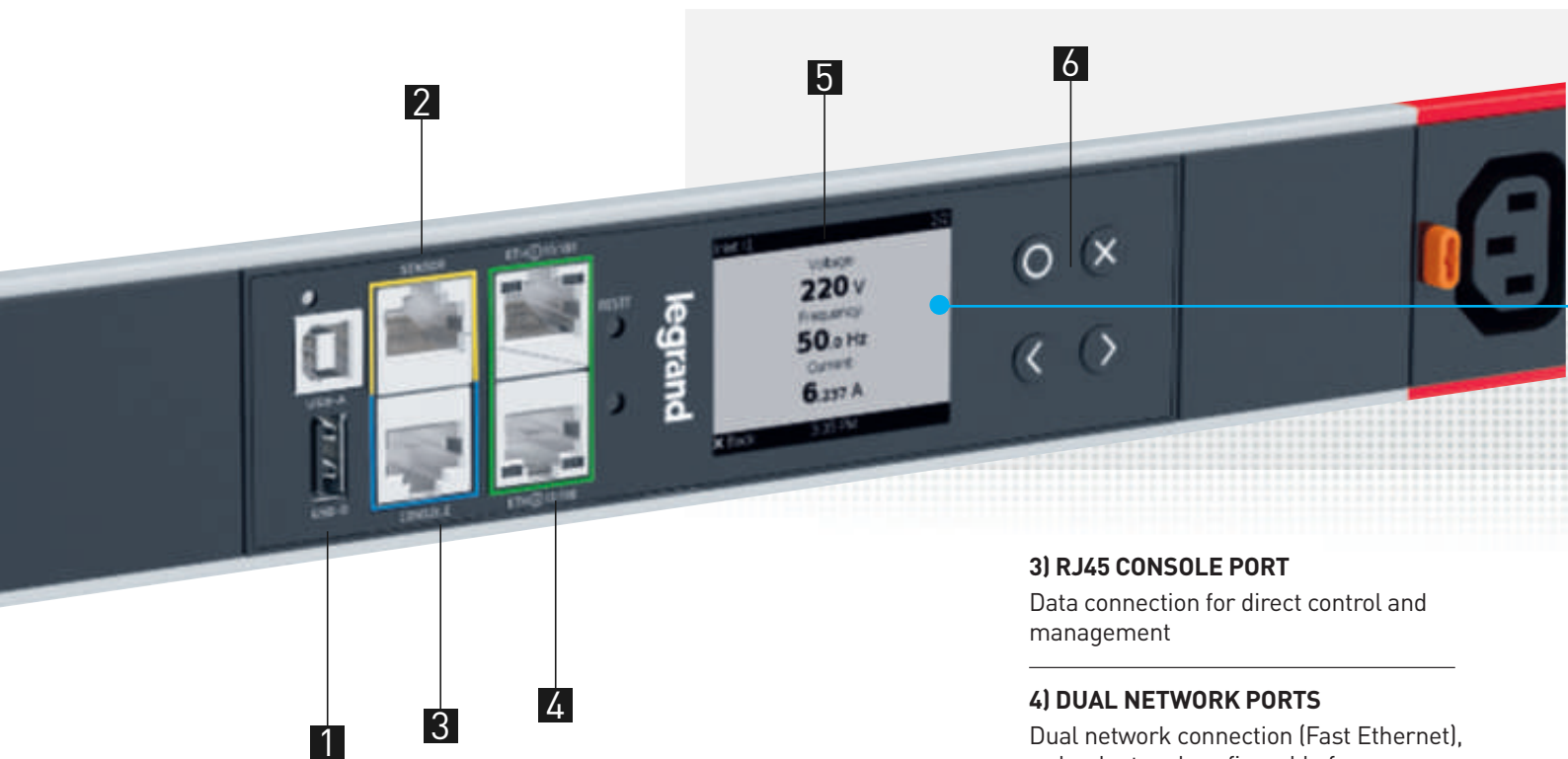

3) RJ45 CONSOLE PORT

Data connection for direct control and management

4) DUAL NETWORK PORTS

Dual network connection (Fast Ethernet), redundant and configurable for access to the PDU from 2 different networks, ideal for Colocation projects or for daisy-chaining PDUs

1) USB-A AND B PORTS



USB A and B ports for connecting peripheral devices, so data can be viewed on smartphones

2) RJ45 SENSOR PORT



Plug & Play sensor port for directly connecting temperature and humidity sensors and the Raritan SmartSensor™ range

5) LCD COLOR SCREEN

220 X 176 mm super bright screen with configurable measurement data display

6) INTUITIVE NAVIGATION BUTTONS

Navigation buttons for local screen

LOCAL DISPLAY



ADAPTIVE COLOUR SCREEN

The LCD display on the unit changes colour according to the alert level, making it easier for the technical teams to see the information

NEW PDU HTML USER INTERFACE



DIRECTLY ACCESSIBLE DATA

Makes it easier to view the data center power supply data and information about the environment. The responsive Web graphic interface can be accessed from any device or tablet, or directly from a desktop computer. The redesigned overview screen provides the most important

information at a glance, so you can easily monitor your PDU health and critical data, and also view the cabinet energy consumption in real time.

DCIM MONITORING

Legrand Metered and Switched PDU's can be used to export measurement and control data to any DCIM platform such as Sunbird Power IQ .



METERED & SWITCHED iPDUs

ADVANCED MONITORING

GOLD STANDARD ACCURACY

The first step in preventing outages in your data center consists of making sure that you have the most reliable and accurate monitoring data. Legrand iPDUs are certified to have +/- 1% measurement accuracy with all types of load in real time, you can be sure that your PDU is supplying the necessary information as and when needed.

ACCURATELY MEASURED ENERGY CONSUMPTION



REAL-TIME MEASUREMENT

Legrand PDUs are certified to have +/- 1% measurement accuracy with all types of load in real time, so you can be sure that your PDU is supplying the necessary information as and when needed.

With Legrand's Metered and Switched PDUs, a billing-grade energy metering chip is dedicated to the Inlet power supply module and provides extremely accurate KWH data for each tap-off circuit.

+/-1% HIGH-PERFORMANCE INPUT MEASUREMENT

Legrand PDUs benefit from the metering technology of Raritan, delivering a high-end measurement performance, which gives a clear picture of energy consumption.



CIRCUIT BREAKER INTELLIGENCE AND BRANCH CIRCUIT MONITORING



If a server power supply fails, your energy management system in the electrical panel will not detect this condition, only detection of the circuit breaker trip status will keep you informed in real time!

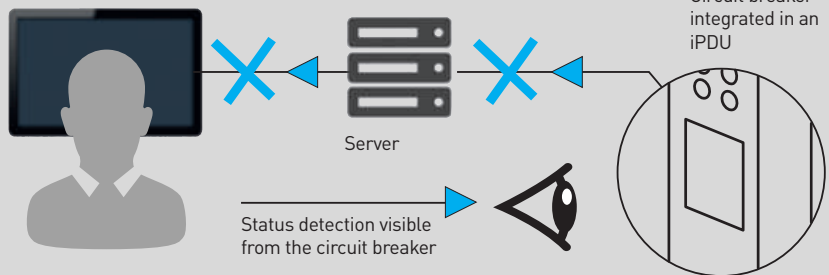

MONITORING CURRENT AND VOLTAGE AT THE CIRCUIT BREAKER LEVEL

Legrand iPDUs are equipped with standard Circuit breaker status monitoring and branch circuit metering (on 32A models), providing critical load-balancing and circuit load information per phase. This allows you to be alerted in time and avoid circuit overloads.

They can also be used to activate configurable alerts when a measurement is exceeded or when a circuit breaker drops. You are directly informed of the loss of power and can react quickly, preventing overloads on other circuits.

CIRCUIT OVERLOAD ALARM

Alarms defined by the user warn the IT managers and data centers of potential circuit overloads so as to prevent accidental loss of power to critical equipment.

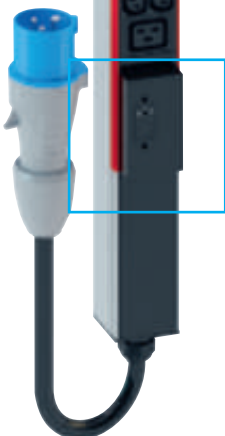

SWITCHED iPDUs

METERING & CONTROL

EASIER POWER MANAGEMENT

Legrand iPDUs also integrate input metering and output level switching, providing granular power switching of each device connected to the iPDU, and making it easier to manage IT installations remotely, while helping to improve availability.



1 CONFIGURABLE OUTLET REBOOTING SCHEDULE

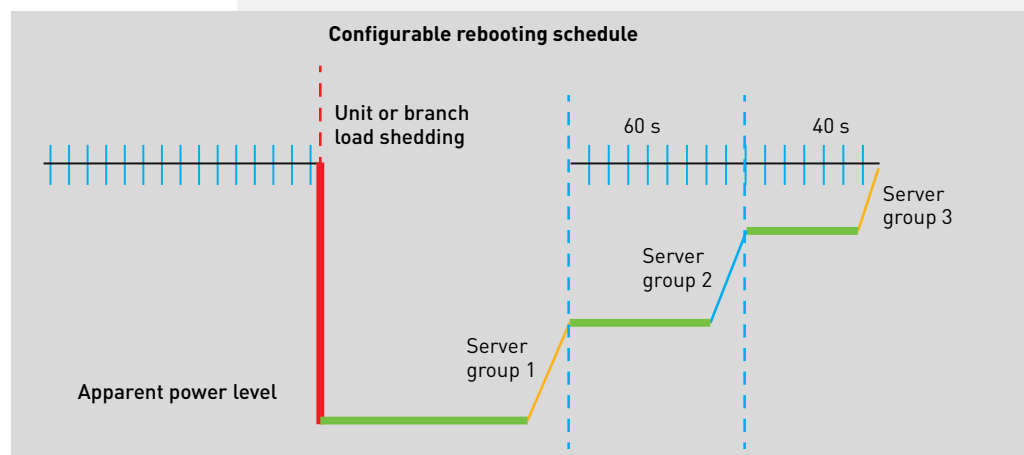

OUTPUT CONTROL

Automated restarting, load shedding and individual output control of socket outlets. Used to schedule restarting on each socket outlet in order to minimise the impact of the peak current on the servers.



AVAILABLE IN VERTICAL ZERO-U
AND HORIZONTAL 1U 19" VERSIONS

2 CIRCUIT BREAKER INTELLIGENCE



MAGNETIC-HYDRAULIC CIRCUIT BREAKER

Above 16 Amps, Legrand iPDUs have rugged circuit breakers with delayed tripping curve, guaranteeing maximum flexibility and safety of people and equipment.

The circuit breakers are monitored by the embedded firmware and issue configurable alerts in the event of an overload or unwanted tripping.

3 REMOTE SOCKET OUTLET MANAGEMENT

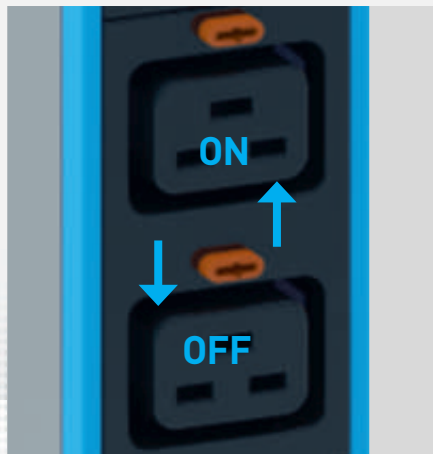

CONFIGURABLE CIRCUIT MANAGEMENT

Option of remotely switching sockets between one another and activating or deactivating individual sockets in real time on the network and managing the power sequencing of your device.

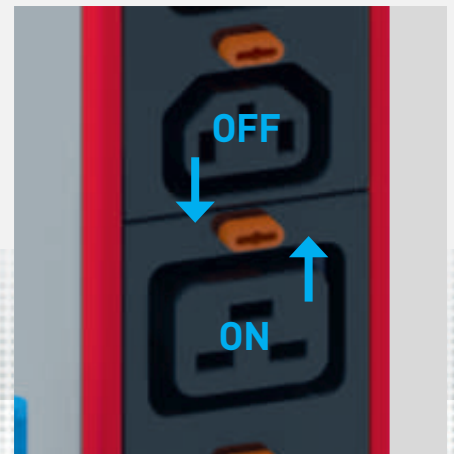

The use of switched models allows users to deactivate unavailable sockets remotely and avoid overloading the circuits by plugging in additional devices.

4 PROTECTION AGAINST UNCONTROLLED CONNECTIONS



REMOTE SOCKET MANAGEMENT

Remote socket management prevents human errors and can check that devices are only plugged in on available circuits, thus preventing overloads.

METERED iPDUs

ENERGY METERING

SEE ALL
CONSUMPTION
AT A GLANCE

Legrand iPDUs incorporate input metering, allowing accurate measurement of the unit's energy consumption, making it easy to understand power and manage data center growth.



CONNECTED LOADS



EASIER DATA COLLECTION IN THE CABINET

No more need to call in the technical teams to take on-site measurements in order to find out the energy consumption of your equipment, your intelligent iPDU takes care of it for you....

UNIT POWER

The overview of the rack power capacity and energy use makes it easy to understand clearly the remaining capacity in the cabinet so as to assist decisions about future growth.

METERED & SWITCHED WITH RARITAN PERIPHERALS

EASIER ACCESS CONTROL AND ENVIRONMENTAL MONITORING

By incorporating the Raritan technology platform, Legrand iPDUs benefit from the whole range of **SmartLock™** electronic door handles, and **SmartSensor™** environmental monitoring products. These plug and play peripherals make it easy to oversee the whole installation directly from your iPDU!

SmartSensor™ includes: temperature, humidity and contact closure sensors.

SmartLock™ includes: simple electronic handles, plus 125 kHz and 13.56 MHz card reader handles.

1 RARITAN SMARTSENSORS™

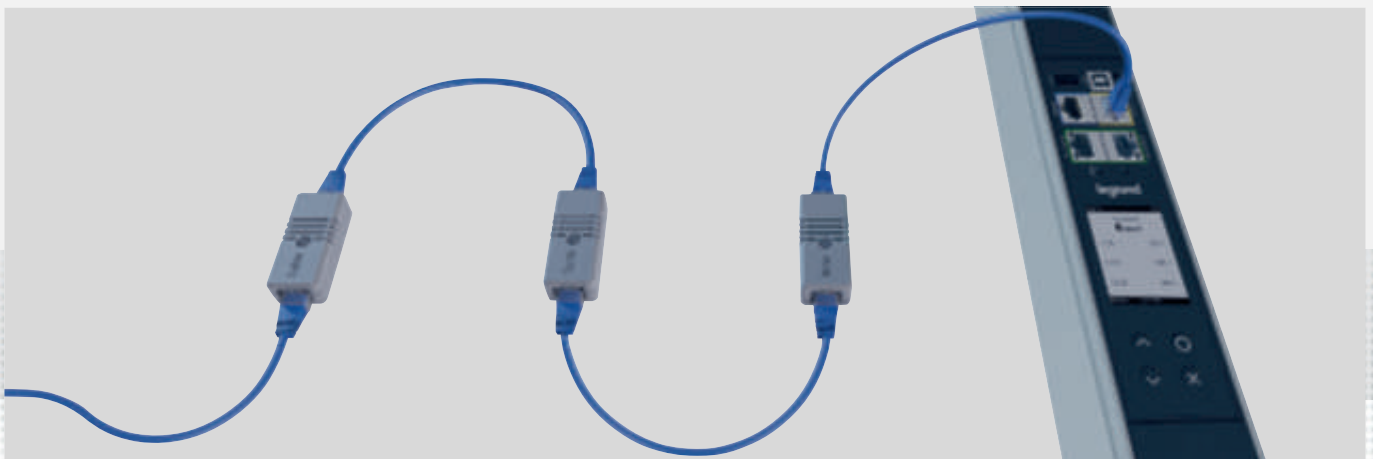

EASIER CONNECTION AND INTEGRATION

RJ45 technology simplifies the connectivity and implementation of sensors. All Raritan SmartSensors are easily integrated in the cabinet and can

be connected in a daisy-chain and replaced without having to rewire the cabinet.

www.raritan.com/smartsensors

2 RARITAN SMARTLOCK™

SIMPLIFIED ACCESS, CONTROL AND COMPLIANCE

Plug and Play with Raritan SmartLock™ electronic handles, Legrand iPDUs allow you to control and secure access to the cabinet with ease

www.raritan.com/smartlock



ACCESSORIES

FOR PROTECTION

ENHANCED SAFETY AND CONTROL

Compatible with all the PDUs in the Legrand range, the complementary accessories allow you to control the socket power supply and protect against overvoltages.



1 SOCKET LOCKING CAP ✓



CONTROLLING ACCESS TO THE POWER SUPPLY
 The locking cap can be used to lock access to a socket. A special key is required to unlock it.

Locking caps are available for the following socket standards: C13, C19, German, French-Belgian, British.



2 SURGE PROTECTIVE DEVICE



MODULAR SURGE PROTECTION
 The surge protection module protects equipment against overvoltages and incorporates hot swap technology. It can be used to replace a used module without interrupting the power supply to the other equipment connected to the PDU.

This is an essential accessory for business servers which need continuous protection. The module is equipped with a warning LED which indicates when it needs replacing.

✓ EXCLUSIVE TO LEGRAND

SERVICES

TAILORED TO YOUR PROJECTS

OFFERING MODULARITY AND RESPONSIVENESS

Legrand has leveraged its expertise to develop its new range of PDUs designed to function at the heart of your installations. Available in 2 formats - standard and configure-to-order products - the versatility of our range offers you greater flexibility and responsiveness.



CATALOGUE NUMBERS

Find all the catalogue numbers in the e-catalogue available at legrand.com

STANDARD CONFIGURATIONS

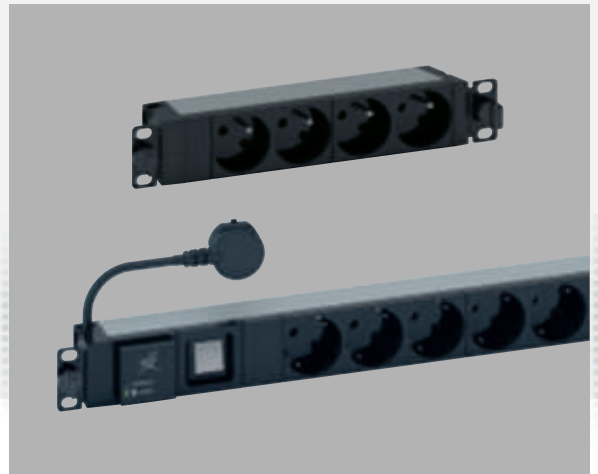

READY-TO-USE

Standard PDU ranges for fixed configurations which meet the most common requirements.

IPDUs AND BASIC
PDUs IN STANDARD
CONFIGURATION

60+
CATALOGUE
ITEMS



AVAILABLE
IN STOCK

**PDU's
CONFIGURE
TO ORDER
AS REQUIRED**

**SPECIALLY DESIGNED
FOR SPECIFIC APPLICATIONS**

Our PDUs are designed to ensure flexibility of use and to meet the needs of specialists. Whether you need more sockets or a higher power rating, specific protection or whether you wish to apply colour-coded identification to accentuate the redundant power supply, PDUs can do whatever you need.

CHOICE OF CONFIGURATIONS

CHOICE OF PLUG



16/32 A single-phase



16/32 A three-phase



SOCKET STANDARDS



CL13



CL19



German



French-Belgian



British



Nema S20



Swiss T13



Swiss T23



Italian



Chinese SP

PROTECTION



Hydro-Magnetic circuit breaker



Circuit breaker holder



Circuit breaker holder with cover



Thermal circuit breaker



Fuse



Surge and overvoltage protective device

ACCESSORIES



Ammeter



Load indicator



Illuminated switch

CABLE ENTRIES



Cable entry only



With cable only



With cable and plug



Cable gland



Rotating cable

EXAMPLES OF CONFIGURATION



**GREATER
RESPONSIVENESS
FOR ALL YOUR
CONFIGURE-TO-
ORDER PROJECTS**



**QUOTE
WITHIN
24 HRS**









**7 DAY
TURNAROUND
FOR BASIC PDUs**



**FROM RECEIPT OF
ORDER***

* WHEN ORDERING UP TO 100 PRODUCTS

A COMPREHENSIVE RANGE FOR NETWORK PROFESSIONALS

AMMETER PDUs					
Socket standard	Number of sockets	Casing	Max. power	Cable length	Cat. Nos.
  IEC60320	6	1U 19" aluminium	3.7 kW	cordless	646843
	7 [6 C13 + 1 C19]	Zero-U aluminium	7.4 kW		646844
	24 [20 C13 + 4 C19]		11 kW		646845
	24 [18 C13 + 6 C19]		3 m	646865	
 French/ Belgian	6	1U 19" aluminium	3.7 kW	3 m	646840
 German	6	1U 19" aluminium	3.7 kW	3 m	646841
 Italian	6	1U 19" aluminium	3.7 kW	3 m	646842

METERED PDUs					
Socket standard	Number of sockets	Casing	Max. power	Cable length	Cat. Nos.
  IEC60320	12	1U 19" aluminium	3.7 kW	3 m	646010
	16 [12 C13 + 4 C19]	2U 19" aluminium	7.4 kW		646011
	22 [18 C13 + 4 C19]	Zero-U aluminium	3.7 kW		646012
	24 [20 C13+4 C19]		7.4 kW		646016
	42 [36 C13 + 6 C19]	Zero-U HD aluminium	7.4 kW		646013
	42 [36 C13 + 6 C19]		11 kW		646014
	48 [36 C13 + 12 C19]		22 kW		646015

SWITCHED PDUs					
Socket standard	Number of sockets	Casing	Max. power	Cable length	Cat. Nos.
  IEC60320	8	1U 19" aluminium	3.7 kW	3 m	646020
	16	2U 19" aluminium	7.4 kW		646021
	24 [21 C13 + 3 C19]	Zero-U aluminium	3.7 kW		646022
			7.4 kW		646023
			11 kW		646024
	16		2.3 kW		646025

BASIC PDUs					
Socket standard	Number of sockets	Casing	Max. power	Cable length	Cat. Nos.
 IEC60320	6	1U 19" aluminium	3.7 kW	cordless	646807
	10				646814
	12			646815	
	24	Zero-U aluminium	7.4 kW	3 m	646857
	8 (6 C13 + 2 C19)	1U 19" aluminium		cordless	646856
	24 (20 C13 + 4 C19)	Zero-U aluminium	7.4 kW	3 m	646861
	24 (18 C13 + 6 C19)		7.4 kW	cordless	646860
			11 kW	3 m	646870
 French/Belgian	4	1U 10" aluminium	3.7 kW	1 m	646800
	6	1U 19" aluminium		3 m	646805
					646830
					646833
					646835
	8	646822			
	9	646810			
		646811			
	646820				
24	Zero-U aluminium	7.4 kW	cordless	646851	
				646850	
 German	4	1U 10" aluminium	3.7 kW	1 m	646801
	6	1U 19" aluminium		3 m	646806
					646831
					646836
					646823
	8	646812			
	9	646821			
		2U 19" aluminium			646832
	646853				
24	Zero-U aluminium	7.4 kW	cordless	646852	
 English	6	1U 19" aluminium	3 kW	3 m	646824
	8				646813
	24	Zero-U aluminium		7.4 kW	cordless
 Italian	24	Zero-U aluminium	7.4 kW	3 m	646859
 Swiss	12 (T13)	1U 19" aluminium	3.7 kW	3 m	646818
	12 (T23)				646819

Legrand cabling system LCS³ Energy Distribution

single phase Zero-U Basic Power Distribution Units (PDU)

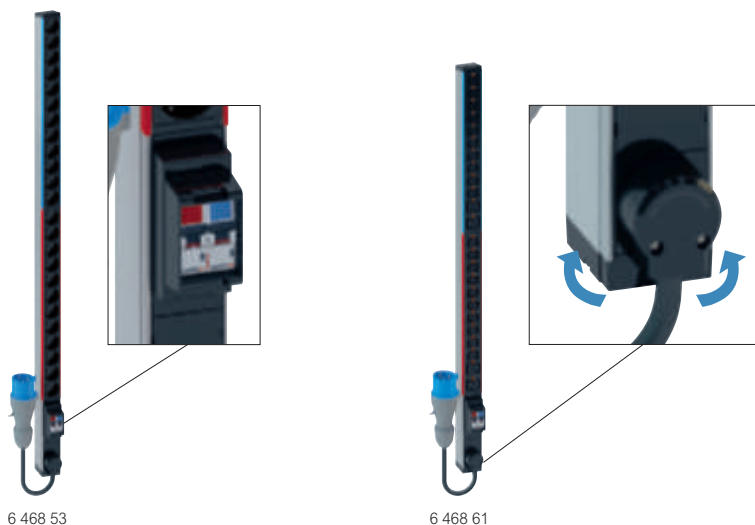

To provide ~ electric power for IT equipment in 19" enclosures
Single phase Zero-U PDUs for vertical mounting in the cabinet
230 V - 50/60 Hz power supply

PDUs with 2 circuits protected by 16 A uni + neutral MCB in a support with projecting edges to avoid accidental breakdown. Each circuit is identified by color coding. The total number of outlets is distributed equally between the 2 circuits. 2P+E outlets: C13 and C19 standard outlets, French/German/British standards outlets equipped with blanks, French/German standards outlets inclined at 55°

330° rotating cable input for a perfect orientation of the cable and no interference in the cabinet

C13 and C19 standard outlets are equipped with cord locking system to avoid any accidental disconnection. Universal solution compatible with all the cords (C14 plugs for C13 and C20 plugs for C19)

Delivered with 2 sets of metallic mounting brackets: button brackets (for quick fixing and variable pitch) and standard brackets (for screw fixing)

Black modules (outlets and functions)

Aluminium profile



Pack	Cat.Nos	PDU Basic	Pack	Cat.Nos	PDU Basic with ammeter
1	6 468 52	German standard 24 outlets Connection on terminal block up to 6 mm ²	1	6 468 65	 IEC 60320 standard Measure consumption to provide better installation management: balancing circuits, displaying available capacity, preventing overloads and power failures 1 ammeter per circuit Rotating display to ensure a perfect reading whatever the PDU mounting direction is (horizontal, vertical with top or bottom power supply input)
1	6 468 53	British standard 24 outlets Connection on terminal block up to 6 mm ²			
1	6 468 54	French standard 24 outlets Connection on terminal block up to 6 mm ²			
1	6 468 50	Italian standard 24 outlets 3 m power supply cord with IEC 60309 32 A 2P+E plug			
1	6 468 51	IEC 60320 standard 24 C13 outlets with cord locking system Connection on terminal block up to 6 mm ²			
1	6 468 59	24 outlets 3 m power supply cord with IEC 60309 32 A 2P+E plug			
1	6 468 56	24 outlets 3 m power supply cord with IEC 60309 32 A 2P+E plug			
1	6 468 57	24 C13 outlets with cord locking system			
1	6 468 60	20 C13 outlets + 4 C19 outlets with cord locking system. Connection on terminal block up to 6 mm ²			
1	6 468 61	20 C13 outlets + 4 C19 outlets with cord locking system. 3 m power supply cord with IEC 60309 32 A 2P+E plug			

Legrand cabling system LCS³ Energy Distribution - three phases Zero-U Basic PDUs



6 468 75

To provide ~ electric power for IT equipment in 19" enclosures
Three phases Zero-U PDUs for vertical mounting in the cabinet
400 V - 50/60 Hz power supply
Each circuit is protected by 16 A single pole MCB in a support with projecting edges to avoid accidental breakdown. 1 circuit per phase, each with 6 IEC 60320 C13 outlets and 2 IEC 60320 C19 outlets
330° rotating cable input for a perfect orientation of the cable and no interference in the cabinet
C13 and C19 standard outlets are equipped with cord locking system to avoid any accidental disconnection. Universal solution compatible with all the cords (C14 plugs for C13 and C20 plugs for C19)
Delivered with 2 sets of metallic mounting brackets: button brackets (for quick fixing and variable pitch) and standard brackets (for screw fixing)
Black modules (outlets and functions)
Aluminium profile

Pack	Cat.Nos	PDU Basic
1	6 468 70	 IEC 60320 standard 18 C13 outlets + 6 C19 outlets with cord locking system. 3 m power supply cord with IEC 60309 16 A 3P+N+E plug
1	6 468 75	PDU Basic with ammeter Measure consumption to provide better installation management: balancing circuits, displaying available capacity, preventing overloads and power failures 1 ammeter per circuit Rotating display to ensure a perfect reading whatever the PDU mounting direction is (horizontal, vertical with top or bottom power supply input)
1	6 468 75	 IEC 60320 standard 18 C13 outlets + 6 C19 outlets with cord locking system. 3 m power supply cord with IEC 60309 16 A 3P+N+E plug

CORD LOCKING SYSTEM

Innovation at the heart of PDUs to prevent accidental disconnection

A major addition to the range and exclusive to Legrand, C13 and C19 outlets have a power supply cord locking system which prevents accidental disconnection and guarantees absolute safety!



An innovative technical solution: very easy to identify thanks to the orange buttons next to each outlet



A universal system: takes all cords for standard C13 and C19 outlets

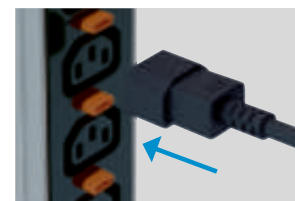

CONNECTION

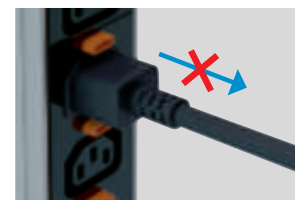

AUTO LOCKING

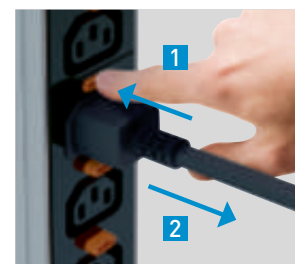

UNLOCKING

Legrand cabling system LCS³ Energy Distribution

Horizontal (1U/2U) Basic Power Distribution Units (PDU)

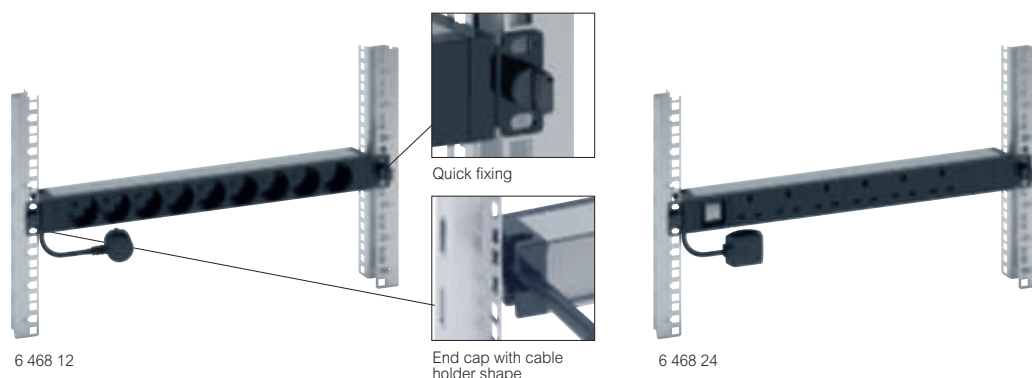

To provide ~ electric power for IT equipment in enclosure. 230 V - 50/60 Hz power supply. 1U aluminium profile. End cap with metallic brackets and cable holder shape. Quick fixing (no screws) on 19" fixing centers. Can also be installed vertically by reverting the brackets (no screws)

- 2P+E outlets:
- C13 and C19 standard outlets are equipped with cord locking system to avoid any accidental disconnection. Universal solution compatible with all the cords (C14 plugs for C13 and C20 plugs for C19).
 - French, German and British standard outlets are equipped with blanks
 - French and German standard outlets are inclined at 55°
- Black modules (outlets and functions)

Pack	Cat.Nos	19" - PDU Basic
		German standard
1	6 468 06	3 m power supply cord with 16 A 2P+E French/German plug
1	6 468 12	6 outlets
		9 outlets
		British standard
1	6 468 13	3 m power supply cord with 13 A 2P+E British plug
		8 outlets
		French standard
		3 m power supply cord with 16 A 2P+E French/German plug
1	6 468 05	6 outlets
1	6 468 10	9 outlets
1	6 468 11	9 tamperproof red outlets
		Swiss standard
		3 m power supply cord with 16 A 2P+E Swiss plug
1	6 468 18	12 T13
1	6 468 19	12 T23
		IEC 60320 standard
		Connection on terminal block (except Cat.No 6 468 15)
1	6 468 14	10 C13 outlets with cord locking system
1	6 468 15	12 C13 outlets with cord locking system
		3 m power supply cord with 16 A IEC 60309 2P+E
1	6 468 09	6 C13 outlets + 2 C19 outlets with cord locking system
1	6 468 07	6 C19 outlets with cord locking system

Pack	Cat.Nos	19" - PDU Basic with power indicator or luminous switch
		LED indicator: signals whether the PDU is supplied with power or not
		LED indicator switch: powers on/off the PDU
		German standard
		3 m power supply cord with 16 A 2P+E French/German plug
1	6 468 21	9 outlets and 1 power indicator
1	6 468 23	8 outlets and 1 luminous switch
		British standard
		3 m power supply cord with 13 A 2P+E British plug
1	6 468 24	6 outlets and 1 luminous switch
		French standard
		3 m power supply cord with 16 A 2P+E French/German plug
1	6 468 20	9 outlets and 1 power indicator
1	6 468 22	8 outlets and 1 luminous switch

Pack	Cat.Nos	10" - PDU Basic
		1 m power supply cord 2P+E French/German plug
		4 x 2P+E outlets
1	6 468 01	German standard
1	6 468 00	French standard

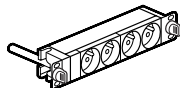

Legrand cabling system LCS³ Energy Distribution

1U Basic Power Distribution Units (PDU)



6 468 36

To provide ~ electric power for IT equipment in enclosures. 230 V - 50/60 Hz power supply. 1U aluminium profile. End cap with metallic brackets and cable holder shape. Quick fixing (no screws) on 19" fixing centers. Can also be installed vertically by reverting the brackets (no screws)
2P+E outlets:

- C13 and C19 standard outlets are equipped with cord locking system to avoid any accidental disconnection. Universal solution compatible with all the cords (C14 plugs for C13 and C20 plugs for C19).
 - French, German and British standard outlets are equipped with blanks
 - French and German standard outlets are inclined at 55°
- Black modules (outlets and functions)

Pack	Cat.Nos	19" - Basic PDU with protection devices
1	6 468 31	MCB and RCBO support with projecting edges to avoid accidental breakdown 3 m power supply cord with 16 A 2P+E French/German plug
1	6 468 32	German standard 6 outlets and a 16 A single pole Micro Circuit Breaker
1	6 468 30	French standard 9 outlets and a 16 A single pole Micro Circuit Breaker, 2U height
1	6 468 33	French standard 6 outlets and a 16 A 30 mA Residual-current Circuit
		19" - Basic PDU with surge protection
		Protect against mains overvoltages while keeping outlets energised With light indicators: - one LED (white) gives information whether the PDU is supplied with power or not - one LED (green) indicates when surge protection module is efficient or must be replaced Equipped with hotswappable surge protection module Cat.No 6 468 97: even when the module is being replaced, the PDU and its outlets are still powered on With switch 3 m power supply cord with 16 A 2P+E French/German plug
1	6 468 36	6 outlets - German standard
1	6 468 35	6 outlets - French standard

Pack	Cat.Nos	19" - Basic PDU with ammeter
		Measure consumption to provide better installation management: balancing circuits, displaying available capacity, preventing overloads and power failures Measure total PDU current Rotating display to ensure a perfect reading whatever the PDU mounting direction is (horizontal, vertical with top or bottom power supply input)
1	6 468 41	German standard 3 m power supply cord with 16 A 2P+E French/German plug 6 outlets
1	6 468 40	French standard 3 m power supply cord with 2P+E French/German plug 6 outlets
1	6 468 42	Italian standard 6 outlets
		IEC 60320 standard
		With integrated universal plug locking system Connection on terminal block
1	6 468 43	6 C13 outlets with cord locking system
1	6 468 45	6 C13 outlets + 1 C19 outlet with cord locking system
1	6 468 44	6 C19 outlets with cord locking system

Legrand cabling system LCS³ Energy Distribution

Intelligent metered and switched PDUs



Power distribution units with metering at inlet level and circuit breaker level
Possibility of environmental monitoring through one of the optional external sensors (temperature, humidity...)

Pack	Cat.Nos	19" - intelligent metered PDUs
1	6 460 10	IEC 60320 standard 12 C13 outlets, with 3 m power supply cord with C20 plug
1	6 460 11	12 C13 and 4 C19 outlets, with 3 m power supply cord with IEC60309 32 A 2P+E plug

Pack	Cat.Nos	19" - intelligent metered and switched PDUs
1	6 460 20	IEC 60320 standard 8 C13 outlets with cord locking system and switch 3 m power supply cord with C14 10/16 A 2P+E plug
1	6 460 21	16 C13 outlets with cord locking system and switch 3 m power supply cord with CEI 60309 32 A 2P+E plug

Pack	Cat.Nos	Vertical Zero-U - intelligent metered PDUs
1	6 460 12	IEC 60320 standard 18 C13 and 4 C19 outlets, with 3 m power supply cord with IEC60309 16 A 2P+E plug
1	6 460 13	36 C13 and 6 C19 outlets, with 3 m power supply cord with IEC60309 32 A 2P+E plug
1	6 460 14	36 C13 and 6 C19 outlets, with 3 m power supply cord with 3 phase IEC60309 16 A 3P+N+E plug
1	6 460 15	30 C13 and 12 C19 outlets, with 3 m power supply cord with 3 phase IEC60309 32 A 3P+N+E plug
1	6 460 16	20 C13 and 4 C19 outlets with 3 m power supply cord with IEC60309 32 A 2P+E plug

Pack	Cat.Nos	Vertical Zero-U - intelligent metered and switched PDUs
1	6 460 25	IEC 60320 standard 16 C13 outlets with cord locking system. 3 m power supply cord with C14 10 A 2P+E plug
1	6 460 22	21 C13 outlets and 3 C19 outlets with cord locking system. 3 m power supply cord with IEC 60320 16 A 2P+E plug
1	6 460 23	21 C13 outlets and 3 C19 outlets with cord locking system. 3 m power supply cord with IEC 60320 32 A 2P+E plug
1	6 460 24	21 C13 outlets and 3 C19 outlets with cord locking system. 3 m power supply cord with IEC 60309 16 A 3P+N+E plug

Pack	Cat.Nos	Sensors for metered PDU accessories
1	6 460 00	Temperature sensor
1	6 460 01	Temperature / humidity sensor
1	6 460 02	Dual contact closure sensor

Legrand cabling system LCS³ Energy Distribution

PDU's



6 468 90

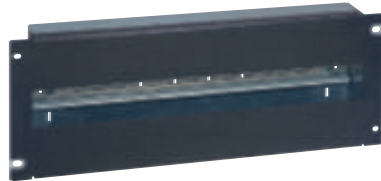

0 465 46 + 0 465 47

Pack	Cat.Nos	PDU to be equipped
1	6 468 99	For self assembly with Mosaic wiring device modules Quick fixing (no screws) on 19" uprights Aluminium profile PDU 19" Capacity: 16 Mosaic modules
1	6 468 98	PDU 10" Capacity: 8 Mosaic modules
PDU accessories		
Locking caps		
To block the use of an outlet. A key is necessary to remove the cap and free the access Light grey		
1	6 468 90	Set of 6 locking caps for French, Italian and German standard outlet + 1 key
1	6 468 92	Set of 6 locking caps for British standard outlet + 1 key
1	6 468 94	Set of 6 locking caps for C13 standard outlet + 1 key
1	6 468 95	Set of 6 locking caps for C19 standard outlet + 1 key
Surge protection module		
1	6 468 97	To replace used module on PDU With light indicators: - one LED (white): signals whether the PDU is supplied with power or not - one LED (green/red) indicates when surge protection module is active or must be replaced Hotswappable surge protection module: even when the module is being replaced, the PDU and its outlets are still powered on Surge protection replacement module

Pack	Cat.Nos	Multi-applications DIN rail
1	0 465 46	For mounting modular devices (circuit breakers, Legrand multimedia network components, etc) Capacity: 24 modules Height 4 U Screw fixing on 19" uprights DIN profile rail with front panel Supplied with blanking plates 24 modules Black RAL 9005
1	0 465 47	Rear cover To be used for high current applications (greater than 50 V) To be associated with DIN profile rail Cat.No 0 465 46 Ensures IP XXB Supplied with terminal block (8 + 1 connections)

Energy distribution

cord locking system

■ Cord locking system

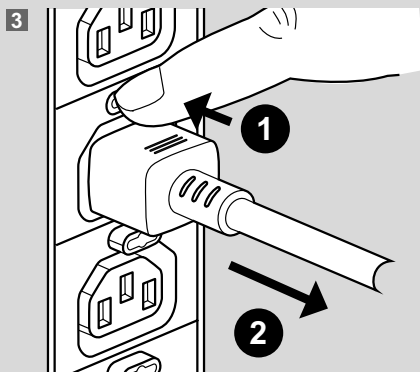
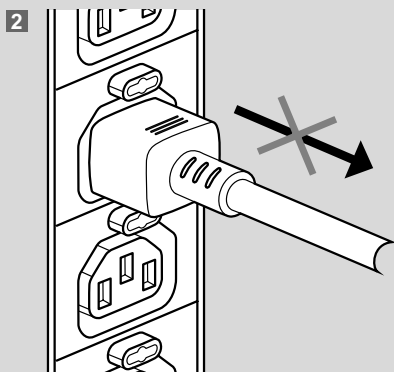
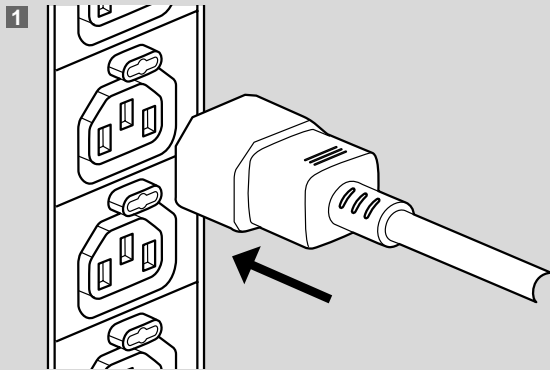

Energy distribution

19" 1U PDU mounting

■ Horizontal mounting in Legrand 19" cabinets

Can be mounted in all Legrand 19" cabinets except for 19" HD racks which require the use of equipment screws Cat.No 0 464 23

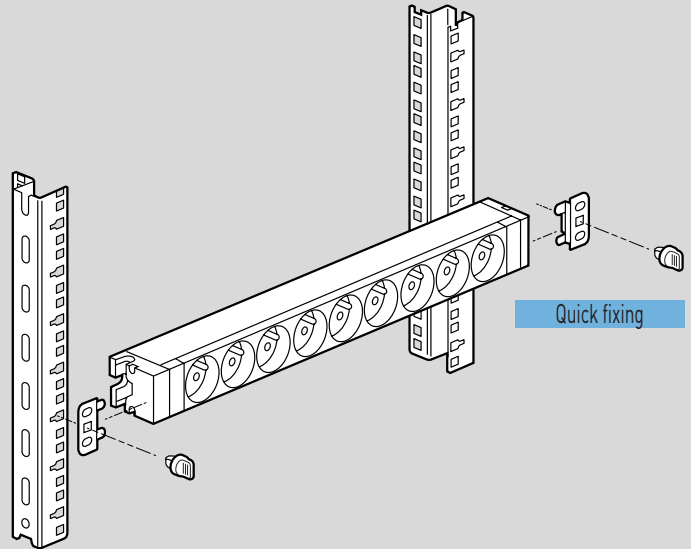

■ Vertical mounting in freestanding cabinets with support

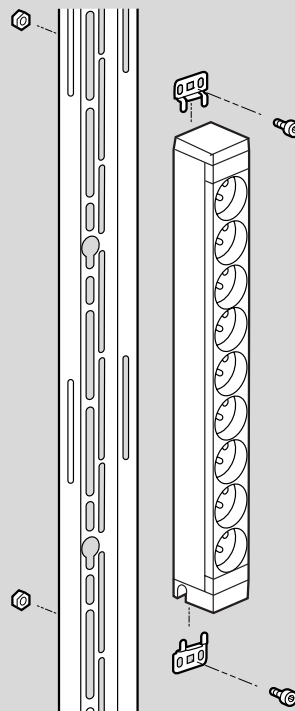

Energy distribution

19" 1U PDU mounting

19" 1U PDU configurations

6 468 05



6 468 06



6 468 07



6 468 09



6 468 10

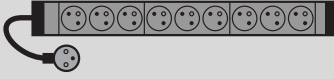

6 468 11



6 468 12

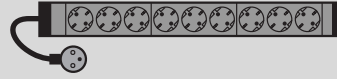

6 468 13



6 468 14



6 468 15



6 468 18/19



6 468 20



6 468 21



6 468 22

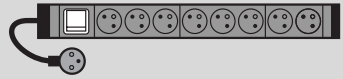

6 468 23



6 468 24



6 468 30



6 468 31

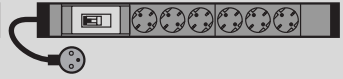

6 468 32

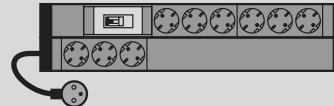

6 468 33



6 468 35



6 468 36



6 468 40



6 468 41



6 468 42



6 468 43



6 468 44



6 468 45



10" 1U PDU configurations

6 468 00

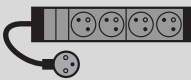

6 468 01

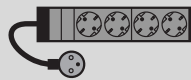

Energy distribution

Zero-U PDU

Zero-U PDU configurations

6 468 50 6 468 51 6 468 52 6 468 53 6 468 54 6 468 56 6 468 57 6 468 59 6 468 60 6 468 61 6 468 65 6 468 70 6 468 75

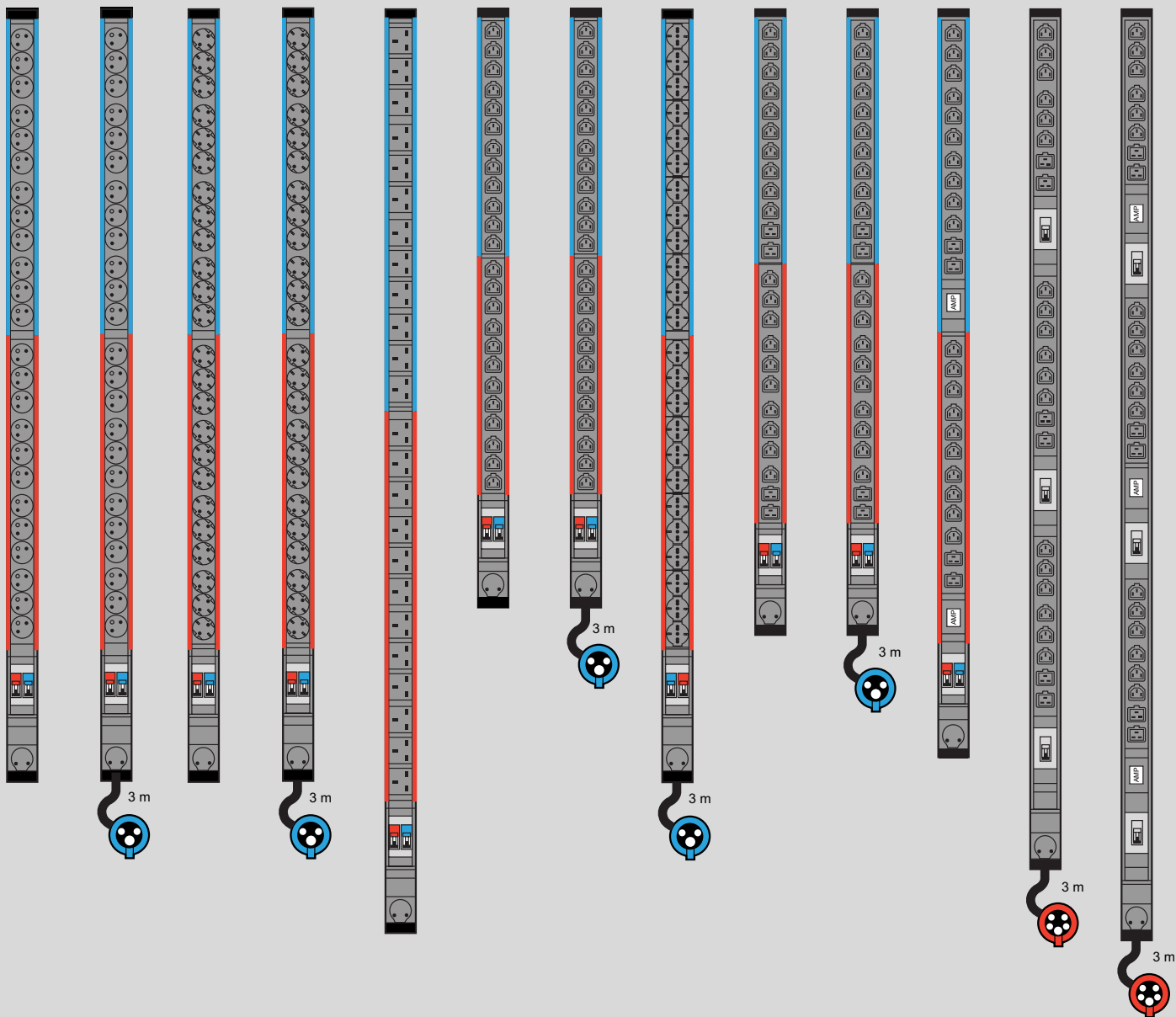

Zero-U PDU sizes (mm)

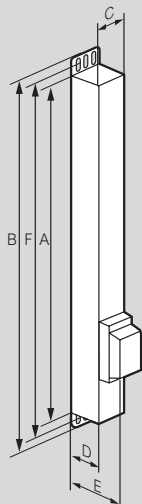

Cat.Nos	Height		Width C	Depth		Fixing centres (mini-maxi)	
	A	B ⁽¹⁾		D	E ⁽²⁾	F ⁽¹⁾	
6 468 50	1247	1291	52	52.5	87	1259	1279
6 468 51	1247	1291	52	52.5	87	1259	1279
6 468 52	1247	1291	52	52.5	87	1259	1279
6 468 53	1247	1291	52	52.5	87	1259	1279
6 468 54	1463	1507	52	52.5	87	1475	1495
6 468 56	1031	1075	52	52.5	87	1043	1063
6 468 57	1031	1075	52	52.5	87	1043	1063
6 468 59	1319	1363	52	52.5	87	1331	1351
6 468 60	1067	1111	52	52.5	87	1079	1099
6 468 61	1067	1111	52	52.5	87	1079	1099
6 468 65	1157	1201	52	52.5	87	1169	1189
6 468 70	1340	1384	52	52.5	87	1352	1372
6 468 75	1475	1519	52	52.5	87	1487	1507

1 : Overall height with standard brackets (screw fixing)
2 : Overall depth at the circuit breaker slot

Energy distribution

19" and Zero-U Intelligent PDUs

19" intelligent PDUs

6 460 10



6 460 11



6 460 20



6 460 21



Zero-U intelligent PDUs

6 460 12

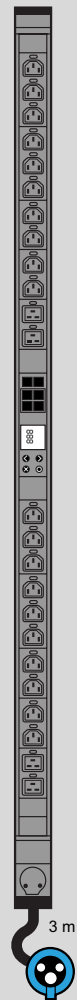

6 460 13

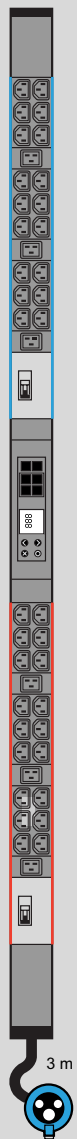

6 460 14



6 460 15

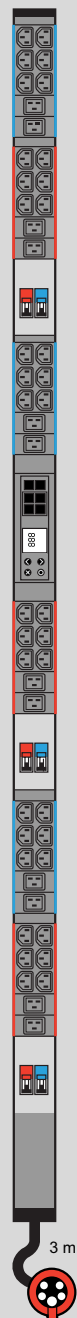

6 460 16



6 460 22



6 460 23

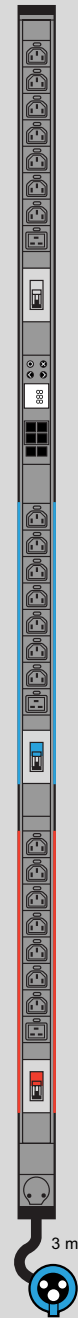

6 460 24



6 460 25

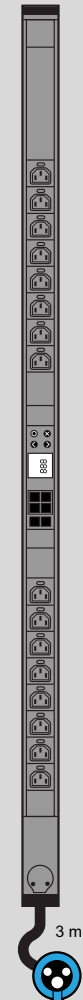

Zero-U intelligent PDUs sizes (mm)

Cat.Nos	Height		Width	Depth			Fixing centres (mini-maxi)	
	A	B ⁽¹⁾		C	D	E ⁽²⁾	F ⁽¹⁾	
6 460 12	1298	1342	52	52.5	-	1310	1330	
6 460 13	1539	1583	59	52.5	68	1551	1571	
6 460 14	1298	1342	59	52.5	-	1310	1330	
6 460 15	1780	1824	59	52.5	68	1792	1812	
6 460 16	1475	1519	52	52.5	68	1487	1507	

Cat.Nos	Height		Width	Depth			Fixing centres (mini-maxi)	
	A	B ⁽¹⁾		C	D	E ⁽²⁾	F ⁽¹⁾	
6 460 22	1539	1583	52	52.5	-	1551	1571	
6 460 23	1780	1824	52	52.5	68	1792	1812	
6 460 24	1539	1583	52	52.5	-	1551	1571	
6 460 25	1298	1342	52	52.5	-	1310	1330	

1 : Overall height with standard brackets (screw fixing) / 2 : Overall depth at the circuit breaker slot

Energy distribution

Zero-U PDU mounting in LCS³ cabinets

■ Solution with button brackets

Quick fixing without screws with support

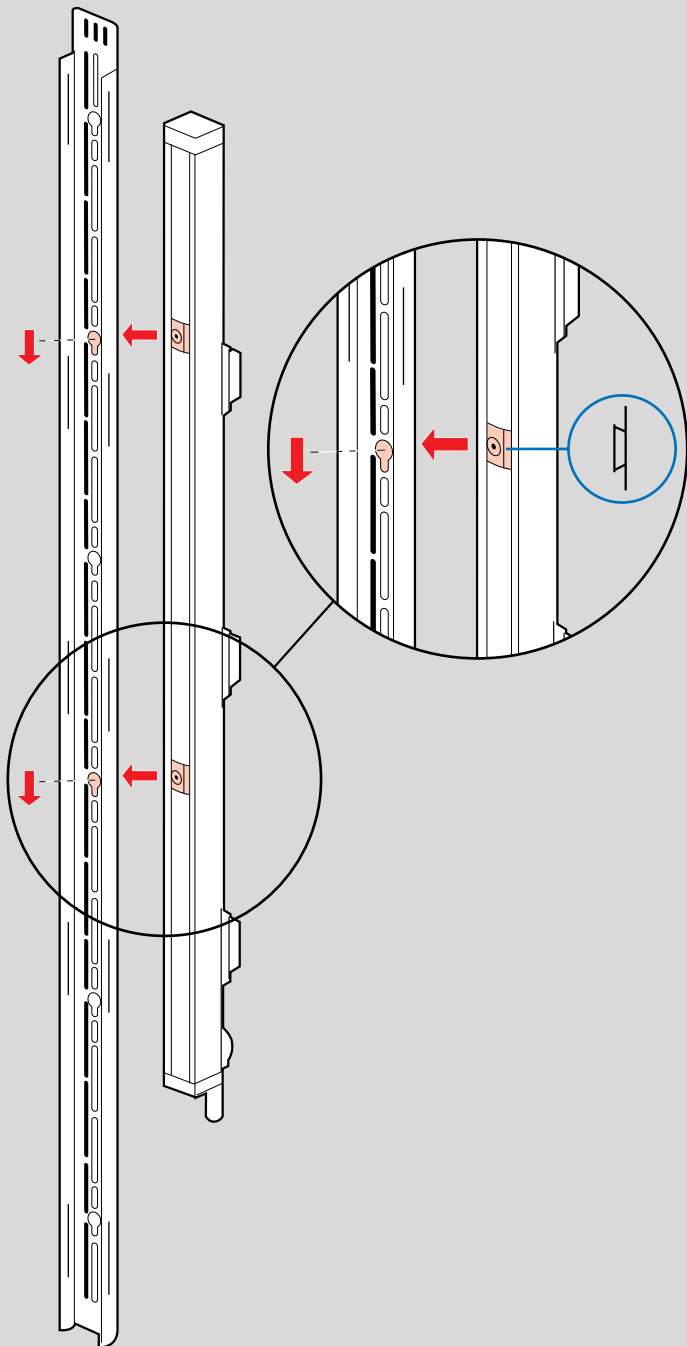

■ Solution with standard brackets

Screw fixing with support

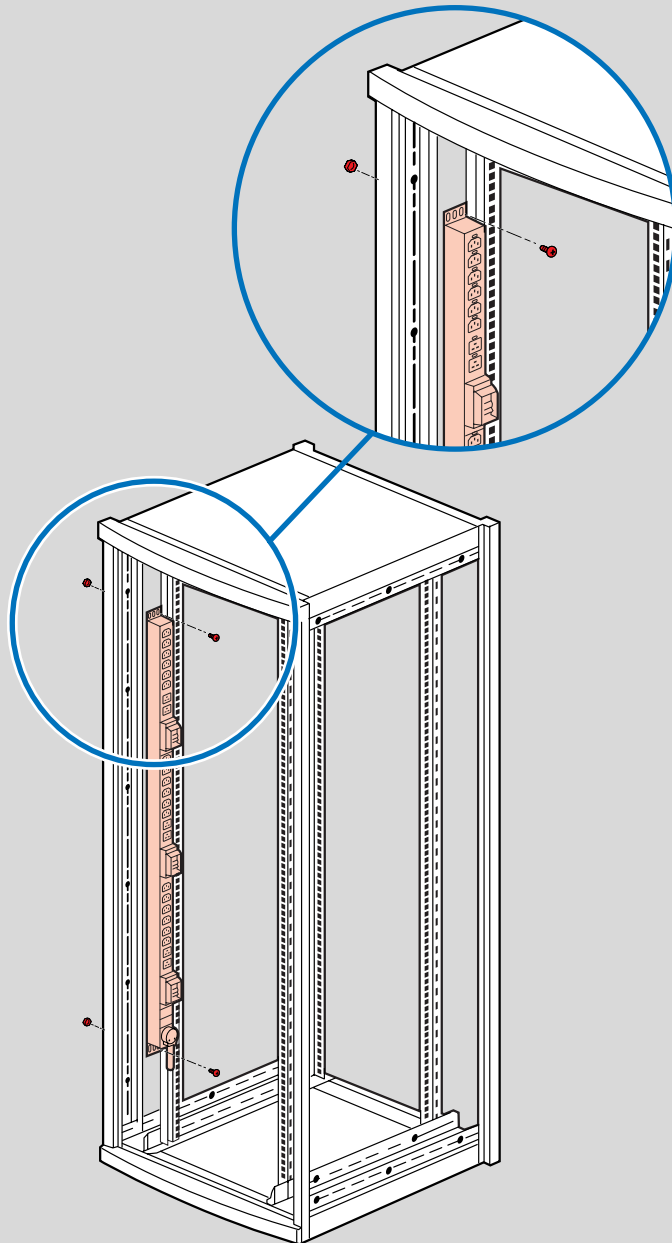

Catalogue number index

■ Solution with LCS³ brackets

Screw fixing with support

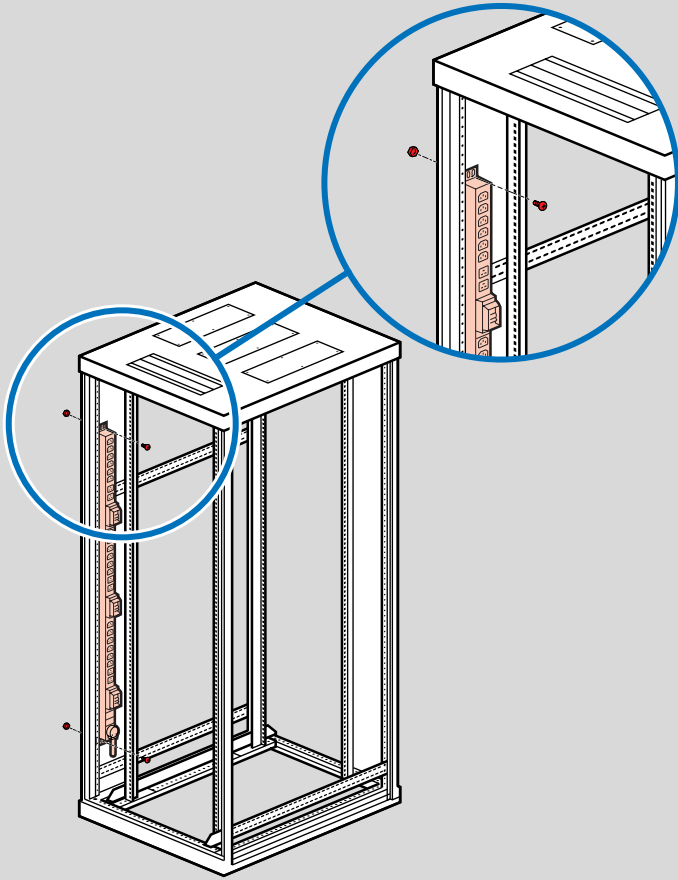

Cat.Nos	Page N°	Pack
0 465 00		
0 465 46	31	1
47	-	1
6 460 00		
6 460 00	30	1
01	-	1
02	-	1
10	-	1
11	-	1
12	-	1
13	-	1
14	-	1
15	-	1
16	-	1
20	-	1
21	-	1
22	-	1
23	-	1
24	-	1
25	-	1
6 468 00		
6 468 00	28	1
01	-	1
05	-	1
06	-	1
07	-	1
09	-	1
10	-	1
11	-	1
12	-	1
13	-	1
14	-	1
15	-	1
18	-	1
19	-	1

Cat.Nos	Page N°	Pack
6 468 20	28	1
21	-	1
22	-	1
23	-	1
24	-	1
30	-	1
31	-	1
32	-	1
33	-	1
35	-	1
36	-	1
40	29	1
41	-	1
42	-	1
43	-	1
44	-	1
45	-	1
50	26	1
51	-	1
52	-	1
53	-	1
54	-	1
56	-	1
57	-	1
59	-	1
60	-	1
61	-	1
65	-	1
70	27	1
75	-	1
90	31	1
92	-	1
94	-	1
95	-	1
97	-	1
98	-	1
99	-	1



FOLLOW US
ON

@ www.legrand.com

 www.youtube.com/legrand

 twitter.com/legrand_news

EX219001 - January 2019



Head Office

and International Department
87045 Limoges Cedex - France

☎ : +33(0)5 55 06 87 87

Fax: +33(0)5 55 06 74 55