

Classe 300EOS with Netatmo touch screen handsfree video internal unit with Wi-Fi

344842

Description

2 wires/Wi-Fi handsfree connected video internal unit with built-in* Amazon Alexa voice assistant, 5" vertical touch screen LCD display and video door entry answering machine. It has a physical key for door lock release and capacitive keys for the control of the main video door entry functions: handsfree communication, entrance panel activation / camera scrolling and Favourite key (can be configured to activate the quick actions most frequently used – e.g. additional door locks, staircase light control, intercom). There are notification LEDs for: Wi-Fi network connection status, info / notifications and call exclusion.

It is possible to easily interact with the built-in Alexa voice assistant, either using the dedicated capacitive keys or with your voice, and activate several functions, such as the video door entry functions, smart home, scenarios, reminders etc.

Using the touch display, it is possible to access the notification list, as well as your favourite door entry and security controls (if any). Possibility of voice communication with the switchboard - if present in the system - after a specific call.

The device must be configured by physically connecting the configurators, or using the menu, which will give better possibilities of customisation of associated functions and texts. Thanks to the Wi-Fi connection, you can associate the video internal unit to the Home + Security App (available for Android and iOS). The App allows to use the main video internal unit functions (receiving calls, door lock release, display of the event timeline and activation of the entrance panel/camera cycling). With the Home + Security App, it is also possible to manage the products of the Netatmo Security range (outdoor and indoor cameras, door and window sensors, indoor siren, smoke detector). This allows you to quickly and easily create a Smart security system.

Wall mounted installation using the supplied bracket Possibility of Wi-Fi connection or using RJ45 ethernet cable with the dedicated accessory 344844.

(*) Alexa is not available in all languages and all countries. The features and functions of Alexa may vary depending on location.

Related items

344844 Accessory for connections using the ethernet cable RJ45

Technical data

Operating temperature:	5 – 40 °C
Power supply voltage from BUS-AV:	21 – 27 V
Additional power supply from 1-2:	27 V
Maximum BUS-AV absorption in operation:	580 mA
Maximum BUS-AV absorption when powered by clamp 1-2:	22 mA
Maximum cable section for each clamp:	2 x 1 mm ²
Maximum distance to be able to use Alexa:	5 m in optimum ambient audio condition

Wireless device in compliance with 802.11b/g/n standard, supports 2.4 GHz Wi-Fi band; transmission power < 20 dBm. WEP/WPA/WPA2 safety protocol.

Front view

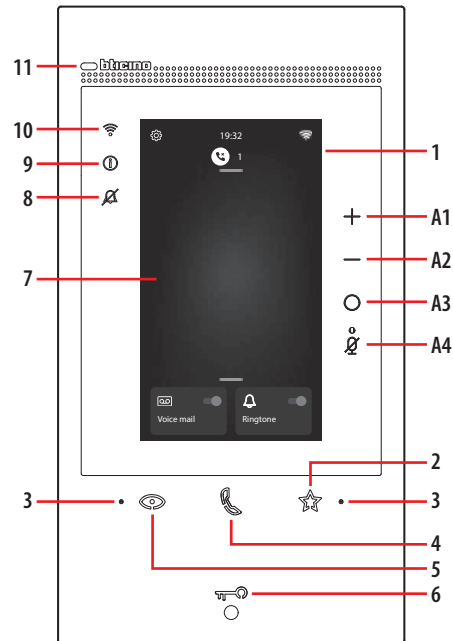

Legend

1. 5" vertical touch screen display
 2. "Favourites" touch key
 3. Microphone
 4. Touch key for answer:
 - Green LED flashing: incoming call
 - Green LED steady: communication in progress
 5. Entrance panel/scrolling activation touch key
 6. Door release key:
 - White LED steady: communication in progress
 - White LED flashing for 2 seconds: active "Safe Door Wock" function, deactivated key
 - White LED steady for 2 seconds and audible warning: door opening
 - White LED flashing (sequence of 2 short flashing): Door open* or Professional Studio active
 7. HomePage
 8. Bell exclusion notification LED
 - Red LED flashing: bell excluded
 9. Notification LED:
 - yellow LED: notifications from Alexa
 - white LED: answer machine messages or firmware updates
 10. Wi-Fi signal notification LED:
 - Red LED flashing: WI-FI on but not connected to the network
 - LED off: WI-FI disabled or working correctly
 - Red LED steady: forwarding of call , automatic switching on or "Call home" function in progress from Home + Security App
 11. Proximity sensor
- * only available with actuator 346260

Alexa control keys

- | | |
|----|---|
| A1 | Key used to increase the volume |
| A2 | Key used to decrease the volume |
| A3 | Alexa enabling key |
| A4 | "Mute" key, to disable both Alexa and device microphone |

Note: once powered, the device takes up to 2 minutes to be available for use.

Rear view

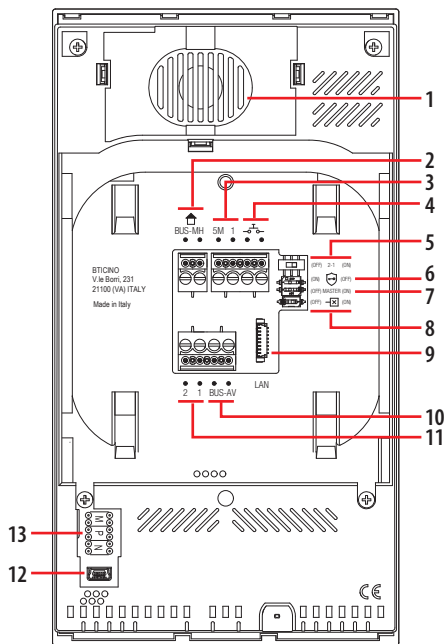

Legend

1. Speaker
2. Clamps for connection to the BUS MH (MyHOME) (future application)
3. Additional bell connection clamps (5M – 1).
The connection must be point - point on the clamps of the additional bells
4. Clamps for the connection of an external call to the floor pushbutton
5. Micro-switch to enable the additional power supply *
6. Micro-switch for "Safe door lock" function *
7. Micro-switch for "Master" function *
8. Line termination micro-switch *
9. LAN connector
For connection using RJ45 cable, use accessory 344844 (not supplied)
10. Clamps for connection to the AV BUS (audio video)
11. Additional power supply clamps (2– 1)
12. Service USB interface
13. Configurator socket

* ON = enabled

OFF = disabled

To activate the function with device not powered

Dimensional data

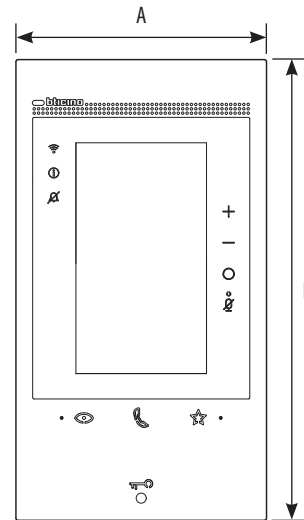

A	B	C
122 mm	222 mm	32 mm

Configuration

It is recommended to configure the device using the appropriate menu (see the User and installation manual).

Alternatively, it is also possible to use physical configurators as shown below.

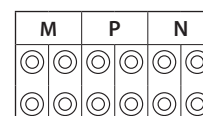

MM = Mode of operation according to the tables on the following pages.

PP = Address of the EP of which you can open the Door Lock with Handset idle, and to which you can send the auto-on command.

NN = Device address.



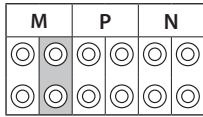



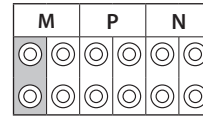









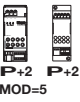

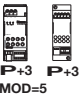



Physical configuration







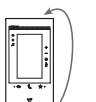



The functions that can be attributed to the Preferred key (★) using the physical procedure configurator inserted in the MM - (units) socket are the following:

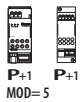

The MM (tens) physical configurator defines which 4 actions can be completed from the EDIT FAVORITES menu. The possible configurations are shown in the following table.

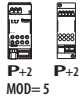
MM = 	Staircase Light Control	
MM = 	Direct control of P+1 Door lock	 P+1  P+1 P+1 MOD=5
MM = 	Direct control of P+2 Door lock	 P+2  P+2 P+2 MOD=5
MM = 	Direct control of P+3 Door lock	 P+3  P+3 P+3 MOD=5
MM = 	P+1 direct auto-switching on	 P+1  P+1 P+1 MOD=9
MM = 	P+2 direct auto-switching on	 P+2  P+2 P+2 MOD=9
MM = 	P+3 direct auto-switching on	 P+3  P+3 P+3 MOD=9
MM = 	Paging	
MM = 	Internal intercom	
MM = 	Enabling/disabling Office function	

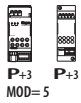

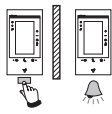
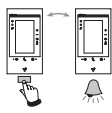
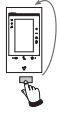
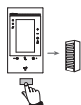

LEGEND

 P+1 MOD=9	Activating the EP (configured with P+1) directly without the call or activating actuator 346210 (configured with P+1 and MOD=9)
 P+1  P+1 P+1 MOD=5	Door lock opening of EP (configured with P+1) directly without the call or activating the actuator 346210 (configured with P+1 and MOD=5) or activating the actuator 346230 (configured with P+1)
 P+2  P+2 P+2 MOD=5	Door lock opening of EP (configured with P+2) directly without the call or activating the actuator (configured with P+2 and MOD=5) or activating the actuator 346230 (configured with P+2)
 P+3  P+3 P+3 MOD=5	Door lock opening of EP (configured with P+3) directly without the call or activating the actuator 346210 (configured with P+3 and MOD=5) or activating the actuator 346230 (configured with P+3)
 P+4  P+4 P+4 MOD=5	Door lock opening of EP (configured with P+4) directly without the call or activating the actuator 346210 (configured with P+4 and MOD=5) or activating the actuator 346230 (configured with P+4)
	Intercommunicability between apartments in systems with apartment interface 346850
	Intercommunicability inside an apartment in systems with apartment interface 346850 or intercommunicability between apartments in systems without apartment interface
	Intercom on itself, sends the call to all the devices with the same address
	Paging, it makes general intercom and sends a call to all the handsets of the system

**Class 300EOS with Netatmo
touch screen handsfree video internal unit
with Wi-Fi**

344842

MOD = MM

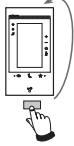
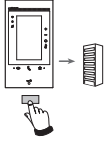
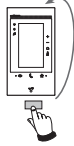
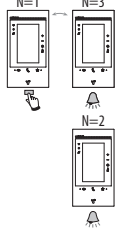
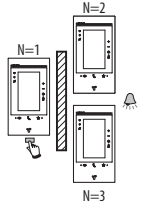
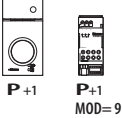
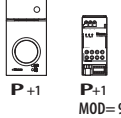
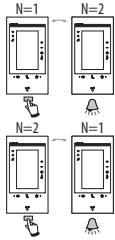
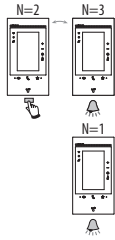
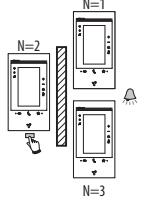
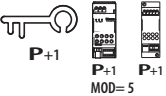
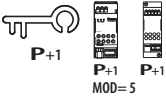
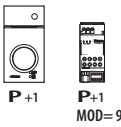
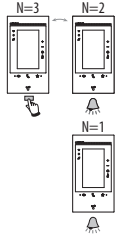
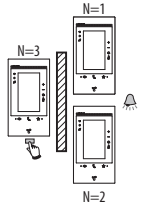
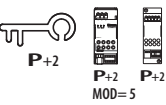
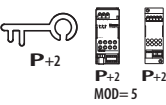
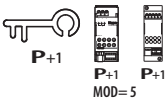
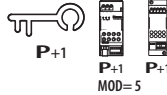
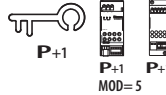
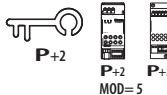
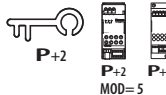



				
				
				
				
				
				

When configuring the device, wait one minute before connecting it to the system again.

Class 300EOS with Netatmo
touch screen handsfree video internal unit
with Wi-Fi

344842

MOD = MM

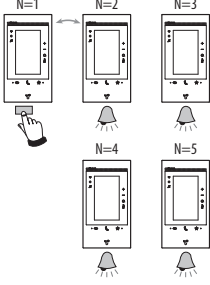
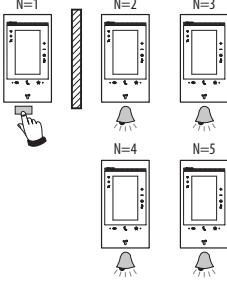
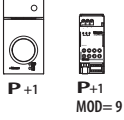
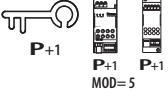
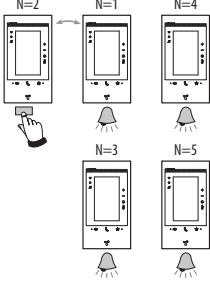
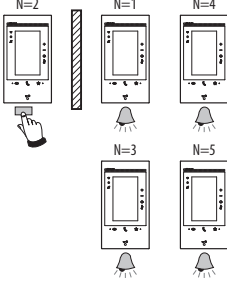
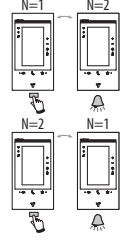
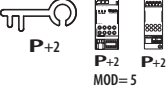
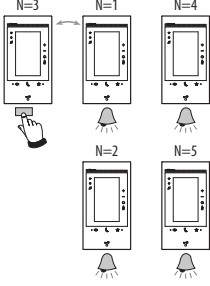
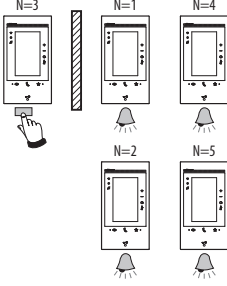
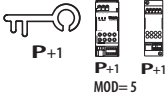
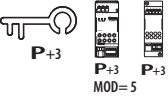
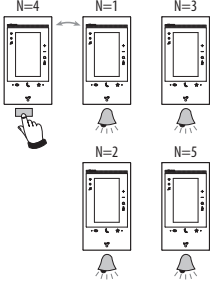
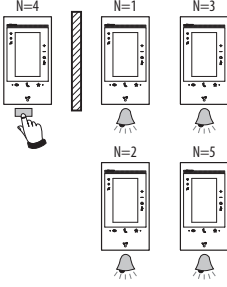
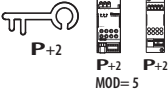
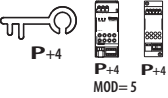
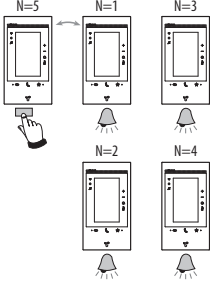
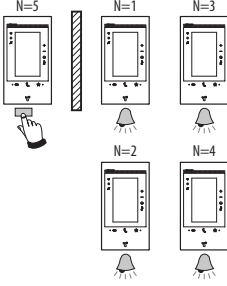
When configuring the device, wait one minute before connecting it to the system again.

Classe 300EOS with Netatmo touch screen handsfree video internal unit with Wi-Fi

344842

Maximum distances and cable features

CAUTION: The use of conductors with characteristics other than the prescribed ones does NOT guarantee correct performance of the system and good quality of the video signal.

Single family video systems made only with Classe 100 and Classe 300EOS with Netatmo Internal Units

Cable section mm ²	2 normal cables > 0.2 mm ²	Bticino cable 336904 0.5 mm ²	Telephone twisted pair 0.28 mm ²	Bticino cable C9881U/5E AWG24 cable or UTP5 cable	Bticino cable 336904/336905 0.5 mm ²	One PTT 278 TP 0.28 mm ²	OneSYT +Digital TP 5/10	OneSYT +Num TP 5/10	GIGA TW CAT5E AWG24	OneSYT +Num TP 8/10	Cable ARB.6060-1 6/10	Cable EV6R 6/10	1 mm ²
Max. distance Entrance Panel - Internal Unit	50 m	140 m	145 m	200 m	200 m		145 m	200 m	50 m				-
Max. distance Entrance Panel - Power supply	50 m	115 m	80 m	200 m	115 m		80 m	200 m	50 m				-
Max. distance Power supply - Internal Unit	25 m	50 m	30 m	110 m	50 m		30 m	110 m	25 m				-
Max. distance Entrance Panel - Door lock	30 m	30 m	-	50 m	30 m		-	-	-				100 m

- In systems where the EP is replaced by apartment interface 346850, and where the distance Entrance Panel - Power Supply is less than 1 m, the distance Power Supply - Internal Unit can reach the maximum distance of 200 m when using the 336904/336905 cable.

Multi-family video systems made only with Classe 100 and Classe 300EOS with Netatmo Internal Units

Max. distance Entrance Panel - Furthest Internal Unit

Cable section mm ²	2 normal cables > 0.2 mm ²	Bticino cable 336904/336905 0.5 mm ²	Telephone twisted pair 0.28 mm ²	A pair of the multi-pair data cable CAT5
2 IU/2 pushbuttons	50 m	200 m	140 m	180 m
5 IU/5 pushbuttons	50 m	200 m	140 m	155 m
10 IU/10 pushbuttons	50 m	200 m	140 m	145 m
26 IU/26 pushbuttons	50 m	200 m	140 m	125 m
38 IU/38 pushbuttons	50 m	200 m	140 m	110 m
38 IU/ display call	50 m	200 m	140 m	115 m
64 IU/ display call	50 m	200 m	140 m	-

Max. distance Entrance Panel - Power supply

Cable section mm ²	2 normal cables > 0.2 mm ² or L4669	Bticino cable 336904/336905 0.5 mm ²	Telephone twisted pair 0.28 mm ²	A pair of the multi-pair data cable CAT5
2 pushbuttons	50 m	200 m	130 m	95 m
5 pushbuttons	50 m	190 m	120 m	85 m
10 pushbuttons	50 m	180 m	110 m	80 m
26 pushbuttons	50 m	150 m	100 m	70 m
38 pushbuttons	50 m	140 m	90 m	65 m
Display call	50 m	150 m	95 m	65 m

Max. distance Power Supply - Furthest Internal Unit

Cable section mm ²	2 normal cables > 0.2 mm ²	Bticino cable 336904/336905 0.5 mm ²	Telephone twisted pair 0.28 mm ²	A pair of the multi-pair data cable CAT5
2 IU IN/OUT	50 m	200 m	140 m	95 m
5 IU IN/OUT	50 m	200 m	135 m	90 m
10 IU IN/OUT	50 m	190 m	130 m	85 m
10 IU IN/OUT	50 m	170 m	120 m	75 m
5 HA (SHUNTED)	50 m	200 m	110 m	80 m
10 HA (SHUNTED)	50 m	175 m	100 m	70 m
26 HA (SHUNTED)	50 m	145 m	80 m	60 m
38 HA (SHUNTED)	50 m	125 m	70 m	50 m
64 HA (SHUNTED)	-	95 m	55 m	-

Max. distance Entrance Panel - Door lock

Cable section mm ²	0.28 mm ²	Bticino cable L4669 0.35 mm ²	Bticino cable 336904/336905 0.5 mm ²	1 mm ²
(S+/S-) clamps	30 m	30 m	50 m	100 m

- Risers with max 26 internal units should be made in systems with more than 26 internal units

- Classe 300EOS with Netatmo always with additional power supply 1-2

- To ensure the correct operation of the system, we recommend the use of the YouDiagram software, which can be downloaded free of charge from www.professionisti.bticino.it

Wiring diagrams

Below are some examples of connection of the Classe 300EOS with Netatmo 344842 video handset in multi-family 2 wire video door entry systems.

DIAGRAM 1 - EXAMPLE OF MULTI-FAMILY SYSTEM WITH POWER SUPPLY

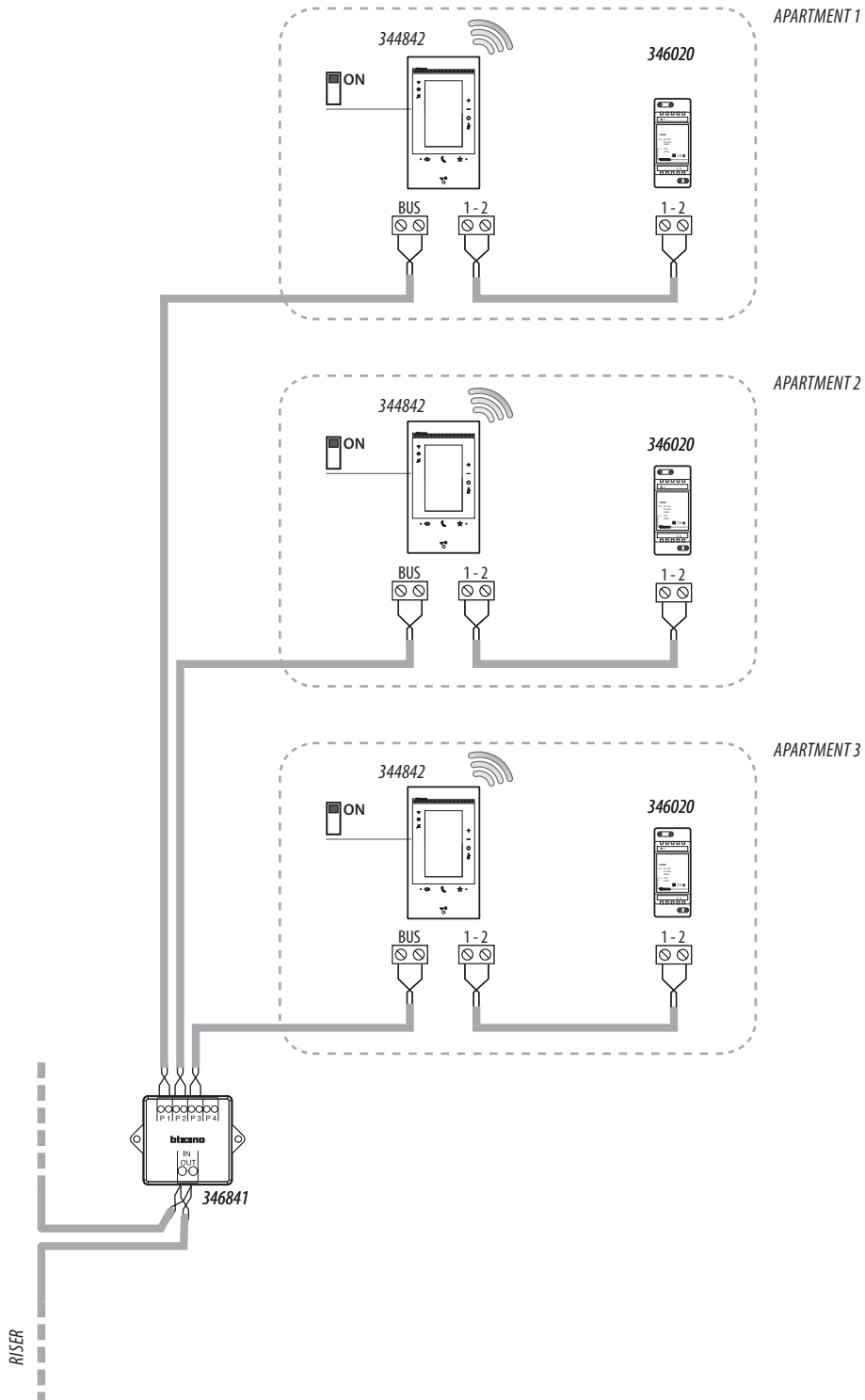

Note:

- additional powersupply is mandatory;
- Classe 300EOS with Netatmo has to be installed only in installation tottally 2wire technology.

DIAGRAM 2 - EXAMPLE OF MULTI-FAMILY SYSTEM WITH ADDITIONAL INTERNAL UNITS AND POWER SUPPLY

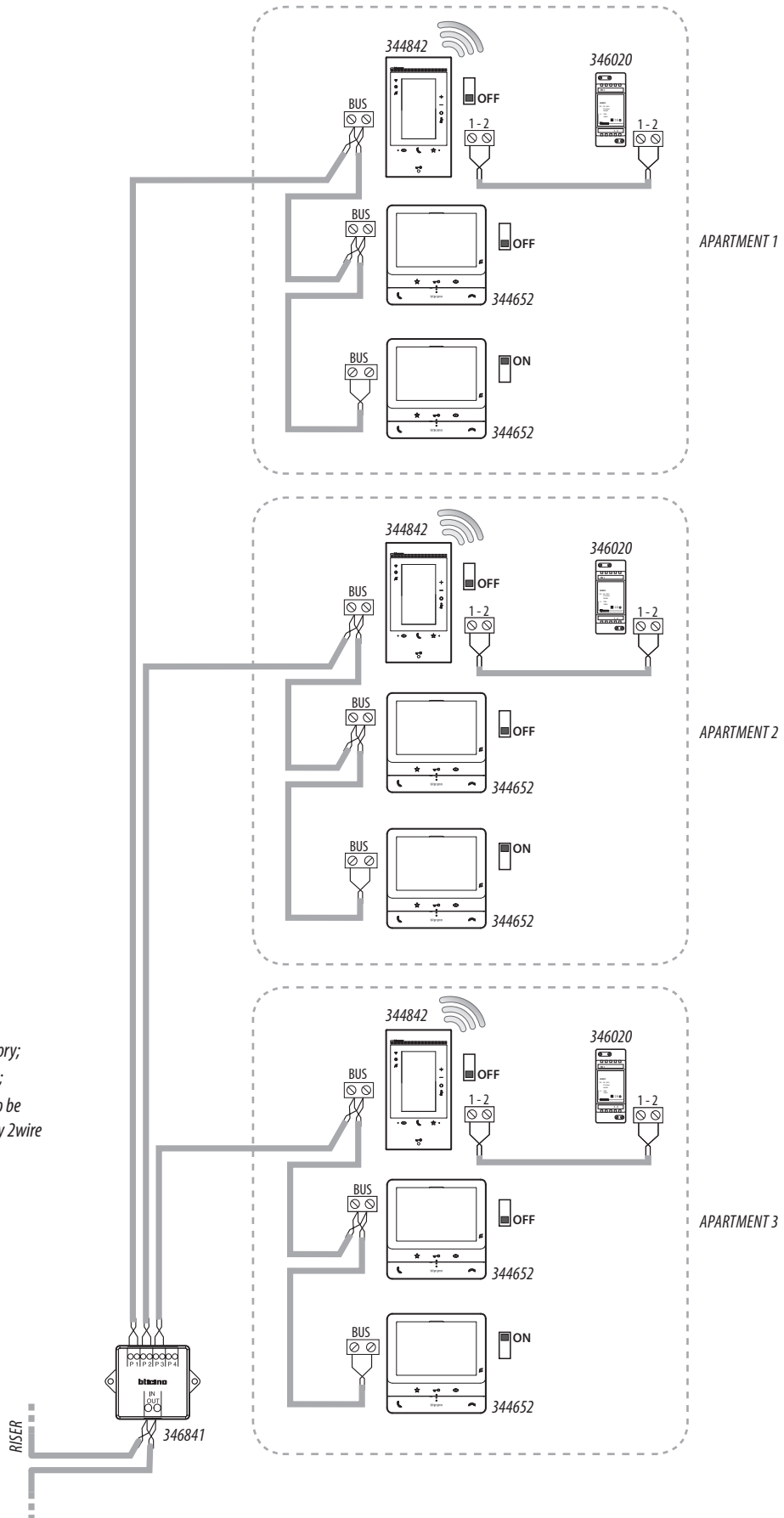

Note:

- additional powersupply is mandatory;
- max 3 internal units for apartment;
- Classe 300EOS with Netatmo has to be installed only in installation tottally 2wire technology.

DIAGRAM 3 – EXAMPLE OF A MULTI-FAMILY SYSTEM WITH ADDITIONAL INTERNAL UNITS, WITHOUT ADDITIONAL POWER SUPPLY AND WITH AUDIO/VIDEO NODE

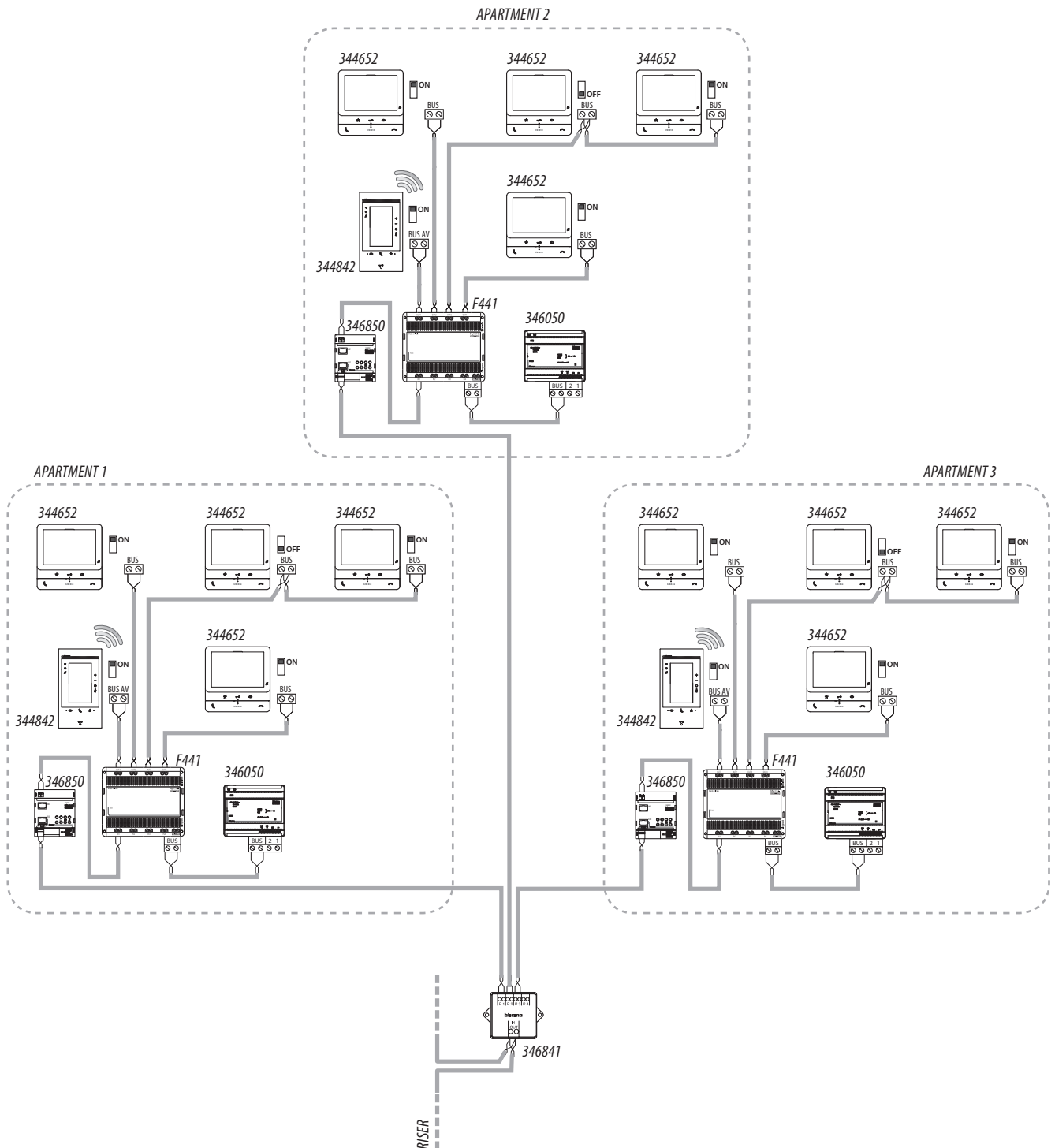

Note:

- additional powersupply is not necessary;
- max 5 internal units for apartment;
- Classe 300EOS with Netatmo has to be installed only in installation tottally 2wire technology.

DIAGRAM 4 - EXAMPLE OF SINGLE-FAMILY DIAGRAM

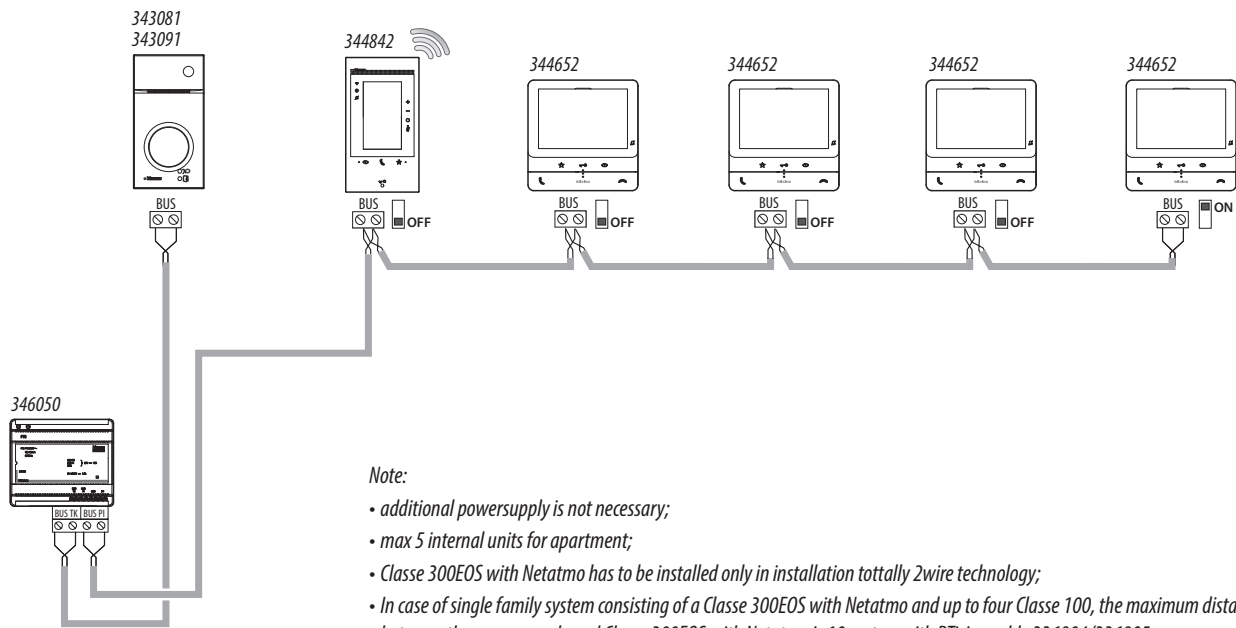
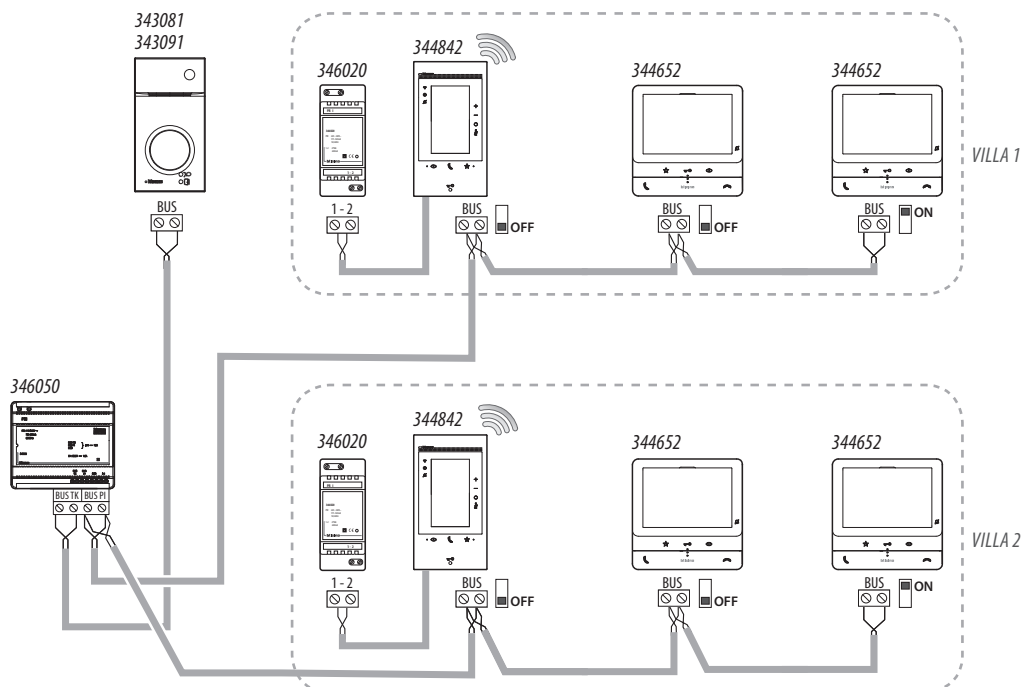

DIAGRAM 5 - EXAMPLE OF TWO-FAMILY DIAGRAM



Nota:

- max 3 internal units for apartment;
- Classe 300EOS with Netatmo has to be installed only in installation tottally 2wire technology.

Main functions

From the Home Page of the device, it is possible to access the main functions, as described below:



The video handset offers the possibility to select among 6 types of bells with programmed ringtones, which can be freely associated to the following type of calls:

- Call from the entrance panel** (configured with S=0)
- Call from the entrance panel** (configured with S=1)
- Call from the entrance panel** (configured with S=2)
- Call from the entrance panel** (configured with S=3)
- Intercom call within the apartment**
- Intercom call outside the apartment**
- Floor call**

The association of the type of ringtone to the event is performed using the dedicated menu on the device.

Using the advanced configuration, the video handset gives the possibility of programming up to:

- 50 generic activations**
- 50 direct activations to the door locks**
- 40 intercoms within the apartment**
- 40 intercoms outside the apartment**
- 50 direct auto-switching on to the EP**

Video door entry answering machine

The video door entry answering machine allows (if enabled) to display a video message recorded by the visitor.

It is also possible to record an audio message to play back on the entrance panel in case of unanswered call.

Intercom function

The intercom function allows for up to 3-minute communication between and among video door entry systems in the same apartment / in different apartments.

Door state function

This function indicates the status of the door lock (only for systems preset with appropriate actuator). If open the „door lock LED“ flashes, and if closed, the LED stays off. The function cannot be activated together with the Office function.

Office function

The Office function gives the possibility of setting the automatic opening of the door lock in case of call from the Entrance Panel. It cannot be activated at the same time as the Door Status function. The door lock key flashing (🔑🔊) indicates that the functions is active.

Paging function

This function can be used to send voice messages using the microphone of the device through the speakers of the sound system. To activate the function touch the appropriate icon on the Intercom menu. The green “Connection” LED on indicates that the function is active. To disable the function press the “Connection” key.