

PacT Series

ComPacT NSXm Circuit Breakers, Earth-Leakage Circuit Breakers, and Switch-Disconnectors

User Guide

PacT Series offers world-class breakers and switches

DOCA0185EN-00
01/2021



Legal Information

The Schneider Electric brand and any trademarks of Schneider Electric SE and its subsidiaries referred to in this guide are the property of Schneider Electric SE or its subsidiaries. All other brands may be trademarks of their respective owners.

This guide and its content are protected under applicable copyright laws and furnished for informational use only. No part of this guide may be reproduced or transmitted in any form or by any means (electronic, mechanical, photocopying, recording, or otherwise), for any purpose, without the prior written permission of Schneider Electric.

Schneider Electric does not grant any right or license for commercial use of the guide or its content, except for a non-exclusive and personal license to consult it on an "as is" basis. Schneider Electric products and equipment should be installed, operated, serviced, and maintained only by qualified personnel.

As standards, specifications, and designs change from time to time, information contained in this guide may be subject to change without notice.

To the extent permitted by applicable law, no responsibility or liability is assumed by Schneider Electric and its subsidiaries for any errors or omissions in the informational content of this material or consequences arising out of or resulting from the use of the information contained herein.

Table of Contents

| | |
|---|-----|
| Safety Information..... | 5 |
| About the Book..... | 6 |
| Presentation..... | 7 |
| PacT Series Master Range..... | 8 |
| Feature Overview..... | 9 |
| Device Overview..... | 10 |
| Circuit Breakers: Thermal Magnetic (TM-D) Protection..... | 14 |
| Earth-Leakage Circuit Breakers: Thermal Magnetic and Earth-Leakage Protections..... | 15 |
| Switch-Disconnectors..... | 23 |
| Environmental Conditions..... | 24 |
| Insulation Requirements and Accessories..... | 27 |
| Insulation Accessories..... | 28 |
| Clearance Requirements for ComPacT NSXm Circuit Breakers..... | 30 |
| Operation..... | 34 |
| Operating a Circuit Breaker with Toggle Handle..... | 35 |
| Description..... | 36 |
| Opening, Closing, Resetting, and Testing the Circuit Breaker..... | 38 |
| Locking the Circuit Breaker..... | 41 |
| Operating a Circuit Breaker with Direct Rotary Handle..... | 42 |
| Description..... | 43 |
| Opening, Closing, Resetting, and Testing the Circuit Breaker..... | 45 |
| Locking the Circuit Breaker..... | 48 |
| Operating a Circuit Breaker with Front Extended Rotary Handle..... | 51 |
| Description..... | 52 |
| Opening, Closing, Resetting, and Testing the Circuit Breaker..... | 53 |
| Locking the Circuit Breaker..... | 57 |
| Operating a Circuit Breaker with Side Rotary Handle..... | 60 |
| Description..... | 61 |
| Opening, Closing, Resetting, and Testing the Circuit Breaker..... | 62 |
| Locking the Circuit Breaker..... | 64 |
| Electrical Auxiliary and Accessory Devices..... | 66 |
| Electrical Auxiliary Devices..... | 67 |
| Indication Contacts..... | 69 |
| Wireless Indication Auxiliary..... | 71 |
| Voltage Releases..... | 75 |
| SDx Module..... | 76 |
| PowerTag Energy F160..... | 80 |
| Commissioning and Maintenance..... | 84 |
| Commissioning the Circuit Breaker..... | 85 |
| Maintaining the Circuit Breaker During Operation..... | 91 |
| Responding to a Trip..... | 94 |
| Troubleshooting..... | 96 |
| Appendices..... | 97 |
| Wiring Diagrams..... | 98 |
| Circuit Breakers..... | 98 |
| Index..... | 101 |

Safety Information

Important Information

Read these instructions carefully, and look at the equipment to become familiar with the device before trying to install, operate, service, or maintain it. The following special messages may appear throughout this documentation or on the equipment to warn of potential hazards or to call attention to information that clarifies or simplifies a procedure.



The addition of this symbol to a “Danger” or “Warning” safety label indicates that an electrical hazard exists which will result in personal injury if the instructions are not followed.



This is the safety alert symbol. It is used to alert you to potential personal injury hazards. Obey all safety messages that follow this symbol to avoid possible injury or death.

DANGER

DANGER indicates a hazardous situation which, if not avoided, **will result in** death or serious injury.

WARNING

WARNING indicates a hazardous situation which, if not avoided, **could result in** death or serious injury.

CAUTION

CAUTION indicates a hazardous situation which, if not avoided, **could result in** minor or moderate injury.

NOTICE

NOTICE is used to address practices not related to physical injury.

Please Note

Electrical equipment should be installed, operated, serviced, and maintained only by qualified personnel. No responsibility is assumed by Schneider Electric for any consequences arising out of the use of this material.

A qualified person is one who has skills and knowledge related to the construction and operation of electrical equipment and its installation, and has received safety training to recognize and avoid the hazards involved.

About the Book

Document Scope

This guide provides users, installers, and maintenance personnel with technical information needed to operate ComPacT NSXm circuit breakers in compliance with the IEC/EN, CCC, and EAC standards.

Validity Note

This document applies to ComPacT NSXm circuit breakers, earth-leakage circuit breakers, and switch-disconnectors.

Online Information

The information contained in this guide is likely to be updated at any time. Schneider Electric strongly recommends that you have the most recent and up-to-date version available on www.se.com/ww/en/download.

The technical characteristics of the devices described in this guide also appear online. To access the information online, go to the Schneider Electric home page at www.se.com.

Convention

In this guide, the term *circuit breaker* refers to circuit breakers, earth-leakage circuit breakers, and switch-disconnectors.

Related Documents

| Title of documentation | Reference number |
|---|------------------|
| <i>ComPacT NSXm 3P/4P Circuit Breakers and Switch-disconnectors - Instruction Sheet</i> | NNZ4764707 |
| <i>ComPacT NSXm 3P/4P Earth-Leakage Circuit Breakers - Instruction Sheet</i> | NNZ4764807 |
| <i>MN/MX Voltage Releases - Instruction Sheet</i> | EAV91202 |
| <i>OF/SD Indication Contacts - Instruction Sheet</i> | EAV91204 |
| <i>Wireless Indication Auxiliary - Instruction Sheet</i> | NNZ8881001 |
| <i>SDx Module for Earth-Leakage Circuit Breaker - Instruction Sheet</i> | EAV91206 |
| <i>Connection Accessories - Instruction Sheet</i> | EAV91214 |
| <i>Insulation Accessories - Instruction Sheet</i> | EAV91215 |
| <i>Locking Accessories - Instruction Sheet</i> | NHA56710 |
| <i>Terminal Spreaders - Instruction Sheet</i> | NHA65088 |
| <i>Torque Limiting Breakaway Unit - Instruction Sheet</i> | NHA85013 |
| <i>Interphase Barriers - Instruction Sheet</i> | NHA98087 |
| <i>Open Door Shaft Operator - Instruction Sheet</i> | EAV78496 |
| <i>Direct Rotary Handle - Instruction Sheet</i> | NNZ4765107 |
| <i>Extended Rotary Handle - Instruction Sheet</i> | NNZ4765007 |
| <i>Side Rotary Handle - Instruction Sheet</i> | NNZ4764907 |
| <i>PowerTag F160 3P/3P+N - Instruction Sheet</i> | MFR85580 |

You can download these technical publications and other technical information from our website at www.se.com/ww/en/download.

Presentation

What's in This Part

| | |
|---|----|
| PacT Series Master Range | 8 |
| Feature Overview | 9 |
| Device Overview | 10 |
| Circuit Breakers: Thermal Magnetic (TM-D) Protection | 14 |
| Earth-Leakage Circuit Breakers: Thermal Magnetic and Earth-Leakage Protections | 15 |
| Switch-Disconnectors | 23 |
| Environmental Conditions | 24 |

PacT Series Master Range

Future-proof your installation with Schneider Electric's low-voltage and medium-voltage PacT Series. Built on legendary Schneider Electric innovation, the PacT Series comprises world-class circuit breakers, switches, residual current devices and fuses, for all standard and specific applications. Experience robust performance with PacT Series within the EcoStruxure-ready switchgear, from 16 to 6300 A in low-voltage and up to 40.5 kV in medium-voltage.

Feature Overview

Feature Overview

ComPacT NSXm devices have the following features:

- Circuit breakers rated from 16 to 160 A
- Available constructions: 3 and 4 poles
- Standard compliance to IEC/EN 60947-2 (circuit breakers and earth-leakage circuit breakers) and IEC/EN 60947-3 (switch-disconnectors)
- Breaking capacities: 16, 25, 36, 50, 70 kA at 415 Vac
- Voltage up to 440 Vac for earth-leakage circuit breakers (compliance to IEC/EN 60947-2)
- Voltage up to 690 Vac for circuit breakers (compliance to IEC/EN 60947-2) and switch-disconnectors (compliance to IEC/EN 60947-3)
- Field installable electrical accessories
- Optional terminations
- Optional operating mechanisms
- Optional voltage releases
- Optional auxiliary contacts
- Optional insulation accessories
- Optional locking accessories

Isolation Characteristics

Circuit breakers offer *positive contact indication* and are suitable for isolation in accordance with standards IEC/EN 60947-2 and IEC/EN 60947-3.

The following markings on the device identification label indicate that the devices are capable of isolation:

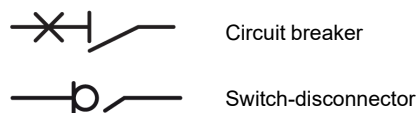

To confirm the isolation capability, the IEC/EN 60947-2 and 3 standards require specific shock withstand tests.

In accordance with installation rules, circuit breakers can be locked in the **O (OFF)** position so that work can be carried out with the power off. Circuit breakers can be locked in the **O (OFF)** position only when they are open.

NOTE: Locking a circuit breaker in the **O (OFF)** position is sufficient to isolate the circuit breaker.

The choice of locking device depends on the type of actuator:

- Locking circuit breakers with a toggle handle, page 41
- Locking circuit breakers with a direct rotary handle, page 48
- Locking circuit breakers with an extended rotary handle, page 57
- Locking circuit breakers with a side rotary handle, page 64

Device Overview

Circuit Breaker and Switch-Disconnecter Description

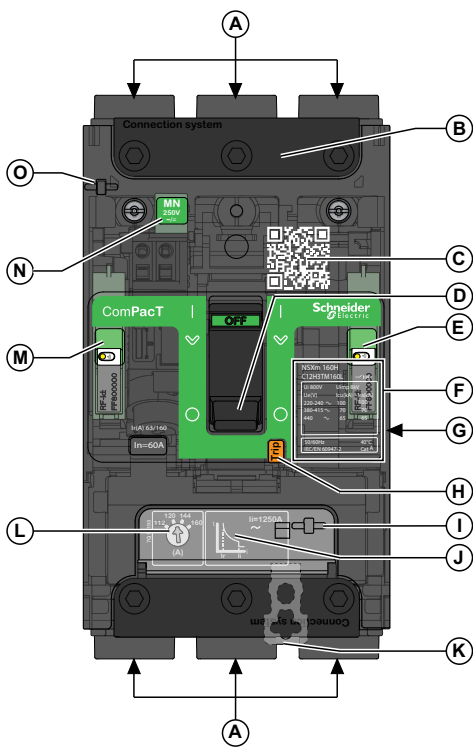

A Power connection (EverLink™ lug, EverLink lug with control wire terminal, compression lug / busbar, mechanical lug)

B Connection system cover

C QR code to product information

D Toggle handle

E Window showing LED on electrical auxiliary device installed on device, for example SD auxiliary contact

F Device identification, certification marks, and IEC/EN interrupting ratings

G Product and accessory data labels

H Push-to-trip button

I Seal for setting cover

J Tripping curve

K DIN rail lock

L Current setting button (for circuit breaker only)

M Window showing LED on electrical auxiliary device installed on device, for example OF auxiliary contact

N MN or MX presence indicator

O Seal for accessory cover

Earth-Leakage Circuit Breaker (ELCB) Description

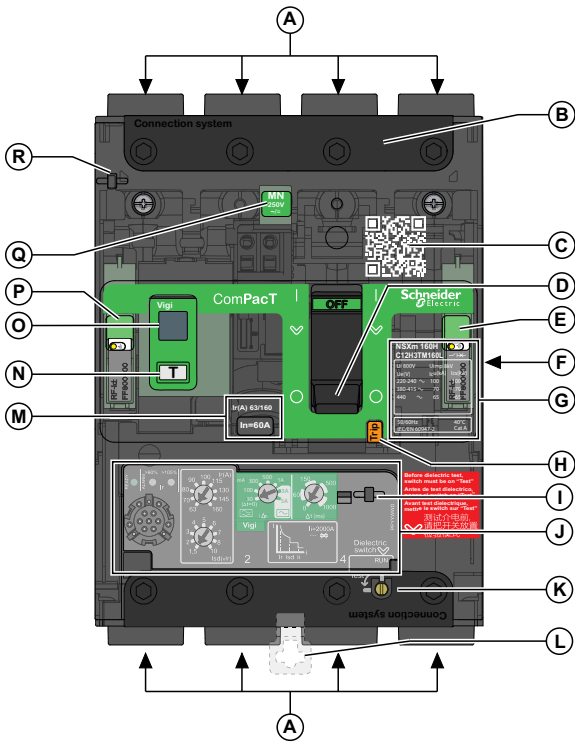

- A** Power connection (EverLink™ lug, EverLink lug with control wire terminal, compression lug / busbar, mechanical lug)
- B** Connection system cover
- C** QR code to product information
- D** Toggle handle
- E** Window showing LED on electrical auxiliary device installed on device, for example SD auxiliary contact
- F** Product and accessory data labels
- G** Device identification, certification marks, and IEC/EN interrupting ratings
- H** Push-to-trip button
- I** Seal for setting cover
- J** Trip unit
- K** Switch to isolate the device during dielectric tests
- L** DIN rail lock
- M** Current rating and protection setting range
- N** Test button of earth-leakage protection
- O** Earth-leakage trip indication
- P** Window showing LED on electrical auxiliary device installed on device, for example OF auxiliary contact
- Q** MN or MX presence indicator
- R** Seal for accessory cover

The trip unit is described in a specific topic, page 16.

QR Code

Scan the QR code to get additional information about the circuit breaker from the Schneider Electric web site. To scan the QR code, use a smartphone that is equipped with a camera and installed with a QR code reader.

Accessories

The following accessories are available for the circuit breaker.

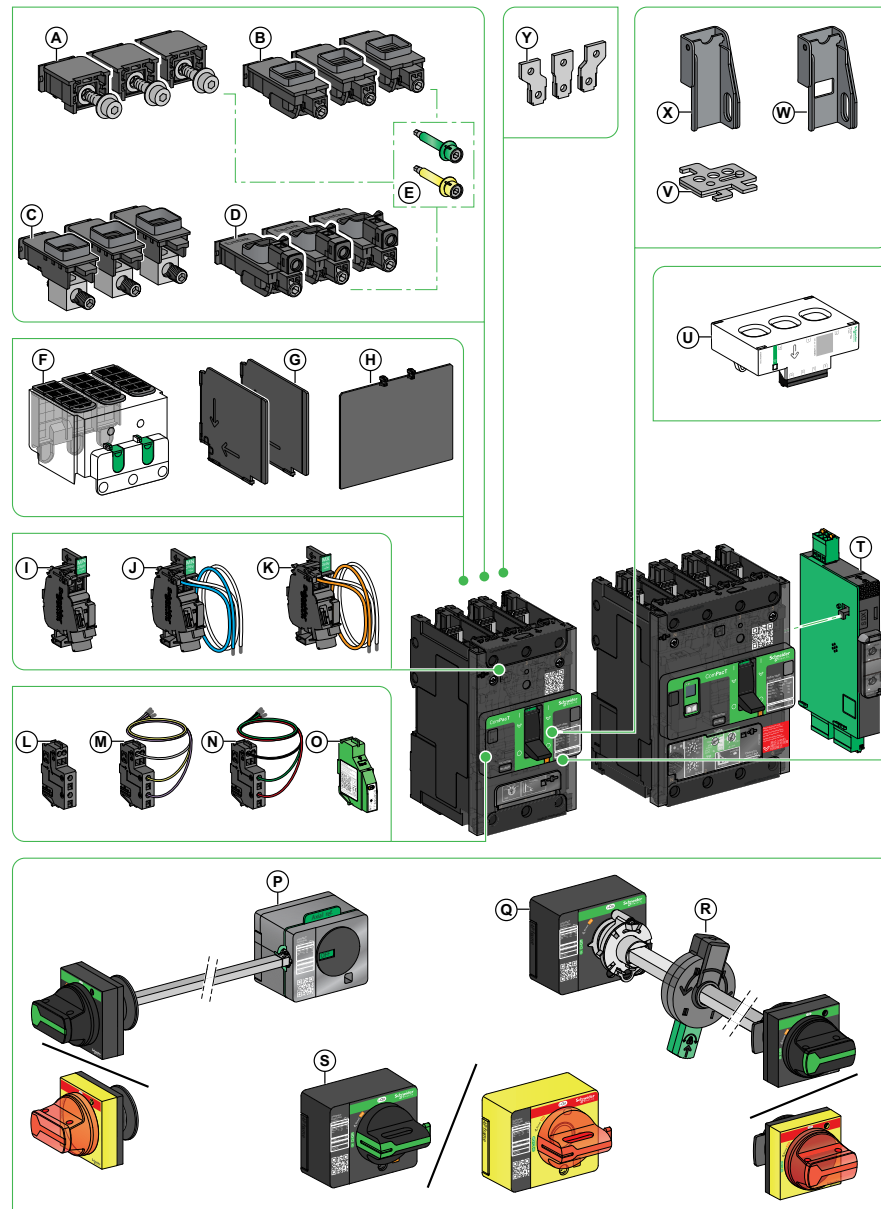

A Compression lug / busbar connector

B EverLink lug without control wire terminal

C Aluminum mechanical lug

D EverLink lug with control wire terminal

E Torque limiting breakaway bits

F Long terminal shield

G Interphase barriers

H Rear insulating screen

I MN or MX voltage release

J MN undervoltage release pre-wired

K MX shunt trip pre-wired

L OF or SD auxiliary contact

M OF auxiliary contact pre-wired

N SD auxiliary contact pre-wired

O Wireless indication auxiliary

P Side rotary handle (right or left)

Q Extended rotary handle

R Open door shaft operator

S Direct mounted rotary handle

T SDx module (for earth-leakage circuit breaker only)

U PowerTag Energy F160

V Removable toggle handle padlocking device (OFF only)

W Fixed toggle handle padlocking device (OFF and ON)

X Fixed toggle handle padlocking device (OFF only)

Y Terminal spreaders

Sealing Accessories

The following sealing accessories can help prevent unauthorized changes to the circuit breaker.

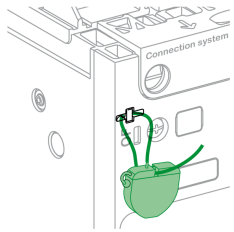
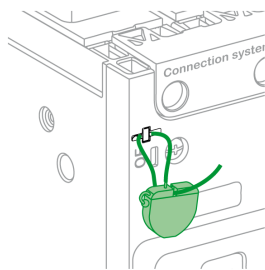
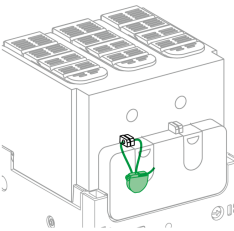
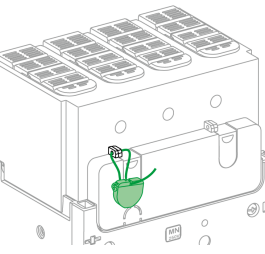
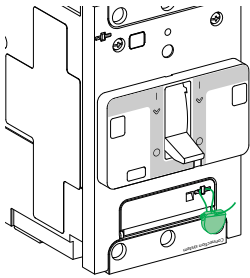
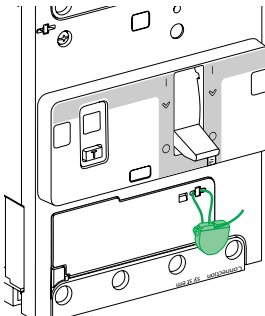
| Seal type | Helps to prevent | Seal image for circuit breaker | Seal image for earth-leakage circuit breaker |
|-------------------------------|---|---|--|
| Seal for cover | <ul style="list-style-type: none"> Removal of the front cover Access to the auxiliaries |  |  |
| Seal for long terminal shield | <ul style="list-style-type: none"> Access to the power connections (helps to prevent direct contact) Dismounting of the circuit breaker |  |  |
| Seal for settings | <ul style="list-style-type: none"> Access to settings |  |  |

Circuit Breakers: Thermal Magnetic (TM-D) Protection

Introduction

Circuit breakers equipped with thermal-magnetic trip units are used for protection of cables on distribution systems supplied by transformers.

Thermal-magnetic trip units provide:

- Thermal protection against overload with an adjustable pickup I_r , and a non-adjustable time-delay.
- Magnetic protection against short circuits, with a fixed pickup I_i .

The following figure shows the tripping curve.

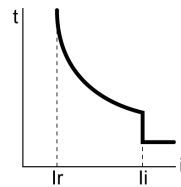

I_r Thermal protection pickup

I_i Instantaneous pickup

Thermal Protection (I_r)

The thermal protection pickup I_r is set by using a setting dial.

Turning the thermal protection adjustment dial (**A**) modifies the tripping curve (**B**), as shown.

The values of I_r are adjustable from 0.7 to 1 x I_n (circuit breaker rating) as shown in the following table:

| Thermal protection | | Circuit breaker rating I_n (A) | | | | | | | | | |
|---|-----------|--|----|----|----|----|----|----|-----|-----|-----|
| | | 16 | 25 | 32 | 40 | 50 | 63 | 80 | 100 | 125 | 160 |
| Pickup trip between 1.05 and 1.30 x I_r | I_r (A) | Adjustable in amps from 0.7 to 1 x I_n | | | | | | | | | |
| Time delay (s) | t_r (s) | Non-adjustable | | | | | | | | | |

Magnetic Protection (I_i)

The instantaneous pickup value I_i cannot be adjusted. Its value for each circuit breaker rating is shown in the following table:

| Magnetic protection | | Circuit breaker rating I_n (A) | | | | | | | | | |
|---------------------|-----------|----------------------------------|-----|-----|-----|-----|-----|------|------|------|------|
| | | 16 | 25 | 32 | 40 | 50 | 63 | 80 | 100 | 125 | 160 |
| Pickup $\pm 20\%$ | I_i (A) | 500 | 600 | 600 | 600 | 600 | 800 | 1000 | 1250 | 1250 | 1250 |

The time delay for magnetic protection cannot be adjusted:

- Non-tripping time: 10 ms
- Maximum breaking time: 200 ms for $I > 1.5 I_i$

Earth-Leakage Circuit Breakers: Thermal Magnetic and Earth-Leakage Protections

Introduction

Earth-leakage circuit breakers provide the following protection functions:

- Long time protection against overload with an adjustable pickup I_r , and a non-adjustable time delay t_r .
- Short-time protection against short-circuits, with an adjustable pickup I_{sd} , and a non-adjustable time delay t_{sd} .
- Instantaneous protection against short-circuits, with a fixed pickup I_i .
- Neutral protection against overload and short-circuits.
- Earth-leakage protection, against low intensity residual current, with an adjustable pickup $I_{\Delta n}$, and an adjustable time delay Δt .

The following figures show the tripping curves:

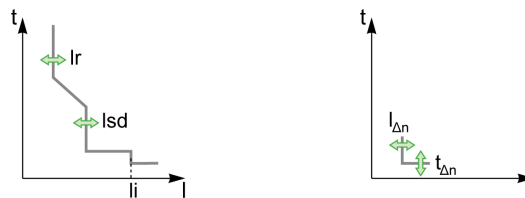

Trip Unit Description

The adjustment dials and indications are on the front face of the trip unit or are accessible after opening protective covers.

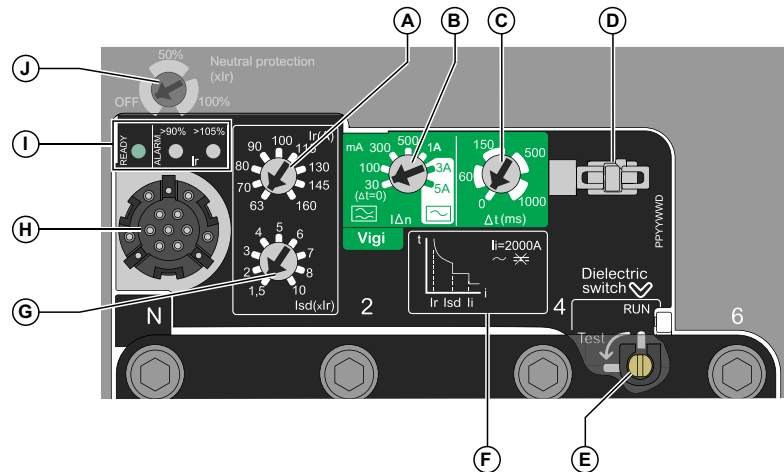

- A** Long-time protection pickup setting (I_r)
- B** Earth-leakage protection pickup setting ($I_{\Delta n}$)
- C** Earth-leakage protection time delay setting (Δt)
- D** Seal for setting cover
- E** Switch to isolate the device during dielectric tests
- F** Tripping curve and instantaneous pickup (I_i)
- G** Short-time protection pickup setting (I_{sd})
- H** Test port
- I** Indication LEDs
- J** Neutral protection setting (4P device only)

Indication LEDs

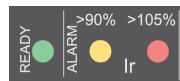

Indication LEDs on the front of the trip unit indicate its operational state.

| Indication LED | Description |
|-------------------------------|--|
| Green READY LED | Flashes slowly when the circuit breaker is ready to trip in the event of an overload or short-circuit. |
| Orange overload pre-alarm LED | Shows a steady light when the load exceeds 90% of the I_r setting. |
| Red overload alarm LED | Shows a steady light when the load exceeds 105% of the I_r setting. |

Setting the Long Time Protection

The long time protection pickup I_r is set by using a multi-position dial.

The long time protection tripping range is 1.05–1.20 I_r according to standard IEC/EN 60947-2.

| Rating I_n (A) | Preset values of I_r (A) depending on the rating I_n and the dial position | | | | | | | | |
|------------------|--|----|----|----|-----|-----|-----|-----|-----|
| 25 | 10 | 11 | 12 | 14 | 16 | 18 | 20 | 22 | 25 |
| 50 | 20 | 22 | 25 | 28 | 32 | 36 | 40 | 45 | 50 |
| 100 | 40 | 45 | 50 | 56 | 63 | 70 | 80 | 90 | 100 |
| 160 | 63 | 70 | 80 | 90 | 100 | 115 | 130 | 145 | 160 |

The time delay t_r for long time protection cannot be adjusted.

The following table shows the value of the time delay t_r for long time protection (in seconds) according to the overload current (in multiples of I_r).

| at 1.5 I_r | at 6 I_r | at 7.2 I_r |
|---------------|-------------|--------------|
| $t_r = 200$ s | $t_r = 8$ s | $t_r = 5$ s |

The accuracy range is -20%/+0%.

Thermal Memory

The trip unit incorporates the thermal memory function which ensures that the conductors are cooled even after tripping. Cooling lasts for 20 minutes before or after tripping.

Setting the Short-Time Protection

The short-time protection pickup I_{sd} is set by using a multi-position dial.

The setting value is expressed in multiples of I_r .

| Step | Action |
|------|---|
| 1 | Set the long time protection first: the setting pickup is I_r . |
| 2 | Turn the I_{sd} adjustment dial to the value required. The I_{sd} value is adjustable from 1.5 I_r to 10 I_r . |
| 3 | $I_{sd} = I_{sd} \text{ setting} \times I_r$. |

The accuracy range is +/-15%.

The time delay t_{sd} for short-time protection cannot be adjusted:

- Non-tripping time: 20 ms
- Maximum breaking time: 80 ms

Example of Setting the Short-Time Protection

Setting the short-time protection pickup I_{sd} to 500 A on an earth-leakage circuit breaker rated (I_n) 160 A (see diagram below).

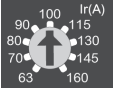
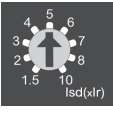
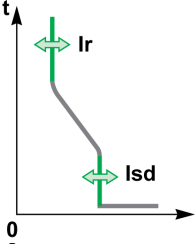
| Step | Action | |
|------|---|---|
| 1 | The setting pickup I_r for long time protection is equal to 100 A. |  |
| 2 | Setting calculation: $I_{sd}/I_r = 500/100 = 5$ Position the I_{sd} adjustment dial on setting 5. |  |
| 3 | I_{sd} is set to 5 x 100 A (= 500 A). |  |

Setting the Instantaneous Protection

The pickup I_i and time delay for instantaneous protection cannot be adjusted.

The following table shows the value of the pickup I_i (in amperes) and time delay (in milliseconds) for instantaneous protection according to the rating I_n :

| Rating I_n (A) | 25 | 50 | 100 | 160 |
|------------------------|-----|-----|------|------|
| Pickup I_i (A) | 375 | 750 | 1500 | 2000 |
| Non-tripping time (ms) | 10 | 10 | 10 | 5 |

The accuracy range of pickup is +/-15%.

The maximum breaking time is 50 ms for $I > 1.5 I_i$

Setting the Neutral Protection (4P Only)

The neutral selection dial gives a choice of two or three values for the neutral long time and short-time protection pickups.

NOTE: To access the neutral selection dial, open the ELCB accessory cover by unscrewing the two front screws.

The following table shows the values of the pickup for neutral long time protection (in multiples of I_r) and neutral short-time protection (in multiples of I_{sd}) according to the dial position:

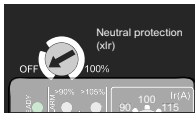
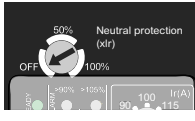
| Rating I_n (A) | Dial | Setting | Long-time setting value | Short-time setting value |
|------------------|---|-------------------|-------------------------|--------------------------|
| 25–50 |  | OFF (4P 3D) | – | – |
| | | 100% (4P 4D) | I_r | I_{sd} |
| 100–160 |  | OFF (4P 3D) | – | – |
| | | 50% (4P 3D + N/2) | $I_r/2$ | $I_{sd}/2$ |
| | | 100% (4P 4D) | I_r | I_{sd} |

The time delay for the neutral long time protection and short-time protection is the same as that for the phases.

Operating Principle of Earth-Leakage Protection

Earth-leakage protection is definite time. The earth-leakage protection threshold $I_{\Delta n}$ sets the level of earth-leakage at which the circuit breaker trips when reaching the earth-leakage protection time delay Δt .

Setting the Earth-Leakage Protection

The earth-leakage protection $I_{\Delta n}$ is set by using one multi-position dial.

The following table shows the value of the pickup $I_{\Delta n}$ for earth-leakage protection according to the type defined in IEC/EN 60947-2, Annex B standard:

| Earth-leakage type | Pickup $I_{\Delta n}$ | | | | | | |
|--------------------|-----------------------|--------|--------|--------|-----|-----|-----|
| | 30 mA | 100 mA | 300 mA | 500 mA | 1 A | – | – |
| A ⁽¹⁾ | 30 mA | 100 mA | 300 mA | 500 mA | 1 A | – | – |
| AC ⁽²⁾ | 30 mA | 100 mA | 300 mA | 500 mA | 1 A | 3 A | 5 A |

(1) Residual current circuit breakers which provide additional protection to AC type in that they are sensitive to AC currents and pulsating DC currents. Tripping is ensured for sinusoidal, alternating residual currents as well as for pulsed DC residual currents, whether suddenly applied or slowly arising.

(2) Residual current circuit breakers sensitive to AC currents and suitable for most domestic and commercial applications. Tripping is ensured for sinusoidal, alternating currents, whether suddenly applied or slowly arising.

Setting the Earth-Leakage Protection Time Delay

The time delay of the earth-leakage protection is set by using one multi-position dial.

When $I_{\Delta n}$ is set to **30 mA**, the time delay has a fixed value of $\Delta t = 0$ s (instantaneous tripping).

When $I\Delta n$ is set above **30 mA**, the time delay Δt can be adjusted to the following values:

- 0 ms
- 60 ms
- 150 ms
- 500 ms
- 1 second

Testing the Earth-Leakage Protection



The earth-leakage protection must be tested regularly by using the test button (T). Pressing the test button simulates a real leakage current passing through the toroid, and the device trips.

| |
|---|
| ⚠ CAUTION |
| HAZARD OF NUISANCE TRIPPING |
| Circuit breaker tests must only be done by qualified electrical personnel. |
| Failure to follow these instructions can result in injury or equipment damage. |

When testing the earth-leakage protection function, take precautions against:

- Disrupting operations
- Activating inappropriate alarms
- Triggering unwanted actions

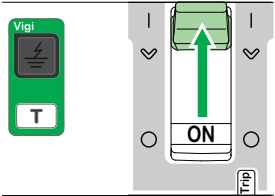
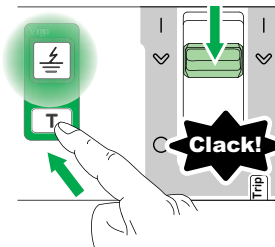
Follow these steps to test the earth-leakage protection of an earth-leakage circuit breaker (for example, with a toggle handle).

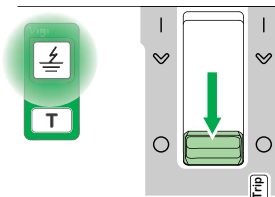
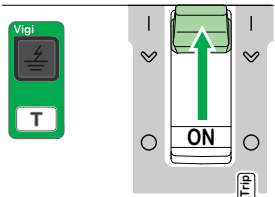
| Step | Action | |
|------|--|---|
| 1 | Energize the earth-leakage circuit breaker: $200 \text{ Vac} \leq \text{VL-L} \leq 440 \text{ Vac}$. | – |
| 2 | Push the toggle handle from the O (OFF) position to the I (ON) position. The circuit breaker is closed. |  |
| 3 | Press the test button T : the earth-leakage circuit breaker trips and the earth-leakage trip indication lights up. NOTE: If the earth-leakage circuit breaker does not trip: 1. Check that the earth-leakage circuit breaker is energized (see step 1). 2. If the earth-leakage circuit breaker is correctly energized and has not tripped, replace it. |  |
| 4 | Push the toggle handle from the  (Trip) position to the O (OFF) position. The earth-leakage trip indication: • stays lit if the earth-leakage circuit breaker is energized upstream. • turns off if the earth-leakage circuit breaker is energized downstream. |  |
| 5 | Push the toggle handle from the O (OFF) position to the I (ON) position. The earth-leakage trip indication turns off (if the earth-leakage circuit breaker is energized upstream). The circuit breaker is closed. |  |

NOTE: Test the earth-leakage protection at regular intervals. Schneider Electric recommends that the test is carried out:

- Every three months in case of absence of local regulation.
- Once a month for devices in corrosive, dusty, or harsh environment.

Switch-Disconnectors

Introduction

A switch-disconnector is a control device that can be used to open and close a circuit under normal operating conditions. The switch-disconnector can make or break its rated current. For an overload or a short-circuit, it must be protected by an upstream device, in compliance with installation standards.

Switch-Disconnector Utilization Category

Depending on the rated operational current and the mechanical durability (A for frequent operation or B for infrequent operation), standard IEC/EN 60947-3 defines the utilization categories as shown in the following table. ComPacT NSXm NA switch-disconnectors comply with utilization categories AC-21A or AC-22A up to 160 A and AC-23A up to 100 A.

| Utilization categories | | |
|------------------------|--------------------|--|
| Infrequent operation | Frequent operation | Characteristics |
| AC-21B | AC-21A | Switching of resistive loads including moderate overloads ($\cos \varphi = 0.95$) |
| AC-22B | AC-22A | Switching of mixed resistive and inductive loads, including moderate overloads ($\cos \varphi = 0.65$) |
| AC-23B | AC-23A | Switching of motor loads or other highly inductive loads ($\cos \varphi = 0.45$ or 0.35) |

Environmental Conditions

Temperature

The following temperatures are relevant for circuit breakers:

- **Ambient temperature:** the temperature of the air immediately surrounding the circuit breaker. If the temperature inside the enclosure is above 40 °C (104 °F), devices must be derated.
- **Operating temperature range:**
 - Circuit breaker: -25 °C to +70 °C (-13 °F to +158 °F).
NOTE: Commissioning is possible down to -35 °C (-31 °F).
 - Earth-leakage circuit breaker: -25 °C to +70 °C (-13 °F to +158 °F).
NOTE: The earth-leakage trip indication may not work below -15 °C (5 °F).
- **Storage temperature range (in original packing):** -50 °C to +85 °C (-58 °F to +185 °F).

Temperature Derating for Earth-Leakage Circuit Breaker

Above the reference temperature of 40 °C (104 °F), the ampere ratings for the earth-leakage circuit breaker are given in the following derating table:

| Circuit breaker rating In (A) | Temperature | | | | | | |
|-------------------------------|----------------|----------------|----------------|----------------|----------------|----------------|----------------|
| | 40 °C (104 °F) | 45 °C (113 °F) | 50 °C (122 °F) | 55 °C (131 °F) | 60 °C (140 °F) | 65 °C (149 °F) | 70 °C (158 °F) |
| 25 | 25 | 25 | 25 | 25 | 25 | 25 | 25 |
| 50 | 50 | 50 | 50 | 50 | 50 | 50 | 50 |
| 100 | 100 | 100 | 100 | 100 | 100 | 100 | 100 |
| 160 | 160 | 155 | 150 | 145 | 140 | 135 | 130 |

Temperature Derating for Thermal-Magnetic (TM-D) Circuit Breaker

Above the reference temperature of 40 °C (104 °F), the ampere ratings for the circuit breaker are given in the following derating table:

| Circuit breaker rating In (A) | Temperature | | | | | | |
|-------------------------------|----------------|----------------|----------------|----------------|----------------|----------------|----------------|
| | 40 °C (104 °F) | 45 °C (113 °F) | 50 °C (122 °F) | 55 °C (131 °F) | 60 °C (140 °F) | 65 °C (149 °F) | 70 °C (158 °F) |
| 16 | 16 | 16 | 15 | 15 | 14 | 14 | 13 |
| 25 | 25 | 24 | 24 | 23 | 23 | 22 | 21 |
| 32 | 32 | 31 | 30 | 30 | 29 | 28 | 27 |
| 40 | 40 | 39 | 38 | 37 | 36 | 34 | 33 |
| 50 | 50 | 49 | 48 | 46 | 45 | 44 | 42 |
| 63 | 63 | 61 | 60 | 58 | 56 | 54 | 53 |
| 80 | 80 | 77 | 73 | 70 | 67 | 64 | 60 |
| 100 | 100 | 96 | 94 | 90 | 87 | 83 | 80 |
| 125 | 125 | 120 | 117 | 113 | 109 | 104 | 100 |
| 160 | 160 | 155 | 149 | 144 | 139 | 133 | 126 |

Correction Factor for Thermal-Magnetic (TM-D) Circuit Breaker Tripping Time

The overload protection is calibrated at 40 °C (104 °F) in the lab. This means that when the ambient temperature is below or above 40 °C (104 °F), the Ir protection pickup is slightly different.

The following table gives the correction factor that applies to tripping time depending on ambient temperature:

| Rating In (A) | Temperature | | | | | | | | | | | | | |
|---------------|---------------|---------------|---------------|---------------|---------------|---------------|----------------|----------------|----------------|----------------|----------------|----------------|----------------|--|
| | 10 °C (50 °F) | 15 °C (59 °F) | 20 °C (68 °F) | 25 °C (77 °F) | 30 °C (86 °F) | 35 °C (95 °F) | 40 °C (104 °F) | 45 °C (113 °F) | 50 °C (122 °F) | 55 °C (131 °F) | 60 °C (140 °F) | 65 °C (149 °F) | 70 °C (158 °F) | |
| 16 | 1.16 | 1.13 | 1.11 | 1.08 | 1.05 | 1.03 | 1.00 | 0.97 | 0.94 | 0.91 | 0.88 | 0.85 | 0.81 | |
| 25 | 1.13 | 1.11 | 1.09 | 1.07 | 1.05 | 1.02 | 1.00 | 0.98 | 0.95 | 0.93 | 0.90 | 0.88 | 0.85 | |
| 32 | 1.14 | 1.11 | 1.09 | 1.07 | 1.05 | 1.02 | 1.00 | 0.98 | 0.95 | 0.93 | 0.90 | 0.87 | 0.84 | |
| 40 | 1.15 | 1.12 | 1.10 | 1.08 | 1.05 | 1.03 | 1.00 | 0.97 | 0.95 | 0.92 | 0.89 | 0.86 | 0.83 | |
| 50 | 1.13 | 1.11 | 1.09 | 1.07 | 1.05 | 1.02 | 1.00 | 0.98 | 0.95 | 0.93 | 0.90 | 0.87 | 0.85 | |
| 63 | 1.14 | 1.12 | 1.10 | 1.07 | 1.05 | 1.02 | 1.00 | 0.97 | 0.95 | 0.92 | 0.89 | 0.86 | 0.83 | |
| 80 | 1.21 | 1.18 | 1.14 | 1.11 | 1.07 | 1.04 | 1.00 | 0.96 | 0.92 | 0.88 | 0.83 | 0.80 | 0.75 | |
| 100 | 1.18 | 1.16 | 1.12 | 1.10 | 1.06 | 1.04 | 1.00 | 0.96 | 0.94 | 0.90 | 0.87 | 0.83 | 0.80 | |
| 125 | 1.17 | 1.14 | 1.11 | 1.08 | 1.06 | 1.03 | 1.00 | 0.96 | 0.93 | 0.90 | 0.87 | 0.84 | 0.80 | |
| 160 | 1.17 | 1.15 | 1.12 | 1.09 | 1.06 | 1.03 | 1.00 | 0.97 | 0.93 | 0.90 | 0.87 | 0.83 | 0.79 | |

Extreme Atmospheric Conditions

Circuit breakers and earth-leakage circuit breakers are designed to operate in industrial atmospheres as defined in standard IEC/EN 60947-2 and IEC/EN 60664-1 for the highest level of pollution (level 3).

Switch-disconnectors are designed to operate in industrial atmospheres as defined in standard IEC/EN 60947-3 and IEC/EN 60664-1 for the highest level of pollution (level 3).

Circuit breakers are tested for extreme storage conditions and are compliant with the following standards:

| Standard | Title |
|-------------------|--|
| IEC/EN 60068-2-2 | Dry heat, severity level +85 °C (+185 °F) |
| IEC/EN 60068-2-1 | Dry cold, severity level –50 °C (–58 °F) (circuit breaker only) |
| IEC/EN 60068-2-30 | Damp heat: <ul style="list-style-type: none"> • Temperature +55 °C (+131 °F) • Relative humidity 95% |
| IEC/EN 60068-2-52 | Salt-mist, severity 2 |

To maximize lifetime, install circuit breakers in properly ventilated equipment with minimal dust.

Vibration

Circuit breakers are designed to withstand vibration. They meet the IEC/EN 60068-2-6 standard for vibration:

- 2 Hz to 13.2 Hz with an amplitude of +/- 1 mm (+/- 0.04 in.)
- 13.2 Hz to 100 Hz at a constant acceleration of +/- 0.7 g

Conformity tests are carried out in accordance with the IEC/EN 60068-2-6 standard, at the levels of severity required by the merchant shipping regulatory bodies (mainly IACS, Veritas, and Lloyds).

Excessive vibration can cause tripping, breaks in connections, or damage to mechanical parts.

Electromagnetic Disturbance

Circuit breakers resist electromagnetic disturbance. They comply with the requirements of the electromagnetic compatibility (EMC) standard IEC/EN 60947-2.

Altitude

Circuit breakers are designed to operate within specification at altitudes up to 2,000 m (6,600 ft.). Above 2,000 m (6,600 ft.), the following derating is required:

| Characteristic | | Altitude (m/ft) | | | |
|---|------------------|-----------------------|-----------------------|------------------------|------------------------|
| | | 2,000 m (6,600 ft) | 3,000 m (9,800 ft) | 4,000 m (13,000 ft) | 5,000 m (16,500 ft) |
| Impulse withstand voltage | U _{imp} | 8 kV | 7.1 kV | 6.4 kV | 5.6 kV |
| Insulation voltage for circuit breaker | U _i | 800 V | 710 V | 635 V | 560 V |
| Insulation voltage for earth-leakage circuit breaker | U _i | 500 V | 445 V | 400 V | 350 V |
| Maximum operational voltage for circuit breaker | U _e | 690 V | 690 V | 635 V | 560 V |
| Maximum operational voltage for earth-leakage circuit breaker | U _e | 440 V | 440 V | 400 V | 350 V |
| Average current capacity (A) at 40 °C (104 °F) | In x | 1 | 0.98 | 0.96 | 0.94 |

Insulation Requirements and Accessories

What's in This Part

| | |
|--|----|
| Insulation Accessories | 28 |
| Clearance Requirements for ComPacT NSXm Circuit Breakers | 30 |

Insulation Accessories

Overview of Insulation Accessories

The following insulation accessories can be used with the range of ComPacT NSXm circuit breakers. For more information, see LVPED217032EN *ComPacT NSX & NSXm Catalogue*.

| Insulation accessory | All power connectors | |
|------------------------|----------------------|----|
| | 3P | 4P |
| Long terminal shield | ✓ | ✓ |
| Interphase barriers | ✓ | ✓ |
| Rear insulation screen | ✓ | ✓ |

Presentation of Insulation Accessories

The following insulation accessories can be installed on-site.

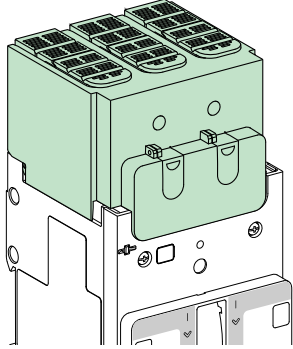
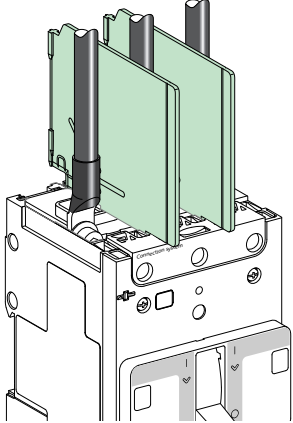
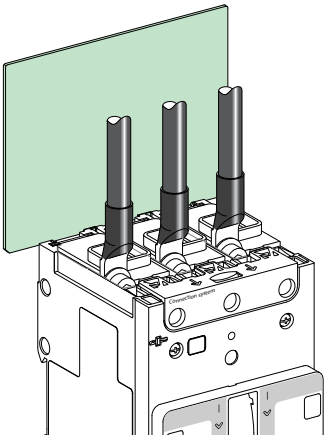
| Insulation accessory | Benefit | Accessory image |
|------------------------------|---|---|
| Long terminal shield | IP40 protection |  |
| Flexible interphase barriers | Improve insulation between power connections |  |
| Rear insulation screen | Improve insulation between backplate and power connections, especially with spreaders |  |

Clearance Requirements for ComPacT NSXm Circuit Breakers

Introduction

When installing ComPacT NSXm circuit breakers in equipment, minimum distances (safety clearance) must be maintained between the device and panels, bars, or any metal installed nearby.

Minimum distances depend on the ultimate breaking capacity, and are defined by tests carried out in accordance with the IEC/EN 60947-2 standard.

If IEC/EN installation conformity is not checked by type tests, you must also:

- Use insulated bars for circuit breaker connections.
- Block off the busbars by using rear insulation screens.

Equipment Installation Requirements

|  DANGER |
|--|
| HAZARD OF ELECTRIC SHOCK, EXPLOSION, OR ARC FLASH |
| <ul style="list-style-type: none">• Apply appropriate personal protective equipment (PPE) and follow safe electrical work practices. See NFPA 70E, CSA Z462, NOM-029-STPS, or local equivalent.• This equipment must only be installed and serviced by qualified electrical personnel.• Turn off all power supplying this equipment before working on or inside equipment.• Always use a properly rated voltage sensing device to confirm that power is off.• Replace all devices, doors, and covers before turning on power to this equipment.• Beware of potential hazards, and carefully inspect the work area for tools and objects that may have been left inside the equipment. |
| Failure to follow these instructions will result in death or serious injury. |

Follow these guidelines when installing circuit breakers in equipment:

- Respect minimum distances.
- Perform dielectric strength tests, thermal calculations, and temperature rise tests as required by the configuration of the installation.
- Respect the limits defined in the derating tables, depending on the ambient temperature (ratings are based on IEC/EN 60947-2 standard).

|  DANGER |
|---|
| HAZARD OF ELECTRIC SHOCK, EXPLOSION, OR ARC FLASH |
| Install circuit breaker so minimum clearance distance to grounded metal is maintained. |
| Failure to follow these instructions will result in death or serious injury. |

Minimum Distances for Side-by-Side Installation

There is no minimum distance required between circuit breakers installed side-by-side.

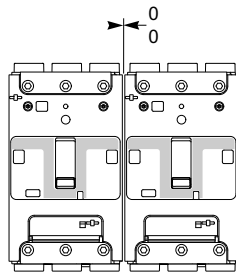

Minimum Clearance Without Insulation Accessories

The minimum clearance distances required around circuit breakers without insulation accessories are shown below.

| 3P/4P | Clearance (Operating voltage ≤690 V) |
|---|---|
| <p>The diagram shows a 3P/4P circuit breaker with dimensions A1, A2, and B. A1 is the vertical clearance above the breaker, A2 is the vertical clearance below the breaker, and B is the horizontal clearance on both sides of the breaker.</p> | <p>With painted sheet metal:</p> <ul style="list-style-type: none"> • A1: 30 mm (1.18 in.) • A2: 5 mm (0.19 in.) • B: 0 mm (0 in.) <p>With bare sheet metal:</p> <ul style="list-style-type: none"> • A1: 40 mm (1.57 in.) • A2: 5 mm (0.19 in.) • B: 5 mm (0.19 in.) |

Minimum Clearance with Interphase Barriers

The minimum clearance distances required around circuit breakers equipped with interphase barriers are shown below.

| 3P/4P | Clearance (Operating voltage ≤690 V) |
|--|---|
| <p>The diagram shows a 3P/4P circuit breaker with interphase barriers. Dimensions A1, A2, and B are shown. A1 is the vertical clearance above the breaker, A2 is the vertical clearance below the breaker, and B is the horizontal clearance on both sides of the breaker.</p> | <p>With painted sheet metal:</p> <ul style="list-style-type: none"> • A1: 0 mm (0 in.) • A2: 0 mm (0 in.) • B: 0 mm (0 in.) <p>With bare sheet metal:</p> <ul style="list-style-type: none"> • A1: 0 mm (0 in.) • A2: 0 mm (0 in.) • B: 5 mm (0.19 in.) |

Minimum Clearance with Long Terminal Shields

The minimum clearance distances required around circuit breakers equipped with long terminal shields are shown below.

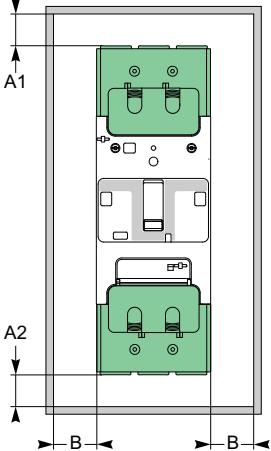
| 3P/4P | Clearance (Operating voltage ≤690 V) |
|---|---|
|  | <p>With painted sheet metal:</p> <ul style="list-style-type: none"> • A1: 0 mm (0 in.) • A2: 0 mm (0 in.) • B: 0 mm (0 in.) <p>With bare sheet metal:</p> <ul style="list-style-type: none"> • A1: 0 mm (0 in.) • A2: 0 mm (0 in.) • B: 5 mm (0.19 in.) |

Minimum Clearance to Bare Busbars

The minimum clearance distances required around circuit breakers that use busbars are shown below.

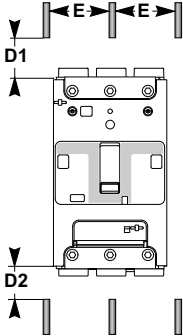
| 3P/4P | Spacing | Clearance ⁽¹⁾ (Operating voltage ≤690 V) |
|--|---|--|
|  | <p>$E \leq 60 \text{ mm (2.36 in.)}$</p> | <ul style="list-style-type: none"> • D1: 200 mm (7.87 in.) • D2: 100 mm (3.94 in.) |
| | <p>$E > 60 \text{ mm (2.36 in.)}$</p> | <ul style="list-style-type: none"> • D1: 120 mm (4.72 in.) • D2: 60 mm (2.36 in.) |
| <p>(1) These clearances can be reduced for special installations if they are validated with appropriate tests.</p> | | |

Minimum Clearance Between Backplate and Uninsulated Power Connections

For all types of ComPacT NSXm circuit breakers that use uninsulated power connections (for example, busbars, spreaders, or uninsulated crimped lugs), the minimum clearance distance with the enclosure backplate is shown below.

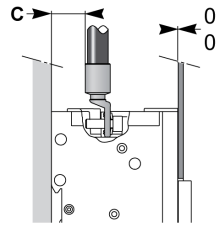

A rear insulation screen or long terminal shield is required if the distance C is less than 8 mm (0.32 in).

Operation

What's in This Part

| | |
|--|----|
| Operating a Circuit Breaker with Toggle Handle | 35 |
| Operating a Circuit Breaker with Direct Rotary Handle..... | 42 |
| Operating a Circuit Breaker with Front Extended Rotary Handle..... | 51 |
| Operating a Circuit Breaker with Side Rotary Handle..... | 60 |

Operating a Circuit Breaker with Toggle Handle

What's in This Chapter

| | |
|--|----|
| Description | 36 |
| Opening, Closing, Resetting, and Testing the Circuit Breaker | 38 |
| Locking the Circuit Breaker | 41 |

Description

Front Face

The following figure shows the controls and indicators for a 3-pole circuit breaker with a toggle handle. The location of controls and indicators may differ for the other types of circuit breakers. Information about the other parts of the front face is available in the general description, page 10.

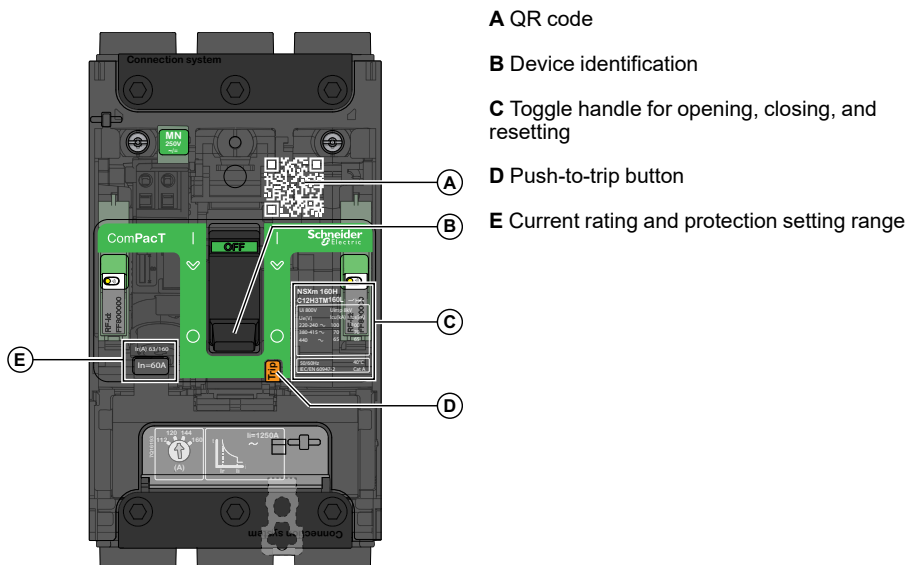

Device Identification

The following figure shows an example of the device identification for a circuit breaker with a toggle handle. Your circuit breaker may have different values.

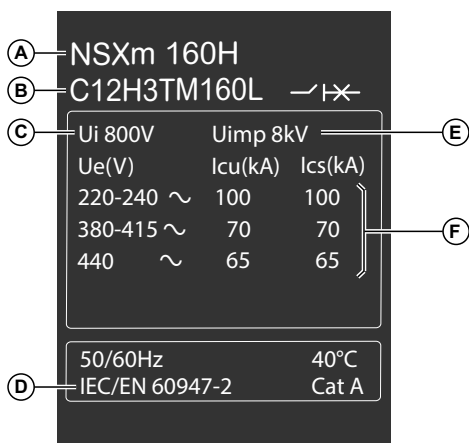

A Circuit breaker type:

- Range name (ComPacT NSXm)
- Circuit breaker rating In (160)
- Performance level (H)

B Commercial reference

C **Ui**: rated insulation voltage

D IEC/EN reference standard

E **Uimp** rated impulse withstand voltage

F IEC/EN interrupting ratings, according to operating voltage Ue:

Icu: Ultimate breaking capacity

Ics: Service breaking capacity

QR Code

Scan the QR code to get additional information about the circuit breaker from the Schneider Electric website. To scan the QR code, use a smartphone that is equipped with a camera and installed with a QR code reader.

Opening, Closing, Resetting, and Testing the Circuit Breaker

Opening and Closing with the Toggle Handle

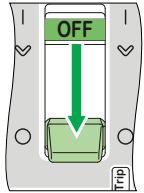
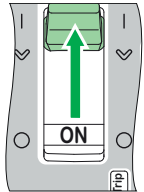
| Task | Action | |
|---------------------------|--|--|
| Open the circuit breaker | Push the toggle handle from the I (ON) position to the O (OFF) position. |  <p>The diagram shows a vertical toggle handle mechanism. At the top, the word 'OFF' is printed in green. Below it, a green arrow points downwards, indicating the direction of movement. At the bottom, the word 'ON' is printed in black. The handle is currently in the 'ON' position, and the arrow indicates it should be pushed down to the 'OFF' position.</p> |
| Close the circuit breaker | Push the toggle handle from the O (OFF) position to the I (ON) position |  <p>The diagram shows a vertical toggle handle mechanism. At the top, the word 'OFF' is printed in black. Below it, a green arrow points upwards, indicating the direction of movement. At the bottom, the word 'ON' is printed in green. The handle is currently in the 'OFF' position, and the arrow indicates it should be pushed up to the 'ON' position.</p> |

Resetting with the Toggle Handle After a Trip

When the circuit breaker trips, the toggle handle moves from the **I (ON)** position to the **∩** (Trip) position.

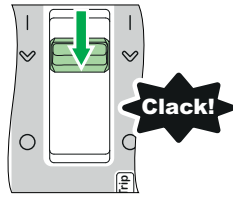

⚠ WARNING

HAZARD OF CLOSING ON ELECTRICAL FAULT

Do not close the circuit breaker again without first inspecting and, if necessary, repairing the downstream electrical equipment.

Failure to follow these instructions can result in death, serious injury, or equipment damage.

The fact that a circuit breaker has tripped does not fix the cause of the fault detected on the downstream electrical equipment.

Follow these steps to reset the circuit breaker after a trip caused by an electrical fault.

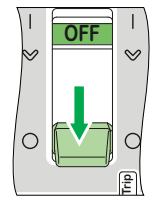
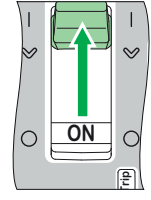
| Step | Action | | Position |
|------|--|---|----------------|
| 1 | Push the toggle handle from the ∩ (Trip) position to the O (OFF) position. The circuit breaker is open. |  | O (OFF) |
| 2 | Take precautions to protect yourself, page 94. | — | O (OFF) |
| 3 | Look for the cause of the detected fault, page 94. | — | O (OFF) |
| 4 | Clean and test the downstream equipment and the circuit breaker, page 95. | — | O (OFF) |
| 5 | Push the toggle handle from the O (OFF) position to the I (ON) position. The circuit breaker is closed. |  | I (ON) |

Testing the Trip Mechanism

⚠ CAUTION

HAZARD OF NUISANCE TRIPPING

Circuit breaker tests must only be done by qualified electrical personnel.





Failure to follow these instructions can result in injury or equipment damage.

When testing the trip mechanism, take precautions against:

- Disrupting operations
- Activating inappropriate alarms
- Triggering unwanted actions

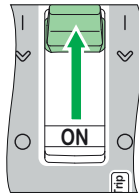
For example, tripping the circuit breaker with the push-to-trip button can lead to inappropriate fault indications or corrective actions (such as switching to an alternate power source).

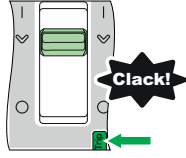
Follow these steps to test the trip mechanism.

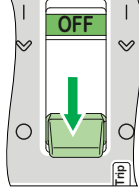
| Step | Action | | Position |
|------|---|---|--|
| 1 | <p>Push the toggle handle from the O (OFF) position to the I (ON) position.</p> <p>The circuit breaker is closed.</p> |  | I (ON) |
| 2 | <p>Press the push-to-trip button.</p> <p>The handle moves from the I (ON) position to the  (Trip) position. The circuit breaker is tripped.</p> |  |  (Trip) |
| 3 | <p>Push the toggle handle from the  (Trip) position to the O (OFF) position.</p> <p>The circuit breaker is reset.</p> |  | O (OFF) |

Locking the Circuit Breaker

Locking Options for the Toggle Handle

⚠️ ⚠️ DANGER

HAZARD OF ELECTRIC SHOCK, EXPLOSION, OR ARC FLASH

When the circuit breaker handle is locked in the **(O) OFF** position, always use a properly rated voltage sensing device to confirm that power is off before working on equipment.

Failure to follow these instructions will result in death or serious injury.

NOTE: Locking the handle in the **I (ON)** position does not disable the circuit breaker. If an electrical fault is detected, the circuit breaker trips. When the handle is unlocked, it moves to the **☑ (Trip)** position. To return the circuit breaker to service, reset the circuit breaker, page 38.

The following accessories can be used to lock the toggle handle:

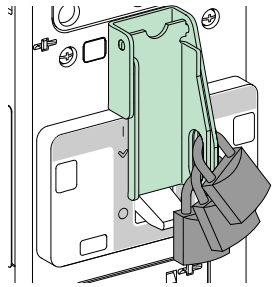
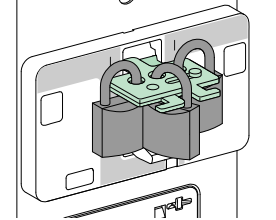
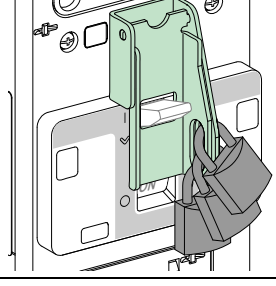
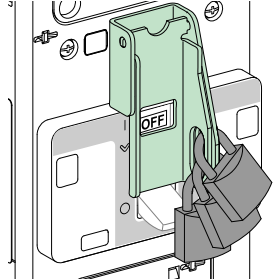
| Locked position | Lock type | Lock characteristics | Lock image |
|--------------------------|---|--|---|
| O (OFF) | Fixed: the device cannot be removed from the case. | Up to 3 padlocks (not supplied) Diameter 4–8 mm (3/16–5/16 in.) |  |
| O (OFF) | Removable: the device can be removed from the case. | Up to 3 padlocks (not supplied) Diameter 4–8 mm (3/16–5/16 in.) |  |
| I (ON) or O (OFF) | Fixed: the device cannot be removed from the case. | Up to 3 padlocks (not supplied) Diameter 4–8 mm (3/16–5/16 in.) | Locked in the I (ON) position.  |
| | | | Locked in the O (OFF) position.  |

Operating a Circuit Breaker with Direct Rotary Handle

What's in This Chapter

| | |
|--|----|
| Description | 43 |
| Opening, Closing, Resetting, and Testing the Circuit Breaker | 45 |
| Locking the Circuit Breaker | 48 |

Description

Front Face

The following figure shows the controls and indicators for a 3-pole circuit breaker with a direct rotary handle. The location of controls and indicators may differ for the other types of circuit breakers. Information about the other parts of the front face is available in the general description, page 10.

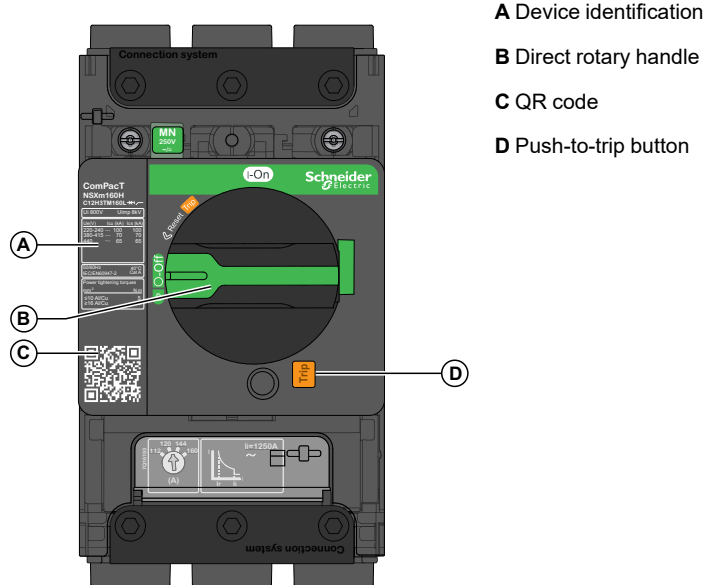

Device Identification

The following figure shows an example of the device identification for a circuit breaker with a direct rotary handle. Your circuit breaker may have different values.

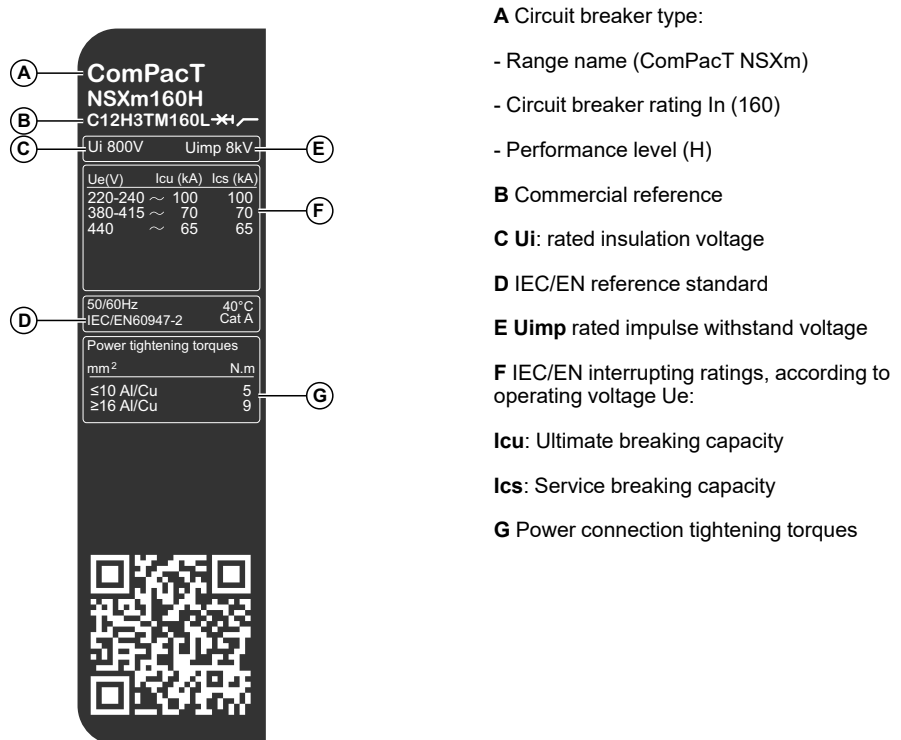

QR Code

Scan the QR code to get additional information about the circuit breaker from the Schneider Electric website. To scan the QR code, use a smartphone that is equipped with a camera and installed with a QR code reader.

Opening, Closing, Resetting, and Testing the Circuit Breaker

Opening and Closing with the Direct Rotary Handle

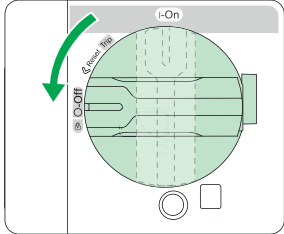
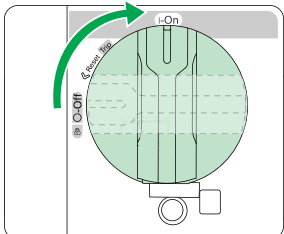
| Task | Action | |
|---------------------------|--|---|
| Open the circuit breaker | Turn the rotary handle from the I (ON) position to the O (OFF) position. |  <p>The diagram shows a top-down view of the circuit breaker handle. A green arrow indicates a counter-clockwise rotation from the 'I-On' position (top) to the 'O-Off' position (left). The handle is currently in the 'I-On' position.</p> |
| Close the circuit breaker | Turn the rotary handle from the O (OFF) position to the I (ON) position. |  <p>The diagram shows a top-down view of the circuit breaker handle. A green arrow indicates a clockwise rotation from the 'O-Off' position (left) to the 'I-On' position (top). The handle is currently in the 'O-Off' position.</p> |

Resetting with the Direct Rotary Handle After a Trip

When the circuit breaker trips, the rotary handle moves from the **I (ON)** position to the **Trip** position.

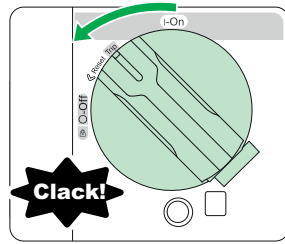

⚠ WARNING

HAZARD OF CLOSING ON ELECTRICAL FAULT

Do not close the circuit breaker again without first inspecting and, if necessary, repairing the downstream electrical equipment.

Failure to follow these instructions can result in death, serious injury, or equipment damage.

The fact that a circuit breaker has tripped does not fix the cause of the fault detected on the downstream electrical equipment.

Follow these steps to reset the circuit breaker after a trip caused by an electrical fault.

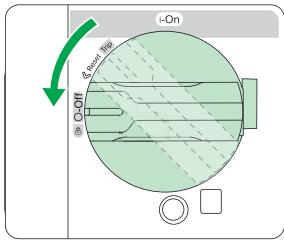
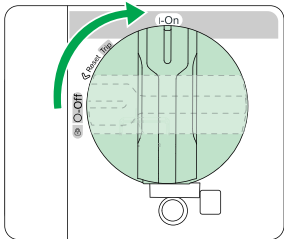
| Step | Action | | Position |
|------|---|---|----------------|
| 1 | Turn the rotary handle from the Trip position to the O (OFF) position. The circuit breaker resets and is open. |  | O (OFF) |
| 2 | Take precautions to protect yourself, page 94. | – | O (OFF) |
| 3 | Look for the cause of the detected fault, page 94. | – | O (OFF) |
| 4 | Clean and test the downstream equipment and the circuit breaker, page 95. | – | O (OFF) |
| 5 | Turn the rotary handle from the O (OFF) position to the I (ON) position. The circuit breaker is closed. |  | I (ON) |

Testing the Trip Mechanism

⚠ CAUTION

HAZARD OF NUISANCE TRIPPING

Circuit breaker tests must only be done by qualified electrical personnel.

Failure to follow these instructions can result in injury or equipment damage.

When testing the trip mechanism, take precautions against:

- Disrupting operations
- Activating inappropriate alarms
- Triggering unwanted actions

For example, tripping the circuit breaker with the push-to-trip button can lead to inappropriate fault indications or corrective actions (such as switching to an alternate power source).

Follow these steps to test the trip mechanism.

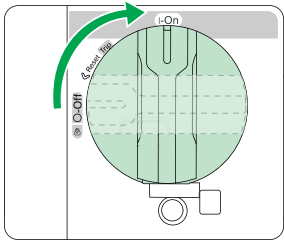
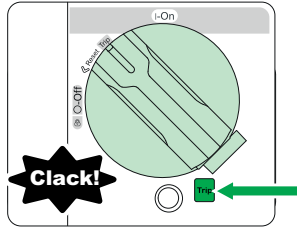
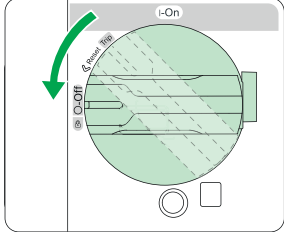
| Step | Action | | Position |
|------|---|---|----------------|
| 1 | Turn the rotary handle from the O (OFF) position to the I (ON) position. The circuit breaker is closed. |  | I (ON) |
| 2 | Press the Trip button. The handle moves from the I (ON) position to the Trip position. The circuit breaker is tripped. |  | Trip |
| 3 | Turn the rotary handle from the Trip position to the O (OFF) position. The circuit breaker is reset. |  | O (OFF) |

Locking the Circuit Breaker

Locking Options with the Direct Rotary Handle

⚡⚠ DANGER

HAZARD OF ELECTRIC SHOCK, EXPLOSION, OR ARC FLASH

When the circuit breaker handle is locked in the **(O) OFF** position, always use a properly rated voltage sensing device to confirm that power is off before working on equipment.

Failure to follow these instructions will result in death or serious injury.

The direct rotary handle offers the following locking options:

- Prevent the door from being opened if the door interlock was activated at installation time
- Prevent the rotary handle from being operated

The handle can be locked in the **O (OFF)** or **I (ON)** position.

No setup is required to lock the handle in the **O (OFF)** position.

Before the handle can be locked in the **I (ON)** position, the rotary handle block must be dismantled and the physical setup of the handle must be changed. This is usually done at installation. For information about how to set up the handle to be locked in the **I (ON)** position, see the relevant instruction sheet, page 6.

NOTE: Locking the rotary handle in the **I (ON)** position does not disable the circuit breaker. If an electrical fault is detected, the circuit breaker still trips. When the rotary handle is unlocked, it moves to the **Trip** position.

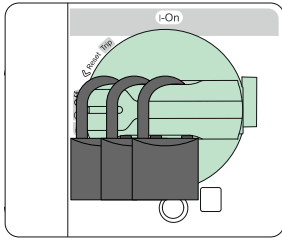
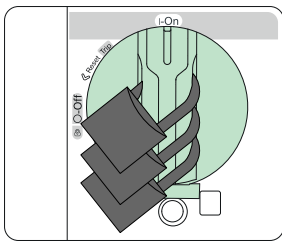
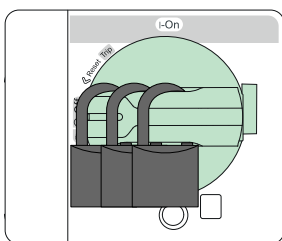
| Lock position | Lock type | Lock characteristics | Lock image |
|--------------------------|--|--|---|
| O (OFF) | Standard padlocking | Up to 3 padlocks (not supplied) Diameter: 4–8 mm (3/16–5/16 in.) |  |
| I (ON) or O (OFF) | Padlocking after modification of the rotary handle during installation | Up to 3 padlocks (not supplied) Diameter: 4–8 mm (3/16–5/16 in.) |  |
| | | |  |

Inserting Padlocks in the Handle

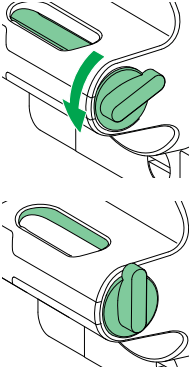
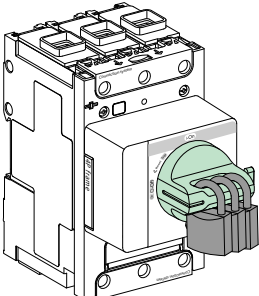
| Step | Action | Comment |
|------|---|---|
| 1 | With the handle in the O (OFF) or I (ON) position, turn the knob as illustrated until the slot in the handle opens. |  <p>The diagram consists of two parts. The top part shows a close-up of the handle knob with a green arrow indicating a clockwise rotation. The bottom part shows the knob after rotation, with a slot in the handle opening up.</p> |
| 2 | Insert the padlocks in the slot. |  <p>The diagram shows a perspective view of a circuit breaker unit. The handle is extended, and several grey padlocks are shown inserted into the slot on the handle.</p> |

Overriding the Door Interlock

⚡ ⚠ DANGER

HAZARD OF ELECTRIC SHOCK, EXPLOSION, OR ARC FLASH

Overriding the door interlock must only be done by qualified electrical personnel.

Failure to follow these instructions will result in death or serious injury.

If it was activated at the time of installation, the interlock between the door and the circuit breaker allows you to open the door only when the circuit breaker is open and the rotary handle is in the **O (OFF)** position.

When the rotary handle is in the **I (ON)** position or the **Trip** position, the door interlock prevents you from opening the door. To open the door, you must turn the handle to the **O (OFF)** position.

Under exceptional circumstances, qualified electrical personnel can follow these steps to open the door while the rotary handle is in the **I (ON)** position or the **Trip** position:

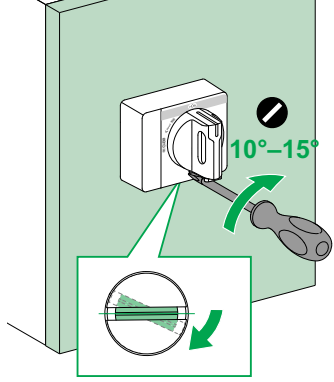
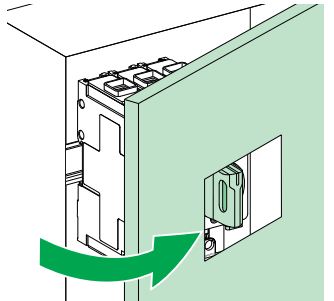
| Step | Action | |
|------|---|---|
| 1 | Using a screwdriver, turn the locking screw clockwise by 10 to 15 degrees and then hold the screwdriver in place. |  |
| 2 | Still holding the screwdriver in place, open the door and then release the locking screw. |  |

To close the door, use a screwdriver to turn the locking screw clockwise by 10 to 15 degrees. Holding the screwdriver in place, close the door and then release the locking screw.

Operating a Circuit Breaker with Front Extended Rotary Handle

What's in This Chapter

| | |
|--|----|
| Description | 52 |
| Opening, Closing, Resetting, and Testing the Circuit Breaker | 53 |
| Locking the Circuit Breaker | 57 |

Description

Front Face

The controls, indicators, and locking mechanism are located on the following parts of the circuit breaker:

- The operating control is on the enclosure door.
- The operation indicators are on the circuit breaker and on the door plate.
- The locking mechanism is on the circuit breaker (door open) or on the door plate (door closed).

To operate the circuit breaker when the door is open, use an open door shaft operator, available as an accessory.

The following figures show the controls and indicators for a circuit breaker with a front extended rotary handle. Information about the other parts of the front face is available in the general description, page 10.

Cabinet door open

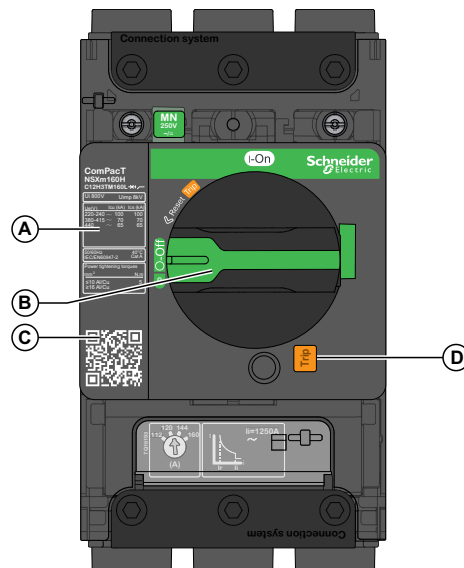

- A** Device identification
- B** Open door shaft operator
- C** QR code
- D** Push-to-trip button

Cabinet door closed

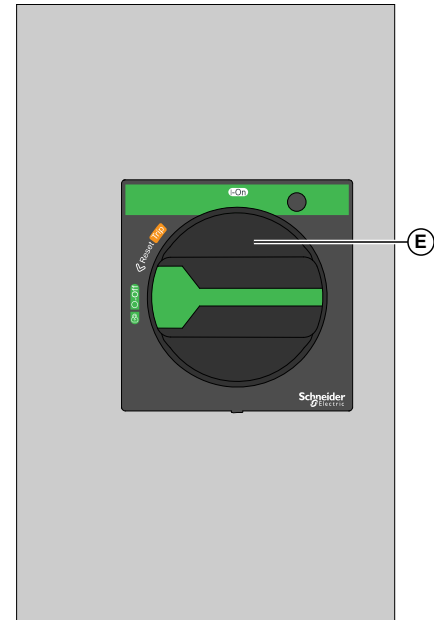

- E** Door operator

Device Identification

Information about the circuit breaker is given on the device identification label, page 43.

QR Code

Scan the QR code to get additional information about the circuit breaker from the Schneider Electric website. To scan the QR code, use a smartphone that is equipped with a camera and installed with a QR code reader.

Opening, Closing, Resetting, and Testing the Circuit Breaker

Opening and Closing with the Front Extended Rotary Handle

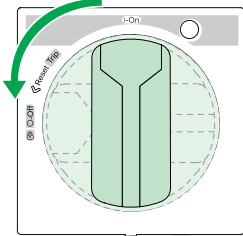
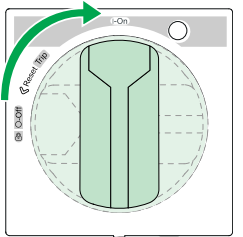
| Task | Action | |
|---------------------------|--|--|
| Open the circuit breaker | Turn the rotary handle from the I (ON) position to the O (OFF) position. |  <p>The diagram shows a top-down view of the circuit breaker's rotary handle. The handle is currently in the 'I (ON)' position, which is the rightmost position. A green arrow indicates a counter-clockwise rotation to the 'O (OFF)' position, which is the leftmost position. The handle has a central vertical slot and is surrounded by a circular frame with dashed lines indicating the rotation path.</p> |
| Close the circuit breaker | Turn the rotary handle from the O (OFF) position to the I (ON) position. |  <p>The diagram shows a top-down view of the circuit breaker's rotary handle. The handle is currently in the 'O (OFF)' position, which is the leftmost position. A green arrow indicates a clockwise rotation to the 'I (ON)' position, which is the rightmost position. The handle has a central vertical slot and is surrounded by a circular frame with dashed lines indicating the rotation path.</p> |

Resetting the Front Extended Rotary Handle After a Trip

When the circuit breaker trips, the rotary handle moves from the **I (ON)** position to the **Trip** position.

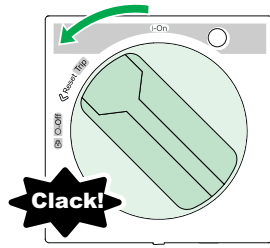

⚠ WARNING

HAZARD OF CLOSING ON ELECTRICAL FAULT

Do not close the circuit breaker again without first inspecting and, if necessary, repairing the downstream electrical equipment.

Failure to follow these instructions can result in death, serious injury, or equipment damage.

The fact that a circuit breaker has tripped does not fix the cause of the fault detected on the downstream electrical equipment.

Follow these steps to reset the circuit breaker after a trip caused by an electrical fault.

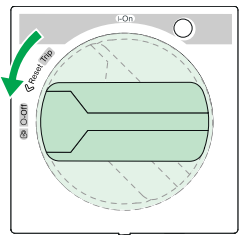
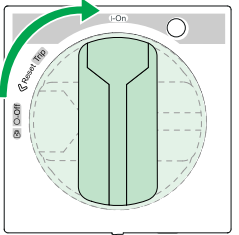
| Step | Action | | Position |
|------|---|---|----------------|
| 1 | Turn the handle from the Trip position to the O (OFF) position. The circuit breaker is open. |  | O (OFF) |
| 2 | Take precautions to protect yourself, page 94. | — | O (OFF) |
| 3 | Look for the cause of the detected fault, page 94. | — | O (OFF) |
| 4 | Clean and test the downstream equipment and the circuit breaker, page 95. | — | O (OFF) |
| 5 | Turn the handle from the O (OFF) position to the I (ON) position. The circuit breaker is closed. |  | I (ON) |

Testing the Trip Mechanism

⚠ CAUTION

HAZARD OF NUISANCE TRIPPING

Circuit breaker tests must only be done by qualified electrical personnel.

Failure to follow these instructions can result in injury or equipment damage.

When testing the trip mechanism take precautions against:

- Disrupting operations
- Activating inappropriate alarms
- Triggering unwanted actions

For example, tripping the circuit breaker with the push-to-trip button can lead to inappropriate fault indications or corrective actions (such as switching to an alternate power source).

There is no push-to-trip button on the door of a circuit breaker with a front extended rotary handle. To check the trip mechanism, the door must first be opened.

Follow these steps to test the trip mechanism.

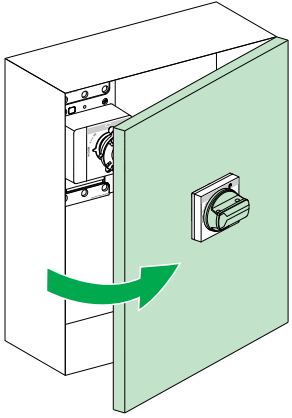
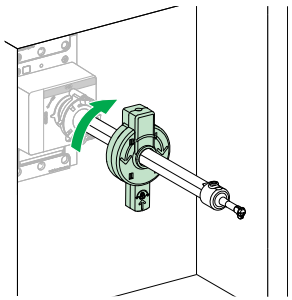
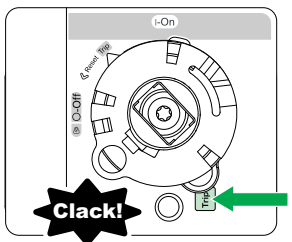
| Step | Action | | Position |
|------|---|---|----------------|
| 1 | With the circuit breaker in the O (OFF) position, open the door. |  | O (OFF) |
| 2 | Turn the circuit breaker from the O (OFF) position to the I (ON) position, using one of the following tools: <ul style="list-style-type: none"> • An open door shaft operator (LV426937). • A flat wrench, taking care not to damage the extension shaft or its surface treatment. The extension shaft is a hollow rectangular tube, 15 x 10 mm (0.59 x 0.39 in.). The circuit breaker is ready for the test. |  | I (ON) |
| 3 | Press the push-to-trip button. The circuit breaker trips. |  | Trip |

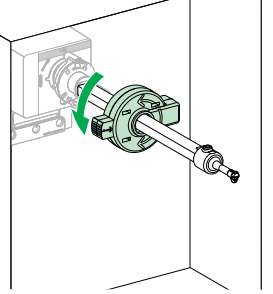
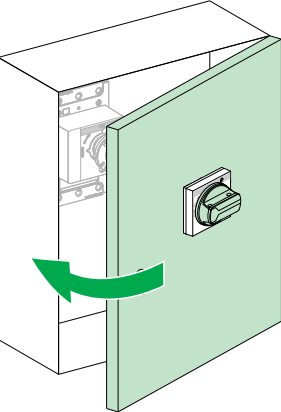
| Step | Action | | Position |
|------|---|---|----------------|
| 4 | Turn the circuit breaker from the Trip position to the O (OFF) position. The circuit breaker is open. |  | O (OFF) |
| 5 | Close the door. |  | - |

Locking the Circuit Breaker

Locking Options for the Front Extended Rotary Handle

⚠️⚠️ DANGER

HAZARD OF ELECTRIC SHOCK, EXPLOSION, OR ARC FLASH

When the circuit breaker handle is locked in the **(O) OFF** position, always use a properly rated voltage sensing device to confirm that power is off before working on equipment.

Failure to follow these instructions will result in death or serious injury.

The extended rotary handle offers the following locking options:

- Prevent the door from being opened
- Prevent the rotary handle from being operated
- Prevent the circuit breaker itself from being operated

The handle can be locked in the **O (OFF)** position or, in the case of the black door operator, in the **I (ON)** position.

No setup is required to lock the handle in the **O (OFF)** position.

Before the handle can be locked in the **I (ON)** position, the door operator must be dismantled and the physical setup of the handle must be changed. This is usually done at installation. For information about how to set up the handle to be locked in the **I (ON)** position, see the relevant instruction sheet, page 6.

NOTE: Locking the rotary handle in the **I (ON)** position does not disable the circuit breaker. If there is a fault detection, the circuit breaker still trips. When the rotary handle is unlocked, it moves to the **Trip** position.

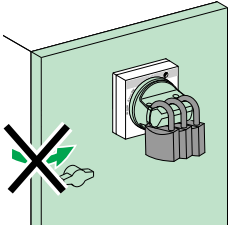
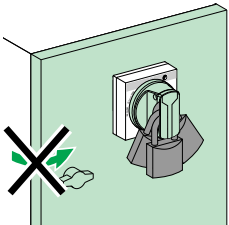
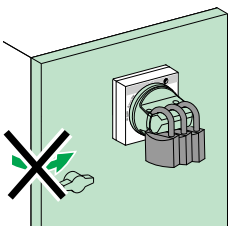
| Lock position | Lock type | Lock characteristics | Lock image |
|--|--|---|---|
| O (OFF) | Standard padlocking | Up to 3 padlocks (not supplied) Diameter: 4–8 mm (3/16–5/16 in.) |  |
| I (ON) or O (OFF) (Black door operator only) | Padlocking after modification of the door operator during installation | Up to 3 padlocks (not supplied) Diameter: 4–8 mm (3/16–5/16 in.) |  |
| | | |  |

Inserting Padlocks in the Handle

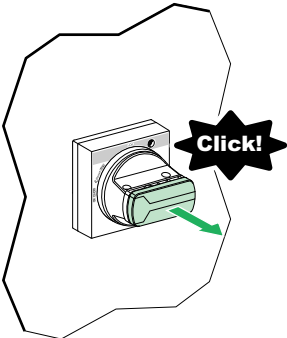
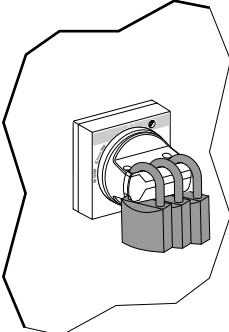
| Step | Action | Comment |
|------|---|---|
| 1 | With the handle in the O (OFF) or I (ON) position, pull the cover on the front of the handle until you hear a click. A space opens between the handle and the cover. |  |
| 2 | Insert the padlocks in the space. |  |

Locking the Circuit Breaker in the O (OFF) Position When the Door Is Open

The following procedure explains how to lock the circuit breaker itself, instead of the handle.

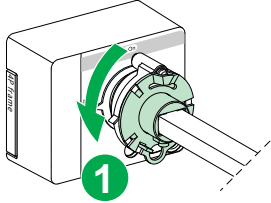
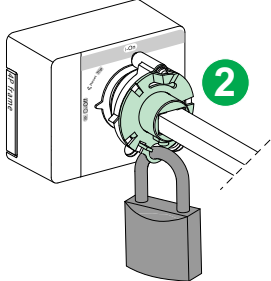
| Step | Action | Comment |
|------|---|---|
| 1 | With the circuit breaker in the O (OFF) position, turn the locking plate anti-clockwise by 60 degrees to align the holes for the lock. |  |
| 2 | Put a padlock or safety lockout hasp (4–8 mm, (3/16–5/16 in.)) in the hole to lock the circuit breaker in the O (OFF) position. |  |

Overriding the Door Interlock

⚠️ DANGER

HAZARD OF ELECTRIC SHOCK, EXPLOSION, OR ARC FLASH

Overriding the door interlock must only be done by qualified electrical personnel.

Failure to follow these instructions will result in death or serious injury.

An interlock between the door and the circuit breaker position allows you to open the door only when the circuit breaker is open and the rotary handle is in the **O (OFF)** position.

When the rotary handle is in the **I (ON)** position or the **Trip** position, the door interlock prevents you from opening the door. To open the door, you must turn the handle to the **O (OFF)** position.

Under exceptional circumstances, qualified electrical personnel can follow these steps to open the door while the rotary handle is in the **I (ON)** position or the **Trip** position:

| Step | Action | |
|------|--|--|
| 1 | Using a screwdriver, turn the locking screw clockwise by 60 degrees and hold the screwdriver in place. | |
| 2 | Open the door. | |

To close the door, use a screwdriver to turn the locking screw clockwise by 60 degrees. Holding the screwdriver in place, close the door and then release the locking screw.

Operating a Circuit Breaker with Side Rotary Handle

What's in This Chapter

| | |
|--|----|
| Description | 61 |
| Opening, Closing, Resetting, and Testing the Circuit Breaker | 62 |
| Locking the Circuit Breaker | 64 |

Description

Front Face

The controls, indicators, and locking mechanism are located on the following parts of the circuit breaker:

- The operating control is on the side plate.
- The operation indicators are on the circuit breaker and on the side plate.
- The locking mechanism is on the side plate.

The following figure shows the controls and indicators for a circuit breaker with a side rotary handle. Information about the other parts of the front face is available in the general description, page 10.

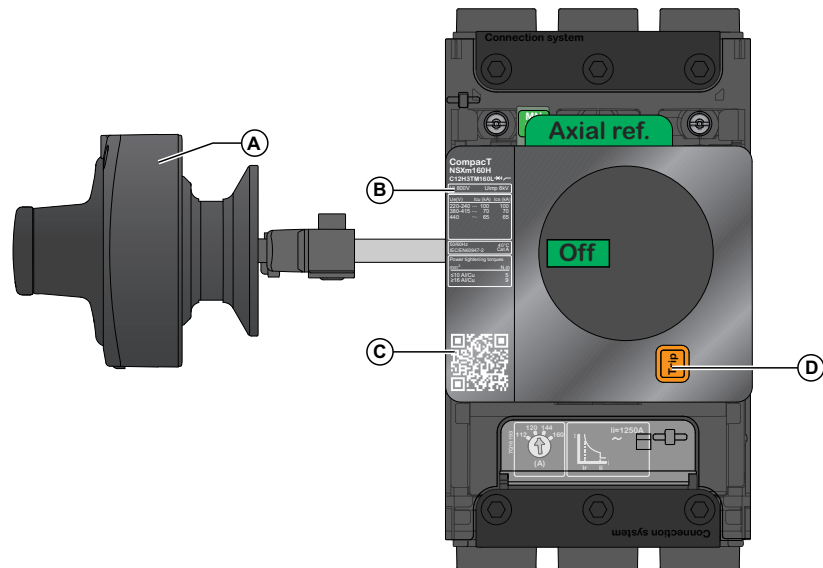

- A** Side rotary handle
- B** Device identification
- C** QR code
- D** Push-to-trip button

Device Identification

Information about the circuit breaker is given on the device identification label, page 43.

QR Code

Scan the QR code to get additional information about the circuit breaker from the Schneider Electric website. To scan the QR code, use a smartphone that is equipped with a camera and installed with a QR code reader.

Opening, Closing, Resetting, and Testing the Circuit Breaker

Opening and Closing with the Side Rotary Handle

| Task | Action |
|--|--------|
| To open the circuit breaker, turn the rotary handle from the I (ON) position to the O (OFF) position. | |
| To close the circuit breaker, turn the rotary handle from the O (OFF) position to the I (ON) position. | |

Resetting with a Side Rotary Handle After a Trip

When the circuit breaker trips, the rotary handle moves from the I (ON) position to the Trip position.

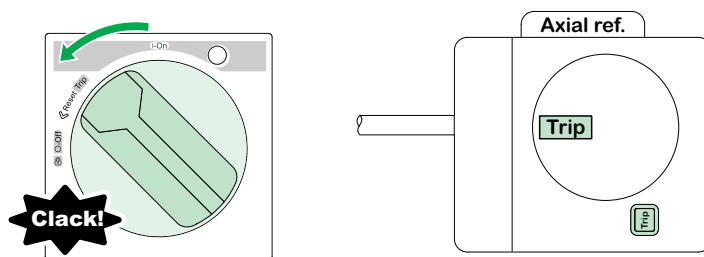

After a trip, reset a circuit breaker with a side rotary handle in the same way as for a circuit breaker with an extended rotary handle, page 54.

Testing the Trip Mechanism

⚠ CAUTION

HAZARD OF NUISANCE TRIPPING

Circuit breaker tests must only be done by qualified electrical personnel.

Failure to follow these instructions can result in injury or equipment damage.

When testing the trip mechanism take precautions against:

- Disrupting operations
- Activating inappropriate alarms
- Triggering unwanted actions

For example, tripping the circuit breaker with the push-to-trip button can lead to inappropriate fault indications or corrective actions (such as switching to an alternate power source).

There is no push-to-trip button on the door of a circuit breaker with a side rotary handle. To check the trip mechanism, the door must first be opened.

Follow these steps to test the trip mechanism.

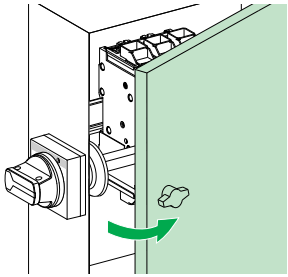
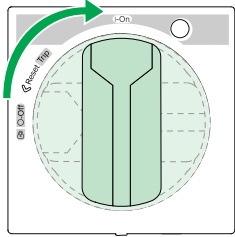
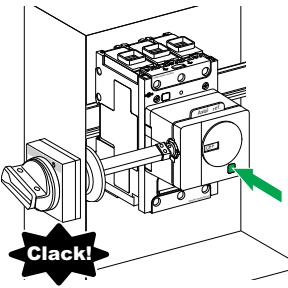
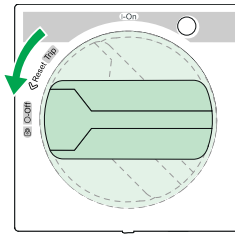
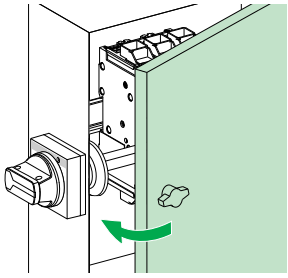
| Step | Action | | Position |
|------|--|---|----------------|
| 1 | With the circuit breaker in the O (OFF) position, open the enclosure door. |  | O (OFF) |
| 2 | Turn the circuit breaker from the O (OFF) position to the I (ON) position. The circuit breaker is ready for the test. |  | I (ON) |
| 3 | Press the push-to-trip button. The circuit breaker trips. |  | Trip |
| 4 | Turn the circuit breaker from the Trip position to the O (OFF) position. The circuit breaker is open. |  | O (OFF) |
| 5 | Close the door. |  | — |

Locking the Circuit Breaker

Locking Options with a Side Rotary Handle

⚡⚠ DANGER

HAZARD OF ELECTRIC SHOCK, EXPLOSION, OR ARC FLASH

When the circuit breaker handle is locked in the **(O) OFF** position, always use a properly rated voltage sensing device to confirm that power is off before working on equipment.

Failure to follow these instructions will result in death or serious injury.

The side rotary handle offers a locking option to prevent the rotary handle from being operated.

The handle can be locked in the **O (OFF)** position or, in the case of the black side operator, in the **I (ON)** position.

No setup is required to lock the handle in the **O (OFF)** position.

Before the handle can be locked in the **I (ON)** position, the side operator must be dismantled and the physical setup of the handle must be changed. This is usually done at installation. For information about how to set up the handle to be locked in the **I (ON)**, position, see the relevant instruction sheet, page 6.

NOTE: Locking the rotary handle in the **I (ON)** position does not disable the circuit breaker. If there is a fault detection, the circuit breaker still trips. When the rotary handle is unlocked, it moves to the **Trip** position.

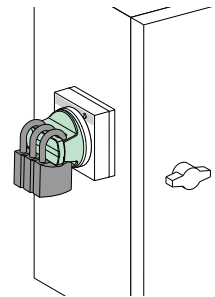
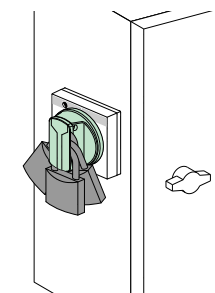
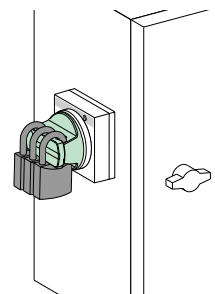
| Lock position | Lock type | Lock characteristics | Lock image |
|--|--|---|---|
| O (OFF) | Standard padlocking | Up to 3 padlocks (not supplied) Diameter: 4–8 mm (3/16–5/16 in.) |  |
| I (ON) or O (OFF) (Black side operator only) | Padlocking after modification of the side operator during installation | Up to 3 padlocks (not supplied) Diameter: 4–8 mm (3/16–5/16 in.) |  |
| | | |  |

Inserting Padlocks in the Handle

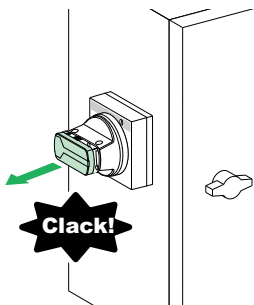
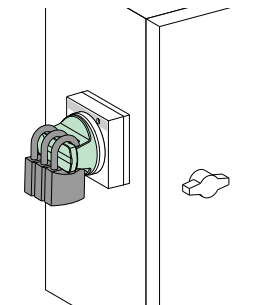
| Step | Action | Comment |
|------|--|---|
| 1 | <p>With the handle in the O (OFF) or I (ON) position, pull the cover on the front of the handle until you hear a click.</p> <p>A space opens between the handle and the cover.</p> |  |
| 2 | <p>Insert the padlocks in the space.</p> |  |

Electrical Auxiliary and Accessory Devices

What's in This Part

| | |
|-------------------------------------|----|
| Electrical Auxiliary Devices | 67 |
| Indication Contacts | 69 |
| Wireless Indication Auxiliary | 71 |
| Voltage Releases | 75 |
| SDx Module | 76 |
| PowerTag Energy F160 | 80 |

Electrical Auxiliary Devices

Summary of Electrical Auxiliary Devices

The following table shows electrical auxiliary devices that can be added to circuit breakers. Electrical auxiliary devices can be installed on site. For more information, see LVPED221001EN, *ComPacT NSX & NSXm Catalogue*.

| Electrical auxiliary device | Use | 3P/4P circuit breaker | 3P/4P ELCB |
|--|---|-----------------------|------------|
| OF indication auxiliary (wired or wireless) | View the on/off status of the circuit breaker remotely. | ✓ | ✓ |
| SD indication auxiliary (wired or wireless) | View the trip status of the circuit breaker remotely. | ✓ | ✓ |
| MX shunt trip | Send an electrical trip command remotely. | ✓ | ✓ |
| MN undervoltage release | Trip the circuit breaker when the control voltage drops below a tripping threshold. | ✓ | ✓ |
| MN undervoltage release with time-delay unit | Intended to avoid nuisance tripping in systems with frequent voltage dips lasting from 200 ms to 3 s. | ✓ | ✓ |
| SDx module | Provide alarm and fault differentiation for the ComPacT NSXm earth-leakage circuit breaker. | – | ✓ |

Slots for Electrical Auxiliary Devices for Circuit Breaker

The following figures show the available slots for electrical auxiliary devices mounted in the circuit breaker case. One auxiliary can be installed in each slot. For more information, see LVPED221001EN, *ComPacT NSX & NSXm Catalogue*.

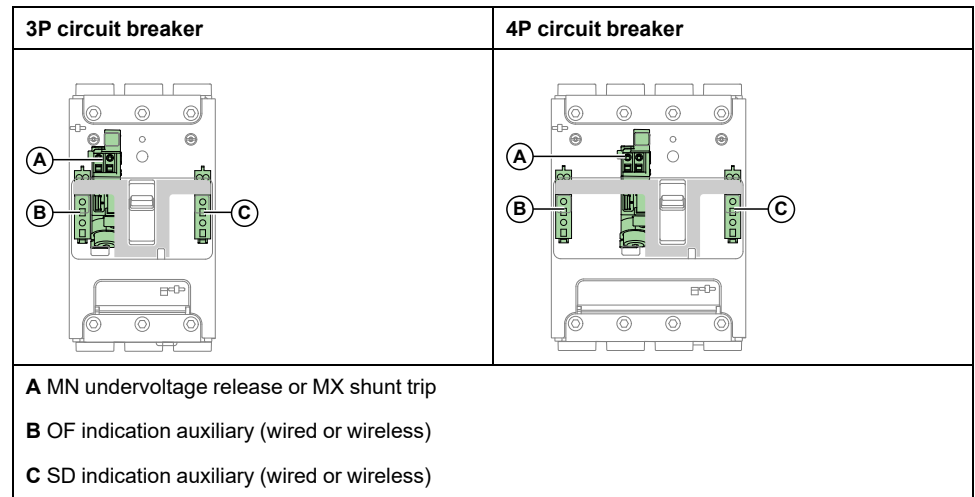

Slots for Electrical Auxiliary Devices for Earth-Leakage Circuit Breaker

The following figures show the available slots for electrical auxiliary devices mounted in the case of the earth-leakage circuit breaker (ELCB). One auxiliary can be installed in each slot.

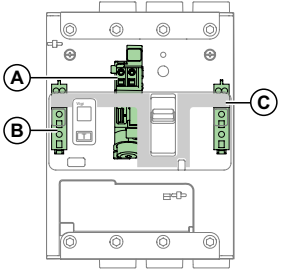
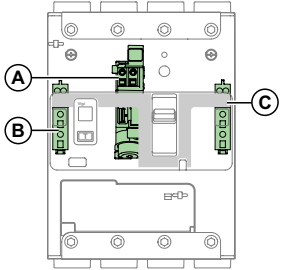
| 3P ELCB | 4P ELCB |
|--|--|
|  |  |
| <p>A MN undervoltage release or MX shunt trip</p> <p>B OF indication auxiliary (wired or wireless)</p> <p>C SD indication auxiliary (wired or wireless)</p> | |

The following figures show the available slots for electrical auxiliary devices mounted outside the earth-leakage circuit breaker (ELCB). Two SDx modules can be installed.

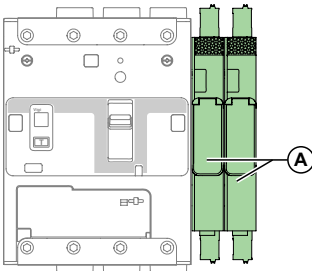
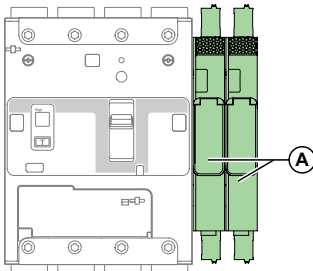
| 3P ELCB | 4P ELCB |
|---|--|
|  |  |
| <p>A SDx module (1 or 2 maximum)</p> | |

For more information, see LVPED221001EN, *ComPacT NSX & NSXm Catalogue*.

Indication Contacts

Characteristics of Indication Contacts

Use indication contacts to view the status of the circuit breaker remotely.

Indication contacts are located under the front face of the circuit breaker, in a compartment that is isolated from the power circuits. When an indication contact is present, a green flag is displayed on the front of the circuit breaker.

The contacts used for indication contacts are common point changeover contacts.

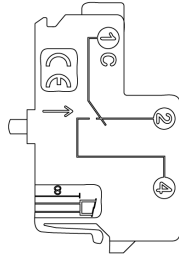

C(1) Common

NC(2) Normally closed contact. The NC contact is normally closed when the circuit breaker is in the **O (OFF)** position.

NO(4) Normally open contact. The NO contact is normally open when the circuit breaker is in the **O (OFF)** position.

NOTE: The indication contact provides either OF or SD indication functions, depending on its location in the circuit breaker.

| Name | Definition |
|------------------------------------|---|
| OF open / close indication contact | <p>The OF contact indicates the state of the circuit breaker, (I (ON) or O (OFF)/ Trip).</p> <p>Changeover</p> <ul style="list-style-type: none"> • O (OFF) to I (ON) • I (ON) to O (OFF) • I (ON) to Trip |
| SD trip indication contact | <p>The SD contact indicates that the circuit breaker has tripped due to:</p> <ul style="list-style-type: none"> • Operation of the push-to-trip button • Operation of the MX shunt trip or MN undervoltage release • Electrical fault detected by the protection <p>Changeover</p> <ul style="list-style-type: none"> • I (ON) to Trip • Trip to O (OFF) |

Operation of the Indication Contacts

The following figures show the position of the indication contacts for each position of the handle and main contacts.

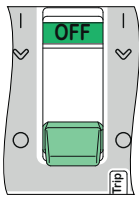
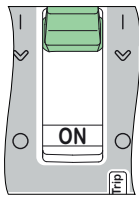
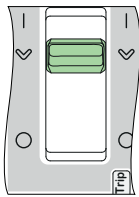
| Name | Contact number | Position of the handle and contacts | | |
|-------------------------------|----------------|--|---|---|
| | | OFF | ON | Tripped (by MN/MX, push-to-trip, or protection) |
| Device status | – | | | Tripped (by MN/MX, push-to-trip, or protection) |
| Handle position | – |  |  |  |
| Main contact position | – | Open | Closed | Open |
| OF auxiliary contact position | 1-2 | Closed | Open | Closed |
| | 1-4 | Open | Closed | Open |
| SD auxiliary contact position | 1-2 | Closed | Closed | Open |
| | 1-4 | Open | Open | Closed |

Wireless Indication Auxiliary

Introduction

The wireless indication auxiliary provides remote and local information about the circuit breaker status.

The position of the wireless indication auxiliary inside the case, page 67, and the setting of the gateway or panel server, determine its function. The wireless indication auxiliary provides the following information remotely:

| Position of wireless indication auxiliary | Information provided |
|---|-----------------------------------|
| OF slot | Open/close circuit breaker status |
| SD slot | Trip indication |

When in the SD slot, the wireless indication auxiliary can be configured to indicate a circuit breaker trip locally. The status LED blinks orange for eight hours.

The wireless indication auxiliary must be paired with a gateway or panel server.

The wireless indication auxiliary is powered by an internal battery. It sends a notification to indicate that the battery needs to be replaced.

For more information about installation, consult the instruction sheets on the Schneider Electric website: NNZ8881001 *Wireless Indication Auxiliary Instruction Sheet*

Description

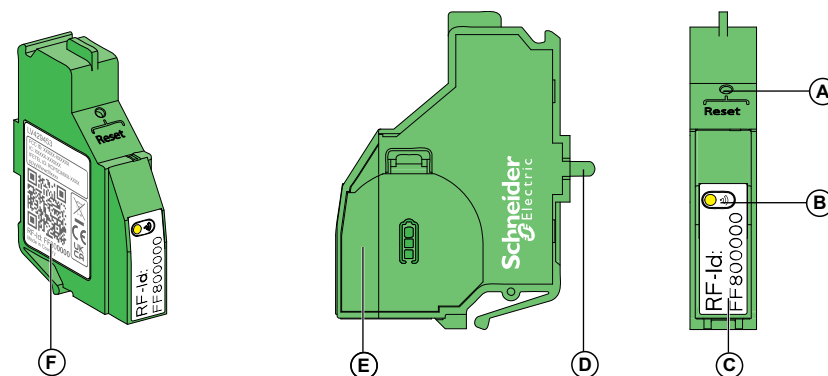

A Reset button

B Status LED

C RF-Id identifier

D Actuator

E Battery cover

F QR code to access device information, including wireless address

Reset Button





The reset button allows you to :

- Access setting mode to set the status LED indication mode
- Pair or unpair the wireless indication auxiliary

Status LED

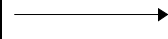
A status LED on the wireless indication auxiliary provides the following information:

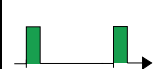
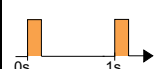
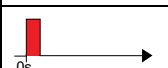
- Help with commissioning and maintenance steps
- Status of communication between wireless indication auxiliary and gateway or panel server
- Status of the wireless indication auxiliary
- Indication of circuit breaker trip (available when LED indication mode is ON).

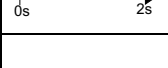
| Status LED | Description | Action |
|--|--|---|
|  | Wireless indication auxiliary switched off or not currently in communication with gateway or panel server. | None |
|  | Wireless indication auxiliary in pairing mode, searching for a gateway or panel server. | Wait until the gateway or panel server is identified. |
|  | Wireless indication auxiliary in identification mode. | Wait until wireless indication auxiliary is discovered in network. |
|  | Wireless indication auxiliary in communication. One green flash at each frame sent. | None |
|  | Trip indication when wireless indication auxiliary is in SD slot and configured in LED indication mode ON | Check tripping cause. |
|  | Occasional loss of communication with the gateway or panel server. | Check communication setting with the gateway or panel server. |
|  | Wireless indication auxiliary in setting mode, with LED indication mode set to OFF. | Set LED indication mode to ON by pressing the Reset button. |
|  | Wireless indication auxiliary in setting mode, with LED indication mode set to ON. | Set LED indication mode to OFF by pressing the Reset button three times in less than two seconds. |
|  Flashes only when actuator is activated | Battery out of power | Change the battery. |

Commissioning

Commission the wireless indication auxiliary by using EcoStruxure Power Commission software or the webpages of the gateway or panel server.

NOTE: Check the firmware of the gateway before performing the commissioning of the wireless indication auxiliary. It is recommended to upgrade to the latest version available.

| Step | Action |
|------|--|
| 1 | <p>Put the wireless indication auxiliary in pairing mode in one of the following ways:</p> <ul style="list-style-type: none"> • If the wireless indication auxiliary is not installed in the circuit breaker, press the reset button or the actuator. • If the wireless indication auxiliary is installed in the OF slot, open and close the circuit breaker. • If the wireless indication auxiliary is installed in the SD slot, open, close and action the push-to-trip button on the circuit breaker. <p>Result: The status LED blinks orange. The wireless indication auxiliary stays in pairing mode for three minutes.</p> |
| 2 | <p>Pair the gateway or panel server with the wireless indication auxiliary by using EcoStruxure Power Commission software or the webpages of the gateway or panel server.</p> <p>Result: The status LED blinks green to indicate that the wireless indication auxiliary is paired.</p> |
| 3 | <p>Configure the wireless indication auxiliary by using EcoStruxure Power Commission software or the webpages of the gateway or panel server.</p> |

Setting LED Indication Mode

Set the LED indication mode of the wireless indication auxiliary to ON to indicate a trip locally when the wireless indication auxiliary is installed in the SD slot. The LED indication mode is factory-set to OFF.

Follow this procedure to change the LED indication mode.

| Step | Action |
|------|--|
| 1 | <p>Press the reset button.</p> <p>Result: the wireless indication auxiliary wakes up.</p> |
| 2 | <p>Press the reset button three times in less than two seconds.</p> <p>Result: The wireless indication auxiliary is in setting mode. the Status LED flashes three times every two seconds if LED indication mode is OFF, or six times every two seconds if LED indication mode is ON.</p> |
| 3 | <p>Press the reset button once to change the LED indication mode from OFF to ON, or from ON to OFF.</p> |
| 4 | <p>To exit setting mode, press the reset button for three seconds.</p> <p>NOTE: If the reset button is not pressed, the wireless indication auxiliary exits setting mode after two minutes.</p> |

Replacing the Internal Battery

The wireless indication auxiliary sends a notification six months before the battery needs to be changed. For more information, see [LVPED217032EN ComPacT NSX & NSXm Catalogue](#).

Follow this procedure to replace the internal battery.

| Step | Action |
|------|---|
| 1 | Remove the wireless indication auxiliary from its slot. Refer to <i>Wireless Indication Auxiliary Instruction Sheet</i> . |
| 2 | Remove the battery cover. |
| 3 | Remove the battery and recycle it. |
| 4 | Insert the new battery, following the guidelines marked in the battery compartment. |
| 5 | Put back the battery cover and lock it. |

| Step | Action |
|------|--|
| 6 | Reinstall the wireless indication auxiliary in its slot. |
| 7 | Put back the front cover of the circuit breaker. |

Replacing the Wireless Indication Auxiliary

Follow this procedure to unpair the wireless indication auxiliary and delete it in EcoStruxure Power Commission software or the webpages of the gateway or panel server before replacing the wireless indication auxiliary.

| Step | Action |
|------|---|
| 1 | Remove the wireless indication auxiliary from its slot. Refer to <i>Wireless Indication Auxiliary Instruction Sheet</i> . |
| 2 | Unpair the wireless indication auxiliary by pressing the reset button for at least three seconds and releasing, or by using EcoStruxure Power Commission software or the webpages of the gateway or panel server. |
| 3 | Install the new wireless indication auxiliary in its slot. |
| 4 | Pair the wireless indication auxiliary by following the procedure in <i>Commissioning</i> , page 72. |
| 5 | Put back the front cover of the circuit breaker. |

Voltage Releases

Characteristics

The following voltage release auxiliaries are operated remotely by an electrical trip command:

- MX shunt trip
- MN undervoltage release
- MN undervoltage release with time-delay unit. The time-delay unit helps to overcome nuisance tripping due to transient voltage dips. The time delay is adjustable up to three seconds.

NOTE: It is recommended to test the operation of a voltage release at regular intervals, such as every six months.

Voltage release auxiliaries are installed in the case under the front face of the circuit breaker. The presence and characteristics of a voltage release auxiliary are displayed through a window on the front face.

The characteristics of voltage release auxiliaries comply with IEC/EN 60947-2 recommendations.

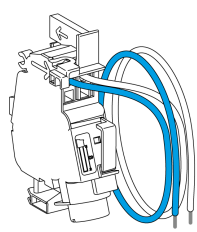
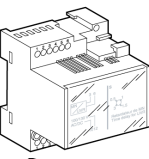
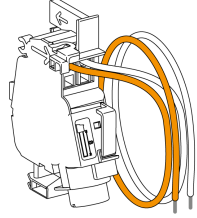
| Name | Image | Description |
|--|---|---|
| MN undervoltage release |  | <ul style="list-style-type: none"> • Trips the circuit breaker when the voltage is less than 0.35 times the rated voltage (U_n). <ul style="list-style-type: none"> ◦ If the voltage is between 0.35 and 0.7 times the rated voltage (U_n), tripping can occur but is not certain to occur. ◦ If the voltage is above 0.7 times the rated voltage (U_n), tripping cannot occur. • Allows the circuit breaker to be closed again when the voltage reaches 0.85 times the rated voltage (U_n). <p>Use this type of accessory for failsafe emergency stops.</p> |
| Time-delay unit for MN undervoltage release |  | <p>Removes nuisance tripping of an undervoltage release by setting a time delay of up to 3 s to overcome transient voltage dips.</p> <p>Adjustable and fixed time-delay units are available.</p> |
| MX shunt trip |  | <p>Trips the circuit breaker when the voltage exceeds 0.7 times the rated voltage (U_n).</p> <p>NOTE: MX shunt trip 110/130 Vac combined with Class I ground-fault sensing element is suitable for ground-fault protection. In this application, the circuit breaker trips when the voltage exceeds 0.55 times the rated voltage (U_n).</p> |

SDx Module

Introduction

One or two optional SDx modules can be installed on an earth-leakage circuit breaker (ELCB).

The SDx module has two outputs and provides alarms and fault differentiation.

The SDx module receives data from the trip unit through an optical link.

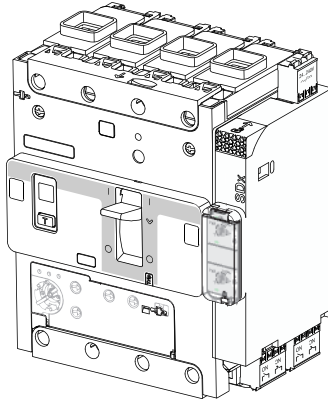

Description

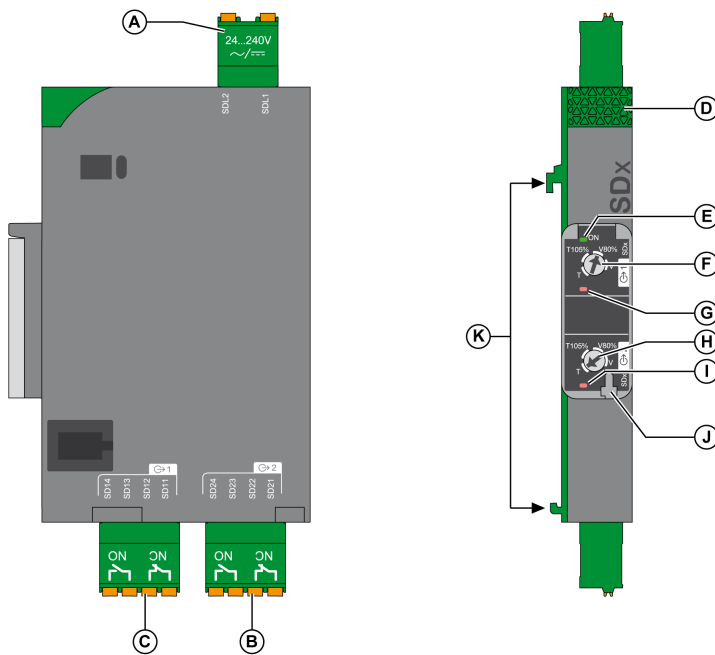

- A** Power supply
- B** Output 2 (1NO+1NC)
- C** Output 1 (1NO+1NC)
- D** Lock knob
- E** SDx module status
 - OFF: SDx module not powered
 - Green: SDx module powered
- F** Output 1 setting dial
- G** Output 1 status LED
 - OFF: output de-activated
 - Red: output activated
- H** Output 2 setting dial
- I** Output 2 status LED
 - OFF: output de-activated
 - Red: output activated
- J** Seal for setting cover
- K** Clips to attach to ELCB

SDx Module Characteristics

Power supply: 24–240 Vac/Vdc

Power:

- 2,000 VA maximum
- 240 W maximum

Output characteristics:

- Voltage: 24–250 Vac/Vdc
- Current: 2 mA–5 A maximum

Output Settings

The function assigned to each output of the SDx module is set by using a setting dial. Each output can be assigned with one of the following indications:

- Overload trip indication (SDT): circuit breaker has tripped due to an overload fault.
- Overload alarm (SDT105%): current is higher than 105% of the setting current (I_r).
- Earth-leakage alarm (SDV80%): leakage current is higher than 80% of the earth-leakage trip threshold ($I_{\Delta n}$).
- Earth-leakage trip indication (SDV): circuit has tripped due to an earth-leakage current.

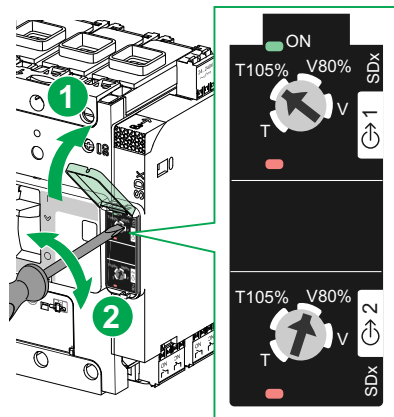

| | |
|--------------|---|
| T | SDT thermal fault indication |
| T105% | SDT thermal alarm: 105% I_r |
| V80% | SDV earth-leakage alarm: 80% $I_{\Delta n}$ |
| V | SDV earth-leakage fault indication |

SDT and SDT105% Operating Modes

Operating modes of the SDT output:

- The output is activated when the circuit breaker trips due to an overload fault.
- The output is reset when the circuit breaker is reset, closed, and energized.

Operating modes of the SDT105% output:

- The output is activated when current is greater than $105\% \times I_r$.
- The output is reset in one of the following cases:
 - The current is lower than $105\% \times I_r$.
 - After tripping, the circuit breaker is reset, closed, and energized.

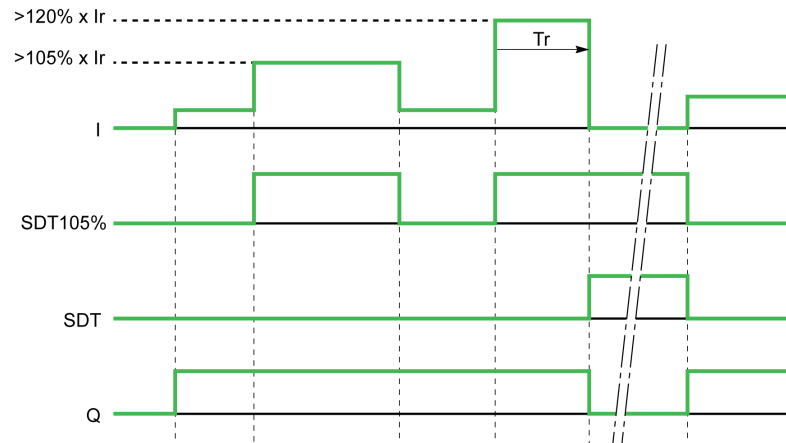

| | |
|---------|--------------------------|
| I | Charge current |
| SDT105% | Thermal alarm |
| SDT | Thermal fault indication |
| Q | Circuit breaker |

SDV and SDV80% Operating Modes

Operating modes of the SDV output:

- The output is activated when the circuit breaker trips due to an earth-leakage fault.
- The output is reset when the circuit breaker is reset, closed, and energized.

Operating modes of the SDV80% output:

- The output is activated when the earth-leakage current is greater than $80\% \times I_{\Delta n}$ for more than 5 seconds.
- The output is reset in one of the following cases:
 - The current is lower than $80\% \times I_{\Delta n}$.
 - After tripping, the circuit breaker is reset, closed, and energized.

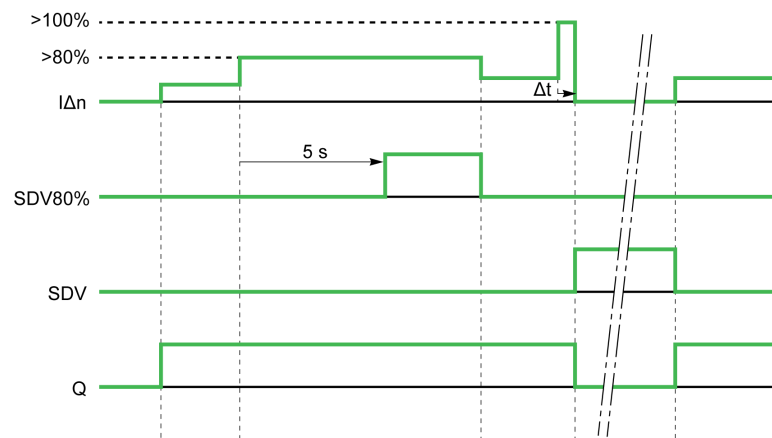

| | |
|----------------|--------------------------------|
| $I_{\Delta n}$ | Earth-leakage current |
| SDV80% | Earth-leakage alarm |
| SDV | Earth-leakage fault indication |
| Q | Circuit breaker |

PowerTag Energy F160

Introduction

The PowerTag Energy F160 is suitable for molded case circuit breakers and switch-disconnectors (ComPacT NSXm and ComPact INS) for 3P and 3P+N electrical networks.

The PowerTag Energy F160 is mounted above or below the circuit breaker using conductor feedthroughs for current measurement. .

NOTE: It is recommended to mount the PowerTag Energy F160 below the circuit breaker to benefit from the voltage loss alarm function. For more information, refer to CA908058E PowerTag Energy Selection Guide

With its Flex design, the PowerTag Energy F160 is mounted directly on the power cables. Voltage take-off must be wired, using the recommended EverLink connectors with control wire terminal (LV426970 for 3P, LV426971 for 4P).

The PowerTag Energy F160 must be associated with a concentrator or gateway.

For more information about installation, consult the instruction sheet on the Schneider Electric website: MFR85580 *PowerTag F160 3P/3P+N – Instruction Sheet*

Description

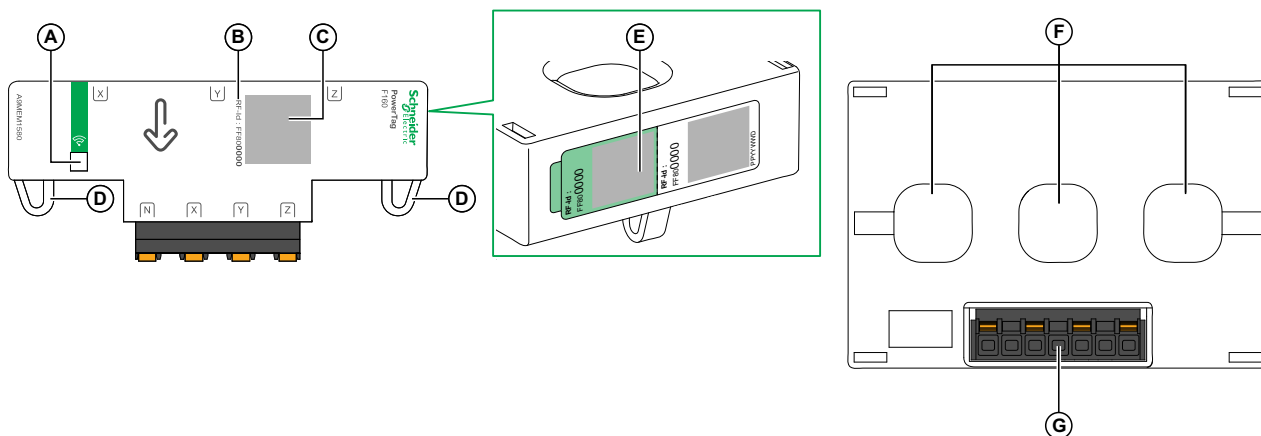

A Status LED

B RF-Id identifier

C QR code to access device information

D Cable tie brackets





E Label with a detachable adhesive part carrying the QR code and the **RF-Id** identifier

F Conductor feedthroughs for current measurement

G Removable connector for voltage take-off connection

Status LED

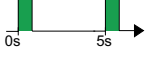
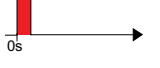
Use the LED indication to confirm that the PowerTag Energy F160 is working during commissioning or maintenance operations.

| Status LED | Description | Action |
|---|---|---|
|  | PowerTag Energy F160 switched off. | None or check power supply depending on operation type. |
|  | PowerTag Energy F160 searching a concentrator or gateway. | Wait until the concentrator or gateway is identified. |
|  | PowerTag Energy F160 in identification mode. | Wait until PowerTag Energy F160 is in network. |
|  | PowerTag Energy F160 in network. Normal communication with the concentrator or gateway. | None |
|  | Occasional loss of communication. | Check communication setting with the concentrator or gateway. |
|  | Loss of communication with the concentrator or gateway. | Check communication setting with the concentrator or gateway. |
|  | Internal error detected. | Replace the PowerTag Energy F160 . |

Data Available

The following table lists data available for the following PowerTag Energy F160:

- PowerTag Energy F160 without neutral connection
- PowerTag Energy F160 with neutral connection

| Data | Measurement | PowerTag Energy F160 | |
|---------|--|----------------------------|-------------------------|
| | | Without neutral connection | With neutral connection |
| Current | RMS Current on phase A | ✓ | ✓ |
| | RMS Current on phase B | ✓ | ✓ |
| | RMS Current on phase C | ✓ | ✓ |
| Voltage | RMS Phase-to-phase voltage A-B | ✓ | ✓ |
| | RMS Phase-to-phase voltage B-C | ✓ | ✓ |
| | RMS Phase-to-phase voltage C-A | ✓ | ✓ |
| | RMS Phase-to-neutral voltage A-N | – | ✓ |
| | RMS Phase-to-neutral voltage B-N | – | ✓ |
| | RMS Phase-to-neutral voltage C-N | – | ✓ |
| Power | Total active power | ✓ | ✓ |
| | Active power on phase A | – | ✓ |
| | Active power on phase B | – | ✓ |
| | Active power on phase C | – | ✓ |
| | Total reactive power | ✓ | ✓ |
| | Reactive power on phase A | – | ✓ |
| | Reactive power on phase B | – | ✓ |
| | Reactive power on phase C | – | ✓ |
| | Total apparent power (arithmetic) | ✓ | ✓ |
| | Apparent power (arithmetic) on phase A | – | ✓ |
| | Apparent power (arithmetic) on phase B | – | ✓ |

| Data | Measurement | PowerTag Energy F160 | |
|--------------------|--|----------------------------|-------------------------|
| | | Without neutral connection | With neutral connection |
| | Apparent power (arithmetic) on phase C | – | ✓ |
| Power Factor | Total power factor | ✓ | ✓ |
| | Power factor on phase A | – | ✓ |
| | Power factor on phase B | – | ✓ |
| | Power factor on phase C | – | ✓ |
| Frequency | AC Frequency | ✓ | ✓ |
| Device temperature | Device internal temperature | ✓ | ✓ |
| Energy | Total active energy delivered, non resettable | ✓ | ✓ |
| | Total active energy received, non resettable | ✓ | ✓ |
| | Active energy on phase A delivered, non resettable | – | ✓ |
| | Active energy on phase A received, non resettable | – | ✓ |
| | Active energy on phase B delivered, non resettable | – | ✓ |
| | Active energy on phase B received, non resettable | – | ✓ |
| | Active energy on phase C delivered, non resettable | – | ✓ |
| | Active energy on phase C received, non resettable | – | ✓ |
| | Partial active energy delivered, resettable | ✓ | ✓ |
| | Partial active energy received, resettable | ✓ | ✓ |
| | Partial active energy on phase A delivered, non resettable | – | ✓ |
| | Partial active energy on phase A received, non resettable | – | ✓ |
| | Partial active energy on phase B delivered, non resettable | – | ✓ |
| | Partial active energy on phase B received, non resettable | – | ✓ |
| | Partial active energy on phase C delivered, non resettable | – | ✓ |
| | Partial active energy on phase C received, non resettable | – | ✓ |
| | Partial reactive energy delivered, resettable | ✓ | ✓ |
| | Partial reactive energy received, resettable | ✓ | ✓ |
| | Partial reactive energy on phase A delivered, non resettable | – | ✓ |
| | Partial reactive energy on phase A received, non resettable | – | ✓ |
| | Partial reactive energy on phase B delivered, non resettable | – | ✓ |
| | Partial reactive energy on phase B received, non resettable | – | ✓ |
| | Partial reactive energy on phase C delivered, non resettable | – | ✓ |
| | Partial reactive energy on phase C received, non resettable | – | ✓ |
| | Total apparent energy | ✓ | ✓ |
| | Apparent energy on phase A | – | ✓ |
| | Apparent energy on phase B | – | ✓ |
| | Apparent energy on phase C | – | ✓ |
| | Partial apparent energy | ✓ | ✓ |
| | Partial apparent energy on phase A | – | ✓ |
| | Partial apparent energy on phase B | – | ✓ |
| | Partial apparent energy on phase C | – | ✓ |
| Alarm | Alarms | ✓ | ✓ |

| Data | Measurement | PowerTag Energy F160 | |
|------|--|----------------------------|-------------------------|
| | | Without neutral connection | With neutral connection |
| | <ul style="list-style-type: none"> Voltage loss Current overload at voltage loss | | |
| | RMS Current on Phase A at voltage loss (last RMS current measured when voltage loss occurred) | ✓ | ✓ |
| | RMS Current on Phase B at voltage loss (last RMS current measured when voltage loss occurred) | ✓ | ✓ |
| | RMS Current on Phase C at voltage loss (last RMS current measured when voltage loss occurred) | ✓ | ✓ |

Commissioning

Commission the PowerTag Energy F160 by using EcoStruxure Power Commission software or the embedded webpages of the gateway or panel server, if any.

NOTE: Check the firmware of the gateway before performing the commissioning of PowerTag Energy F160. It is recommended to upgrade to the latest version available.

For automatic pairing the PowerTag Energy F160 must be powered and the Status LED must be flashing fast orange.

If the LED is flashing fast red (loss of communication status), turn the power off and on to reset the PowerTag Energy F160. If the PowerTag Energy F160 is not paired within two minutes, it returns to loss of communication status.

If the LED is blinking green, PowerTag Energy F160 is already paired with a gateway. Unpair it before pairing with a new gateway.

Commissioning and Maintenance

What's in This Part

| | |
|---|----|
| Commissioning the Circuit Breaker | 85 |
| Maintaining the Circuit Breaker During Operation..... | 91 |
| Responding to a Trip | 94 |
| Troubleshooting | 96 |

Commissioning the Circuit Breaker

List of Checks and Inspections

⚡ ⚠ DANGER

HAZARD OF ELECTRIC SHOCK, EXPLOSION, OR ARC FLASH

- Apply appropriate personal protective equipment (PPE) and follow safe electrical work practices. See NFPA 70E, CSA Z462, NOM-029-STPS, or local equivalent.
- This equipment must only be installed and serviced by qualified electrical personnel.
- Turn off all power supplying this equipment before working on or inside equipment.
- Always use a properly rated voltage sensing device to confirm that power is off.
- Replace all devices, doors, and covers before turning on power to this equipment.
- Beware of potential hazards, and carefully inspect the work area for tools and objects that may have been left inside the equipment.

Failure to follow these instructions will result in death or serious injury.

When starting up new equipment, or following lengthy downtime, a general check takes just a few minutes. Such a check reduces the risk of a malfunction due to error or oversight.

The following table indicates the checks and inspections to be performed according to the event:

| When to carry out the check or inspection | A | B | C | D | E | F | G | H | I | J | K |
|--|---|---|---|---|---|---|---|---|---|---|---|
| Before commissioning | ✓ | ✓ | ✓ | ✓ | ✓ | ✓ | ✓ | ✓ | ✓ | – | ✓ |
| Periodically during operation, page 91 | ✓ | – | – | – | ✓ | ✓ | ✓ | ✓ | ✓ | ✓ | ✓ |
| After carrying out work on the switchboard | – | – | ✓ | ✓ | ✓ | ✓ | ✓ | ✓ | ✓ | ✓ | ✓ |
| Periodically during lengthy downtime | – | – | ✓ | – | ✓ | ✓ | – | ✓ | ✓ | – | ✓ |
| After lengthy downtime | – | – | ✓ | – | ✓ | ✓ | ✓ | ✓ | ✓ | ✓ | ✓ |
| After lengthy downtime and modification to the switchboard | ✓ | ✓ | ✓ | ✓ | ✓ | ✓ | ✓ | ✓ | ✓ | ✓ | ✓ |
| <p>A Insulation and dielectric strength tests</p> <p>B Carry out temperature rise tests</p> <p>C Inspect switchboard</p> <p>D Check compliance with the diagram</p> <p>E Inspect mechanical equipment</p> <p>F Check connections</p> <p>G Check mechanical operation</p> <p>H Check auxiliary contacts on devices</p> <p>I Check earth-leakage protection (for earth-leakage circuit breaker only)</p> <p>J Check pairing of the wireless devices with gateway or panel server</p> <p>K Clean equipment</p> | | | | | | | | | | | |

A: Insulation Tests and Dielectric Strength Tests

DANGER

HAZARD OF ELECTRIC SHOCK, EXPLOSION, OR ARC FLASH

- Apply appropriate personal protective equipment (PPE) and follow safe electrical work practices.
- Insulation and dielectric strength tests must only be carried out by qualified electrical personnel.
- Disconnect all power sources before performing maintenance inspections. Assume that all circuits are live until they are de-energized, tested, grounded, and tagged. Consider all sources of power, including the possibility of backfeeding and control power.
- Always use a properly rated voltage sensing device to confirm that power is off.
- Replace all devices, doors, and covers before turning on power to this equipment.
- The protective cover for the connections must be reconnected without fail following dielectric tests.

Failure to follow these instructions will result in death or serious injury.

Insulation and dielectric strength tests are carried out before the switchboard is delivered. These tests are subject to the currently applicable standards.

Dielectric strength tests impose great stress on the equipment and can cause damage if performed incorrectly. In particular:

- Reduce the value used for the test voltage according to the number of consecutive tests on the same piece of equipment.
- Disconnect electronic equipment if necessary.

For earth-leakage circuit breakers (ELCB):

NOTICE

HAZARD OF TRIP UNIT DETERIORATION

- Turn the dielectric switch to the **Test** position (horizontal) when performing a dielectric test.
- Turn the switch back to the original position after the dielectric test.
- Do not close the protective cover during the dielectric test.

Failure to follow these instructions can result in equipment damage.

To perform a dielectric test for earth-leakage circuit breaker, do the following procedure:

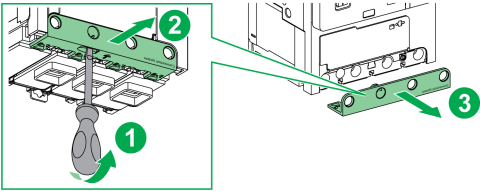
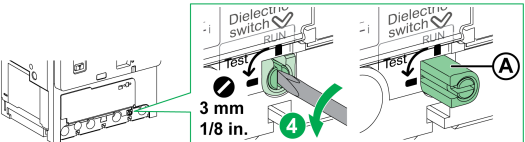
| Step | Action | |
|------|---|--|
| 1 | Unclip the green protective cover at the bottom front face of the earth-leakage circuit breaker: Push the tip of the screwdriver to the back to release the clip. |  |
| 2 | Remove the protective cover. | |
| 3 | Put the protective cover on one side. | |
| 4 | Turn the dielectric switch (A) counterclockwise from the RUN position (vertical) to the Test position (horizontal) by using a flat screwdriver. |  |

| Step | Action | |
|------|--|---|
| | Result: The switch pops out when the screwdriver is removed. | |
| 5 | After carrying out a dielectric test, push in the switch... | |
| 6 | ... and turn it clockwise from the Test position to the RUN position (vertical). Result: The dial stays pushed in (B) when the screwdriver is removed. | |
| 7 | Clip the green protective cover back into place. | |
| 8 | After performing the dielectric test, carry out an earth-leakage test, page 21. | — |

⚠ WARNING

LOSS OF EARTH-LEAKAGE PROTECTION

The dielectric switch must be in the retracted position while the circuit breaker is in use.

Failure to follow these instructions can result in death, serious injury, or equipment damage.

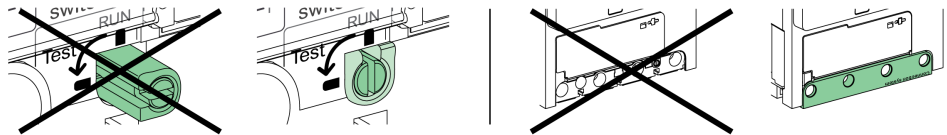

A: Insulation Tests and Dielectric Strength Tests with PowerTag Energy F160

NOTICE

HAZARD OF POWERTAG ENERGY F160 DETERIORATION

- Disconnect the voltage take-offs of the PowerTag Energy F160 before performing the dielectric withstand test or insulation measurements.
- Connect the voltage take-offs of the PowerTag Energy F160 after the dielectric test.

Failure to follow these instructions can result in equipment damage.

PowerTag Energy F160 is an electronic device which needs to be disconnected before dielectric tests. Follow this procedure before carrying out a dielectric test:

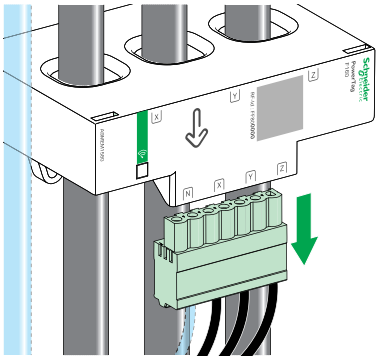
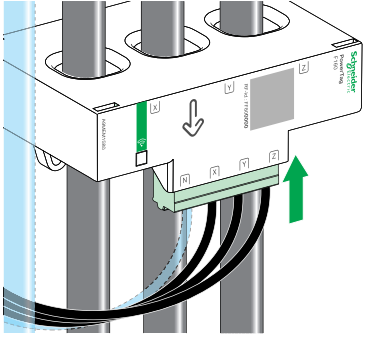
| Step | Action | |
|------|--|--|
| 1 | Disconnect the voltage take-offs of the PowerTag Energy F160. |  |
| 2 | Carry out the dielectric test, as described, page 86. | — |
| 3 | Connect the voltage take-offs of the PowerTag Energy F160 after the dielectric test. |  |

B: Temperature Rise Tests

Temperature rise tests are carried out before the switchboard is delivered. ComPacT NSXm circuit breakers comply with product standards IEC/EN 60947-1 and IEC/EN 60947-2.

For general-purpose systems, tests are carried out at an ambient temperature of 40 °C (104 °F). Above 40 °C (104 °F), thermal protection characteristics are slightly modified and the values defined in the derating tables must be taken into account. These values are valid for circuit breakers with or without terminal shields.

C: Inspect Switchboard

Check that the circuit breakers are installed:

- In a clean environment, without waste from assembling the equipment (such as wiring, tools, shavings, metallic particles).
- In a properly ventilated switchboard (unobstructed ventilation grills).

D: Check Compliance with the Diagram

Check that the circuit breakers comply with the installation diagram:

- Identification of the feeds on the front of the circuit breakers
- Rating and breaking capacity (indications on the faceplate label)
- Identification of the trip units (type, rating)
- Presence of additional functions (rotary handle, control or indication auxiliaries, locking, sealing)

- Protection settings (overload, short-circuit, earth-leakage): visually check the position of the adjustment dials on the trip unit

E: Inspect Mechanical Equipment

Visually inspect the general state of the circuit breaker. Check the following items:

- Terminal shields and interphase barriers
- Trip unit
- Case

Check the equipment integrity: a circuit breaker found with a cracked case or burn marks must be immediately taken out of service and replaced.

Check the mounting and mechanical strength:

- Of circuit breakers in the switchboard.
- Of auxiliaries and accessories on the circuit breakers:
 - Rotary handles or motor mechanisms
 - Installation accessories (such as terminal shields)
- Of locks, padlocks and padlock support tabs

F: Check Connections

Check the tightening torque of the power connections and auxiliary circuit connections, as described in the instruction sheets.

G: Check Mechanical Operation

Check the mechanical operation of the circuit breaker:

- Opening, closing and resetting
- Tripping with the push-to-trip button
- Tripping by MN/MX control auxiliaries

H: Check Auxiliary Contacts on Devices

Check that the following are working correctly:

- OF and SD indication contacts
- SDx modules
- Wireless indication auxiliaries

I: Check Earth-Leakage Protection (For Earth-Leakage Circuit Breaker Only)

Check that the earth-leakage protection is working correctly by operating the test button T on the front, page 21. This test checks the whole measurement system and tripping on earth-leakage faults.

J: Check Pairing of Wireless Devices with Gateway or Panel Server

Check that wireless communication with gateway or panel server is working correctly:

- For PowerTag Energy F160, page 80, LED is blinking green each time data is sent (every 5 seconds by default)
- For wireless indication auxiliaries, page 71, LED is blinking green each time data is sent (every 8 hours, or when status changes).

K: Clean Equipment

To reduce dust deposits that can affect the mechanical operation of circuit breakers, clean the circuit breakers when performing maintenance:

- Non-metallic parts: Always use a dry cloth. Do not use cleaning products.
- Metallic parts: Preferably use a dry cloth. If a cleaning product is used, do not apply or splash the cleaning product on non-metallic parts.

Maintaining the Circuit Breaker During Operation

Introduction

The electrical switchboard and all its equipment continue to age whether they operate or not. This aging process is due mainly to environmental influences and operating conditions.

To help ensure that circuit breaker retains the operating and safety characteristics specified in the catalogue for the whole of its service life:

- Install the circuit breaker in optimum environmental and operating conditions (described in the following table).
- Have routine inspections and regular maintenance done by qualified electrical personnel.

Environmental and Operating Conditions

The environmental conditions previously described, page 24 refer to harsh operating environments.

The following table describes the optimum environmental and operating conditions.

| Environmental and operating factor | Comments |
|---|---|
| Temperature | Average annual temperature outside the switchboard: < 25 °C (77 °F). |
| Loading | Loading remains < 80% of In for 24 hours a day. |
| Harmonics | The harmonic current per phase is < 30% of In. |
| Humidity | The relative humidity is < 70%. |
| Corrosive atmosphere (SO ₂ , NH ₃ , H ₂ S, Cl ₂ , NO ₂) | Install the circuit breaker in environmental category 3C1 or 3C2 (IEC/ EN 60721-3-3). |
| Saline environment | Install the circuit breaker in an environment free of salt mist. |
| Dust | The dust level is low: protect the circuit breaker within a switchboard fitted with filters or IP54 ventilated. |
| Vibration | Continuous vibration is < 0.2 g. |

The maintenance programs apply to optimum environmental and operating conditions. Outside these limits, circuit breakers are subject to accelerated aging, which can quickly lead to problems.

Regular Preventive Maintenance

Maintenance recommendations for each device are intended to maintain the equipment or subassemblies in a satisfactory operational state for their useful service life.

There are three recommended maintenance levels.

The following table summarizes maintenance operations for the three preventive maintenance programs:

| Maintenance program | Maintenance description | Performed by |
|-------------------------------|---|--|
| Basic end-user maintenance | Visual inspection and functional testing, replacement of inoperative accessories. | <ul style="list-style-type: none"> Trained and qualified end-user personnel Trained and qualified maintenance services provider personnel Schneider Electric field service representative |
| Standard end-user maintenance | Basic end-user maintenance, plus operational servicing and subassembly tests. | <ul style="list-style-type: none"> Trained and qualified maintenance services provider personnel Schneider Electric field service representative |
| Manufacturer maintenance | Standard end-user maintenance, plus diagnostics and part replacements by Schneider Electric Services. | Schneider Electric field service representative |

If all environmental conditions are more favorable than normal, maintenance intervals can be longer than the ones in normal environmental and operating conditions (for example, Advanced level tasks can be carried out every 3 years).

If any one of the conditions is more severe, perform maintenance more frequently. For advice, contact Schneider Electric Services.

Functions linked specifically to safety require particular maintenance intervals.

NOTE: Regularly test that the remote safety commands work. For example, test at least every six months.

Maintenance Operations Required

| |
|--|
| ⚠ CAUTION |
| HAZARD OF EQUIPMENT DAMAGE |
| Insulation and dielectric strength tests must only be carried out by qualified electrical personnel. |
| Failure to follow these instructions can result in injury or equipment damage. |

Maintenance operation mainly consists of checks and inspections A, E, F, G, H, I, J, and K as defined for the commissioning phase, page 85.

| Letter - maintenance operation | Maintenance operation | Year 1 | Year 2 | Year 3 | Year 4 | Year 5 |
|--------------------------------|--|--------|--------|--------|--------|--------|
| A | Insulation and dielectric strength tests, page 86 | ✓ | ✓ | ✓ | ✓ | ✓ |
| E | Inspect mechanical equipment, page 89 | ✓ | ✓ | ✓ | ✓ | ✓ |
| F | Check connections, page 89 | ✓ | ✓ | ✓ | ✓ | ✓ |
| – | Measurement of insulation resistance | ✓ | ✓ | ✓ | ✓ | ✓ |
| G | Check mechanical operation, page 89 NOTE: Check tripping by MN/MX twice a year | ✓ | ✓ | ✓ | ✓ | ✓ |
| – | Replace MN/MX trip releases | – | – | – | – | ✓ |
| H | Check auxiliary contacts, page 89 | ✓ | ✓ | ✓ | ✓ | ✓ |

| Letter - maintenance operation | Maintenance operation | Year 1 | Year 2 | Year 3 | Year 4 | Year 5 |
|--------------------------------|--|--------|--------|--------|--------|--------|
| I | I Check earth-leakage protection, page 89 (for earth-leakage circuit breaker only) | ✓ | ✓ | ✓ | ✓ | ✓ |
| J | J Check pairing of the wireless devices with gateway or panel server, page 90 | ✓ | ✓ | ✓ | ✓ | ✓ |
| – | Check the closing time, opening time and voltage release characteristics | ✓ | ✓ | ✓ | ✓ | ✓ |
| K | Clean equipment, page 90 | ✓ | ✓ | ✓ | ✓ | ✓ |

For detailed definition of the maintenance operations, contact Schneider Electric Services.

Maintenance Following Short-Circuit Trip

Test a circuit breaker in severe conditions, in accordance with standard IEC/EN 60947-2, to check that it can break a short-circuit current at maximum permissible value three times.

After a short-circuit fault, it is necessary to:

- Carefully clean off any traces of black smoke. The smoke particles can conduct electricity.
- Check the power connections and control wires.
- Operate the circuit breaker at least five times at zero load.

Responding to a Trip

Taking Precautions Before Responding to a Trip

⚡ ⚠ DANGER

HAZARD OF ELECTRIC SHOCK, EXPLOSION, OR ARC FLASH

- Apply appropriate personal protective equipment (PPE) and follow safe electrical work practices. See NFPA 70E, CSA Z462, NOM-029-STPS, or local equivalent.
- This equipment must only be installed and serviced by qualified electrical personnel.
- Turn off all power supplying this equipment before working on or inside equipment.
- Always use a properly rated voltage sensing device to confirm that power is off.
- Replace all devices, doors, and covers before turning on power to this equipment.
- Beware of potential hazards, and carefully inspect the work area for tools and objects that may have been left inside the equipment.

Failure to follow these instructions will result in death or serious injury.

Before inspecting electrical equipment downstream of the circuit breaker, always isolate the feed.

Identifying the Cause of the Trip

A trip can be caused by the following events:

- Fault detected on the installation
- Fault detected caused by a malfunction
- Intentional tripping

Check the circuit breaker and the electrical installation to find the root cause of the trip.

Checking Equipment After a Trip

⚠ WARNING

HAZARD OF CLOSING ON ELECTRICAL FAULT

Do not close the circuit breaker again without first inspecting and, if necessary, repairing the downstream electrical equipment.

Failure to follow these instructions can result in death, serious injury, or equipment damage.

NOTE: Checks, tests, and inspections must be carried out by qualified electrical personnel.

The fact that the protection has tripped does not remedy the cause of the fault detected on the downstream equipment.

Perform the following tasks after a short-circuit:

- Carefully clean off any traces of black smoke. The smoke particles can conduct electricity.
- Check the power connections and control wires.
- Operate the circuit breaker at least five times at zero load.

Depending on the type of fault detected, perform the following inspections, page 85 on all or part of the equipment where the fault occurred:

- For faults tripped by thermal protection:
 - Check the system for damage, and then repair if necessary.
 - Perform checks E and G.
- For faults tripped by magnetic protection or caused by an unknown reason:
 - Check the system for damage, and then repair if necessary.
 - Perform checks A, E, and G.
- For faults tripped by earth-leakage protection:
 - Check the system for damage, and then repair if necessary.
 - Perform checks E, G, and I.

Resetting the Circuit Breaker

Before resetting the circuit breaker, make sure that the fault is identified and repaired, and that the installation has been checked.

If the system must be restarted quickly (for example, in a safety installation), isolate and lock out the affected part of the installation before carrying out maintenance.

The procedure for resetting a circuit breaker depends on the type of handle on the circuit breaker, page 34.

Troubleshooting

Introduction

Troubleshooting operations are described in the following tables, with the checks or repairs to be carried out in relation to the probable causes of the malfunction indicated. They are classified into the following events:

- Repetitive tripping
- Circuit breaker fails to close

Repetitive Tripping

| Indication | Probable cause | Checks or repairs |
|------------|--|--|
| SD | Supply voltage to the MX undervoltage trip release is too low or subject to significant variations | Check the power supply for the release (for example, a supply powering motors with high-power ratings may be unstable). If so, connect the release to a clean or stable supply. |
| | Supply voltage to an MXshunt trip release applied unintentionally. | Check that the release connection is correct compared to the installation diagram. |
| SD | Operating temperature too high. | Check the switchboard ventilation and the temperature in the room. |
| SDV | Inappropriate earth-leakage protection setting. | Check the value of the natural leakage current. Depending on the results: <ul style="list-style-type: none"> • Isolate the equipment which had excessive natural leakage current • Or raise the earth-leakage protection setting, observing the safety rules. |
| | Transient ground fault on the equipment. | Check whether the fault coincides with commissioning an item of equipment. Depending on the results: <ul style="list-style-type: none"> • Repair the equipment causing the fault. • Isolate the equipment with excessive natural leakage current. • Or raise the earth-leakage protection setting, observing the safety rules. |

Circuit Breaker Fails to Close

| Indication | Probable cause | Checks or repairs |
|------------|---|--|
| SD | MX shunt trip release energized. MN undervoltage trip release not energized. | Check that the release connection is correct compared to the installation diagram. |
| OF | Circuit breaker interlocked | Check the installation and interlock diagram (mechanical or electrical) for both circuit breakers. |

Appendices

What's in This Part

| | |
|-----------------------|----|
| Wiring Diagrams | 98 |
|-----------------------|----|

Wiring Diagrams

What's in This Chapter

Circuit Breakers98

Circuit Breakers

Introduction

The diagrams are shown with circuits de-energized, all devices open, connected, and charged, and relays in normal position.

Terminals shown in red  must be connected by the customer.

Indication Contacts

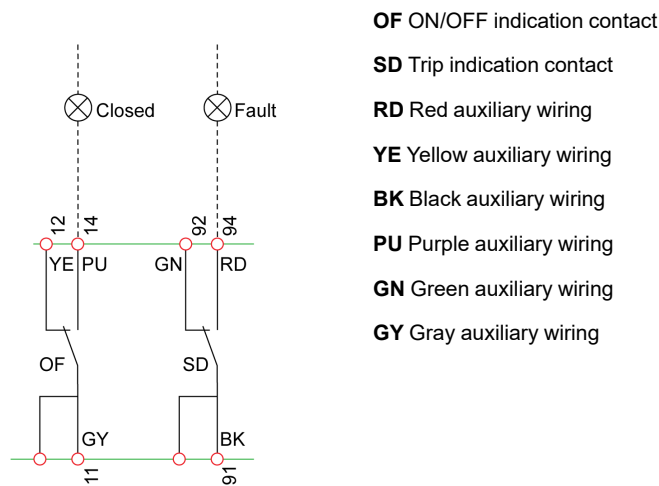

Remote Operation

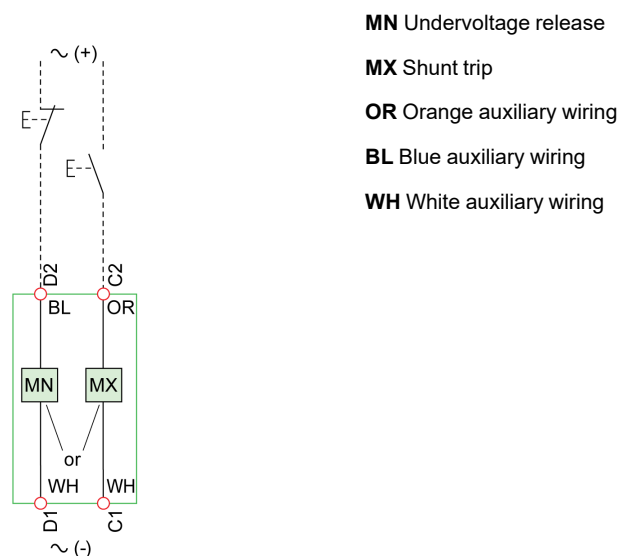

SDx Module

SDx SDx module

I1, I2 Digital inputs

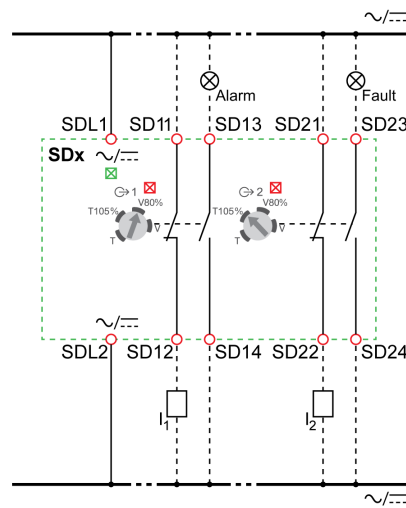

Index

A

| | |
|-------------------------|-------|
| accessory devices | 66 |
| auxiliaries | |
| voltage releases..... | 75 |
| auxiliary contacts | |
| operation | 70 |
| auxiliary devices..... | 66 |
| auxiliary slots | 67–68 |

C

| | |
|-------------------------------------|----------------|
| checks | |
| commissioning..... | 85 |
| maintenance..... | 91 |
| circuit breakers | |
| auxiliary slots..... | 67 |
| close | 38, 45 |
| commissioning..... | 85 |
| commissioning and maintenance | 84 |
| description..... | 10 |
| features..... | 9 |
| locking | 41 |
| maintenance..... | 91 |
| open | 38, 45 |
| reset | 46, 54 |
| testing | 40, 47, 55, 62 |
| toggle handle..... | 36 |
| close | 38, 45 |
| front extended rotary handle | 53 |

E

| | |
|--------------------------------|----|
| earth-leakage circuit breakers | |
| auxiliary slots..... | 68 |
| description..... | 11 |
| trip unit..... | 15 |
| electrical accessories | 27 |

I

| | |
|------------------------------|-------|
| indication contacts | |
| auxiliary slots..... | 67–68 |
| operation | 70 |
| insulation accessories..... | 27 |
| insulation requirements..... | 27 |

L

| | |
|------------------------|----|
| locking | |
| circuit breakers | 41 |

M

| | |
|---|--------|
| MN | |
| undervoltage release..... | 67, 75 |
| undervoltage release with time-delay unit | 67 |
| MX | |
| shunt trip | 67, 75 |

O

OF

| | |
|---------------------------------------|--------|
| indication auxiliary..... | 67 |
| open / close indication contact | 69 |
| open..... | 38, 45 |

P

| | |
|------------------------------|----|
| PowerTag Energy F160 | 80 |
| protection | |
| magnetic | 23 |
| thermal-magnetic (TM-D)..... | 14 |
| trip unit..... | 15 |

R

| | |
|------------|--------|
| reset..... | 46, 54 |
|------------|--------|

S

| | |
|------------------------------|----|
| SD | |
| indication auxiliary..... | 67 |
| trip indication contact..... | 69 |
| SDx module | 76 |
| sealing accessories | 13 |

T

| | |
|------------------------|----------------|
| testing | |
| circuit breakers | 40, 47, 55, 62 |
| trip mechanism | 40, 47, 55, 62 |
| trip mechanism | |
| testing..... | 40, 47, 55, 62 |

V

| | |
|------------------------|----|
| voltage releases | 75 |
|------------------------|----|

W

| | |
|-------------------------------------|----|
| wireless indication auxiliary | 71 |
|-------------------------------------|----|

Schneider Electric
35 rue Joseph Monier
92500 Rueil Malmaison
France

+ 33 (0) 1 41 29 70 00

www.se.com

As standards, specifications, and design change from time to time,
please ask for confirmation of the information given in this publication.

© Year of first release – Schneider Electric. All rights reserved.

DOCA0185EN-00