

This pack enables you to centralise a roller shutter in your home.

Pack contents

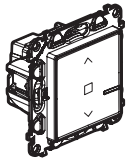

Pre-paired roller shutter switch

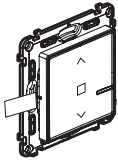

Pre-paired roller shutter wireless switch

⚠ This product only controls Valena Life with Netatmo roller shutter switches.

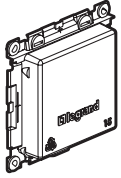

Site protection

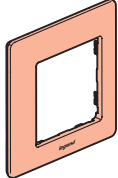

Finishing plate

x 2

x 4

Removable stickers

Characteristics

 +45°C +5°C 100-240 VAC 50/60 Hz	 1 x 2,5 mm ² 2 x 1,5 mm ²	 ① Roller shutter motor
100 VAC max.	1 x 270 VA	

⚠ Safety instructions

This product should be installed in compliance with installation rules, preferably by a qualified electrician. Incorrect installation and/or incorrect use can lead to risk of electric shock or fire. Before carrying out the installation, read the instructions and take account of the product's specific mounting location. Do not open up, dismantle, alter or modify the device except where specifically required to do so by the instructions. All Legrand products must be opened and repaired exclusively by personnel trained and approved by Legrand. Any unauthorised opening or repair completely cancels all liabilities and the rights to replacement and guarantees. Use only Legrand brand accessories.

LE10947AA

Before you start

To centralise your roller shutter switches with one or more wireless switches, only use the following products:

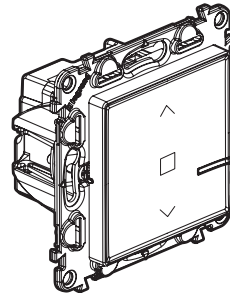

Roller shutter switches
(one switch included in this pack)

AND
x 1
or several

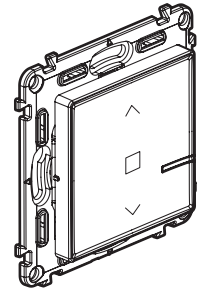

Roller shutter wireless switches
(one wireless switch included in this pack)

x 1
or several

⚠ This pack only works with roller shutter switches and roller shutter wireless switches.

① Necessary safety precautions



OFF
Switch off the power at the main circuit breaker.

2

⚠ Make sure that the power is off before continuing with the installation.

② Install the roller shutter switch

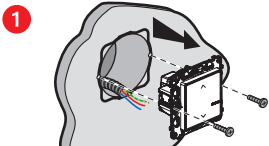

Remove the existing switch.

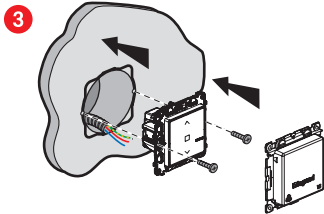

② Wire the roller shutter switch.

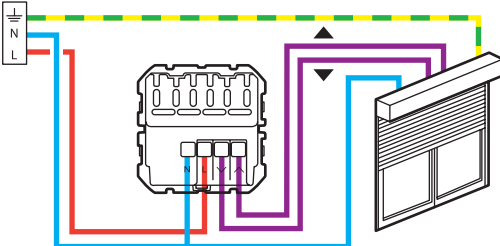

The roller shutter switch is compatible with roller shutters with a mechanical or electronic stop, controlled by a standard roller shutter wired switch. It is not compatible with motors directly controlled by radio control. To check this, refer to the roller shutter instructions.

Frequency bands: 2.4 - 2.4835 GHz
Power level: < 100 mW
— N (neutral) = blue
— L (live) = any except blue and green/yellow
— ⊕ (earth) = green/yellow

③ Power up the roller shutter switch



Mandatory installation step:

1



Turn the power back on at the main circuit breaker.

ON

② The indicator light on the roller shutter switch flashes orange.

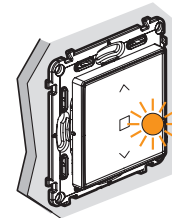

4 Install the wireless switch included in this pack

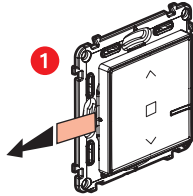

Take the wireless switch **included in this pack**. Remove the protective strip from the battery to power up the switch.

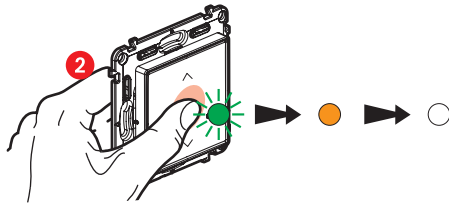

Press the wireless switch **briefly** to activate it. The indicator light will flash green and then turn permanently orange, then switch off.

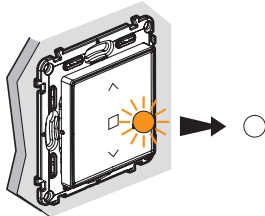

The indicator light on the **roller shutter wired switch** supplied in the pack goes off. **The centralised control system of your roller shutter is now functional.**

5

If you want to add one or more wireless switches, go straight to step 8.

5 You want to add one or more roller shutters switches.

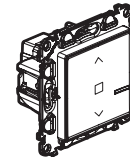

Wire the roller shutter switches using the individual user instructions provided in the packaging for each of them.

6 Power the wired products



Turn the power back on at the main circuit breaker.

You must power all the wired products simultaneously.

2 The indicator lights on the additional wired products light up a continuous red. Only the indicator light on the roller shutter switch supplied in the pack stays off.

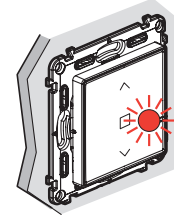

6

7 Start setting up the additional wired products

1 Press the button of the wireless switch already installed (it is included in the initial pack) in the centre, until its light briefly shines orange, **then release**.

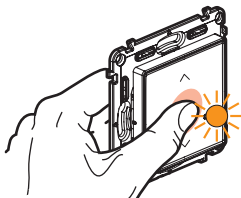

2 The indicator lights on the all products you have wired turn permanently orange one by one.

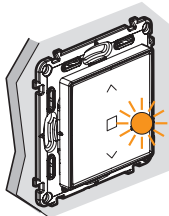

3 Complete the setup.

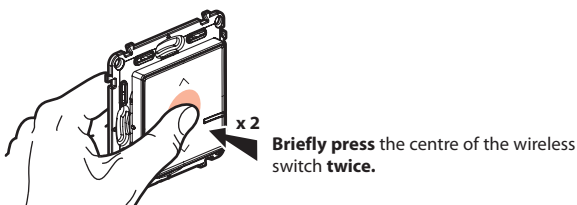

All the indicator lights on the products switch off.

Your wireless switch now controls all your wired products.

7

8 Install any additional wireless switches:

1 Press the button of the wireless switch already installed (it is included in the initial pack) in the centre, until its light briefly shines orange, **then release**.

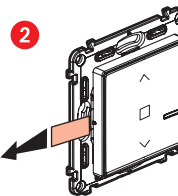
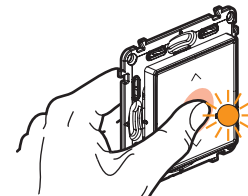

Remove the protective strips from each of the wireless switches.

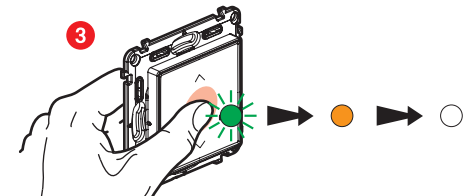

Briefly press each of the wireless switches to activate them. The indicator lights will flash green then light up permanently orange and then switch off.

4 Complete the setup.

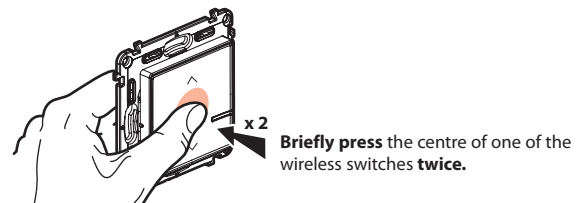

All the indicator lights on the products switch off.

The centralised control system is now functional. Any one of your wireless switches now controls all your wired products.

8

9 Attach the wireless switches

Attach the wireless switch(es) in the required places.

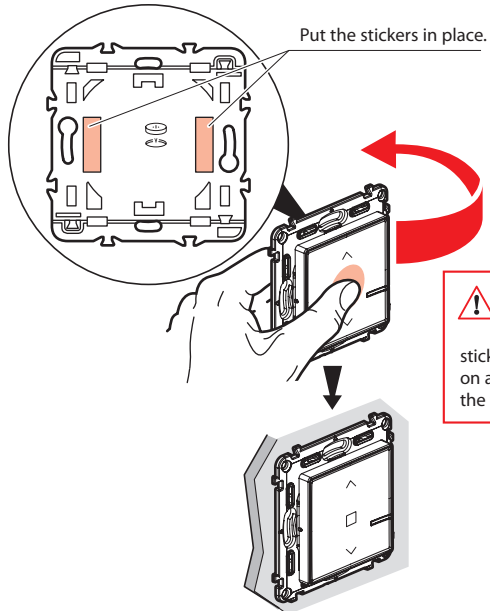

Put the stickers in place.

⚠ Before you attach the wireless switch(es) with the removable stickers provided, test one on a non-visible part of the wall.

You can also attach the wireless switch(es) permanently to the wall with screws.

10 Install the finishing plates

Install the finishing plates on all of the products installed.

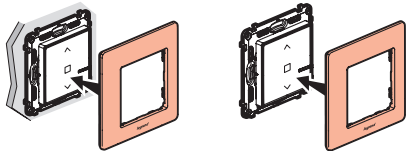

www.legrand.fr

LEGRAND - Pro and Consumer Service - BP 30076
87002 LIMOGES CEDEX FRANCE • www.legrand.com

Replacing the battery of a wireless switch

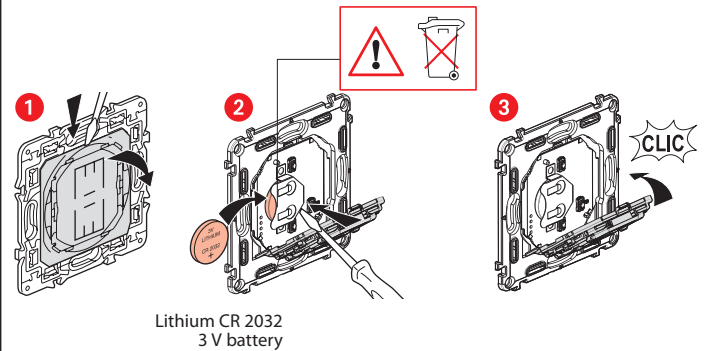

Lithium CR 2032
3 V battery

SIMPLIFIED EU DECLARATION OF CONFORMITY

The undersigned,

Legrand

declares that the radio-electric equipment referred to in these instructions complies with directive 2014/53/EU. The full text of the EU declaration of conformity is available

on the following website:

www.legrandoc.com