

This pack enables you to create a 2-way switch in your home. You can complete this pack with the compatible products in Valena Life with Netatmo range: **power outlets, light switches, lighting micromodules and wireless light switches** sold separately.

### Pack contents

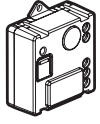

Pre-paired lighting micromodule

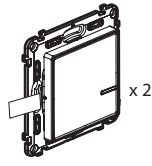

Pre-paired wireless light switch

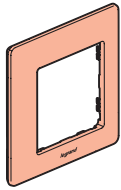

x 2

Finishing plate



x 8

Removable stickers

### ⚠ Safety instructions

This product should be installed in compliance with installation rules, preferably by a qualified electrician. Incorrect installation and/or incorrect use can lead to risk of electric shock or fire. Before carrying out the installation, read the instructions and take account of the product's specific mounting location. Do not open up, dismantle, alter or modify the device except where specifically required to do so by the instructions. All **Legrand** products must be opened and repaired exclusively by personnel trained and approved by **Legrand**. Any unauthorised opening or repair completely cancels all liabilities and the rights to replacement and guarantees. Use only **Legrand** brand accessories.

LET0948AA

### Before you start: wiring precautions

To install or replace a remote switch, only use the following product:

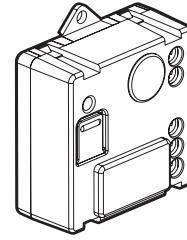

x 1

Lighting micromodule

You can keep the existing push buttons or replace them with wireless switches.

### Characteristics

In default mode (on/off), this switch works with the following types of bulb :

		R		L		
+45°C +5°C			<b>LED</b>			
100-240 VAC	1 x 1.5 mm <sup>2</sup>	300 W	(*)100 W	250 VA	250 VA	250 VA
50/60 Hz		150 W	(**)50 W	125 VA	125 VA	125 VA
240 VAC	Max.					
100 VAC	Max.					

(\*) or 10 bulbs max. For comfortable lighting, we recommend using bulbs of the same type and make.

(\*\*) Use only transformers intended for operation with electronic switches. Take account of transformer losses for power calculations. Transformers should be charge to over 60% of their rated power

2

### 1 Necessary safety precautions



Switch off the power at the main circuit breaker.

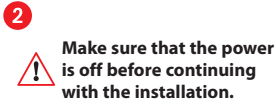

Make sure that the power is off before continuing with the installation.

### 2 Install the lighting micromodule

The lighting micromodule in the Valena Life with Netatmo range must be installed in a ceiling light or in wall lights.

#### 1 Wire the lighting micromodule.

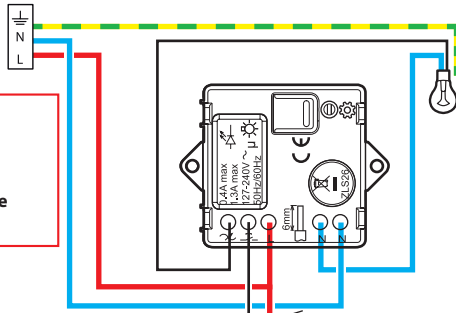

⚠ Make sure that the power is off before continuing with the installation.

⚠ Max. 15 m  
⚠ x 5 Max.

Option: Wiring a non-illuminated mechanical pushbutton to be used as a remote control.

Frequency bands: 2.4 - 2.4835 GHz  
Power level: < 100 mW

— N (neutral) = blue  
— L (live) = any except blue and green/yellow  
— ⚡ (earth) = green/yellow

3

### 3 Power up the micromodule

⚠ **Mandatory installation step:**



Turn the power back on at the main circuit breaker.

#### 2 The indicator light on the micromodule flashes orange.

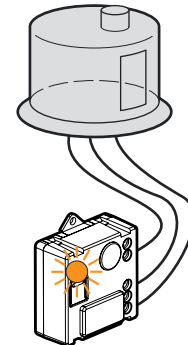

4

**4 You must install the two wireless switches included in the pack**

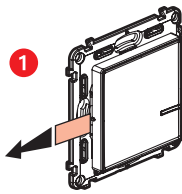

Take the two wireless switches included in this pack. Remove the protective strip from the battery to power up the switches.

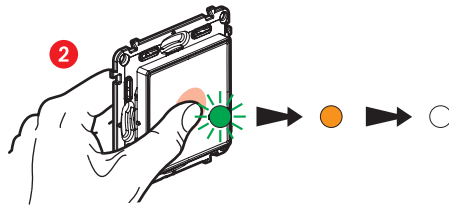

Press the wireless switches **briefly** to activate them. The indicator lights will flash green and then turn permanently orange, then switch off.

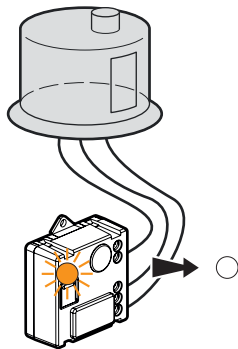

The light on the **micromodule** supplied in the pack goes off.  
**The 2-way switch is now functional.**

5

If you want to add one or more wireless switches, go straight to step 8.

**5 You want to add one or more wired products**

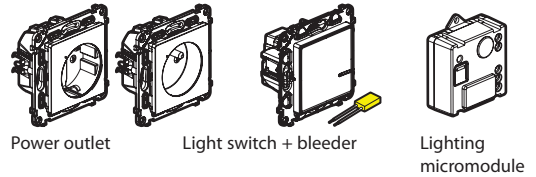

Wire the wired products using the individual user instructions provided in the packaging for each of them.

**6 Power the wired products**



Turn the power back on at the main circuit breaker.

**You must power all the wired products simultaneously.**

**2** The indicator lights on the additional wired products light up a continuous red. Only the indicator light on the micromodule supplied in the pack stays off.

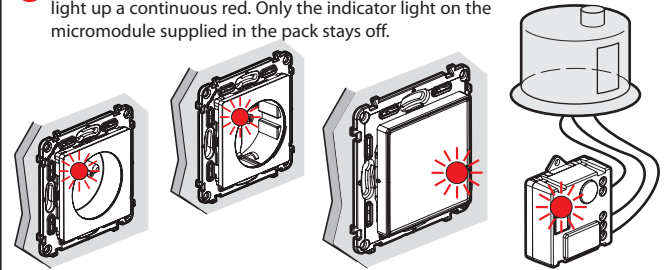

6

**7 Start setting up the additional wired products**

**1** Press the button of one of the two wireless switches already installed (included in the initial pack) in the centre, until the indicator light briefly shines orange, then release.

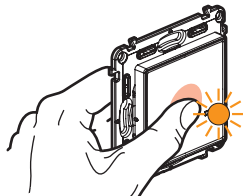

**2** The indicator lights on the all products you have wired turn permanently orange one by one.

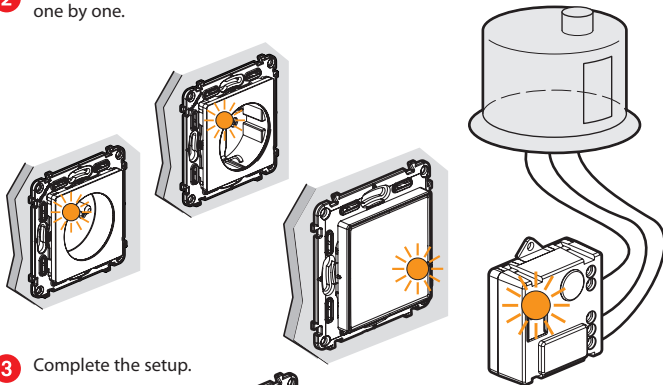

**3** Complete the setup.

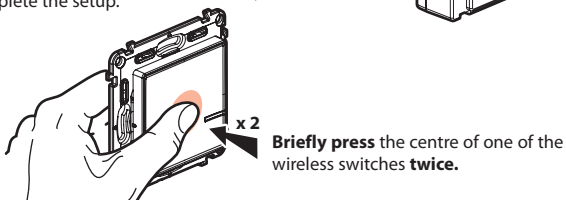

**All the indicator lights on the products switch off.**

The centralised control system is now functional. Any one of your wireless switches now controls all your wired products.

7

**8 Install any additional wireless switches:**

**1** Press the button of one of the two wireless switches already installed (included in the initial pack) in the centre, until the indicator light briefly shines orange, then release.

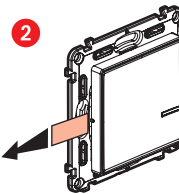
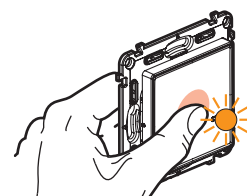

Remove the protective strips from each of the wireless switches.

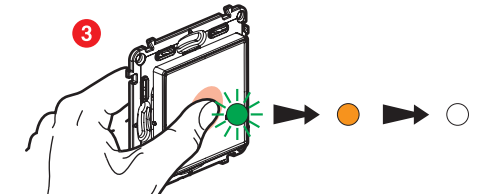

**Briefly** press each of the wireless switches to activate them. The indicator lights will flash green then light up permanently orange and then switch off.

**4** Complete the setup.

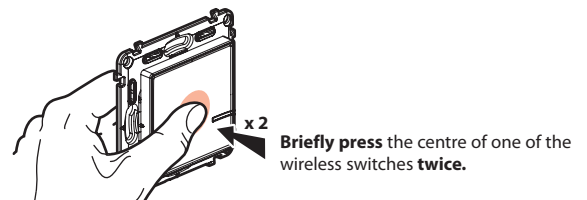

**All the indicator lights on the products switch off.**

The centralised control system is now functional. Any one of your wireless switches now controls all your wired products.

8

## 9 Attach the wireless switches

Attach the wireless switch(es) in the required places.

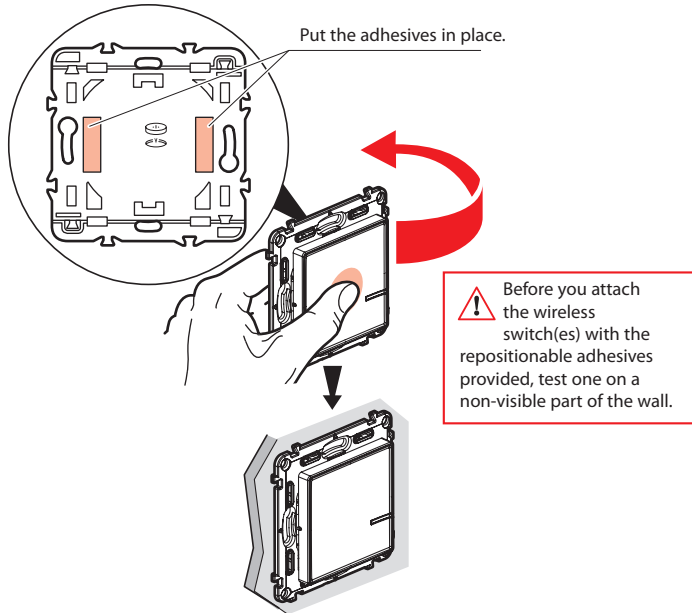

You can also attach the wireless switch(es) permanently to the wall with screws.

## 10 Install the finishing plates

Install the finishing plates on all of the products installed.

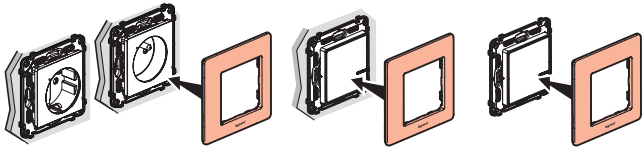

9



[www.legrand.fr](http://www.legrand.fr)

LEGRAND - Pro and Consumer Service - BP 30076  
87002 LIMOGES CEDEX FRANCE • [www.legrand.com](http://www.legrand.com)

## Replacing the battery of a wireless switch

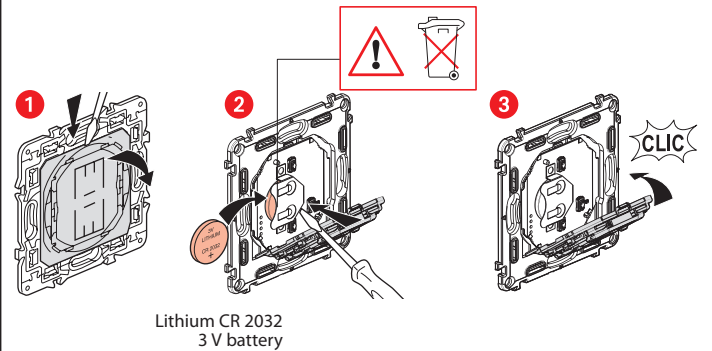

## SIMPLIFIED EU DECLARATION OF CONFORMITY

The undersigned,

**Legrand**

declares that the radio-electric equipment referred to in these instructions complies with directive 2014/53/EU. The full text of the EU declaration of conformity is available on the following website:

[www.legrandoc.com](http://www.legrandoc.com)