

—  
INSTALLATION AND OPERATING INSTRUCTION

# Automatic transfer switches

## TruONE® ATS, OX\_ 30...1600\_





---

# Receiving, handling and storage



**Warning**

---

## **HAZARD OF EQUIPMENT OVERTURNING**

When moving with a fork lift, do not remove the shipping package until the device is in its final location.

**Failure to follow this instruction will result in personal injury or equipment damage.**

## **Receiving and handling**

Upon receipt, carefully inspect the switch for damage that may have occurred during transit. If damage is evident, or there is visible indication of rough handling, immediately file a damage claim with the transportation company, and notify your local ABB sales office.

Do not remove the shipping package until ready to install the switch.

## **Storage**

If the unit will not be placed into service immediately, store the switch on its original package in a clean, dry location. To prevent condensation, maintain a uniform temperature. Store the unit in a temperature controlled building, allowing adequate air circulation and protection from dirt and moisture. Storing the unit outdoors could cause harmful condensation inside the switch enclosure.

---

# Read these safety instructions carefully before using this product!

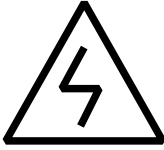

**Danger**

---

## **HAZARD OF ELECTRIC SHOCK, EXPLOSION, OR ARC FLASH**

- Wear appropriate personal protective equipment and follow safe electrical work practices.
- This equipment must only be installed and serviced by qualified electrical personnel.
- Disconnect all sources of electrical supply before performing visual inspections, tests, service or maintenance on the equipment. Assume that all circuits are live unless they are completely de-energized, tested, grounded, and tagged. Pay particular attention to the design of the power system. Consider all sources of power, including the possibility of backfeeding.
- Turn off switch before removing or making load side connections.
- Always use a properly rated voltage sensing device at all line and load to confirm switch is off.

**Failure to follow these instructions could result in death or serious injury.**



**General warning**

---

## **HI-POT OR DIELECTRIC TEST**

- Performing a hi-pot or dielectric test on the power section, REMOVE the mechanism from the switch.
- See details in Service Instruction manual.

---

# **Installation and operating instruction**

Automatic transfer  
switches, TruONE® ATS

**OPERATING INSTRUCTIONS,  
TRUONE® ATS, OX\_30...1600  
CHAPTERS 1-7**

**INSTALLATION INSTRUCTIONS,  
TRUONE® ATS, OX\_30...1600  
CHAPTERS 8-10**

1

2



---

# Operating instruction

## Automatic transfer switches, TruONE® ATS

<b>1. Introduction</b>	<b>11</b>
1.1 Use of symbols in manual	
1.2 Explanations of abbreviations and terms	
<b>2. Product overview</b>	<b>13</b>
2.1 General overview	14
2.1.1 Differences of level types / operation types and suitability of Ekip-modules	15
2.2 HMI	17
2.3 TruONE® ATS feature comparison	18
2.4 Typical applications	21
2.5 Description of basic functionality	23
2.5.1 Switching sequence / Automatic	23
2.5.2 Automatic configuration	29
2.5.3 In-phase monitor	29
2.5.4 Powering supply scenarios	29

<b>3. Operating</b>	<b>30</b>
3.1 Position indication	30
3.2 Operating and locking	31
3.3 Manual mode, operating by the handle	32
3.4 Automatic mode, operating by HMI	34
3.5 LED functionality in HMI	35
3.6 Using Level 2 (DIP) control interface HMI	37
3.6.1 Keypad	37
3.6.2 Configuration by DIP-switches	38
3.7 Using Level 3 (LCD) control interface HMI	40
3.7.1 Keypad	40
3.7.2 Navigating in menu	40
3.8 Using Level 4 (touch) control interface HMI	41
3.8.1 Keypad	41
3.8.2 Navigating in menu	41
<b>4. Navigating menu</b>	<b>42</b>
4.1 Level 3 (LCD) control interface, menu tree	42
4.1.1 Start screens	44
4.1.2 Enter key, main menu	45
4.1.3 Esc key	55
4.2 Level 4 (touch) control interface, menu tree	56
4.2.1 Start Menu	58

<b>5. Electronic accessories</b>	<b>73</b>
5.1 Using Ekip Connect -software	74
5.2 Using Ekip Bluetooth-module	75
5.2.1 Signallings	75
5.3 Using Ekip Programming -module	76
5.3.1 Signallings	76
5.4 Auxiliary power supply module	77
5.4.1 Electrical characteristics	77
5.4.2 Signallings	77
5.5 Using Ekip Signalling 2K_-module	78
5.5.1 Electrical characteristics of Ekip Signalling 2K_-module	78
5.5.2 Access from the display / Ekip Signalling 2K_-module	78
5.5.3 Signals and inputs/outputs of Ekip Signalling 2K_-module	81
5.6 Using Ekip Com_-modules	82
5.6.1 Ekip Com Modbus RTU -module	82
5.6.2 Ekip Com Profibus DP -module	85
5.6.3 Ekip Com DeviceNet -module	89
5.6.4 Ekip Com Modbus TCP -module	93
5.6.5 Ekip Com Profinet -module	97
5.6.6 Ekip Com EtherNet/IP -module	100
5.6.7 Ekip Com IEC 61850 -module	104
5.6.8 Ekip Com Hub -module	108

<b>6. Troubleshooting</b>	<b>112</b>
6.1 Alarms	112
6.2 Warnings	114
6.3 Information	115
<b>7. Technical data</b>	<b>116</b>
7.1 Circuit diagrams	119

# 1. Introduction

This manual describes the installation and the basic operation of the automatic transfer switches TruONE® ATS (OX\_30...1600\_), manufactured by ABB. Mounting instructions for the switch and for the available accessories see Part 2, chapters 8 and 9.

## 1.1 Use of symbols in manual



### **Hazardous voltage**

Warns about a situation where a hazardous voltage may cause physical injury to a person or damage to equipment.



### **General warning**

Warns about a situation where something other than electrical equipment may cause physical injury to a person or damage to equipment.



### **Caution**

Provides important information or warns about a situation that may have a detrimental effect on equipment.



### **Information**

Provides important information about the equipment.

## 1.2 Explanations of abbreviations and terms

### ATS

Automatic transfer switches

### Ekip

Electronic accessories / Ekip-modules; communication, signaling and connectivity modules

### HMI

Control interface (Human Machine Interface), operating and configuration, available in three different level types

### Level 2

HMI with DIP-switches

### Level 3

HMI with LCD-screen

### Level 4

HMI with touch screen and sensor module  
OXCT\_

### OX\_

Automatic transfer switches, type name

### OXA\_B

Automatic transfer switch, open transition I - II, SOURCE on bottom, type name

### OXA\_T

Automatic transfer switch, open transition I - II, SOURCE on top, type name

### AXB\_B

Automatic transfer switch, delayed transition I - O - II, SOURCE on bottom, type name

### AXB\_T

Automatic transfer switch, delayed transition II - O - I, SOURCE on top, type name

### Programming port

Only for Ekip Programming and Ekip Bluetooth -modules (USB port)

### Slide switch

Switch for operating mode selection (Hand - Locking - AUTO)

### S1

SOURCE 1, power supply

### S2

SOURCE 2, power supply

### TruONE® ATS

Automatic transfer switches, product name

---

## 2. Product overview

---

Automatic transfer switches TruONE® ATS (type OX\_), from 30 A up to 1600 A, are designed for use in emergency or standby systems to transfer a load automatically from one source to another. TruONE® ATS automatic transfer switches can be operated also electrically by DIP, LCD or Touch control interface (HMI) and manually by using the handle. Operating mode can be selected by the slide switch (Hand - Locking - AUTO) on switch front. Configuration is done by HMI. TruONE® ATS automatic transfer switches are suitable for low voltage automatic transfer switch applications.

The available operation types for automatic transfer switches:

- Automatic transfer switch TruONE® ATS, type OXA30...1600\_: Open transition
  - OXA30...1600\_B\_: I - II, sources on bottom, load on top
  - OXA30...1600\_T\_: II - I, sources on top, load on bottom
- Automatic transfer switch TruONE® ATS, type OXB30...1600\_: Delayed transition
  - OXB30...1600\_B\_: I - O - II, sources on bottom, load on top
  - OXB30...1600\_T\_: II - O - I, sources on top, load on bottom

## 2.1 General overview

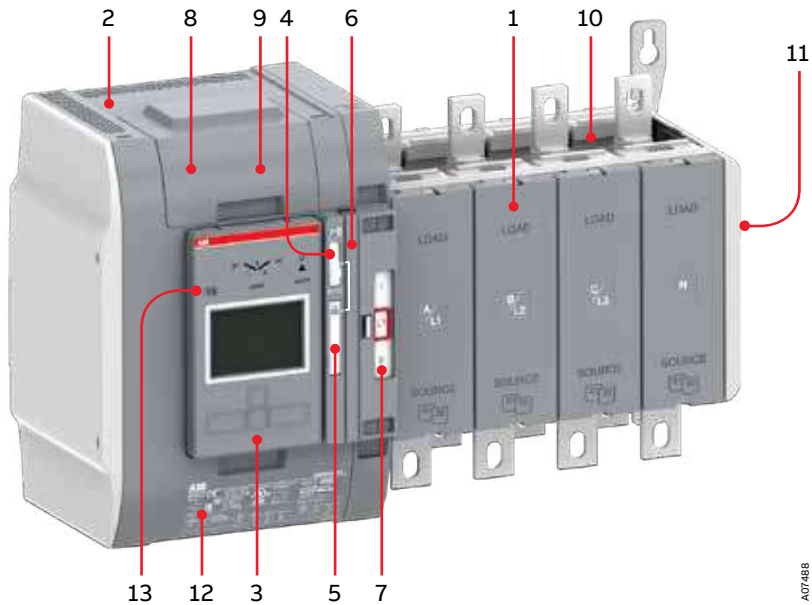

A07488



Fig. 2.1 Automatic transfer switch, TruONE® ATS, type OXB\_B

- 1 Transfer switch
- 2 Embedded ATS control unit and mechanism
- 3 Detachable HMI unit, three types of control interfaces Level 2 (DIP), Level 3 (LCD) and Level 4 (touch) for configuration and automatic operation
- 4 Slide switch (Hand - Locking - AUTO) for selection of the operation mode
- 5 Padlocking the automatic transfer switch to prevent automatic and manual operation. Note: Slide switch (Hand - Locking - AUTO) has to be in Locking-position
- 6 Handle for manual operation
- 7 Position indication
- 8 Terminals for control circuit connections (behind the cover)
- 9 Place for connectivity modules (aux power supply, communication and signaling)
- 10 Place for sensor module (included as standard with Level 4 controls)
- 11 Place for auxiliary contact blocks
- 12 Product identification label
- 13 Programming port, only for Ekip Programming and Ekip Bluetooth-modules

### 2.1.1 Differences of level types / operation types and suitability of Ekip-modules

In this table you can find the differences of the controller level types 2, 3 and 4 in the automatic transfer switch operation types of open and delayed transition. The differences are on HMI and on number of I/O contacts. For more information on HMIs, see chapter 2.2. For wiring, see chapter 7.

In addition you can find to which controller level types the Ekip connectivity modules mounted with auxiliary power supply module (see chapters 5.4 ...5.6) are suitable.



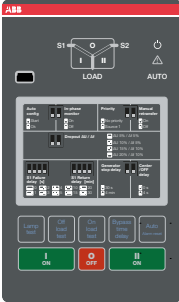
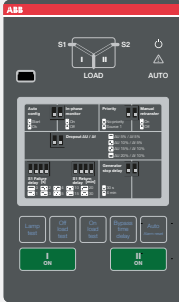
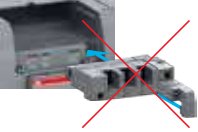
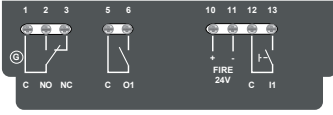
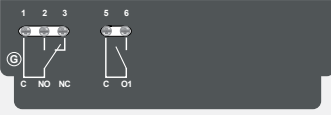

Operation types, TruONE® ATS, type OX_30...1600_		Ekip- modules suitable
Delayed transition, OXB_	Open transition, OXA_	
S1 I OII S2	S1 I II S2	
		
Load	Load	

#### Level 2: HMI (with DIP-switches) and connections of control circuit

		<p>Not suitable</p> 
		

Operation types, TruONE® ATS, type OX_30...1600_		Ekip-modules suitable
Delayed transition, OXB_	Open transition, OXA_	
S1 I OII S2	S1 I II S2	
		
Load	Load	

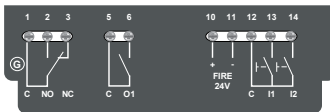
**Level 3: HMI (with LCD-screen) and connections of control circuit**

		 Suitable
		

**Level 4: HMI (with touch-screen) and connections of control circuit, sensor unit included**



		 Suitable
		

Table 2.1 The differences of controller level types / operation types and the suitability of Ekip-modules

## 2.2 HMI

HMI is the control interface (Human Machine Interface), available in three different level types. Level 2 contains the HMI with DIP-switches, Level 3 contains

the HMI with LCD-screen and level 4 contains the HMI with touch screen. The HMI is used for configuration and automatic operation.

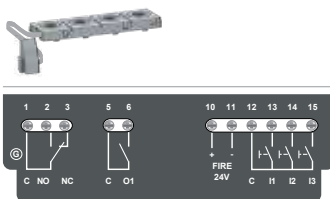
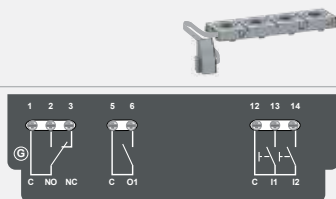
**Level 2:**  
HMI with  
DIP-switches

**Level 3:**  
HMI with  
LCD-screen

**Level 4:**  
HMI with  
touch screen

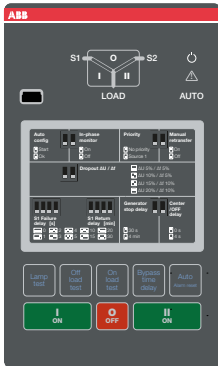

I - O - II (or II - O - I)



I - O - II (or II - O - I)



I - O - II (or II - O - I)

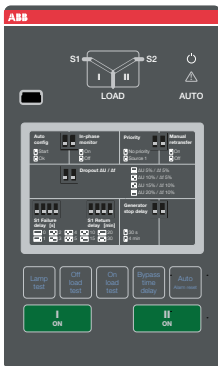

I - II (or II - I)



I - II (or II - I)



I - II (or II - I)

Fig. 2.2 HMIs available in three Level types: upper pictures; delayed transition I - O - II (or II - O - I) and lower pictures; open transition I - II (or II - I)

## 2.3 TruONE® ATS feature comparison

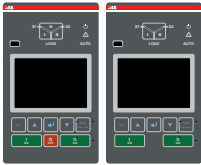
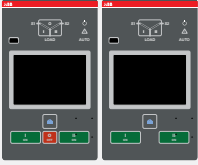
Feature comparison	Level 2 controls (DIP)	Level 3 controls (LCD)	Level 4 controls (TOUCH)
			
Ampere sizes available	IEC: 200...1600 A UL: 30...1200 A	IEC: 200...1600 A UL: 30...1200 A	IEC: 200...1600 A UL: 30...1200 A
Rated voltage	200...480 Vac	200...480 Vac	200...480 Vac
Rated frequency	50 / 60 Hz	50 / 60 Hz	50 / 60 Hz
Phase system	1 / 2 / 3	1 / 2 / 3	1 / 2 / 3
Number of poles	2, 3 and 4	2, 3 and 4	3 and 4
<b>Neutral configuration</b>			
Switched		Yes	Yes
Overlapping		No	Yes
<b>Product type</b>			
Open transition (I-II or II-I)		Yes	Yes
Delayed transition (I - O - II or II - O - I)		Yes	Yes
<b>Voltage and frequency settings</b>			
Pick up Voltage Source 1	Fixed 2% above drop out	71...99%, 101...119%	71...99%, 101...119%
Drop out Voltage Source 1	+/-5, 10, 15, 20%	70...98%, 102...120%	70...98%, 102...120%
Pick up Voltage Source 2	Fixed 2% above drop out	71...99%, 101...119%	71...99%, 101...119%
Drop out Voltage Source 2	+/-5, 10, 15, 20%	70...98%, 102...120%	70...98%, 102...120%
Pick up Frequency Source 1	Fixed 1% above drop out	80,5...99,5%, 100,5...119,5%	80,5...99,5%, 100,5...119,5%
Drop out Frequency Source 1	+/-5, 10%	80...99%, 101...120%	80...99%, 101...120%
Pick up Frequency Source 2	Fixed 1% above drop out	80,5...99,5%, 100,5...119,5%	80,5...99,5%, 100,5...119,5%
Drop out Frequency Source 2	+/-5, 10%	80...99%, 101...120%	80...99%, 101...120%
<b>Time delay settings</b>			
Override momentary Source 1 Outage, sec	0, 1, 2, 3, 4, 5, 10, 15, 20, 30	0...60	0...60
Transfer from source 1 to source 2, sec	2 (0...3600 via Ekip Connect)	0...3600	0...3600
Override momentary Source 2 Outage, sec	1,5 (0...60 via Ekip Connect)	0...60	0...60

**Feature comparison**

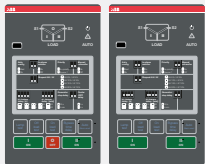
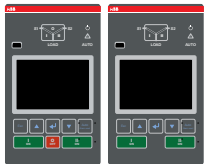
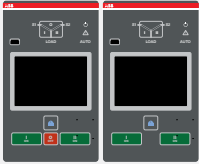
	Level 2 controls (DIP)	Level 3 controls (LCD)	Level 4 controls (TOUCH)
			
Transfer from source 2 to source 1, min	0, 1, 2, 3, 4, 5, 10, 15, 20, 30		0...120
Generator stop delay, min	30 secs or 4 mins		0...60
Center-OFF delay, sec		0 or 4	0...300
Pre-transfer delay S1 to S2, sec		No	0...300
Post-transfer delay S1 to S2, sec		No	0...300
Pre-transfer delay S2 to S1, sec		No	0...300
Post-transfer delay S2 to S1, sec		No	0...300
Elevator Pre-signal delay S1 to S2, sec		No	0...60
Elevator Post-signal delay S1 to S2, sec		No	0...60
Elevator Pre-signal delay S2 to S1, sec		No	0...60
Elevator Post-signal delay S2 to S1, sec		No	0...60
Load shed delay, sec		No	0...60
<b>Source failure detections</b>			
No voltage		Yes	Yes
Undervoltage		Yes	Yes
Overvoltage		Yes	Yes
Phase missing		Yes	Yes
Voltage unbalance		Yes	Yes
Invalid frequency		Yes	Yes
Incorrect phase sequence		Yes	Yes
<b>Features</b>			
Controls	DIP + keys	LCD + keys	Touch + keys
LED indications for ATS, S1 and S2 status	Yes	Yes	Yes
Open transition - Standard digital inputs/outputs	0 / 1	1 / 1	2 / 1
Delayed transition - Standard digital inputs/outputs	1 / 1	2 / 1	3 / 1
Programmable digital inputs/outputs	No	Yes	Yes

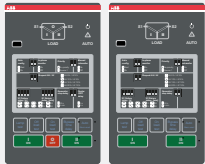
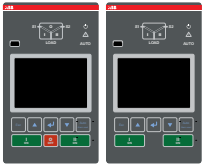
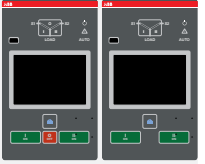
Feature comparison	Level 2 controls (DIP)	Level 3 controls (LCD)	Level 4 controls (TOUCH)	
				
Auto config (voltage, frequency, phase system)		Yes	Yes	Yes
Source priority	Source 1, No priority	Source 1/2, No priority	Source 1/2, No priority	
Manual retransfer	Yes	Yes	Yes	
In-phase monitor (synchro check)	Yes	Yes	Yes	
Genset exercising: on-load, off-load	Yes	Yes	Yes	
In-built power meter module	No	Accessory	Yes	
Load shedding	No	Yes	Yes	
Real time clock	Yes	Yes	Yes	
Event log	Via Ekip Connect		Yes	Yes
Predictive maintenance	No	No	Yes	
Harmonics measuring	No	Voltage	Voltage, current	
<b>Field-mount accessories</b>				
Auxiliary contacts for position indication	Yes	Yes	Yes	
Digital input/output modules	No	Yes	Yes	
12-24 Vdc aux supply module for controller	No	Yes	Yes	
Communication modules	No	Yes	Yes	
<b>Connectivity</b>				
Modbus RTU (RS-485)	No	Yes	Yes	
Modbus/TCP	No	Yes	Yes	
Profibus DP	No	Yes	Yes	
ProfiNet	No	Yes	Yes	
DeviceNet	No	Yes	Yes	
Ethernet IP	No	Yes	Yes	
IEC 61850	No	Yes	Yes	
Ekip Com Hub (monitoring via ABB Ability™: EDCS)	No	Yes	Yes	
<b>For applications</b>				
Mains - Mains	Yes	Yes	Yes	
Mains - Generator <sup>1)</sup>	Yes	Yes	Yes	

<sup>1)</sup> Contact ABB for applications with smaller than 20 kVA gensets

Table 2.2. ATS feature comparison, main features - but not limited to - in the table above

## 2.4 Typical applications

TruONE® automatic transfer switches are used for transferring a load automatically from one source to another.

Possible supply phase scenarios are located on following page. In Chapter 4 / Navigating menu / Parameters: Power distribution systems (Level 3 and Level 4), the considerations for supply phase system design are set forth in. Factory setting: 3 phases with neutral.

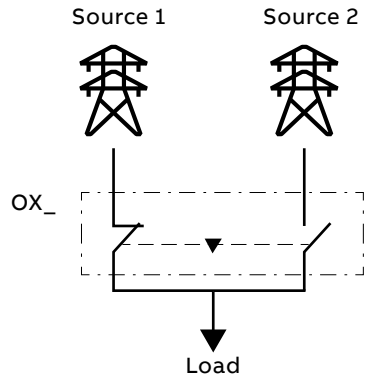
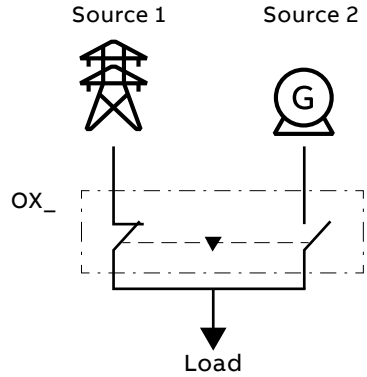
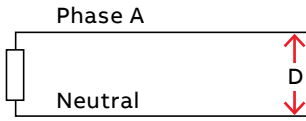
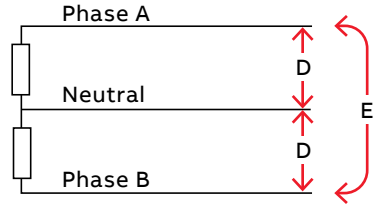

Fig. 2.3 Typical applications of automatic transfer switches



Single-phase, two-wire



Two-phase, three-wire

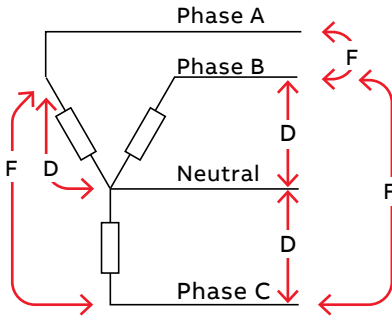

Three-phase, four-wire

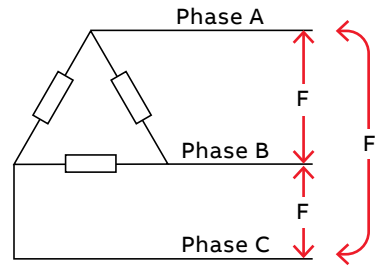

Three-phase, three-wire

D	E	F
200...480 Vac L-N	200...480 Vac L-L	200...480 Vac L-L

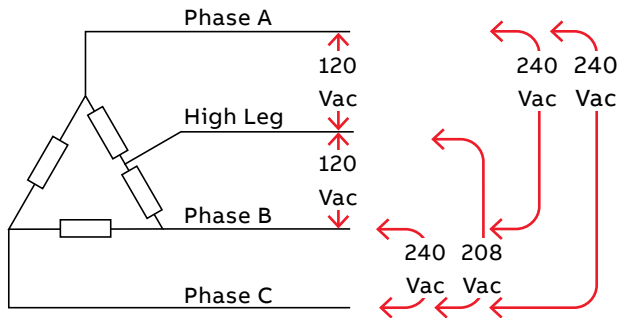

Three-phase, with high leg delta

A07482

Fig. 2.4 Possible supply phase scenarios

## 2.5 Description of basic functionality

### 2.5.1 Switching sequence / Automatic

#### 2.5.1.1 Source 1 Priority (Source 2 = Generator)

Switching sequence summary:

- An anomaly occurs on the source 1
- Override momentary S1 outage delay
- Generator start
- Source 2 OK
- Transfer from S1 to S2 delay
- Pre-transfer signal on
- Load shed signal on
- Pre-transfer S1 to S2 delay
- Load shed delay
- Transfer switch to the position O (only with delayed transition I-O-II type and at least one phase exists in source 1)
- Center-Off delay (only with delayed transition I-O-II type, delay is zero when all phases are missing in source 1)
- Transfer switch to the position II (source 2)
- Post-transfer S1 to S2 delay
- Pre-transfer signal off

Retransfer sequence summary:

- The source 1 is restored
- Transfer from S2 to S1 delay
- Pre-transfer signal on
- Pre-transfer S2 to S1 delay
- Transfer switch to the position O (only with delayed transition I-O-II type)
- Center-off delay (only with Delayed transition I - O - II type)
- Transfer switch to the position I (source 1)
- Load shed signal off
- Generator stop delay
- Post-transfer S2 to S1 delay
- Pre-transfer signal off
- Generator stop
- Source 2 off

**Source 1 priority (Source 2 = generator)**

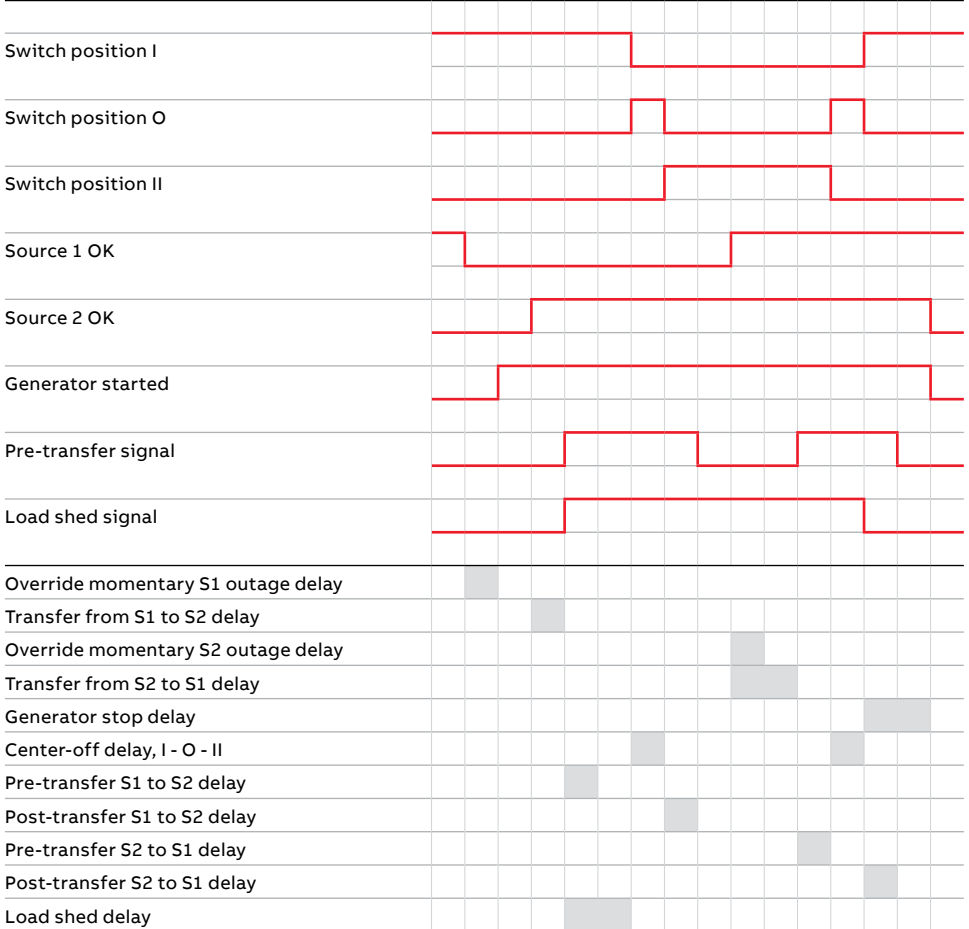

Note: The functionality and sequence of 'Elevator pre- and post-signals' is equivalent to 'Pre- and Post-transfer' features.

Table 2.3 Automatic Switching Sequences, Source 1 Priority (Source 2 = Generator)

### 2.5.1.2 Source 2 Priority (No generator)

Switching sequence summary:

- An anomaly occurs on the source 2
- Override momentary S2 outage delay
- Transfer from S2 to S1 delay
- Pre-transfer signal on
- Load shed signal on
- Pre-transfer S2 to S1 delay
- Load shed delay
- Transfer switch to the position O (only with delayed transition I-O-II type and at least one phase exists in source 2)
- Center-Off delay (only with delayed transition I-O-II type, delay is zero when all phases are missing in source 2)
- Transfer switch to the position I (source 1)
- Post-transfer S2 to S1 delay
- Pre-transfer signal off

Retransfer sequence summary:

- The source 2 is restored
- Transfer from S1 to S2 delay
- Pre-transfer signal on
- Pre-transfer S1 to S2 delay
- Transfer switch to the position O (only with delayed transition I-O-II type)
- Center-off delay (only with Delayed transition I - O - II type)
- Transfer switch to the position II (source 2)
- Load shed signal off
- Post-transfer S1 to S2 delay
- Pre-transfer signal off

**Source 2 priority (no generator)**

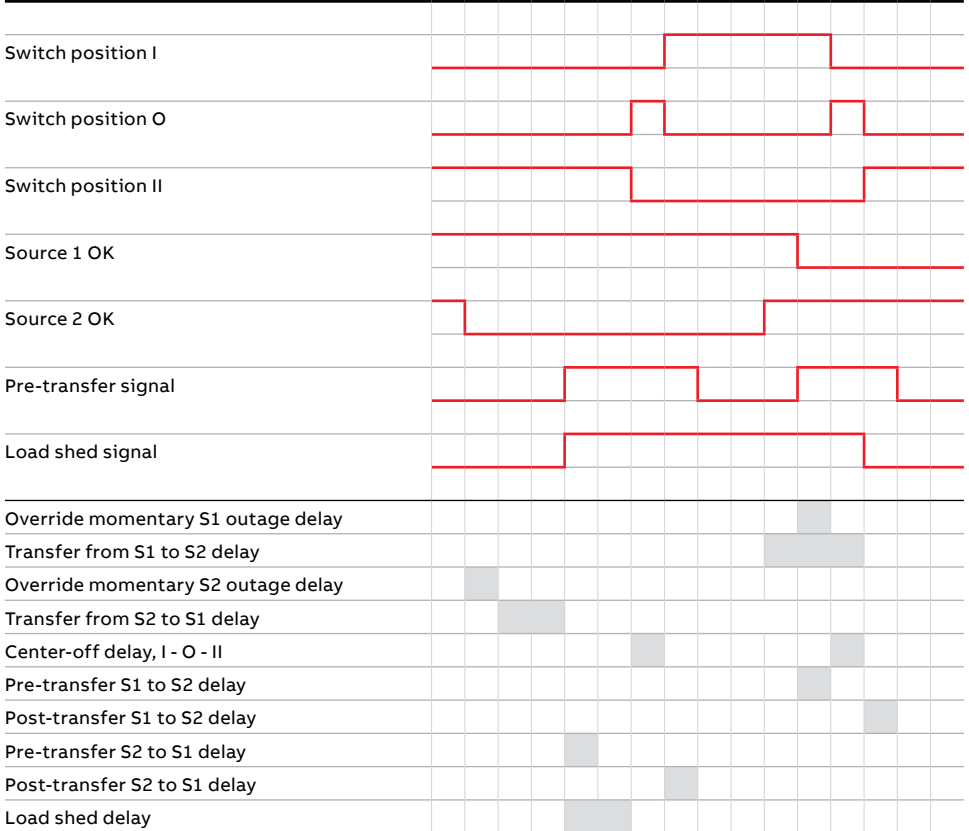

Note: The functionality and sequence of 'Elevator pre- and post-signals' is equivalent to 'Pre- and Post-transfer' features.

Table 2.4 Automatic Switching Sequences, Source 2 Priority (No generator)

### 2.5.1.3 No source Priority (Generator and load shed usage disabled)

Switching to available source:

- An anomaly occurs on the source 1
- Override momentary S1 outage delay
- Transfer from S1 to S2 delay
- Pre-transfer signal on
- Pre-transfer S1 to S2 delay
- Transfer switch to the position O (only with delayed transition I-O-II type and at least one phase exists in source 1)
- Center-Off delay (only with delayed transition I-O-II type, delay is zero when all phases are missing in source 1)
- Transfer switch to the position II (source 2)
- Post-transfer S1 to S2 delay
- Pre-transfer signal off

Retransfer steps following anomaly in the source functioning:

- The source 1 is restored
- An anomaly occurs on the source 2
- Transfer from S2 to S1 delay
- Pre-transfer signal on
- Pre-transfer S2 to S1 delay
- Transfer switch to the position O (only with delayed transition I-O-II type and at least one phase exists in source 2)
- Center-Off delay (only with delayed transition I-O-II type, delay is zero when all phases are missing in source 2)
- Transfer switch to the position I (source 1)
- Post-transfer S2 to S1 delay
- Pre-transfer signal off

**No Source priority (generator and load shed usage disabled)**

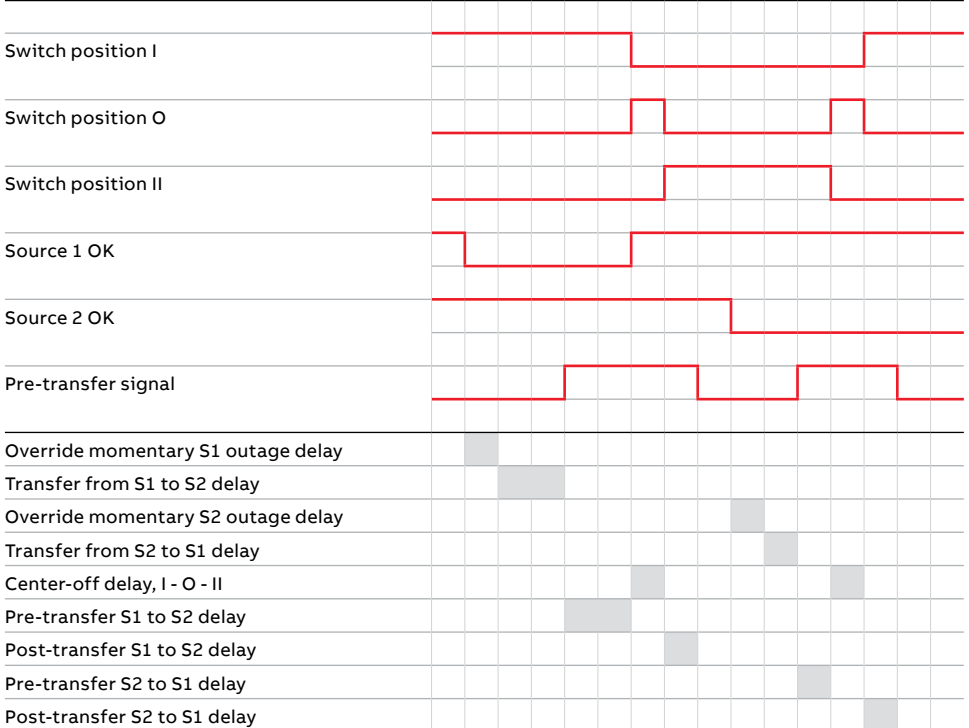

Note: The functionality and sequence of 'Elevator pre- and post-signals' is equivalent to 'Pre- and Post-transfer' features.

Table 2.5 Automatic Switching Sequences, No Source Priority (Generator and load shed usage disabled)

### 2.5.2 Automatic configuration

Automatic configuration sequence can be initiated by an HMI command. This function is able to detect basic system parameters:

- Rated voltage
- Rated frequency
- Source 1 power distribution system
- Source 2 power distribution system
- Neutral position
- Phase rotation

It is enough to have one source powered. Power distribution system is considered to be the same for both sources in this case.

User must finish the sequence manually with DIP HMI when fast blinking AUTO LED indicates that parameter detection is ready. Sequence ends automatically with other types.

### 2.5.3 In-phase monitor

In-phase monitor can be set On/Off by using HMI (controller levels 2, 3 and 4) or Ekip Connect tool (levels 3 and 4).

Function calculates the phase difference of voltage sources and enables the automatic transfer sequence I -> II or II -> I only when sources are synchronized. Frequency difference of the sources must be less than 3 Hz. Otherwise in-phase monitor activates the 'Frequency Difference' alarm and disables transfer operations.

Automatic transfer to a healthy source is enabled after a configurable time 'Synchronization Delay' when the device is able to detect frequency only in one source.

### 2.5.4 Powering supply scenarios

Device can be powered:

- Direct from source 1 or source 2: Whole device is powered and ATS can be operated electrically.
- Auxiliary power supply module, OXEA1: Powering the whole device (including HMI), but load transfer cannot be performed.
- Programming port on HMI (USB port): Powering only the main board. Allows software update to main device and connection of Ekip Connect commissioning tool.

## 3. Operating

### 3.1 Position indication

Contact movement and position indication is indicated in the figure below:

- Left side: Open transition I - II (or II - I)
- Right side: Delayed transition I - O - II (or II - O - I)

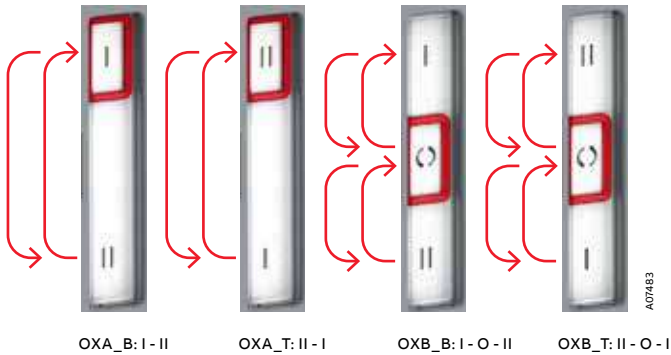

Fig. 3.1 Contact movement / position indication:  
 OXA\_, Open transition; OXB\_, Delayed transition,  
 \_B, bottom entry versions; \_T, top entry versions

## 3.2 Operating and locking

The operation mode is selected by using the slide switch (Hand - Locking - AUTO) located on the front of the automatic transfer switch (ATS).

- **Hand**-position = **Manual mode**, enabling emergency manual operation using the handle. ATS functionality is disabled when in Hand position.
- **Lock**-position = **Locking mode**, padlocking the automatic transfer switch in a specific position to prevent automatic and manual operation. Note! After the handle is set back to its place (standby slot), the slide switch will automatically move to the Locking mode and the switch is allowed to be padlocked. To set the operating handle back to its place, see the left picture in Fig. 3.6.
- **AUTO**-position = **Automatic or HMI operated switch control is enabled**. When the slide switch is moved to the AUTO position, automatic control mode is activated after a three second delay.
- **AUTO-Lock-AUTO** = **Alarm reset**

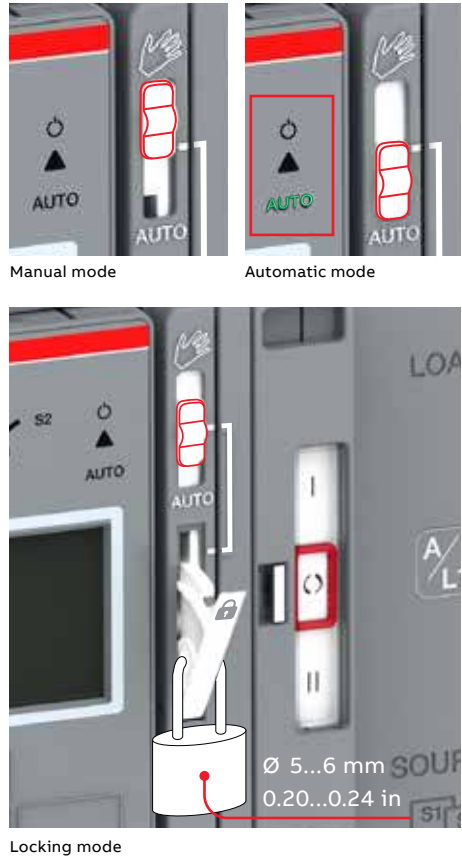

Fig. 3.2 Above the selection of the operation modes (Manual or Automatic) by the slide switch. Below padlocking the automatic transfer switch; After the handle is set back to its place (standby slot), the slide switch will automatically move to the Locking mode and the switch is allowed to be padlocked.

### 3.3 Manual mode, operating by the handle



**General warning**

Verify the condition of power source prior to manually transferring. Manual operation may result in out-of-phase transfer when both sources are energized.

Mount the handle; turn the slide switch to the Manual mode (Hand), locate and remove the handle from inside the ATS; Insert as shown in the bottom figure.

For more information, see video:  
Manual and automatic operation  
- TruONE® ATS (<https://youtu.be/bosvSPVi2sM>).



#### Manual mode

1

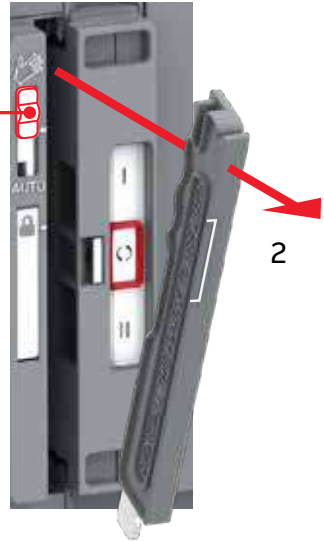

2



3

Fig. 3.3 Manual mode: installing handle

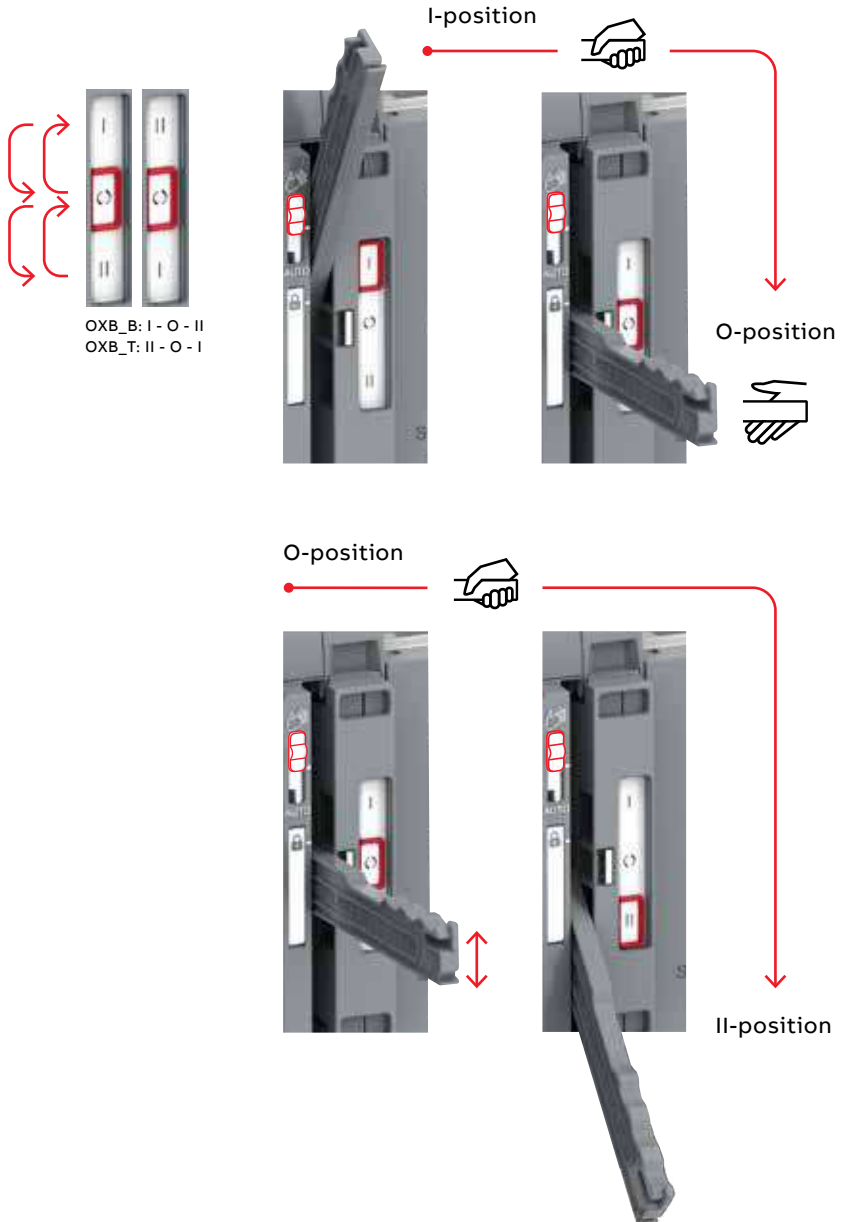

Fig. 3.4 Manual mode, operating by handle, delayed transition I - O - II or II - O - I. To move from position I to II (or II to I), move handle to O position and release hand from handle.

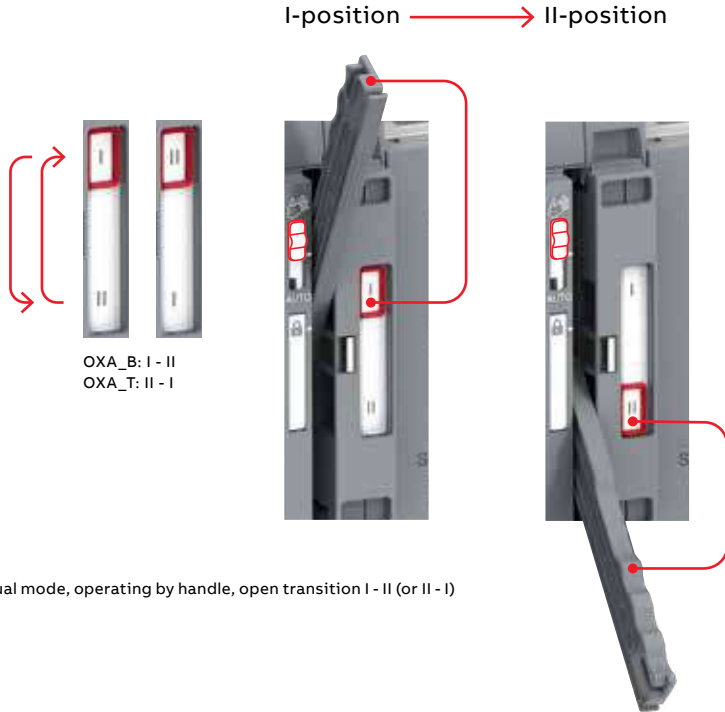

Fig. 3.5 Manual mode, operating by handle, open transition I - II (or II - I)

### 3.4 Automatic mode, operating by HMI

When operating the automatic transfer switch by HMI, turn the slide switch to Automatic mode (AUTO). Note! The handle must be in the standby slot (not in use) before turning to automatic mode.



**Information**  
When the slide switch is moved to the AUTO position, the automatic control mode is activated after a three second delay.

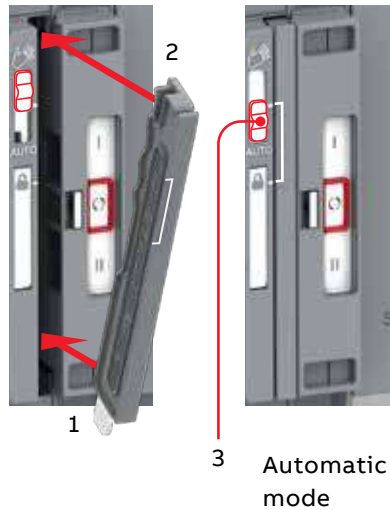

Fig. 3.6 The operating handle must set back to standby slot before moving to the automatic mode

## 3.5 LED functionality in HMI

LED functionality is common to every HMI-type.

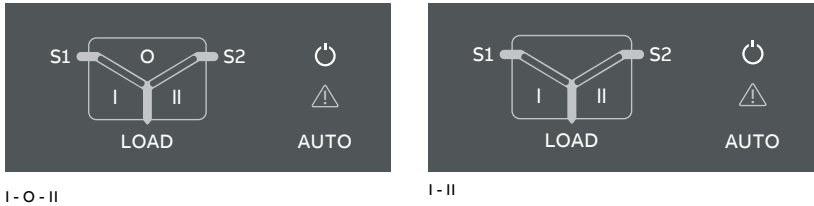













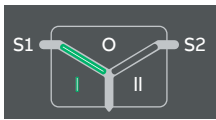

Fig. 3.7 On left: LEDs in OXB\_, delayed transition, I - O - II. On right: LEDs in OXA\_, open transition I - II.

LED	Indication	Description
<b>Power led</b>		
	ON, fixed light 	Power supply and communication present
	2 quick flashes/1s 	Power supply present, communication absent between switch and the HMI
	OFF 	No power available for HMI.
<b>S1 and S2 leds</b>		
	ON, fixed light 	S1 or / and S2 is present and within user defined limits
	2 quick flashes/1s 	Undervoltage
	Flash/1 s, 90%/10 % 	Invalid frequency
	Flash/1 s, 10%/90 % 	Unbalance
	5 flashes/1 s, 50%/50 % 	Overvoltage
	Flash/2 s, 50%/50% 	Incorrect phase sequence
	Flash/4 s, 50%/50 % 	Phase missing
	Flash/1 s, 50%/50 % 	Generator stop delay ongoing
	OFF 	No voltage

**I, II and O leds**



ON, fixed light █

Switch position is indicated with fixed light in I, O or II led. Only one can be illuminated



Flash/1 s, 50%/50 % █ █

Indicating running time delay

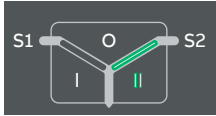

**Load led**

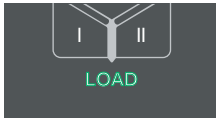

ON █

Supply ok and connected to load

OFF █

Connected supply to load not ok or load disconnected (switch in O position)

**Auto led**



ON, fixed light █

Switch is in automatic mode

Flash/1 s, 50%/50 % █ █

Test on load

Flash/1 s, 90%/10 % █ █

Test off load

5 flashes/1 s, 50%/50 % █ █ █ █ █ █ █ █ █ █

Autoconfig completed

**Alarm led**



OFF █

No alarms

ON, fixed light █

Handle attached, locked, other alarm

2 quick flashes/1s █ █ █ █

Control Alarm

5 flashes/1 s, 50%/50% █ █ █ █ █ █ █ █ █ █

Auto configuration ongoing

Flash/1 s, 50%/50% █ █

Control Retry

Flash/1 s, 10%/90% █ █

Auto mode off

Table 3.1 LED functionality, common to every HMI-type

## 3.6 Using Level 2 (DIP) control interface HMI

### 3.6.1 Keypad

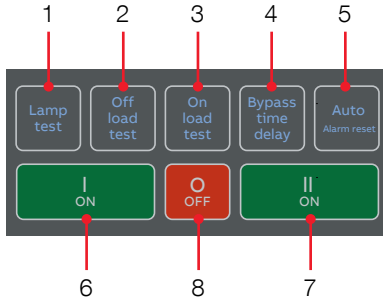

OXB\_, delayed transition, I - O - II

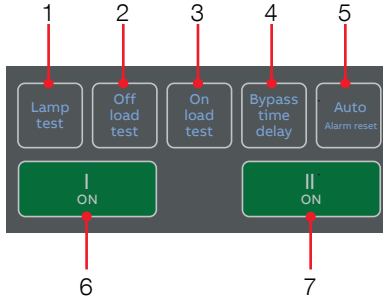

OXA\_, open transition, I - II

- 1 **Lamp test:** Turns on all LEDs simultaneously to confirm all LEDs are operational
- 2 **Off load test:** Initiates off load test (Starts generator but does not transfer the load to the generator)
- 3 **On load test:** Initiates on load test (Starts the generator and transfers the load to the generator)
- 4 **Bypass time delay:** Bypass any currently running time delay
- 5 **Auto (Alarm reset):** In the event of active switch control alarm (open I failure, close I failure, open II failure, close II failure), resets to no alarm state. If no active alarms, toggle between automatic/HMI control modes
- 6 **I ON:** Operate switch to I position
- 7 **II ON:** Operate switch to II position
- 8 **O OFF:** Operate switch to O position and disable automatic control mode (only in delayed transition I-O-II type)

Fig. 3.8 Keypad in Level 2 HMI with DIP-switches

### 3.6.2 Configuration by DIP-switches

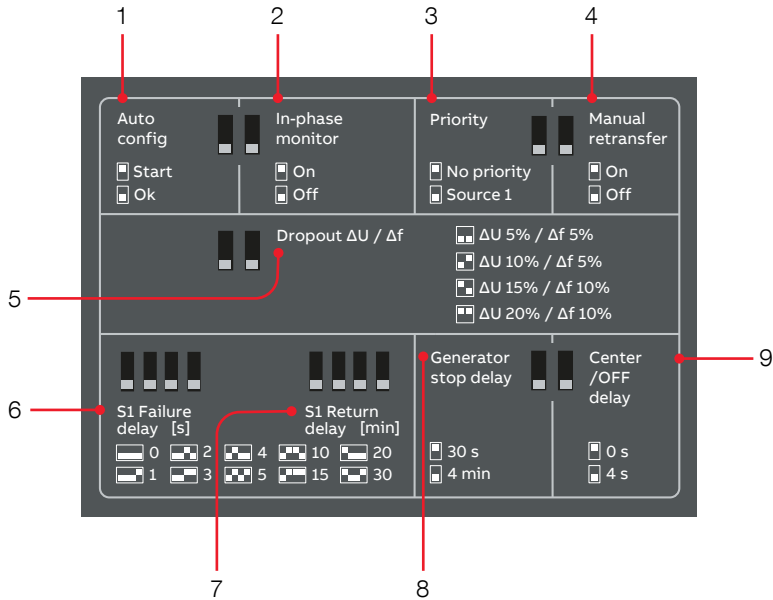

Fig. 3.9 DIP-switches for configuration in Level 2 HMI

**1 Auto config:** Automatically detecting Source 1 and Source 2 parameters. Automatic configuration sequence is started by setting DIP to 'Start' position. Parameter detection is ready when AUTO LED flashes at 5 Hz. After this the DIP must be set to 'Ok' position to resume normal operation. Check power supply of the voltage source in case the Alarm LED keeps flashing instead of AUTO LED. This

indicates that system parameters cannot be detected from the supplied voltage.

**2 In-phase monitor:**  
 On: Enable in-phase monitor  
 Off: Disable in-phase monitor

**3 Priority:**  
 No priority: Application 'Two Transformers / No Priority' selected  
 Source 1: Application 'S1-Transformer / S2-Generator' selected.

**4 Manual retransfer:**

On: Manual retransfer to priority source enabled (automatic retransfer disabled)

Off: Manual retransfer to priority source disabled (automatic retransfer enabled)

**5 Dropout  $\Delta U$  /  $\Delta F$ :**

Dropout voltage/frequency limit.

For example 5 % / 5 %:

Voltage source is considered acceptable when measured voltage is in range  $0.95 * U_n \dots 1.05 * U_n$  and measured frequency is in range  $0.95 * f_n \dots 1.05 * f_n$ .

**6 S1 Failure delay:** The time (0/1/2/3/4/5/10/15/20/30 s) device waits after priority source failure before starting automatic transfer sequence from priority source to non-priority source.

**7 S1 Return delay:** The time (0/1/2/3/4/5/10/15/20/30 min) device waits after priority source return before starting automatic retransfer sequence from non-priority source to priority source.

**8 Generator stop delay:** The time (30 s or 4 min) device waits after transferring back to priority source before stopping the generator.

**9 Center-Off delay:** The time (0 s or 4 s) device waits in O position during automatic transfer sequence I -> II or II -> I (only delayed transition I-O-II type). This delay is always 0 s in case all phases are missing in the original source.

### 3.7 Using Level 3 (LCD) control interface HMI

#### 3.7.1 Keypad

- 1 **Esc:** Go back in menu. When pressed in root page, the alarm list is shown.
- 2 **Up, Down:** Move in menu or choose parameter values.
- 3 **Enter:** Opens menu in root page. Enter a new menu page and accept function.
- 4 **Auto (Alarm reset):** In the event of active switch control alarm (open I failure, close I failure, open II failure, close II failure), resets to no alarm state. If no active alarms, toggle between automatic/HMI control modes.
- 6 **II ON:** Operate switch to II position.
- 7 **O OFF:** Operate switch to O position and disable automatic control mode (only in delayed transition I-O-II type).

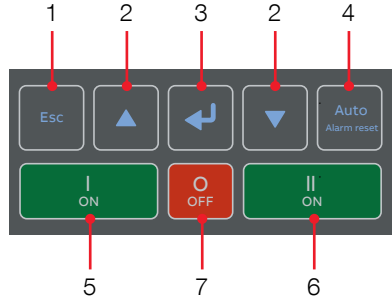

OXB\_, delayed transition, I - O - II

#### 3.7.2 Navigating in menu

See the menu tree in Chapter 4.

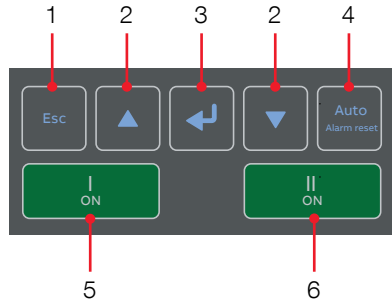

OXA\_, open transition, I - II

Fig. 3.10 Keypad in Level 3 HMI with LCD screen

LCD

## 3.8 Using Level 4 (touch) control interface HMI

### 3.8.1 Keypad

- 1 **Home Button:** Opens up the root menu or brings user to the homepage if defined. While viewing a specific page, it can be defined as the home page by pressing the home button for 3 seconds. All pages, except for the menus, can be set as home page. Home page is automatically shown after inactivity.
- 2 **I ON:** Operate switch to I position.
- 3 **II ON:** Operate switch to II position.
- 4 **O OFF:** Operate switch to O position and disable automatic control mode (only in delayed transition I-O-II type).

### 3.8.2 Navigating in menu

See the menu tree in Chapter 4.

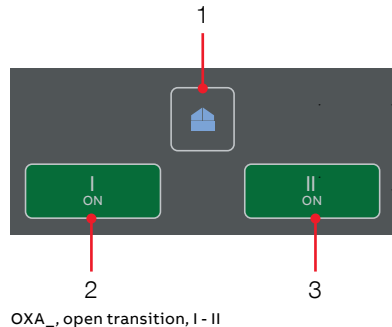
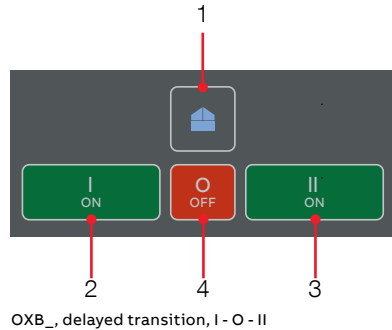

Fig. 3.11 Keypad in Level 4 HMI with touch screen

## 4. Navigating menu

### 4.1 Level 3 (LCD) control interface, menu tree

The default password is 00001, enter the password when prompted (see Fig. 4.1).

The keypad is described In Chapter 3.7, see Fig. 3.10. By pressing the Enter-key (3) you can:

- open the menu in root page
- enter a new menu page
- accept the function

By pressing Up and Down -keys (2) you can:

- move in the menu
- choose the parameter value

By pressing Esc-key (1) you can:

- go back in the menu

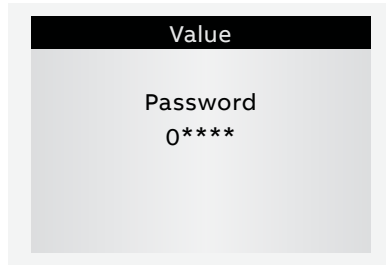

Fig. 4.1 Enter the password when asked, choose the right number by Up and Down -keys (2) and confirm by Enter-key (3), go forward setting number after number

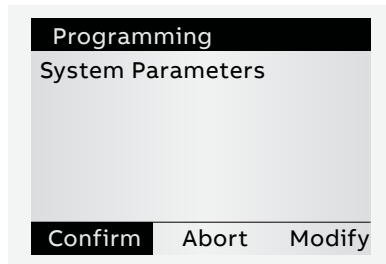

Fig. 4.2 After you have changed the parameter, always go back in the menu by pressing Esc-key and when prompted confirm changes with Enter-key

## Description of the icons

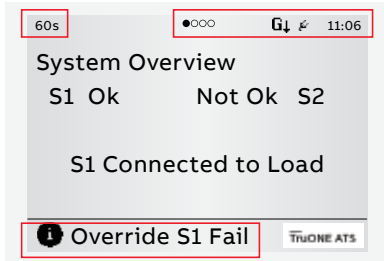

Fig. 4.3 Location of the small icons and the alarms

## Alarm List

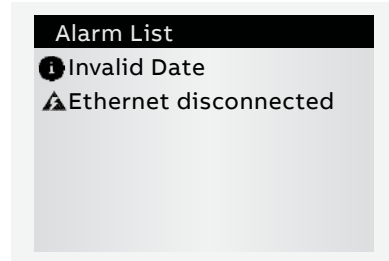

Fig. 4.4 When pressed Esc-key (1) in System Overview -pages, the alarm list is shown.

The small icons in System Overview -pages are:

### On upper right corner

●○○○○○ Indicates the amount of pages and the page where you are at the moment



Auxiliary voltage connected

11:06 Time



Application set up as Transformer-Generator. Generator start-up signal deactivated



Application set up as Transformer-Generator. Generator start-up signal activated

### On upper left corner

60s Time delay, in Alarm list you can see the name of delay at the same time, e.g. Override S1 Fail

**On the lower edge** of the screen you can see the Alarms. When pressed Esc-key (1) in System Overview -pages, the alarm list is shown.



#### Information

The default values are marked in the menu tree by \*-marking.

**4.1.1 Start screens**

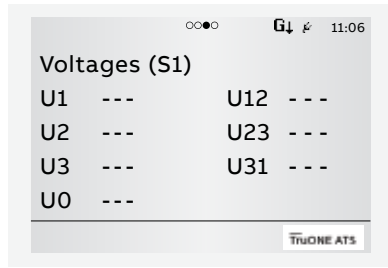
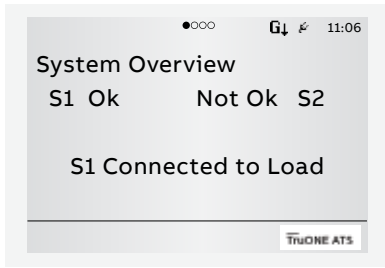

Fig. 4.5 From System Overview screen you will find Switch status and Supply info views, and by pressing Up and Down -keys (2), you can go forward to see Voltages and Synchronization view, see the table below.

**Start screens**

**System Overview (Switch status)**

Shows voltages and frequencies of both supplies and the switch position.

**Supply info view**

Shows Phase to Phase voltages of both supplies and the frequencies.

**Voltages (S1)**

S1 phase voltages

S1 line voltage

**Voltages (S2)**

S2 phase voltages

S2 line voltage

**Synchronization view**

Enabled only when In-phase monitor is on.

Show the time to next sync, sync period

**Current view**

Enabled only when current measurement module is connected.

Phase currents

Neutral current

Residual current

**Active Power view**

Enabled only when current measurement module is connected.

Active power by phase

Total active power

**Reactive Power view**

Enabled only when current measurement module is connected.

Reactive power by phase

Total reactive power

**Apparent Power view**

Enabled only when current measurement module is connected.

Apparent power by phase

Total apparent power

**Energy Counters view**

Enabled only when current measurement module is connected.

Active energy by source

Reactive energy by source

Apparent energy by phase

Total active energy

Total reactive energy

Total apparent energy

## 4.1.2 Enter key, main menu

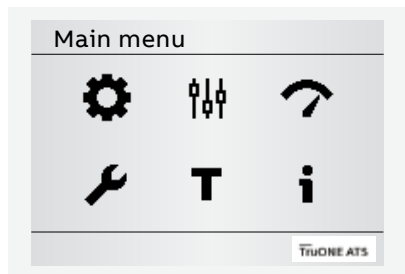



Fig. 4.6

By pressing Enter-key (3) you will move to the main menu page of Operation, Parameters, Measurements, Settings, Test and About, see the table below for the selections. You can move in menu or choose parameter values by Up and Down -keys (2) and by Enter-key (3) you can accept function and enter a new menu page. By Esc-key (1) you can go back in menu.



### Information

When you have changed the parameter, always go back in the menu by pressing Esc-key and when prompted confirm changes with Enter-key.

Operation		*Default
	Bypass Time Delay	Bypass any currently running time delay
	HMI Control Keys (I, II)	Enabled* Disabled
	Energy Counters	Reset

Parameters	*Default
 System parameters	
Start Automatic Configuration	
Power distribution systems (see Fig. 2.2)	
Source 1	1 Phase, 2 Wire
	2 Phases, 3 Wire (Split Neutral)
	3 Phases, no Neutral (3ph3w)
	3 Phase with Neutral (3ph4w)*
	3 Phase, High-Leg Delta
Source 2	1 Phase, 2 Wire
	2 Phases, 3 Wire (Split Neutral)
	3 Phases, no Neutral (3ph3w)
	3 Phase with Neutral (3ph4w)*
	3 Phase, High-Leg Delta
Rated Voltage	
	200 V (3ph), 208 V (3ph), 220 V (3ph), 230 V (3ph), 240 V (3ph), 277 V (3ph), 347 V (3ph), 380 V (3ph), <b>400 V (3ph)*</b> , 415 V (3ph), 440 V (3ph), 460 V (3ph), 480 V (3ph), 200 V (1ph), 220 V (1ph), 230 V (1ph), 240 V (1ph), 254 V (1ph), 265 V (1ph), 277 V (1ph), 318 V (1ph), 333 V (1ph), 347 V (1ph), 380 V (1ph), 400 V (1ph), 415 V (1ph), 440 V (1ph), 460 V (1ph), 480 V (1ph)
Rated Frequency	
	50 Hz*
	60 Hz
Neutral Position	
	Pole 4*
	Pole 1
Phase Sequence	
	ABC*
	ACB
	Not Enabled

Continued on the next page

1  
LCD

Parameters (continued)	*Default
------------------------	----------



Device Parameters	
In-phase Monitor	
Enable	Off*
	On
Synchronization Delay	0*...60 s
Time Delays	
Override S1 Failure	0...60 s (2* s)
Transfer from S1 to S2	0...60 min (2* s)
Pre-transfer S1 to S2	0*...300 s
Center-off	0*...300 s
Post-transfer S1 to S2	0*...300 s
Override S2 Failure	0...60 s (2* s)

S1 priority: How long the device is waiting S1 recovery before starting transfer sequence to S2.  
S2 priority: How long the device is keeping the load on failed S1 although S2 is already available.

S1 priority: How long the device is keeping the load on failed S1 after S2 becomes available.  
S2 priority: How long the device waits before transfer sequence back to available S2 begins. This delay is bypassed by 'Override S1 Failure' in case of S1 failure.

Enabled only when any digital output is configured as 'Pre-transfer Signal'.  
How long the device is keeping pre-transfer signal activated before transferring from S1 to S2.

Only delayed transition I-O-II type. How long the switch is stopped at position O while transferring from S1 to S2 or from S2 to S1 and the original source is not completely down.  
Center-OFF delay is bypassed in case all phases are missing from the original source which we are leaving.

Enabled only when any digital output is configured as 'Pre-transfer Signal'.  
How long the device is keeping pre-transfer signal activated after transferring from S1 to S2.

S1 priority: How long the device is keeping the load on failed S2 although S1 is already available.  
S2 priority: How long the device is waiting S2 recovery before starting transfer sequence to S1.

Continued on the next page

Parameters (continued)	*Default
------------------------	----------



Device Parameters (continued)		
Time Delays (continued)		
Transfer from S2 to S1	0...120 min (2* s)	S1 priority: How long the device waits before transfer sequence back to available S1 begins. This delay is overridden by 'Override S2 Failure' in case of S2 failure. S2 priority: How long the device is keeping the load on failed S2 although S1 is already available.
Pre-transfer S2 to S1	0*...300 s	Enabled only when any digital output is configured as 'Pre-transfer Signal'. How long the device is keeping pre-transfer signal activated before transferring from S2 to S1.
Post-transfer S2 to S1	0*...300 s	Enabled only when any digital output is configured as 'Pre-transfer Signal'. How long the device is keeping pre-transfer signal activated after transferring from S2 to S1.
Generator Stop	0...60 min (5* min)	Enabled only when generator is in use. Generator cooling time, how long the device is keeping the generator running without load after returning to priority source.
Load Shed	0*...60 s	Enabled only when any digital output is configured as 'Load Shed'. How long before the transfer from priority to non-priority source the device activates load shed signal.
Elevator Pre-signal S1 to S2	0*...60 s	Enabled only when any digital output is configured as 'Elevator pre-signal'. How long the device is keeping pre-signal signal activated before transferring from S1 to S2.
Elevator Post-signal S1 to S2	0*...60 s	Enabled only when any digital output is configured as 'Elevator pre-signal'. How long the device is keeping pre-signal signal activated after transferring from S1 to S2.
Elevator Pre-signal S2 to S1	0*...60 s	Enabled only when any digital output is configured as 'Elevator pre-signal'. How long the device is keeping pre-signal signal activated before transferring from S2 to S1.
Elevator Post-signal S2 to S1	0*...60 s	Enabled only when any digital output is configured as 'Elevator pre-signal'. How long the device is keeping pre-signal signal activated after transferring from S2 to S1.

Continued on the next page

**Parameters (continued)****\*Default**

## Device Parameters (continued)

## Voltage &amp; Frequency Setpoints

Defines the voltage and frequency limits for source being acceptable. Source has an anomaly when measured voltage/frequency goes out of range drop-out lower/drop-out Upper. Source becomes acceptable when measured voltage/frequency goes back in range pick-up lower/pick-up higher.

## S1 Setpoints

S1 Drop-out Voltage	Upper Threshold	102...120 % Un (115* % Un)
	Lower Threshold	70...98 % Un (85* % Un)
S1 Pick-up Voltage	Upper Threshold	101...119 % Un (114* % Un)
	Lower Threshold	71...99 % Un (86* % Un)
S1 Drop-out Frequency	Upper Threshold	101...120 % fn (115* % fn)
	Lower Threshold	80...99 % fn (85* % fn)
S1 Pick-up Frequency	Upper Threshold	100.5...119.5 % fn (114* % fn)
	Lower Threshold	80.5...99.5 % fn (86* % fn)

## S2 Setpoints

S2 Drop-out Voltage	Upper Threshold	102...120 % Un (115* % Un)
	Lower Threshold	70...98 % Un (85* % Un)
S2 Pick-up Voltage	Upper Threshold	101...119 % Un (114* % Un)
	Lower Threshold	71...99 % Un (86* % Un)
S2 Drop-out Frequency	Upper Threshold	101...120 % fn (115* % fn)
	Lower Threshold	80...99 % fn (85* % fn)
S2 Pick-up Frequency	Upper Threshold	100.5...119.5 % fn (114* % fn)
	Lower Threshold	80.5...99.5 % fn (86* % fn)

## Generator Exercisers

Switch and generator functioning can be tested automatically and also periodically by using four independent exerciser events. Test on load function starts the generator and transfers the load to it. Test off load function only starts the generator for the duration of the event. Overlapping events are prioritized, event 1 has the highest priority.

## Exerciser 1 / 2 / 3 / 4

Status	Disabled*
	Non-periodic
	Daily
	Weekly
	Bi-weekly
	Monthly
	Yearly

Continued on the next page

**Parameters (continued)** **\*Default**



Device Parameters (continued)

Generator Exercisers (continued)

Exerciser 1 / 2 / 3 / 4 (continued)

Function	No Function*
	Test on Load
	Test off load
Duration (hh:mm:ss)	00:00:00...24:00:59 (00:01:00*)
Time (hh:mm)	Starting time of the event: 00:00*...23:59
Date (month day, year)	Starting date of the event Jan 01, 2000... (---*)

Application

- S1-Transformer/S2-Generator\*
- S2-Transformer/S1-Generator
- 2 Transformers/S1 Priority
- 2 Transformers/S2 Priority
- 2 Transformers/No Priority

Manual Retransfer

Off*	Automatic retransfer sequence enabled. Load is automatically retransferred to priority source upon the restoration of priority source.
On	Automatic retransfer sequence disabled. Load will be kept on non-priority source until operator manually (by HMI or manual handle) or remotely operates the load back to priority source. Load is also retransferred when the feature is set OFF.

Commit Transfer

Off*	If priority source fails, device cancels the transfer sequence to non-priority source (generator) if priority source returns before non-priority source becomes acceptable.
On	If priority source fails, device continues transfer sequence to non-priority source (generator) even if priority returns before non-priority source becomes acceptable. Retransfer sequence according to time delays.

Transfer to Dead Source

On*	User can transfer to an unavailable source by using HMI keys I/II or by a remote command.
Off	Transfer to an unavailable source is disabled.

1  
LCD

## Measurements



### Switch Diagnostics

Total operations	I-O-II switches: Total number of transfers I-O, O-II, II-O and O-I. I-II switches: Total number of transfers I-II and II-I.
Manual operations	Total transfers operated by the handle.
Number of load transfers	Total number of transfers I-II and II-I.
Transfer time	Time it took to transfer the load between sources (ms).
Source fail transfers	Total number of automatic transfers due to source failures.
Days energized	
Total time on S1	Hours
Total time on S2	Hours
Time S1 available	Minutes
Time S2 available	Minutes
Last generator start	MMM DD, YYYY hh:mm:ss
Generator starting time	How long it took for the generator to become acceptable after latest start (s).
In-phase time	How long it took for the in-phase monitor to achieve synchronized transfer (s).

Event Log 250 time stamped events, latest first.

Harmonics Harmonic components up to 15th are calculated for the selected phase.

Measured Phase	Disabled*
	Phase 1
	Phase 2
	Phase 3
Voltage	Total distortion THD for each phase of both voltage sources.
	S1 Components Each harmonic component of the selected S1 phase.
	S2 Components Each harmonic component of the selected S2 phase.

Power Factor Enabled only when current measurement module is connected.

**Settings****\*Default**

## Standard I/O Settings

## I 01 / I 02 / I 03

Function	No function	Input disabled.
Emergency Stop* (default in I 01)		Transfers to O position in delayed transition I-O-II type switches. Disables automatic control mode in both delayed and open transition types.
Remote Test On Load* (default in I 02)		Start/stop test on load sequence in rising (NO) or falling (NC) edge of the input signal.
Remote Test Off Load* (default in I 03)		Start/stop test off load sequence in rising (NO) or falling (NC) edge of the input signal.
Inhibit AUTO Mode		Prevent switch control operations, configuration, test sequences and generator start in case of priority source failure.
Manual Retransfer		Disables automatic transfer back to priority source.
Source Priority S1		Sets priority for source 1 in transformer-transformer application.
Source Priority S2		Sets priority for source 2 in transformer-transformer application.
Inhibit Transfer		Disables automatic transfer from priority source to non-priority source.
Bypass Running Time Delays		Bypass any currently running time delay
Remote Control to S1		Transfer to S1 when active. Overridden by activated 'Remote Control to OFF' signal.
Remote Control to OFF		Transfer to O position when active.
Remote Control to S2		Transfer to S2 when active. Overridden by activated 'Remote Control to OFF' or 'Remote Control to S1' signals.
Reset Alarm		Reset any active switch control alarms (open I failure, close I failure, open II failure, close II failure)
Manual-Auto Mode		Toggle automatic/HMI control mode, input is active only in rising/falling edge according to contact type.
Contact type	NC	Active open.
	NO*	Active closed.

## O 01

Function	No Function	Output disabled.
Alarm / Product availability*		Signals any active alarms or ATS being disabled for automatic transfer operations.
Load Connected to S1		Switch in position I.
Load Disconnected		Switch in position O.
Load Connected to S2		Switch in position II.

Continued on the next page

**Settings (continued)****\*Default**

## Standard I/O Settings (continued)

## O 01 (continued)

## Function (continued)

Pre-transfer Signal		Signal is activated and transfer is delayed according to pre-transfer delay. Signal is kept activated according to post-transfer delay after transfer.
Source 1 Available		No anomalies in S1 voltage supply.
Source 2 Available		No anomalies in S2 voltage supply.
Load Shed 1		Used for shedding non-essential loads before transferring to non-priority source. Signal is activated before transferring to non-priority source according to load shed delay and kept activated until load is transferred back to priority source.
Elevator pre-signal		Signal is activated and transfer is delayed according to Elevator pre-signal delay. Signal is kept activated according to Elevator post-signal delay after transfer.
Contact type	NC	Active open.
	NO*	Active closed.

## Modules (See Chapter 5, Electronic accessories)

## System

RESET to Factory Setting		Restore default parameter values.
Date <sup>1)</sup>		Month day, year
Time <sup>1)</sup>		Hours:Minutes
Language		English*
		Italian
		French
		German
		Spanish
		Russian
		Chinese
New Password		Five digits
Temperature Unit		Celsius*
		Fahrenheit
Clock Format	24 h*	
	12 h	
Display Contrast	10 - 100% (30 %*)	

<sup>1)</sup> RTC capacitor must be charged before inserting Date/Time. RTC capacitor is charged from source voltage (not AUX) and takes about 10 minutes. RTC capacitor keeps the date/time saved for 48 h in case of no source voltage available.

Test	*Default	
<b>T</b>	On-Load Test Settings	
	Bypass Local Test	
	Bypass if Gen. fails*.	
	Stay on Gen.	
	Bypass Remote Test	
	Bypass if Gen. fails*.	
	Stay on Gen.	
	Test On Load	Test generator with transferring the load. Test with switch transfer.
	Test off Load	Test generator without transferring the load. Test without switch transfer.
	HMI Test	Initiate display test screen and turn all LEDs on.
Optional modules (See Chapter 5, Electronic accessories)		

About	
<b>i</b>	HMI
	HMI serial number
	Software version
	Software subversion
	HMI Type code
	Controller Unit
	Time
	Date
	Serial number
	Normative
Controller software version	
Controller software subversion	
Automatic Transfer Switch	
TAG name	
ATS Type Code	
ATS serial number	
Rated current	
Number of poles	
ATS Type	
Modules (See Chapter 5, Electronic accessories)	

LCD 1

### 4.1.3 Esc key

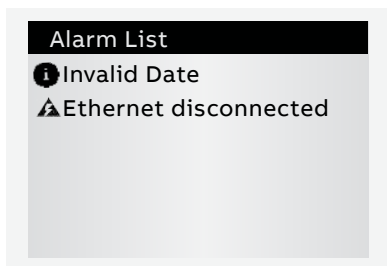

Fig. 4.7

By pressing Esc-key (1) in System Overview  
-pages, the alarm list is shown.

---

#### Alarm list

---

More information, see chapter 6, Troubleshooting

---

## 4.2 Level 4 (touch) control interface, menu tree

### Password

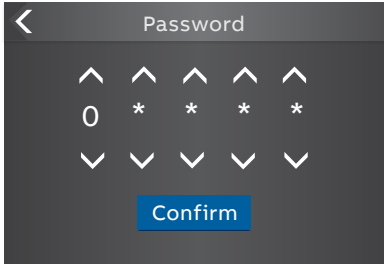

Fig. 4.8

The default password is 00001, enter the password when prompted (see Fig. 4.1).

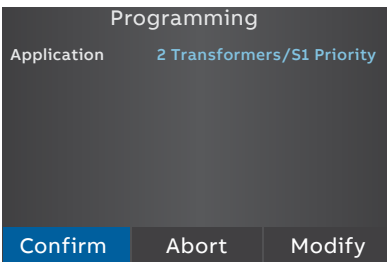

Fig. 4.9

Fig. 4.8

Enter the password when asked, choose the right number by arrowheads and confirm, go forward entering number after number

Fig. 4.9

After you have changed the parameter, go back in the menu by pressing the < on the top left corner or Home key and when prompted confirm changes by Confirm option'

Fig. 4.10

The location of the small icons and the alarms

### Description of the icons



Fig. 4.10

The small icons in System Overview -pages are:

#### On upper right corner

●○○○ Indicates the amount of pages and the page where you are at the moment



Auxiliary voltage connected

11:06 Time



Application set up as Transformer-Generator. Generator start-up signal deactivated



Application set up as Transformer-Generator. Generator start-up signal activated

#### On upper left corner

60s Time delay, in Alarm list you can see the name of delay at the same time, e.g. Override S1 Fail

## Alarm List

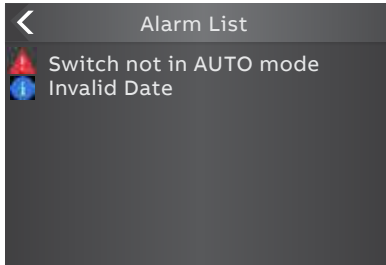

Fig. 4.11

**On the lower edge** of the screen you can see the Alarms. If you touch on the alarm you will get the Alarm List.

## To define the home page

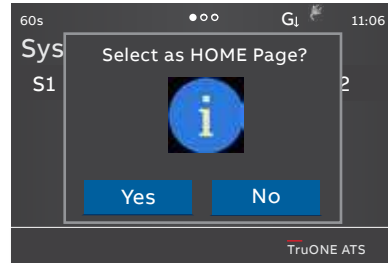

Fig. 4.12

While viewing a specific page, it can be defined as the home page by pressing the home button for 3 seconds. All pages, except for the menus, can be set as home page. Home page is automatically shown after inactivity.

Fig. 4.11

By touching on the alarm indication on the lower edge of the screen you will get the Alarm List

Fig. 4.12

Home page definition, acceptance of the function

## 4.2.1 Start Menu

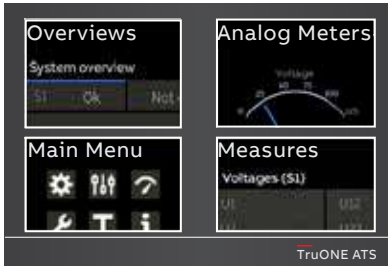

Fig. 4.13

Fig. 4.13 By touching on one of Start Menu choices, you can choose the Overviews -pages (upper left corner), Main Menu -pages (lower left corner), Analog Meters -pages (upper right corner) or Measures -pages (lower right corner)

Fig. 4.14 By touching on Start Menu upper left corner -image you can move to the Overviews -pages, where you will find Switch status and Supply info views, see the table below

### 4.2.1.1 Overviews

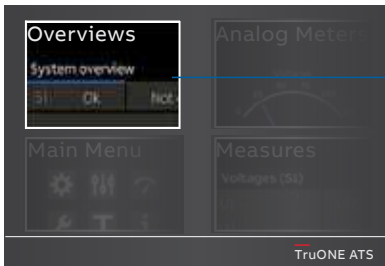
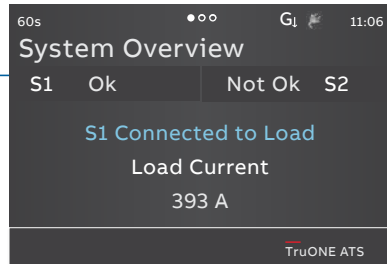

Fig. 4.14



---

#### System Overview (Switch status)

---

Shows voltages and frequencies of both supplies and the switch position.

---

#### Supply info view

---

Shows voltages and frequencies of both supplies.

---

#### Temperature view

---

Shows the HMI, device and pole temperatures.

HMI temperature indicates ambient temperature where the ATS power panel is installed, when HMI is mounted to door.

Device temperature indicates the temperature inside the ATS power panel.

Pole temperature indicates the temperature on the load side terminals.

---

#### Synchronization view (Enabled only when In-phase monitor is on)

---

Show the time to next sync, sync period.

---



**Parameters** **\*Default**



System parameters

Start Automatic Configuration

Power distribution systems (see Fig. 2.2)

Source 1

1 Phase, 2 Wire

2 Phases, 3 Wire (Split Neutral)

3 Phases, no Neutral (3ph3w)

3 Phase with Neutral (3ph4w)\*

3 Phase, High-Leg Delta

Source 2

1 Phase, 2 Wire

2 Phases, 3 Wire (Split Neutral)

3 Phases, no Neutral (3ph3w)

3 Phase with Neutral (3ph4w)\*

3 Phase, High-Leg Delta

Rated Voltage 200 V (3ph), 208 V (3ph), 220 V (3ph), 230 V (3ph), 240 V (3ph), 277 V (3ph), 347 V (3ph), 380 V (3ph), 400 V (3ph)\*, 415 V (3ph), 440 V (3ph), 460 V (3ph), 480 V (3ph), 200 V (1ph), 220 V (1ph), 230 V (1ph), 240 V (1ph), 254 V (1ph), 265 V (1ph), 277 V (1ph), 318 V (1ph), 333 V (1ph), 347 V (1ph), 380 V (1ph), 400 V (1ph), 415 V (1ph), 440 V (1ph), 460 V (1ph), 480 V (1ph)

Rated Frequency 50 Hz\*

60 Hz

Neutral Position Pole 4\*

Pole 1

Phase Sequence ABC\*

ACB

Not Enabled

Continued on the next page

TOUCH

**Parameters (continued)****\*Default**

## Device Parameters

## In-phase Monitor

Enable	Off*
	On

Synchronization Delay	0*...60 s
-----------------------	-----------

## Time Delays

Override S1 Failure	0...60 s (2* s)	S1 priority: How long the device is waiting S1 recovery before starting transfer sequence to S2. S2 priority: How long the device is keeping the load on failed S1 although S2 is already available.
Transfer from S1 to S2	0...60 min (2* s)	S1 priority: How long the device is keeping the load on failed S1 after S2 becomes available. S2 priority: How long the device waits before transfer sequence back to available S2 begins. This delay is bypassed by 'Override S1 Failure' in case of S1 failure..
Pre-transfer S1 to S2	0*...300 s	Enabled only when any digital output is configured as 'Pre-transfer Signal'. How long the device is keeping pre-transfer signal activated before transferring from S1 to S2.
Center-Off	0*...300 s	Only delayed transition I-O-II type. How long the switch is stopped at position O while transferring from S1 to S2 or from S2 to S1 and the original source is not completely down. Center-OFF delay is bypassed in case all phases are missing from the original source which we are leaving.
Post-transfer S1 to S2	0*...300 s	Enabled only when any digital output is configured as 'Pre-transfer Signal'. How long the device is keeping pre-transfer signal activated after transferring from S1 to S2.

Continued on the next page

## Parameters (continued)

\*Default



## Device Parameters (continued)

## Time Delays (continued)

Override S2 Failure	0...60 s (2* s)	S1 priority: How long the device is keeping the load on failed S2 although S1 is already available. S2 priority: How long the device is waiting S2 recovery before starting transfer sequence to S1.
Transfer from S2 to S1	0...120 min (2* s)	S1 priority: How long the device waits before transfer sequence back to available S1 begins. This delay is overridden by 'Override S2 Failure' in case of S2 failure. S2 priority: How long the device is keeping the load on failed S2 although S1 is already available.
Pre-transfer S2 to S1	0*...300 s	Enabled only when any digital output is configured as 'Pre-transfer Signal'. How long the device is keeping pre-transfer signal activated before transferring from S2 to S1.
Post-transfer S2 to S1	0*...300 s	Enabled only when any digital output is configured as 'Pre-transfer Signal'. How long the device is keeping pre-transfer signal activated after transferring from S2 to S1.
Generator Stop	0...60 min (5* min)	Enabled only when generator is in use. Generator cooling time, how long the device is keeping the generator running without load after returning to priority source.
Load Shed	0*...60 s	Enabled only when any digital output is configured as 'Load Shed'. How long before the transfer from priority to non-priority source the device activates load shed signal.
Elevator Pre-signal S1 to S2	0*...60 s	Enabled only when any digital output is configured as 'Elevator pre-signal'. How long the device is keeping pre-signal signal activated before transferring from S1 to S2.
Elevator Post-signal S1 to S2	0*...60 s	Enabled only when any digital output is configured as 'Elevator pre-signal'. How long the device is keeping pre-signal signal activated after transferring from S1 to S2.
Elevator Pre-signal S2 to S1	0*...60 s	Enabled only when any digital output is configured as 'Elevator pre-signal'. How long the device is keeping pre-signal signal activated before transferring from S2 to S1.
Elevator Post-signal S2 to S1	0*...60 s	Enabled only when any digital output is configured as 'Elevator pre-signal'. How long the device is keeping pre-signal signal activated after transferring from S2 to S1.

Continued on the next page

**Parameters (continued)****\*Default****Device Parameters (continued)****Voltage & Frequency Setpoints**

Defines the voltage and frequency limits for source being acceptable. Source has an anomaly when measured voltage/frequency goes out of range drop-out lower/drop-out Upper. Source becomes acceptable when measured voltage/frequency goes back in range pick-up lower/pick-up higher.

**S1 Setpoints**

S1 Drop-out Voltage	Upper Threshold	102...120 % Un (115* % Un)
	Lower Threshold	70...98 % Un (85* % Un)
S1 Pick-up Voltage	Upper Threshold	101...119 % Un (114* % Un)
	Lower Threshold	71...99 % Un (86* % Un)
S1 Drop-out Frequency	Upper Threshold	101...120 % fn (115* % fn)
	Lower Threshold	80...99 % fn (85* % fn)
S1 Pick-up Frequency	Upper Threshold	100.5...119.5 % fn (114* % fn)
	Lower Threshold	80.5...99.5 % fn (86* % fn)

**S2 Setpoints**

S2 Drop-out Voltage	Upper Threshold	102...120 % Un (115* % Un)
	Lower Threshold	70...98 % Un (85* % Un)
S2 Pick-up Voltage	Upper Threshold	101...119 % Un (114* % Un)
	Lower Threshold	71...99 % Un (86* % Un)
S2 Drop-out Frequency	Upper Threshold	101...120 % fn (115* % fn)
	Lower Threshold	80...99 % fn (85* % fn)
S2 Pick-up Frequency	Upper Threshold	100.5...119.5 % fn (114* % fn)
	Lower Threshold	80.5...99.5 % fn (86* % fn)

Continued on the next page

**Parameters (continued)** **\*Default**



**Device Parameters (continued)**

**Generator Exercisers**

Switch and generator functioning can be tested automatically and also periodically by using four independent exerciser events. Test on load function starts the generator and transfers the load to it. Test off load function only starts the generator for the duration of the event. Overlapping events are prioritized, event 1 has the highest priority.

**Exerciser 1 / 2 / 3 / 4**

<b>Status</b>	Disabled*
	Non-periodic
	Daily
	Weekly
	Bi-weekly
	Monthly
	Yearly
<b>Function</b>	No Function*
	Test on Load
	Test off load
<b>Duration (hh:mm:ss)</b>	00:00:00...24:00:59 (00:01:00*)
<b>Time (hh:mm)</b>	Starting time of the event. 00:00*...23:59
<b>Date (month day, year)</b>	Starting date of the event Jan 01, 2000... (---*)

**Application**

- S1-Transformer/S2-Generator\*
- S2-Transformer/S1-Generator
- 2 Transformers/S1 Priority
- 2 Transformers/S2 Priority
- 2 Transformers/No Priority

Continued on the next page

TOUCH 1

Parameters (continued)		*Default
	Device Parameters (continued)	
	Manual Retransfer	
	Off*	Automatic retransfer sequence enabled. Load is automatically retransferred to priority source upon the restoration of priority source.
	On	Automatic retransfer sequence disabled. Load will be kept on non-priority source until operator manually (by HMI or manual handle) or remotely operates the load back to priority source. Load is also retransferred when the feature is set OFF.
	Commit Transfer	
	Off*	If priority source fails, device cancels the transfer sequence to non-priority source (generator) if priority source returns before non-priority source becomes acceptable.
	On	If priority source fails, device continues transfer sequence to non-priority source (generator) even if priority returns before non-priority source becomes acceptable. Retransfer sequence according to time delays.
	Transfer to Dead Source	
	On*	User can transfer to an unavailable source by using HMI keys I/II or by a remote command.
	Off	Transfer to an unavailable source is disabled.

**Measurements**



**Switch Diagnostic**

Total operations	I-O-II switches: Total number of transfers I-O, O-II, II-O and O-I. I-II switches: Total number of transfers I-II and II-I
Manual operations	Total transfers operated by the handle.
Number of load transfers	Total number of transfers I-II and II-I
Transfer time	Time it took to transfer the load between sources (ms)
Source fail transfers	Total number of automatic transfers due to source failures.
Days energized	
Total time on S1	Hours
Total time on S2	Hours
Time S1 available	Minutes
Time S2 available	Minutes
Last generator start	MMM DD, YYYY hh:mm:ss
Generator starting time	How long it took for the generator to become acceptable after latest start (s).
In-phase time	How long it took for the in-phase monitor to achieve synchronized transfer (s).

**Event Log** 250 time stamped events, latest first.

**Harmonics** Harmonic components up to 15th are calculated for the selected phase.

Measured Phase	Disabled*	
	Phase 1	
	Phase 2	
	Phase 3	
Voltage	Total distortion	THD for each phase of both voltage sources.
	S1 Components	Each harmonic component of the selected S1 phase.
	S2 Components	Each harmonic component of the selected S2 phase.

**Power Factor** Enabled only when current measurement module is connected.

TOUCH

**Settings****\*Default**

## Standard I/O settings

## I 01 / I 02 / I 03

Function	No function	Input disabled
Emergency Stop* (default in I 01)		Transfers to O position in delayed transition I-O-II type switches. Disables automatic control mode in both delayed and open transition types.
Remote Test On Load* (default in I 02)		Start/stop test on load sequence in rising (NO) or falling (NC) edge of the input signal.
Remote Test Off Load* (default in I 03)		Start/stop test off load sequence in rising (NO) or falling (NC) edge of the input signal.
Inhibit AUTO Mode		Prevent switch control operations, configuration, test sequences and generator start in case of priority source failure.
Manual Retransfer		Disables automatic retransfer back to priority source.
Source Priority S1		Sets priority for source 1 in transformer-transformer application.
Source Priority S2		Sets priority for source 2 in transformer-transformer application.
Inhibit Transfer		Disables automatic transfer from priority to non-priority source.
Bypass Running Time Delays		Bypass any currently running time delay.
Remote Control to S1		Transfer to S1 when active. Overridden by activated 'Remote Control to OFF' signal.
Remote Control to OFF		Transfer to O position when active.
Remote Control to S2		Transfer to S2 when active. Overridden by activated 'Remote Control to OFF' or 'Remote Control to S1' signals.
Reset Alarm		Reset any active switch control alarms (open I failure, close I failure, open II failure, close II failure).
Manual-Auto Mode		Toggle automatic/HMI control mode, input is active only in rising/falling edge according to contact type.
Contact Type	NC	Active open
	NO*	Active closed

## O 01

Function	No Function	Output disabled
Alarm / Product availability*		Signals any active alarms or ATS being disabled for automatic transfer operations.
Load Connected to S1		Switch in position I.
Load Disconnected		Switch in position O.
Load Connected to S2		Switch in position II.

Continued on the next page

**Settings (continued)** **\*Default**



Standard I/O settings (continued)

O 01 (continued)

Function (continued)

Pre-transfer Signal		Signal is activated and transfer is delayed according to pre-transfer delay. Signal is kept activated according to post-transfer delay after transfer.
Source 1 available		No anomalies in S1 voltage supply.
Source 2 available		No anomalies in S2 voltage supply.
Load Shed 1		Used for shedding non-essential loads before transferring to non-priority source. Signal is activated before transferring to non-priority source according to load shed delay and kept activated until load is transferred back to priority source.
Elevator pre-signal		Signal is activated and transfer is delayed according to Elevator pre-signal delay. Signal is kept activated according to Elevator post-signal delay after transfer.
Contact Type	NC NO*	Active open. Active closed.

Modules

See Chapter 5, Electronic accessories

System

RESET to Factory Setting		Restore default parameter values
Date <sup>1)</sup>		Month day, year
Time <sup>1)</sup>		Hours:Minutes
Language	English* Italian French German Spanish Russian Chinese	
New Password		Five digits
Temperature Unit	Celsius* Fahrenheit	
Clock Format	24 h* 12 h	

<sup>1)</sup> RTC capacitor must be charged before inserting Date/Time. RTC capacitor is charged from source voltage (not AUX) and takes about 10 minutes. RTC capacitor keeps the date/time saved for 48 h in case of no source voltage available.

TOUCH

**Settings (continued)****\*Default**

View

## Ammeter Phase

I Max\*

Ne

L1

L2

L3

## S1 Voltmeter Phase

V Max\*

U12

U23

U31

## S2 Voltmeter Phase

V Max\*

U12

U23

U31

Test	*Default
	On-Load Test Settings
	Bypass Local Test
	Bypass Remote Test
	Test On Load
Test Off Load	Test generator without transferring the load. Test without switch transfer.
HMI Test	Initiate display test screen and turn all LEDs on.
Optional modules (See Chapter 5, Electronic accessories)	

## About

	HMI	HMI serial number
		Software version
		Software subversion
		HMI Type code
Controller Unit	Time	
	Date	
	Serial number	
	Normative	
	Controller software version	
	Controller software subversion	
Automatic Transfer Switch	TAG name	
	ATS Type Code	
	ATS serial number	
	Rated current	
	Number of Poles	
	ATS Type	
Modules (See Chapter 5, Electronic accessories)		

### 4.2.1.3 Analog meters

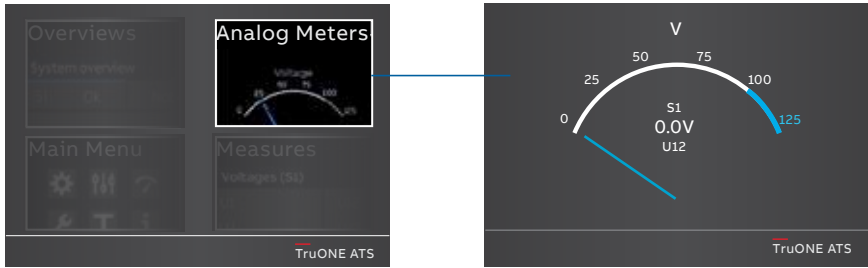

Fig. 4.16 By touching on Start Menu upper right corner -image you can find the analog meters information, see the table below

---

S1 Voltage meter

S2 Voltage meter

Current meter

Power meter

VAR meter

VA meter

---

#### 4.2.1.4 Measures

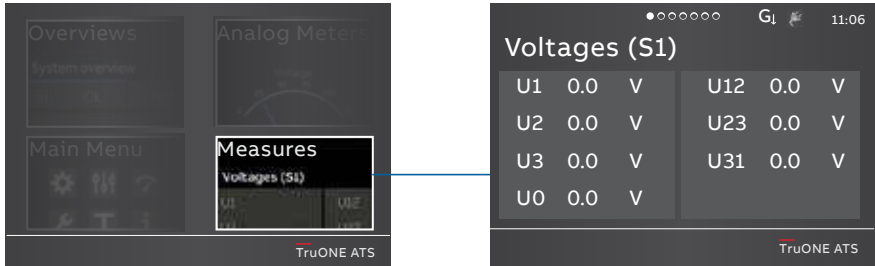

Fig. 4.17 By touching on Start Menu lower right corner -image you can find the measured data, see the table below

---

Voltages (S1)

Voltages (S2)

Current

Active power

Reactive power

Apparent power

Energy counters

---

## 5. Electronic accessories

Ekip Connect Software and Bluetooth and Programming -modules are suitable for all TruONE automatic transfer switches, see chapters 5.1...5.3.

- Ekip Connect -software
- Ekip Bluetooth -module
- Ekip Programming -module

Ekip Signalling and Com -modules are available for TruONE automatic transfer switches with Level 3 and Level 4 controllers (LCD and touch control interfaces). These modules are mounted with auxiliary power supply module, OXEA1 (see the mounting in section 2, Chapter 9, Mounting of accessories).

Ekip-modules mounted with auxiliary power supply module are (see chapters 5.4 ...5.6):

- Ekip signalling modules;
  - Ekip signalling 2K-1-OX
  - Ekip signalling 2K-2-OX
  - Ekip signalling 2K-3-OX
- Ekip Com modules;
  - Ekip Com Modbus RTU-OX
  - Ekip Com Modbus TCP-OX
  - Ekip Com Profibus DP
  - Ekip Com DeviceNet
  - Ekip Com Profinet
  - Ekip Com EtherNet/IP
  - Ekip Com IEC 61850
  - Ekip Com Hub



Fig. 5.1 Programming and bluetooth -modules

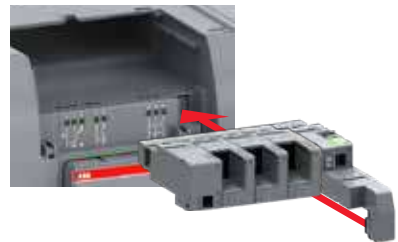

Fig. 5.2 Ekip Signalling and Com -modules are mounted to TruONE automatic transfer switch with a auxiliary power supply module, OXEA1

## 5.1 Using Ekip Connect -software

Ekip Connect is a free software for communication and testing of TruONE automatic transfer switches. The software is compatible with all TruONE automatic transfer switches. It can be installed on PCs equipped with the Microsoft Windows® operating system. Download it from the site, see the address below: <http://www.abb.com/abblibrary/DownloadCenter/>

With its communication function, it allows you to:

- Monitor the state of the connected automatic transfer switches and record information.
- Configure automatic transfer switches with customized parameters.
- Configure electronic accessories, connected to automatic transfer switch via Local Bus.
- Download information from automatic transfer switches.
- Create communication reports.
- Reset configurations.

Further information on the Ekip Connect application is available from the web site, see the address below, in particular in the manual 1SDH000891R0002.

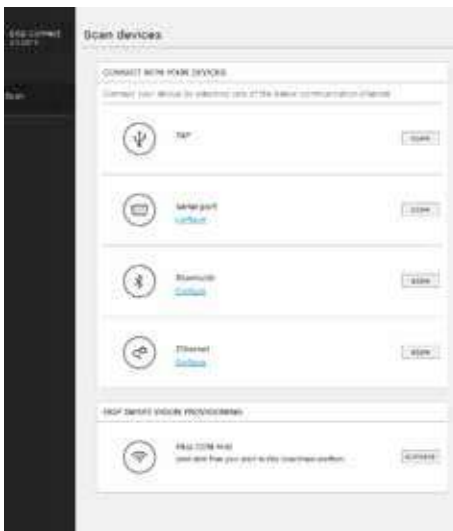

Fig. 5.3 Ekip Connect -software

## 5.2 Using Ekip Bluetooth-module

The Ekip Bluetooth allows connection via Bluetooth between the automatic transfer switch and a support (PC, tablet, or smart phone) with the Ekip Connect software installed (see the previous paragraph). Ekip Bluetooth -module is suitable to use with all TruONE automatic transfer switches.

It draws its power from a rechargeable lithium-polymer battery supplied with the unit. It is connected directly to the programming port (see Fig. 5.6) and allows the controller without auxiliary voltage to be powered. The programming port can only be used with Ekip Bluetooth and Ekip Programming -modules.



### Information

The Ekip Bluetooth module can be used without powering the mains. (Local Bus Accessories, including HMI, are not operative).

### Note

Ekip Bluetooth only powers the controller (HMI and modules excluded). Therefore, in order to recognize all connected modules with Ekip Connect, the auxiliary power supply module, type OXEA1, must be used (see chapter 5.4).

### 5.2.1 Signallings

Ekip Bluetooth -module is switched on by pressing the power button on the side, and is equipped with two LEDs:

- The first lit in green with the device on and the battery charge, red with the device turned on and low battery.
- The second flashing blue with active Bluetooth communication.



Fig. 5.4 Ekip Bluetooth-module

## 5.3 Using Ekip Programming -module

Ekip Programming -module is suitable to use with all TruONE automatic transfer switches. You can connect the module via the programming port, see Fig. 5.6. The programming port can only be used with Ekip Programming and Ekip Bluetooth -modules.

Ekip Programming -module allows you to:

- With Ekip Connect software update the softwares and load, set and read the parameters



### Information

The Ekip Programming module can be used without powering the mains. (Local Bus Accessories, including HMI, are not operative).

Ekip Programming -module draws its power from the PC and connects one side directly to the programming port (see Fig. 5.6) and on the other to the USB ports of the PC with the cable supplied.

### Note

Ekip Programming only powers the main switch (HMI and modules excluded). Therefore, in order to recognize all connected modules with Ekip Connect, the auxiliary power supply module, type OXE A1, must be used (see chapter 5.4).

### 5.3.1 Signallings

Ekip Programming -module turns on after connecting to the PC, and is equipped with two LEDs, a green one indicating that the module is on, and a yellow one indicating active communication.



Fig. 5.5 Ekip Programming -module



Fig. 5.6 Programming port (USB port) is situated in the front of the HMI, on left side

## 5.4 Auxiliary power supply module

The auxiliary power supply module, type OXE1, supplies non-insulated power to the external Ekip-modules, HMI and main control unit. It is supplied by external supply, for example from generator battery or from isolated transformer connected to the main circuit. Powering product only with Auxiliary power supply module limits some operation functions of the main

control unit, for example: Operation of Sensor module isn't possible.

Connections are push-in spring terminals, no tool is required.

For external wiring, cable cross section; AWG 22-16 / 0,5-1,5 mm<sup>2</sup>.

### 5.4.1 Electrical characteristics

The following table lists the electrical characteristics:

Module	OXEA1
Power supply input voltage	12 - 24 V DC $\pm$ 10% SELV
Nominal power consumption	5 - 12 W
Inrush current	Maximum 2 A

Table 5.1 Electrical characteristics of auxiliary power supply module OXE1



Fig. 5.7 Auxiliary power supply module, type OXE1, is needed when Ekip Signalling and Com -modules are mounted to TruONE automatic transfer switch

### 5.4.2 Signallings

LED	Indication	Description
Power LED, green	On, fixed	Power is connected to the input of the module.
	Off	Power is not connected.

Table 5.2 Indication / auxiliary power supply module OXE1



Fig. 5.8 Signals of auxiliary power supply module OXE1

## 5.5 Using Ekip Signalling 2K-\_-module

The Ekip Signalling 2K-\_- is a signalling accessory module. It is suitable for Level 3 and Level 4 controllers (LCD and touch control interfaces). The module has:

- Two digital inputs, and two contacts for output signals.
- A power status LED, and four signalling LEDs (one LED for every input/output).



### Information

On each ATS, a maximum of three Ekip Signalling 2K modules can be installed: one 2K-1, one 2K-2, and one 2K-3. These modules differ by their name and label, and have distinct wiring, but they are identical in terms of their characteristics and manner of installation.

Component	Characteristics
Output contacts	Maximum switching voltage*: 150 V DC / 250 V AC
	Breaking power*: 2 A @ 30 V DC, 0.8 A @ 50 V DC, 0.2 A @ 150 V DC, 4 A @ 250 V AC
	Dielectric strength between each contact and coil: 1000 V AC (1 minute @ 50 Hz)
Input contacts	Dielectric strength between open contacts: 1000 V AC (1 minute @ 50 Hz)
	5V@2.5mA Do not connect to any power supply

\*Data relating to a resistive load

Table 5.3 Electrical characteristics of Ekip Signalling 2K-\_-module

### 5.5.1 Electrical characteristics of Ekip Signalling 2K-\_-module

The following table lists the electrical characteristics of the module:



Fig. 5.9 Ekip Signalling 2K-\_-module

### 5.5.2 Access from the display / Ekip Signalling 2K-\_-module

With modules energized, and Local Bus enabled, the presence of the modules on the module slot activates additional menus on the display:

- In order to configure the inputs and output contacts.
- To display information on the modules and the state of inputs and outputs.

The following table illustrates the path for accessing the configuration parameters of the module from the display:

<b>Settings (*Default)</b>		<b>Description</b>
<b>Modules (Optional modules)</b>		
<b>Ekip Signalling 2K-1 / -2 / -3</b>		
<b>I 11/12, I 21/22, I 31/32</b>		
Function	No Function*	Input disabled
	Emergency Stop	Transfers to O position in delayed transition I-O-II type switches. Disables automatic control mode in both delayed and open transition types.
	Remote Test on Load	Start/stop test on load sequence in rising (NO) or falling (NC) edge of the input signal.
	Remote Test off Load	Start/stop test off load sequence in rising (NO) or falling (NC) edge of the input signal.
	Inhibit AUTO Mode	Prevent switch control operations, configuration, test sequences and generator start in case of priority source failure.
	Manual Retransfer	Disables automatic transfer back to priority source.
	Source Priority S1	Sets priority for source 1 in transformer-transformer application.
	Source Priority S2	Sets priority for source 2 in transformer-transformer application.
	Inhibit Transfer	Disables automatic transfer from priority source to non-priority source.
	Bypass Running Time Delays	Bypass any currently running time delay.
	Remote Control to S1	Transfer to S1 when active. Overridden by activated 'Remote Control to OFF' signal.
	Remote Control to OFF	Transfer to position O when active.
	Remote Control to S2	Transfer to S2 when active. Overridden by activated 'Remote Control to OFF' or 'Remote Control to S1' signals.
	Reset Alarm	Reset any active switch control alarms (open I failure, close I failure, open II failure, close II failure).
	Manual-Auto Mode	Toggle automatic/HMI control mode, input is active only in rising/falling edge according to contact type.
Contact Type	NC	Active open
	NO*	Active closed
<b>O 11/12, O 21/22, O 31/32</b>		
Function	No Function*	Output disabled
	Alarm/Product Availability	Signals any active alarms or ATS being disabled for automatic transfer operations.
	Load Connected to S1	Switch in position I.
	Load Disconnected	Switch in position O.
	Load Connected to S2	Switch in position II.
	Pre-transfer Signal	Signal is activated and transfer is delayed according to pre-transfer delay. Signal is kept activated according to post-transfer delay after transfer.

Continued on the next page

Settings (*Default) (continued)		Description
Modules (Optional modules) (continued)		
Ekip Signalling 2K-1 / -2 / -3 (continued)		
O 11/12, O 21/22, O 31/32 (continued)		
Function (continued)		
	Source 1 Available	No anomalies in S1 voltage supply.
	Source 2 Available	No anomalies in S2 voltage supply.
	Load Shed 1	Used for shedding non-essential loads before transferring to non-priority source. Signal is activated before transferring to non-priority source according to load shed delay and kept activated until load is transferred back to priority source.
	Elevator pre-signal	Signal is activated and transfer is delayed according to Elevator pre-signal delay. Signal is kept activated according to Elevator post-signal delay after transfer.
Contact	NC	Active open
Type	NO*	Active closed

## Test

:		
Modules (Optional modules)		
	Ekip Signalling 2K-1 / -2 / -3	Auto Test
:		

Table 5.5 Configuration and test parameters of Ekip Signalling 2K-\_-module in HMI

The following table illustrates the path from the display for accessing information on the module:

About	Description
:	
Modules (Optional modules)	
Ekip Signalling 2K-1 / -2 / -3	
SN	Serial number
Version	Software version
Input 1	The logical state of the inputs: "Off" if not active, "On" if active
Input 2	
Output 1	The state of the output contacts: "Open" if open, "Closed" if closed
Output 2	
:	

Table 5.4 Information of Ekip Signalling 2K-\_-module in HMI

### 5.5.3 Signals and inputs/outputs of Ekip Signalling 2K\_-module

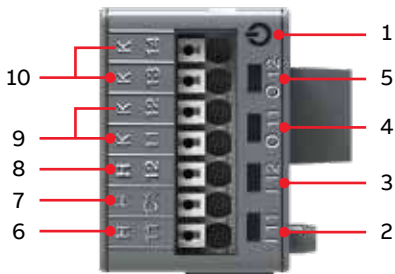

Fig. 5.10 Signals and inputs/outputs of Ekip Signalling 2K\_-module

- 1 Power LED, green. The possible states are:
  - Off: power supply absent.
  - On fixed: power supply and communication with the device present (with a device with the Alive LED option disabled).
  - On, with one flash per second (synchronized with that of the green LED on the device): power supply and communication with device present (with a device with the Alive LED option enabled)
  - On, with two quick flashes per second (not synchronized with those of the green LED on the device): power supply present, and communication with device absent (for example: for Local Bus disabled)<sup>1)</sup>
- 2 Green<sup>3)</sup> LED for signalling the physical state of the input H x1<sup>2)</sup>. The possible states are:
  - Off: floating input
  - On fixed: input short-circuited on H Cx<sup>2)</sup>
- 3 Green<sup>3)</sup> LED for signalling the physical state of the input H x2<sup>2)</sup>. The possible states are:
  - Off: floating input
  - On fixed: input short-circuited on H Cx
- 4 Green<sup>3)</sup> LED for signalling contact K x1 - K x2<sup>2)</sup>. The possible states are:
  - Off: contact open
  - On fixed: contact closed
- 5 Green<sup>3)</sup> LED for signalling the state of the contact K x3 - K x4<sup>2)</sup>. The possible states are:
  - Off: contact open
  - On fixed: contact closed
- 6 Input I x1
- 7 Conductive part of the inputs H x1 and H x2<sup>2)</sup>
- 8 Input I x2<sup>2)</sup>
- 9 Output contact pin O x1<sup>2)</sup>
- 10 Output contact pin O x2<sup>2)</sup>

1) The absence of communication is signalled immediately by the power LED, unlike the outputs which (apart from those programmed to be activated in the case of disconnection) are deactivated if the condition persists for at least 8 s  
 2) With x = 1, 2, or 3  
 3) The LED turns on and off according to the physical state of the input, without taking any account of how the Delay parameter is set.

Connections are push-in spring terminals, no tool is required.

For external wiring, cable cross section; AWG 22-16 / 0,5-1,5 mm<sup>2</sup>.

## 5.6 Using Ekip Com \_ -modules

Suitable Ekip Com \_ -modules are:

- Ekip Com Modbus RTU-OX
- Ekip Com Modbus TCP-OX
- Ekip Com Profibus DP
- Ekip Com DeviceNet
- Ekip Com Profinet
- Ekip Com EtherNet/IP
- Ekip Com IEC 61850
- Ekip Com Hub

### 5.6.1 Ekip Com Modbus RTU -module

The Ekip Com Modbus RTU is a communication accessory module, that integrates the automatic transfer switch in an industrial remote supervision and control network. The module is suitable for Level 3 and Level 4 controllers (LCD and touch control interfaces).

It can be connected to a RS-485 network with a Modbus RTU communication protocol, and allows you to:

- Connect the automatic transfer switch to the network, with dialog functionality.
- Provide the status information of the automatic transfer switch (open, closed).

For the communication lines W1 and W2, Belden type 3105A or equivalent cables must be used.



Fig. 5.11 Ekip Com Modbus RTU -module

### 5.6.1.1 Signallings

The following table illustrates the possible signals, and their meaning:

LED	Indication	Description
Power LED, green	Off	Power supply absent.
	On fixed	Power supply and communication with the device present.
	On, with two quick flashes per second	Power supply present, and communication with device absent.
RX and TX LEDs, green	Off	Modbus RTU communication not active.
	On, flashing rapidly	Modbus RTU communication active.

Table 5.6 Indication / Ekip Com Modbus RTU -module

### 5.6.1.2 Termination resistor

On the Ekip Com Modbus RTU module it is possible to activate the terminating resistance  $R_{term} = 120 \Omega$ . To enable the  $R_{term}$ , the corresponding dip-switches 1 and 2 (on the side of the module) must be positioned to ON. This option must be selected before the installation of the module. With the Ekip Com Modbus RTU modules, the dip-switches 3 and 4 of the Rpol (polarization resistance), are not used.



Fig. 5.12 Signals of Ekip Com Modbus RTU -module

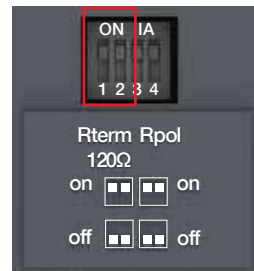

Fig. 5.13 Termination resistor; To enable the  $R_{term}$ , the dip-switches 1 and 2 must be positioned to ON. This option must be selected before the installation of the module

### 5.6.1.3 Access from the display / Ekip Com Modbus RTU –module

With modules energized the presence of the modules on the module slot activates additional menus on the display.

The following table illustrates the path for accessing the configuration parameters of the modules from the display:

Settings (*Default value)		Description
:		
Modules (Optional modules)		
Ekip Com Modbus RTU		
Serial address	1... 247, default 247*	Address to be assigned to the modules. NOTE: devices connected to the same network must have different addresses
Baudrate	9600 bit/s, 19200 bit/s*, 38400 bit/s	Data transmission speed
Physical protocol	8.E,1*, 8.O,1, 8.N,2, 8.N,1	8.E,1 = 8 data bits, 1 EVEN parity bit, 1 STOP bit 8.O,1 = 8 data bits, 1 ODD parity bit, 1 STOP bit 8.N,2 = 8 data bits, no parity bit, 2 STOP bits 8.N,1 = 8 data bits, no parity bit, 1 STOP bit
:		

Table 5.7 The path for accessing the configuration parameters of the Ekip Com Modbus RTU -module from the display

The following table illustrates the path from the display for accessing information on the module:

About	Description
:	
Modules (Optional modules)	
Ekip Com Modbus RTU	
SN	Serial number
Version	Software version
:	

Table 5.8 Information of Ekip Com Modbus RTU -module in HMI

### 5.6.2 Ekip Com Profibus DP -module

The Ekip Com Profibus DP is a communication accessory module, that integrates the automatic transfer switch in an industrial remote supervision and control network. The module is suitable Level 3 and Level 4 controllers (LCD and touch control interfaces).

It can be connected to a network RS-485 with protocol of Profibus communication, and allows of:

- Connect the automatic transfer switch as slaves to the network, with dialog functionality.
- Provide the status information of the automatic transfer switch (open, closed).

For the communication lines W5 and W6, Belden type 3079A or equivalent cables must be used.



Fig. 5.14 Ekip Com Profibus DP -module

### 5.6.2.1 Signallings

The following table illustrates the possible signals, and their meaning:

LED	Indication	Description
Power LED, green	Off	Power supply absent.
	On fixed	Power supply and communication with the device present.
	On, with two quick flashes per second	Power supply present, and communication with device absent.
RX LED, green	Off	Communication not active.
	On, fixed	Communication active.
TX LED, green	Off	Communication not active.
	On, flashing	Communication active.

Table 5.9 Indication / Ekip Com Profibus DP-module



Fig. 5.15 Signals of Ekip Com Profibus DP -module

### 5.6.2.2 Termination resistor

The Ekip Com Profibus DP modules provide the possibility to insert a  $220\ \Omega$  termination resistor on the RS-485 bus, by setting the DIP-switches Rterm (1 and 2) on the side of the modules, in position ON.

In the event of termination of the bus, a  $390\ \Omega$  pull-up or pull-down resistor must also be inserted on the lines, by setting the DIP-switches Rpol (3 and 4), in position ON.

These options must be selected before installation of the modules.

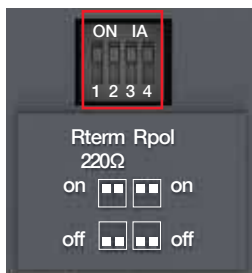

Fig. 5.16 Termination resistor; To enable the Rterm, the dip-switches 1 and 2 must be positioned to ON. When Rterm is activated, the Rpol must also be activated by turning dip-switches 3 and 4 to ON-position. These options must be selected before the installation of the modules

### 5.6.2.3 Access from the display / Ekip Com Profibus DP -module

With modules energized the presence of the modules on the module slot activates additional menus on the display.

The following table illustrates the path for accessing the configuration parameters of the modules from the display:

Settings (*Default value)	Description
:	
Modules (Optional modules)	
Ekip Com Profibus DP	
Serial address	1...125, default 125*
	Address to be assigned to the modules. IMPORTANT: devices connected to the same network must have different addresses
:	

Table 5.10 Configuration of Ekip Com Profibus DP -module in HMI

The following table illustrates the path from the display for accessing information on the module:

About	Description
:	
Modules (Optional modules)	
Ekip Com Profibus DP -module	
SN	Serial number
Version	Software version
:	

Table 5.11 Information of Ekip Com Profibus DP -module in HMI

### 5.6.3 Ekip Com DeviceNet -module

The Ekip Com DeviceNet –module is a communication accessory module, that integrates the automatic transfer switch in an industrial remote supervision and control network. The module is suitable for Level 3 and Level 4 controllers (LCD and touch control interfaces).

It can be connected to a CAN network with a DeviceNet™ communication protocol, and allows you to:

- Connect the automatic transfer switch as slaves to the network, with dialog functionality.
- Provide the status information of the automatic transfer switch (open, closed).

For the communication lines, Belden type 3084A or equivalent cables must be used.



Fig. 5.17 Ekip Com DeviceNet -module

### 5.6.3.1 Signallings

The following table illustrates the possible signals, and their meaning:

LED	Indication	Description
Power LED, green	Off	Power supply absent.
	On fixed	Power supply and communication with the device present.
	On, with two quick flashes per second	Power supply present, and communication with device absent.
Network LED, red	Off	Device off line (with red LED off) <sup>1)</sup> , or in error conditions (with red LED on).
	On, fixed	Device on line, and allocated on a master (operating condition).
	On, flashing	Device on line, but not allocated on a master (device ready for communication).
Status LED, green	Off	No error.
	On, fixed	Device in bus off, or Network Power absent condition.
	On, flashing	I/O connection (cyclic data) in timeout.

<sup>1)</sup> The device has not yet sent Duplicate ID sequence on line.

Table 5.12 Indication / Ekip Com DeviceNet -module in HMI



Fig. 5.18 Signals of Ekip Com DeviceNet -module

LCD, TOUCH

1

### 5.6.3.2 Termination resistor

The modules provide the possibility to insert a  $120\ \Omega$  termination resistor on the CAN bus, by setting the DIP-switches Rterm (1 and 2) on the side of the modules, in position ON. This option must be selected before the installation of the modules. With the Ekip Com DeviceNet - modules, the dip-switches 3 and 4 of the Rpol (polarization resistance), are not used.



#### Information

The termination resistors must never be included in the nodes. The inclusion of this capability could easily lead to a network with improper termination (impedance too high or too low), potentially causing a failure. For example the removal of a node, which includes a termination resistor, could result in a network failure.

The termination resistors must not be installed at the end of a branch (drop line), only at the two ends of the main backbone (trunk line).

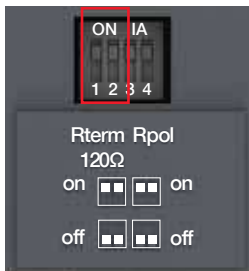

Fig. 5.19 Termination resistor; To enable the Rterm, the dip-switches 1 and 2 must be positioned to ON. This option must be selected before the installation of the module.

### 5.6.3.3 Access from the display / Ekip Com DeviceNet –module

With modules energized the presence of the modules on the module slot activates additional menus on the display.

The following table illustrates the path for accessing the configuration parameters of the modules from the display:

Settings (*Default value)	Description
:	
Modules (Optional modules)	
Ekip Com DeviceNet	
MAC address      1... 63, default 63*	Address to be assigned to the modules. IMPORTANT: devices connected to the same network must have different addresses
Baudrate          125 kbit/s, 250 kbit/s*, 500 kbit/s	Data transmission speed
:	

Table 5.13 The path for accessing the configuration parameters of the Ekip Com DeviceNet -module from the display

The following table illustrates the path from the display for accessing information on the module:

About	Description
:	
Modules (Optional modules)	
Ekip Com DeviceNet	
SN	Serial number
Version	Software version
:	

Table 5.14 Information of Ekip Com DeviceNet -module in HMI

#### 5.6.4 Ekip Com Modbus TCP -module

Ekip Com Modbus TCP is an accessory module that can function as a communication module integrating the automatic transfer switch in an industrial remote supervision and control network or as an HTTP Server. The module is suitable for Level 3 and Level 4 controllers (LCD and touch control interfaces).

As a communication module, it can be connected to an Ethernet network with the Modbus TCP communication, and allows:

- Connect the automatic transfer switch to the network, with dialog functionality.
- Provide the status information of the automatic transfer switch (open, closed).

As an HTTP Server, connected to an Ethernet network it allows read-only access to the information of the automatic transfer switch. This access is possible through a browser, inserting the IP address of the module as the URL. Once the switch has been found, a login page is opened that asks for the user password to be inserted, which is the same password to be inserted in the display in order to edit parameters.



#### Information

Since the module allows access to the data contained in the automatic transfer switch, it can only be connected to networks that meet all the necessary requirements for safety and prevention of unauthorized access (for example, the network of the control system of an installation). It is the installer's responsibility to ensure that all the necessary safety measures are adopted (for example, firewalls, and so on). The module cannot be connected directly to the Internet. It is recommended to connect it only to dedicated Ethernet networks, with the Modbus TCP communication protocol.

For the communication bus, a cable of type Cat.6 S/FTP must be used (Cat.6 with S/FTP double shielding).



Fig. 5.20 Ekip Com Modbus TCP -module

The following table illustrates the ports used by the module:

Port	Service	Notes
502/tcp	Modbus TCP	When the module is used as a Modbus TCP/IP communication module.
80/tcp	Server HTTP	When the module is used as a Server HTTP.
319/udp	IEEE 1588	When IEEE protocol 1588 is enabled
320/udp		

Table 5.15 Ports of Ekip Com Modbus TCP -module

#### 5.6.4.1 Signallings

The following table illustrates the possible signals, and their meaning:

LED	Indication	Description
Power LED, green	Off	Power supply absent.
	On fixed	Power supply and communication with the device present.
	On, with two quick flashes per second	Power supply present, and communication with device absent.
Link LED, green	Off	Connection error (signal absent).
	On, fixed	Correct connection.
Activity LED, yellow	Off	No activity on the line.
	On, flashing	Activity present on the line (in reception and/or transmission).

Table 5.16 Indication / Ekip Com Modbus TCP -module

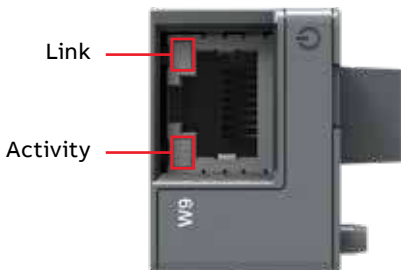

Fig. 5.21 Signals of Ekip Com Modbus TCP -module

### 5.6.4.2 Access from the display / Ekip Com Modbus TCP –module

With modules energized the presence of the modules on the module slot activates additional menus on the display:

- For setting the function and addressing of the modules.
- In order to display information on the modules.

The following table illustrates the path from the display, for setting the function and addressing of the modules:

Settings (* Default value)	Description	
:		
Modules (Optional modules)		
Ekip Com Modbus TCP		
Function	HTTP Server	HTTP Server operating mode.
	TCPModbus*	Communication module operating mode.
Force Static IP address	Off*	Dynamic IP address.
	On	Static IP address.
Static IP Address	Displayed with static IP Address enabled, it must be selected in order to insert the IP Address of the modules.	
Static Network Mask	Displayed with static IP Address enabled, it must be selected in order to insert the subnet mask of the modules.	
Static Gateway addr	Displayed with static IP Address enabled, it must be selected in the presence of multiple subnets, in order to insert the IP Address of the node to which the modules are connected.	
:		

Table 5.17 The path for setting the function and addressing of the modules of the Ekip Com Modbus TCP -module from the display

The following table illustrates the path from the display for accessing information on the module:

About	Description
:	
Modules (Optional modules)	
Ekip Com Modbus TCP	
SN	Serial number
Version	Software version
IP Address	This is the address assigned to the modules at the moment of connection to the network. It consists of four bytes (for a total of 32 bits), each of which can have value from 0 to 255. By default, allocation is dynamic. With dynamic allocation, the modules wait to receive the IP address from a DHCP server. Without a DHCP server, the modules adopt an Autoconfiguration IP Address in the range 169.254.xxx.xxx, calculated in a pseudo random manner so as to be the same at every switch-on. Alternatively, you can enable the static IP address option, which allows the IP address to be forced. In this case, you must make sure that the IP Address inserted is different to that of the other devices connected to the same network.
Network Mask	This is the subnet mask, and identifies the method to recognize the subnet to which the modules belong, with the possibility of searching for the modules within a defined set of recipients. If you enabled the option Static IP Address, you must also enter the correct Network Mask.
Gateway Address	The IP address of the node to which the module it is connected, in the presence of multiple subnets. If you enabled the Static IP Address option, you must also enter the correct Gateway Address.
TCP Client	There are three IP Addresses of the client devices connected to the modules.
MAC Address	It is the address assigned by ABB, having a OUI equal to ac:d3:64 <sup>1)</sup> .
:	

<sup>1)</sup> Organizationally Unique Identifier, formed from the first three bytes of a MAC address, and which uniquely identifies the manufacturer of an Ethernet device.

Table 5.18 Information of Ekip Com Modbus TCP -module in HMI

### 5.6.5 Ekip Com Profinet -module

The Ekip Com Profinet is a communication accessory module, that integrates the automatic transfer switch in an industrial remote supervision and control network. The module is suitable for Level 3 and Level 4 controllers (LCD and touch control interfaces) .

It can be connected to an Ethernet network with a Profinet communication protocol, and allows you to:

- Connect the automatic transfer switch to the network, with dialog functionality.
- Provide the status information of the automatic transfer switch (open, closed).



#### Information

The module can only be connected to networks that meet all the necessary requirements for safety and prevention of unauthorized access (for example, the network of the control system of an installation). It is the installer's responsibility to ensure that all the necessary safety measures are adopted (for example, firewalls, and so on). It is recommended to connect it only to dedicated Ethernet networks, with the Profinet communication protocol. The module cannot be connected to the Internet.

For the communication bus, a cable of type Cat.6 S/FTP must be used (Cat.6 with S/FTP double shielding).



Fig. 5.22 Ekip Com Profinet -module

The following table illustrates the ports used by the module:

Ethertype	Port	Service	Notes
0x88CC	-	LLDP	Link Layer Discovery Protocol
0x8892 (Profinet)	-	Profinet IO	Specific for real time communications (RT)
0x0800	34964/udp	Profinet-cm (Context Manager)	DCE/RP

Table 5.19 Ports of Ekip Com Profinet –module

### 5.6.5.1 Signallings

The following table illustrates the possible signals, and their meaning:

LED	Indication	Description
Power LED, green	Off	Power supply absent.
	On fixed	Power supply and communication with the device present.
	On, with two quick flashes per second	Power supply present, and communication with device absent.
Link LED, green	Off	Connection error (signal absent).
	On, fixed	Correct connection.
Activity LED, yellow	Off	No activity on the line.
	On, flashing	Activity present on the line (in reception and/or transmission).

Table 5.20 Indication / Ekip Com Profinet -module

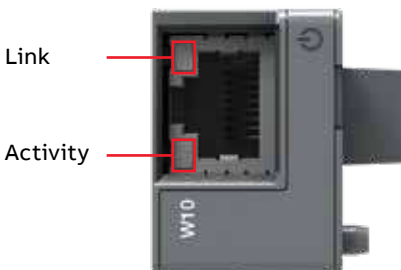

Fig. 5.23 Signals of Ekip Com Profinet -module

### 5.6.5.2 Access from the display

#### / Ekip Com Profinet -module

The following table illustrates the path from the display for accessing information on the module:

---

#### About

---

:

---

#### Modules (Optional modules)

---

##### Ekip Com Profinet -module

---

SN

Serial number

Version

Software version

MAC Address

It is the address assigned by ABB and with an OUI (Organizationally Unique Identifier, formed of the first three bytes of a MAC address, and which uniquely identifies the manufacturer of an Ethernet device) equal to ac:d3:64.

---

:

—

Table 5.21 Information of Ekip Com Profinet -module

### 5.6.6 Ekip Com EtherNet/IP -module

The Ekip Com EtherNet/IP is an accessory module that can act as a communication module integrating the automatic transfer switch in an industrial remote supervision and control network. The module is suitable for Level 3 and Level 4 controllers (LCD and touch control interfaces) .

It can be connected to an Ethernet network with a EtherNet/IP™ -communication protocol, and allows you to:

- Connect the automatic transfer switch to the network, with dialog functionality.
- Provide the status information of the automatic transfer switch (open, closed).



#### Information

Since this module allows the access to the data contained in the automatic transfer switch, it can only be connected to networks possessing all the necessary requirements for security and prevention of unauthorized access (for example, the network of the control system of an installation). It is responsibility of the installer to make sure that all the necessary security measures are adopted (for example firewalls and so on). The module cannot be connected directly to the Internet. It is recommended to connect it only to dedicated Ethernet networks using the EtherNet/IP™ -communication protocol.

For the communication bus, a cable of type Cat.6 S/FTP must be used (Cat.6 with S/FTP double shielding).

The following table illustrates the ports used by the module:

Port	Protocol	Notes
44818	TCP	Encapsulation Protocol (example: ListIdentity, UCMM, CIP Transport Class 3)
44818	UDP	Encapsulation Protocol (example: ListIdentity)
2222	UDP	CIP Transport Class 0 or 1

Table 5.22 Ports of Ekip Com EtherNet/IP -module



Fig. 5.24 Ekip Com EtherNet/IP -module

### 5.6.6.1 Signallings

The following table illustrates the possible signals, and their meaning:

LED	Indication	Description
Power LED, green	Off	Power supply absent.
	On fixed	Power supply and communication with the device present.
	On, with two quick flashes per second	Power supply present, and communication with device absent.
Link LED, green	Off	Connection error (signal absent).
	On, fixed	Correct connection.
Activity LED, yellow	Off	No activity on the line.
	On, flashing	Activity present on the line (in reception and/or transmission).

Table 5.23 Indication / Ekip Com EtherNet/IP -module

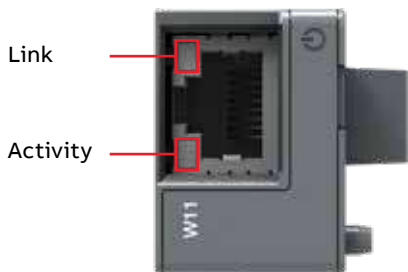

Fig. 5.25 Signals of Ekip Com EtherNet/IP -module

### 5.6.6.2 Access from the display / Ekip Com EtherNet/IP

With modules energized the presence of the modules on the module slot activates additional menus on the display:

- To set the addressing of the modules.
- In order to display information on the modules.

The following table illustrates the path from the display, for setting the function and addressing of the modules:

Settings (*Default value)	Description	
:		
Modules (Optional modules)		
Ekip Com EtherNet/IP		
Force Static IP address	Off*	Dynamic IP address.
	On	Static IP address.
Static IP Address	Displayed with static IP Address enabled, it must be selected in order to insert the IP Address of the modules.	
Static Network Mask	Displayed with static IP Address enabled, it must be selected in order to insert the subnet mask of the modules.	
Static Gateway addr	Displayed with static IP Address enabled, it must be selected in the presence of multiple subnets, in order to insert the IP Address of the node to which the modules are connected.	
:		

Table 5.24 The path for setting the function and addressing of the modules of the Ekip Com EtherNet/IP -module from the display

The following table illustrates the path from the display for accessing information on the module:

About	Description
:	
Modules (Optional modules)	
Ekip Com EtherNet/IP	
SN	Serial number
Version	Software version
IP Address	This is the address assigned to the modules at the moment of connection to the network. It consists of four bytes (for a total of 32 bits), each of which can have value from 0 to 255. By default, allocation is dynamic. With dynamic allocation, the modules wait to receive the IP address from a DHCP server. Without a DHCP server, the modules adopt an Autoconfiguration IP Address in the range 169.254.xxx.xxx, calculated in a pseudo random manner so as to be the same at every switch-on. Alternatively, you can enable the static IP address option, which allows the IP address to be forced. In this case, you must make sure that the IP Address inserted is different to that of the other devices connected to the same network.
Network Mask	This is the subnet mask, and identifies the method to recognize the subnet to which the modules belong, with the possibility of searching for the modules within a defined set of recipients. If you enabled the option Static IP Address, you must also enter the correct Network Mask.
Gateway Address	The IP address of the node to which the module it is connected, in the presence of multiple subnets. If you enabled the Static IP Address option, you must also enter the correct Gateway Address.
TCP Client	There are three IP Addresses of the client devices connected to the modules.
MAC Address	It is the address assigned by ABB, having a OUI equal to ac:d3:64 <sup>1)</sup> .
:	

<sup>1)</sup> Organizationally Unique Identifier, formed from the first three bytes of a MAC address, and which uniquely identifies the manufacturer of an Ethernet device.

Table 5.25 Information of Ekip Com EtherNet/IP -module in HMI

### 5.6.7 Ekip Com IEC 61850 -module

The Ekip Com IEC 61850 is an accessory module that can function as a communication module by integrating the automatic transfer switch in an industrial remote supervision and control network. The module is suitable for Level 3 and Level 4 controllers (LCD and touch control interfaces) .

It can be connected to an Ethernet network with a IEC 61850 -communication protocol, and allows you to:

- Connect the automatic transfer switch to the network, with dialog functionality.
- Provide the status information of the automatic transfer switch (open, closed).
- Provide vertical communication (report) towards higher-level supervision systems (SCADA) with states and measurements (re-transmitted whenever, and only if, they change with respect to the previous report).



#### Information

Since this module allows the access to the data contained in the automatic transfer switch, it can only be connected to networks possessing all the necessary requirements for security and prevention of unauthorized access (for example, the network of the control system of an installation). It is responsibility of the installer to make sure that all the necessary security measures are adopted (for example firewalls and so on). The module cannot be connected directly to the Internet. It is recommended to connect it only to dedicated Ethernet networks using the IEC 61850 -communication protocol.

For the communication bus, a cable of type Cat.6 S/FTP must be used (Cat.6 with S/FTP double shielding).



Fig. 5.26 Ekip Com IEC 61850 -module

The following table illustrates the ports used by the module:

Ethertype	Port	Protocol
0x0800 - IP	102	ISO Transport Service on top of the TCP (RFC 1006)
0x88B8	-	GOOSE Messages
0x0800 - IP	123 UDP	NTP - Network Time Protocol
0x0800 - IP	69 UDP	TFTP - Trivial File Transfer Protocol

Table 5.26 Ports of Ekip Com IEC 61850 -module

### 5.6.7.1 Signallings

The following table illustrates the possible signals, and their meaning:

LED	Indication	Description
Power LED, green	Off	Power supply absent.
	On fixed	Power supply and communication with the device present.
	On, with two quick flashes per second	Power supply present, and communication with device absent.
Link LED, green	Off	Connection error (signal absent).
	On, fixed	Correct connection.
Activity LED, yellow	Off	No activity on the line.
	On, flashing	Activity present on the line (in reception and/or transmission).

Table 5.27 Indication / Ekip Com IEC 61850 -module

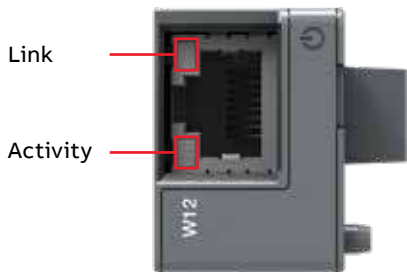

Fig. 5.27 Signals of Ekip Com IEC 61850 -module

### 5.6.7.2 Access from the display / Ekip Com IEC 61850

With modules energized the presence of the modules on the module slot activates additional menus on the display:

- To set the addressing of the modules.
- In order to display information on the modules.

The following table illustrates the path from the display, for setting the function and addressing of the modules:

Settings (*Default value)	Description	
:		
Modules (Optional modules)		
Ekip Com IEC 61850		
Force Static IP address	Off*	Dynamic IP address.
	On	Static IP address.
SNTP client abilit.	Off*	Synchronism with the SNTP clock signal disabled.
	On	Synchronism with the SNTP clock signal enabled.
Static IP Address		Displayed with static IP Address enabled, it must be selected in order to insert the IP Address of the modules.
Static Network Mask		Displayed with static IP Address enabled, it must be selected in order to insert the subnet mask of the modules.
Static Gateway addr		Displayed with static IP Address enabled, it must be selected in the presence of multiple subnets, in order to insert the IP Address of the node to which the modules are connected.
SNTP Indir. Server		Displayed with SNTP client enabled. "On" has to be selected to insert the IP address of the server with whose SNTP clock signal the modules are to be synchronised.
:		

Table 5.28 The path for setting the function and addressing of the modules of the Ekip Com IEC 61850 -module from the display

The following table illustrates the path from the display for accessing information on the module:

About	Description
:	
Modules (Optional modules)	
Ekip Com IEC 61850	
SN	Serial number
Version	Software version
IP Address	This is the address assigned to the modules at the moment of connection to the network. It consists of four bytes (for a total of 32 bits), each of which can have value from 0 to 255. By default, allocation is dynamic. With dynamic allocation, the modules wait to receive the IP address from a DHCP server. Without a DHCP server, the modules adopt an Autoconfiguration IP Address in the range 169.254.xxx.xxx, calculated in a pseudo random manner so as to be the same at every switch-on. Alternatively, you can enable the static IP address option, which allows the IP address to be forced. In this case, you must make sure that the IP Address inserted is different to that of the other devices connected to the same network.
Network Mask	This is the subnet mask, and identifies the method to recognize the subnet to which the modules belong, with the possibility of searching for the modules within a defined set of recipients. If you enabled the option Static IP Address, you must also enter the correct Network Mask.
Gateway Address	The IP address of the node to which the module it is connected, in the presence of multiple subnets. If you enabled the Static IP Address option, you must also enter the correct Gateway Address.
TCP Client	There are three IP Addresses of the client devices connected to the modules.
MAC Address	It is the address assigned by ABB, having a OUI equal to ac:d3:64 <sup>1)</sup> .
:	

<sup>1)</sup> Organizationally Unique Identifier, formed from the first three bytes of a MAC address, and which uniquely identifies the manufacturer of an Ethernet device.

Table 5.29 Information of Ekip Com IEC 61850 -module in HMI

### 5.6.8 Ekip Com Hub -module

Ekip Com Hub is a communication module for cloud-based connectivity through the ABB Ability™ Electrical Distribution Control System (EDCS).

TruONE equipped with Ekip Com Hub can establish the connection to ABB Ability for the whole low-voltage power distribution panel. This dedicated cartridge-type communication module just needs to be inserted into the TruONE and connected to the internet.

The module is suitable for Level 3 and Level 4 controllers (LCD and touch control interfaces).

The Ekip Com Modbus RTU and Ekip Com Modbus TCP modules can be configured to support Ekip Com Hub in the collection of data to send to cloud.



#### Information

It is the customer's sole responsibility to provide and continuously ensure a secure connection between Ekip Com Hub and customer network or any other network (as the case may be). The plant manager must establish and maintain appropriate measures (such as but not limited to the installation of firewalls, application of authentication measures, encryption of data, installation of antivirus programs, etc.) to protect the product, the network, the customer system and interface against any kind of security breaches, unauthorized access, interference, intrusion, loss and/or theft of data or information. ABB and its affiliates are not liable for damages and/or losses related to such security breaches, unauthorized accesses, interference, intrusion, loss and/or theft of data or information.

For the communication bus, a cable of type Cat.6 S/FTP must be used (Cat.6 with S/FTP double shielding).



Fig. 5.28 Ekip Com Hub -module

The following table illustrates the ports used by the module:

Port	Service	Notes
67/udp 68/udp	DHCP client	Client DHCP enabled as an alternative to Static address = On
443/tcp	HTTPS	Always active when module is enabled
123/udp	SNTP	Active with SNTP client enabled
53/udp	DNS	Always active

Table 5.30 Ports of Ekip Com Hub -module

### 5.6.8.1 Signallings

The following table illustrates the possible signals, and their meaning:

LED	Indication	Description
Power LED, green	Off	Power supply absent.
	On fixed	Power supply and communication with the device present.
	On, with two quick flashes per second	Power supply present, and communication with device absent.
Link LED, green	Off	Connection error (signal absent).
	On, fixed	Correct connection.
Activity LED, yellow	Off	No activity on the line.
	On, flashing	Activity present on the line (in reception and/or transmission).

Table 5.31 Indication / Ekip Com Hub -module

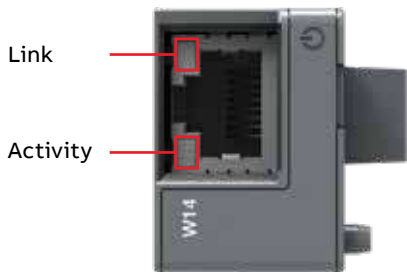

Fig. 5.29 Signals of Ekip Com Hub -module

### 5.6.8.2 Access from the display

#### / Ekip Com Hub

With modules energized the presence of the modules on the module slot activates additional menus on the display:

- To set the addressing of the modules.
- In order to display information on the modules.

The following table illustrates the path from the display, for setting the function and addressing of the modules:

Settings (*Default value)	Description	
:		
Modules (Optional modules)		
Ekip Com Hub		
Enable	Off*	Switch communication between module and server
	On	
Force Static IP address	Off*	Dynamic IP address.
	On	Static IP address.
	Se	On all the associated parameters are enabled.
Static IP Address	0.0.0.0*	Enables the static IP to be selected.
Network Mask Static	0.0.0.0*	Enables the subnet mask to be selected.
Static Gateway addr	0.0.0.0*	When there are several subnets, enables the IP address of the node to which the module is connected to be selected.
SNTP Client Enabled	Off*	Enables the SNTP protocol for distribution of the clock and synchronization signal to be enabled.
	On	
SNTP Server Address	0.0.0.0*	Enables the network server that supplies the SNTP to be set.
Password	---	Code required to register module on cloud.
Remote firmware update		Enables the firmware of the module to be updated.
	OFF Automatic*	
	Enable	To configure firmware download.
	Automatic	To automate module update.
:		

Table 5.32 The path for setting the function and addressing of the modules of the Ekip Com Hub -module from the display

The following table illustrates the path from the display for accessing information on the module:

About	Description
:	
Modules (Optional modules)	
Ekip Com Hub	
SN	Serial number
Version	Software version
IP Address	Address of the module, assigned to the module by a DHCP server at the time of connection to the network in the case of configuration with a dynamic IP, or can be set via the menu in the event of a static IP. NOTE: without a DHCP server, the module automatically adopts a random IP address within the 169.254.xxx.xxx range.
Network Mask	Subnet mask; identifies the method for recognizing the subnet to which the modules belong and enables modules to be searched for within a defined set of recipients.
Gateway Address	IP address of the node to which the module is connected, in the presence of several subnets.
MAC Address	Address assigned by ABB, with OUI (Organizationally Unique Identifier) equal to ac:d3:64, which uniquely identifies the manufacturer of an Ethernet device.
:	
—	

Table 5.33 Information of Ekip Com Hub -module in HMI

## 6. Troubleshooting

### 6.1 Alarms



LCD



Touch

Message	Fault	Action
Locked, Alarm LED on	Lock input activated	Unlock
Switch not in AUTO mode, Alarm LED on	Slide switch is in handle or lock position	Turn slide switch into the AUTO position
Phases crossed	Phase rotation of sources 1 and 2 are different	Connect the phases of both sources in the same order
S1 undervoltage	Voltage of source 1 is under the threshold level set in parameter "Drop-out voltage, lower threshold"	Check the correlation between power source and device configuration
S1 overvoltage	Voltage of source 1 is over the threshold level set in parameter "Drop-out voltage, upper threshold"	Check the correlation between power source and device configuration
S1 phase missing	One or two phases of source 1 are missing	Check the power source and connections
S1 unbalance	Phases of source 1 are not symmetric	Check the power source
S1 phase rotation	Phase rotation of source 1 is different from the value of parameter "Phase sequence"	Connect the phases according to the configuration
S1 invalid frequency	Frequency of source 1 is out of range set in parameters "Drop-out frequency, upper threshold" and "Drop-out frequency, lower threshold"	Check the correlation between power source and device configuration
S2 undervoltage	Voltage of source 2 is under the threshold level set in parameter "Drop-out voltage, lower threshold"	Check the correlation between power source and device configuration
S2 overvoltage	Voltage of source 2 is over the threshold level set in parameter "Drop-out voltage, upper threshold"	Check the correlation between power source and device configuration
S2 phase missing	One or two phases of source 2 are missing	Check the power source and connections
S2 unbalance	Phases of source 2 are not symmetric	Check the power source
S2 phase rotation	Phase rotation of source 2 is different from the value of parameter "Phase sequence"	Connect the phases according to the configuration
Frequency Difference	Frequency difference of voltage sources is greater than 3 Hz while in-phase monitor is on	Alarm is active and transfer operations disabled as long as the frequency difference is above the accepted level

Table 6.1 Alarms-list in level 3 and 4, LCD and touch control interfaces

Message	Fault	Action
S2 invalid frequency	Frequency of source 2 is out of range set in parameters "Drop-out frequency, upper threshold" and "Drop-out frequency, lower threshold"	Check the correlation between power source and device configuration
High current alarm	Measured current is higher than ten times the nominal value	Alarm is active and transfer operations disabled as long as the high current status remains
Open I failure, Alarm LED blinking	Switch transfer from position I to O or II failed	Reset alarm by pressing Auto button or via menu page Operation / Alarm Reset
Close I failure, Alarm LED blinking	Switch transfer to position I failed	Reset alarm by pressing Auto button or via menu page Operation / Alarm Reset
Open II failure, Alarm LED blinking	Switch transfer from position II to O or I failed	Reset alarm by pressing Auto button or via menu page Operation / Alarm Reset
Close II failure, Alarm LED blinking	Switch transfer to position II failed	Reset alarm by pressing Auto button or via menu page Operation / Alarm Reset
Switch position alarm, Alarm LED on	More than one switch position indication inputs are activated	Switch service needed
Pole temperature alarm	Measured pole temperature is too high	Switch service needed
Contact wear alarm	Switch contact wear is near the limit that requires maintenance	Switch service needed
Local bus	Communication between HMI and switch controller is off	Check connection
Ethernet disconnected	Ethernet module not connected	Check connection
Fire Fighting	Fire fighting input activated	Alarm is active and disables transfer operations as long as the input is active
Control Voltage Failure	Control voltage dropped during switch control	Check power source
Control Voltage Low	Switch control voltage is below the minimum	Check power source
Configuration Error	Invalid configuration	Check parameter values
IEC 61850 Error	IEC 61850 failure	Check configuration file
Ekip Com Hub Alarm	Ekip Com Hub failure	Check configuration

Table 6.1 Alarms-list in level 3 and 4, LCD and touch control interfaces

## 6.2 Warnings



LCD



Touch

Message	Reason
S1 and S2 not in sync	Voltage sources are not synchronized
Voltage Not Calibrated	Calibration data in power module is invalid or unavailable
Current Not Calibrated	Calibration data in current measurement module is invalid or unavailable
Pole temperature warning	Measured pole temperature is near the alarm level
Control Retry	Failed transfer sequence retry activated
Auto Control Disabled	Device is in manual operating mode
Local Bus	Module heartbeat error
Configuration	Configuration session ports are open
RTC capacitor charging	Real time clock is not yet operational, date & time setting is disabled as long as this warning is active. RTC capacitor is charged from source voltage (not AUX) and takes about 10 minutes

Table 6.2 Warnings-list in level 3 and 4, LCD and touch control interfaces

## 6.3 Information



LCD



Touch

Message	Description
Invalid Date	Date not set
Test on Load	Test on load sequence active
Test off Load	Test off load sequence active
Alarm/Product Availability	Digital output function activated
In Position I	Digital output function activated
In Position O	Digital output function activated
In Position II	Digital output function activated
Pre-transfer Signal	Digital output function activated
Source 1 Available	Digital output function activated
Source 2 Available	Digital output function activated
Load Shed	Digital output function activated
Emergency Stop	Digital input function activated
Remote Test on Load	Digital input function activated
Remote Test off Load	Digital input function activated
Inhibit Auto Mode	Digital input function activated
Manual Retransfer	Digital input function activated
Priority S1	Digital input function activated
Priority S2	Digital input function activated
Inhibit Transfer	Digital input function activated
Bypass Running Delays	Digital input function activated
Remote Control to S1	Digital input function activated
Remote Control to Off	Digital input function activated
Remote Control to S2	Digital input function activated
Alarm Reset	Digital input function activated
Manual-Auto Mode	Digital input function activated

Table 6.3 Info statements in level 3 and 4, LCD and touch control interfaces

## 7. Technical data

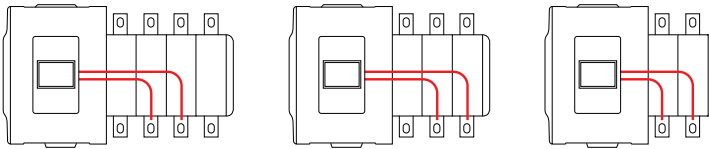
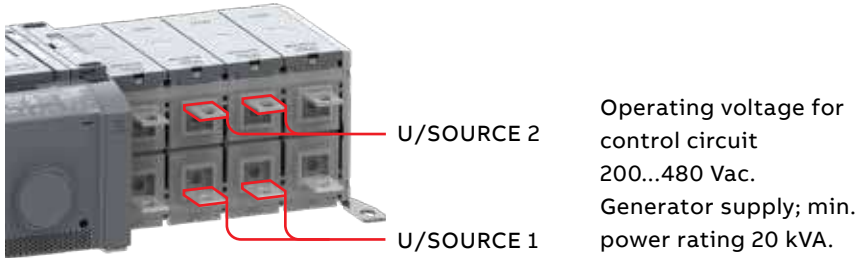
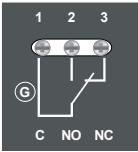
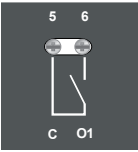
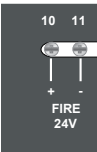

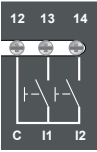
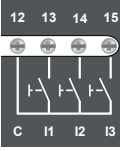

Fig. 7.1 Power supply for control circuit, in figure type OX\_B (source on bottom)

Automatic transfer switch, power circuit	Value	
Rated operational voltage U	200...480 Vac	
Rated frequency f	50 / 60 Hz	
Rated impulse withstand voltage $U_{imp}$	12 / 8 kV	
Operating times	See Table 7.2	
Automatic transfer switch, control circuit	Value	Remark
Voltage supply	200...480 Vac	Integrated, see Fig. 7.1
Operating voltage range	±20%	
Voltage measurement accuracy		
Rated frequency f	50 / 60 Hz	
Operating frequency range, Level 2	±10%	Level 2 = HMI with DIP-switches
Operating frequency range, Level 3 and 4	±20%	Level 3 = HMI with LCD screen, Level 4 = HMI with touch screen
Frequency measurement accuracy		
Rated impulse withstand voltage $U_{imp}$	6 kV	

Automatic transfer switch, I/O contacts		Cabling	Rating / Remark
Generator start/stop	Cable size:	0.5...2.5 mm <sup>2</sup> 24...14 AWG	Stripping length; 6,5 mm, 0,255"
	Common, voltage supply	1	5 A@250 Vac (AC-1), 5 A@30 Vdc
	Generator start/stop NO	2	
	Generator start/stop NC	3	
Output relay features	Cable size:	0.5...2.5 mm <sup>2</sup> 24...14 AWG	
Common, voltage supply		5	5 A@250 Vac (AC-1), 5 A@30 Vdc
	Level 2		Level 2 = HMI with DIP-switches
	Alarm/Product available	6	
	Level 3 and 4		Level 3 = HMI with LCD screen, Level 4 = HMI with touch screen
	Programmable output (default; Alarm/Product available)	6	
Fire Fighting applications	Cable size:	0.5...2.5 mm <sup>2</sup> 24...14 AWG	Only in OXB_-types, delayed transition, I – O – II or II – O – I
	Fire fighting input 24 Vdc (+)	10	SELV
	Fire fighting input 24 Vdc (-)	11	
Input contact features	Cable size:	0.5...2.5 mm <sup>2</sup> 24...14 AWG	Do not connect to any power supply
Common input		12	24 Vdc 5 mA
	Level 2		Level 2 = HMI with DIP-switches
	Emergency stop	13	Only in OXB_-types, delayed transition, I – O – II or II – O – I
	Level 3		Level 3 = HMI with LCD screen
	Programmable input (default; Emergency stop)	13	
	Programmable input (default; Remote test on load)	14	Only in OXB_-types, delayed transition, I – O – II or II – O – I
	Level 4		Level 4 = HMI with touch screen
	Programmable input (default; Emergency stop)	13	
	Programmable input (default; Remote test on load)	14	
	Programmable input (default; Remote test off load)	15	Only in OXB_-types, delayed transition, I – O – II or II – O – I

Environmental	Value
Environments category	E
EMC environment	A and B
Operating temperature (without derating)	-20... +40 °C
Operating temperature (with derating)	-25... +70 °C
Transportation and storage temperature	-40... +70 °C
Altitude (without derating)	Up to 2000 m

Table 7.1 General technical data of automatic transfer switch

Type	Voltage $U_e$ [Vac]	Nominal current* $I_n$ [A]	Operating time* = current duration I-0, 0-I, 0-II, II-0 [ms]	Operating transfer time* AUTO mode I-II or II-I [ms]	Contact transfer time* I-II or II-I [ms]
OXA30...260U_	200...480	37	-	< 500	< 50
AXB200...400E_	200...480	37	< 110	< 500	< 50
OXA400...600U_	200...480	40	-	< 500	< 50
AXB500...800E_	200...480	40	< 130	< 500	< 50
OXA800...1200U_	200...480	40	-	< 500	< 50
AXB1000...1600E_	200...480	40	< 130	< 500	< 50

\* Under nominal conditions

Table 7.2 Specified technical data of operating times









Type	$I_q$ / 500 V			$I_{peak}$ [kA]	$I^2t$ kA <sup>2</sup> s
OX_30...250_	Iq 100 kA rms.		OFA_400 A gG	35.2	803
			OFA_400 A aM	39	1030
OX_260...OX_400E_	Iq 50 kA rms.		ABB T5L630_	29.8	2084
			OFA_630 A gG	56.2	2790
OX_260...OX_400E_	Iq 100 kA rms.		OFA_630 A aM	56.8	3670
			ABB T6L630_	52.0	13778
OX_400U	Iq 100 kA rms.		OFA_800 A gG	68	7311
			OFA_800 A aM	64.2	4800
OX_400U	Iq 50 kA rms.		ABB T6L630_	53.1	14860
			OFA_1000 A gG	67.7	5235
OX_500...800E_	Iq 100 kA rms.		OFA_1000 A aM	77.1	7155
			ABB T6L1000_	57.2	16800
OX_800U-1600_	Iq 100 kA rms.		OFA_1600 A gG	80.8	9900
			OFA_1250 A aM	91.3	11600
OX_800U-1600_	Iq 85 kA rms.		ABB T7L1600_	111.6	44900

Table 7.3 Rated conditional short-circuit values

# 7.1 Circuit diagrams

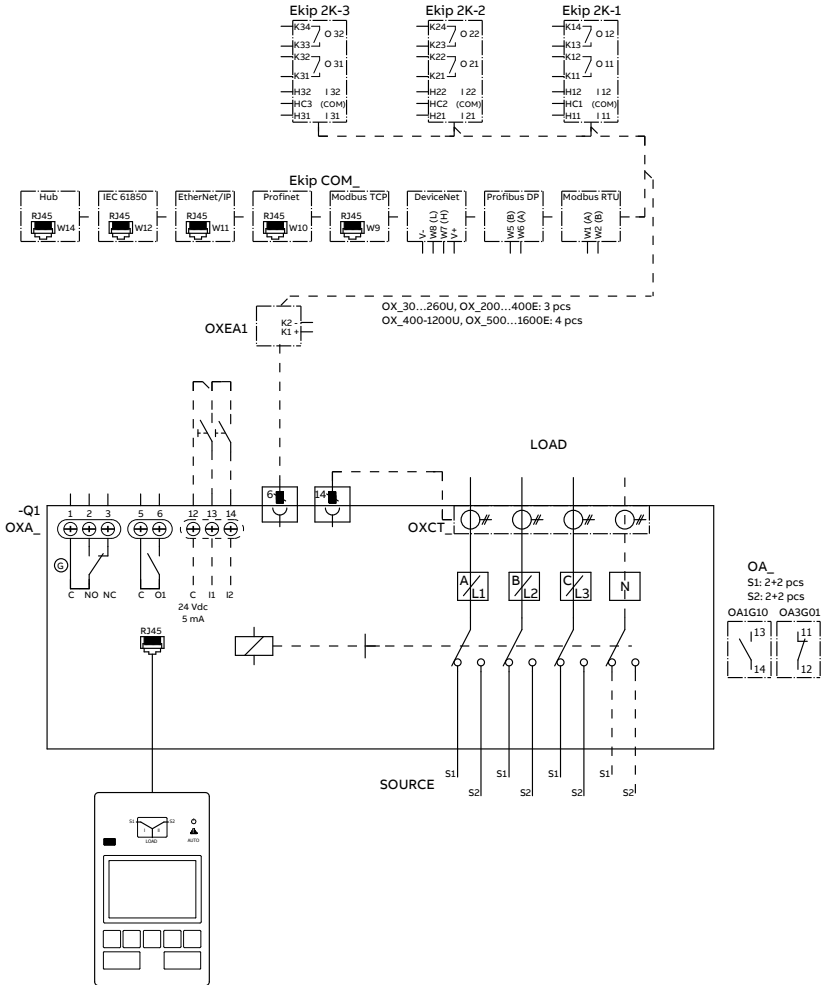

Fig. 7.2 Circuit diagram, OXA\_B

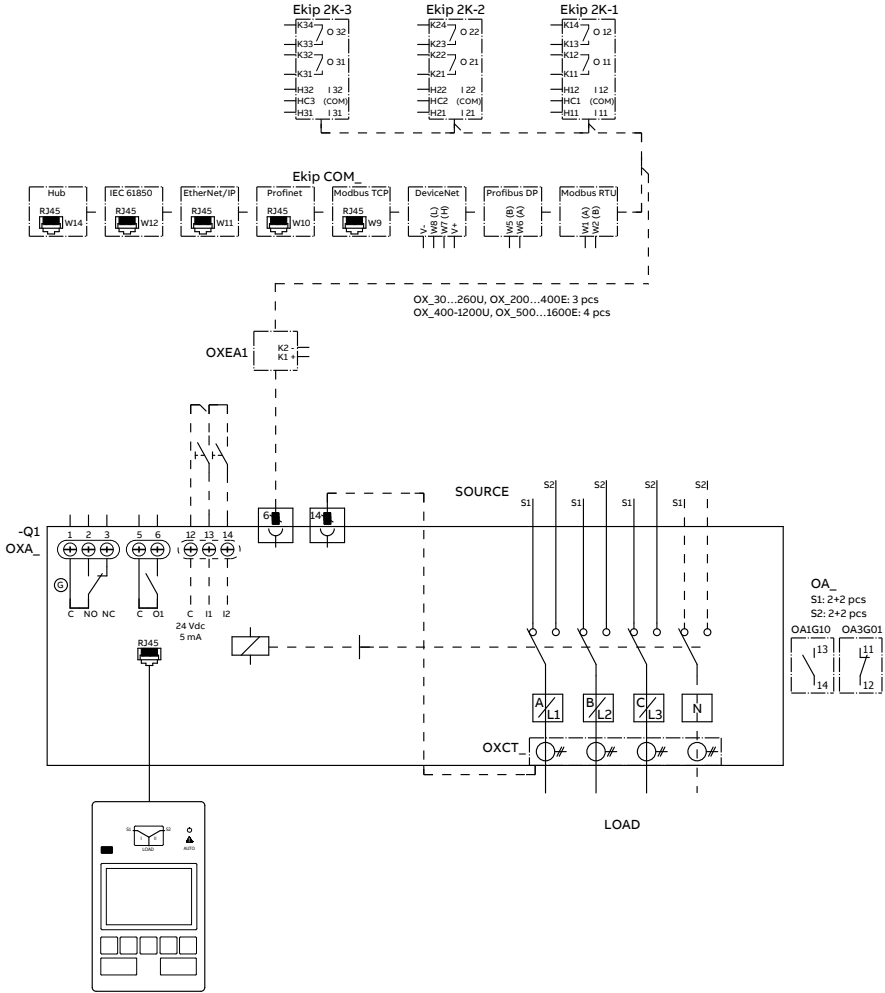

Fig. 7.3 Circuit diagram, OXA\_T

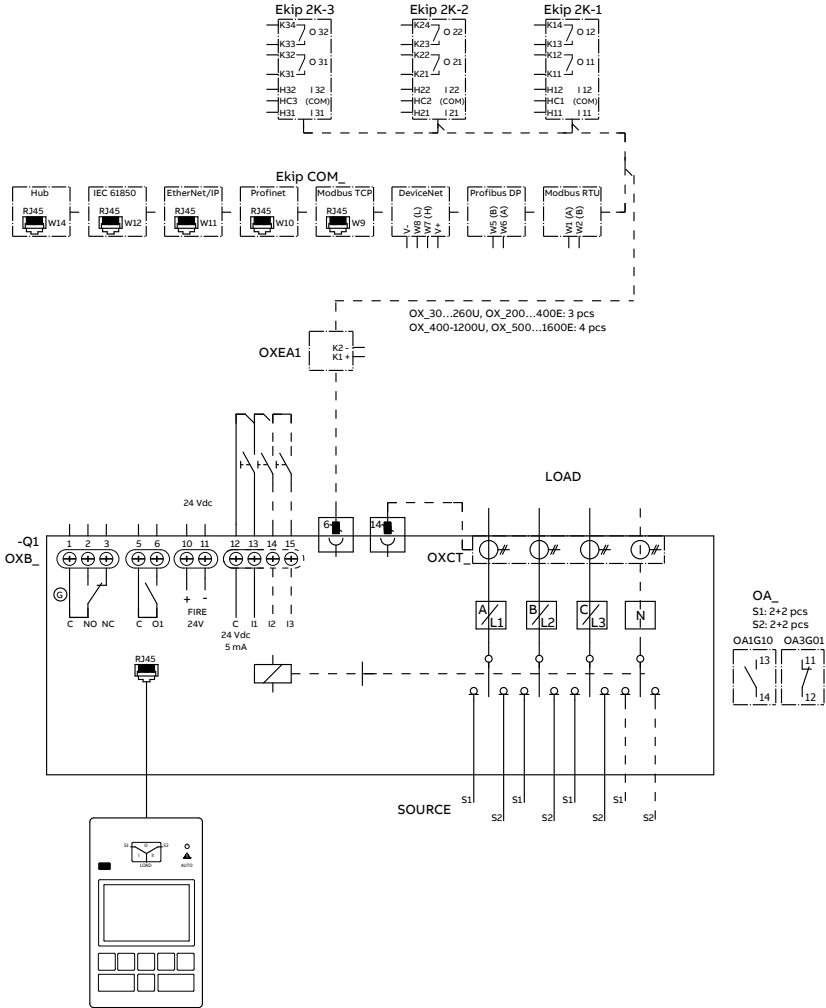

Fig. 7.4 Circuit diagram, OXB\_B

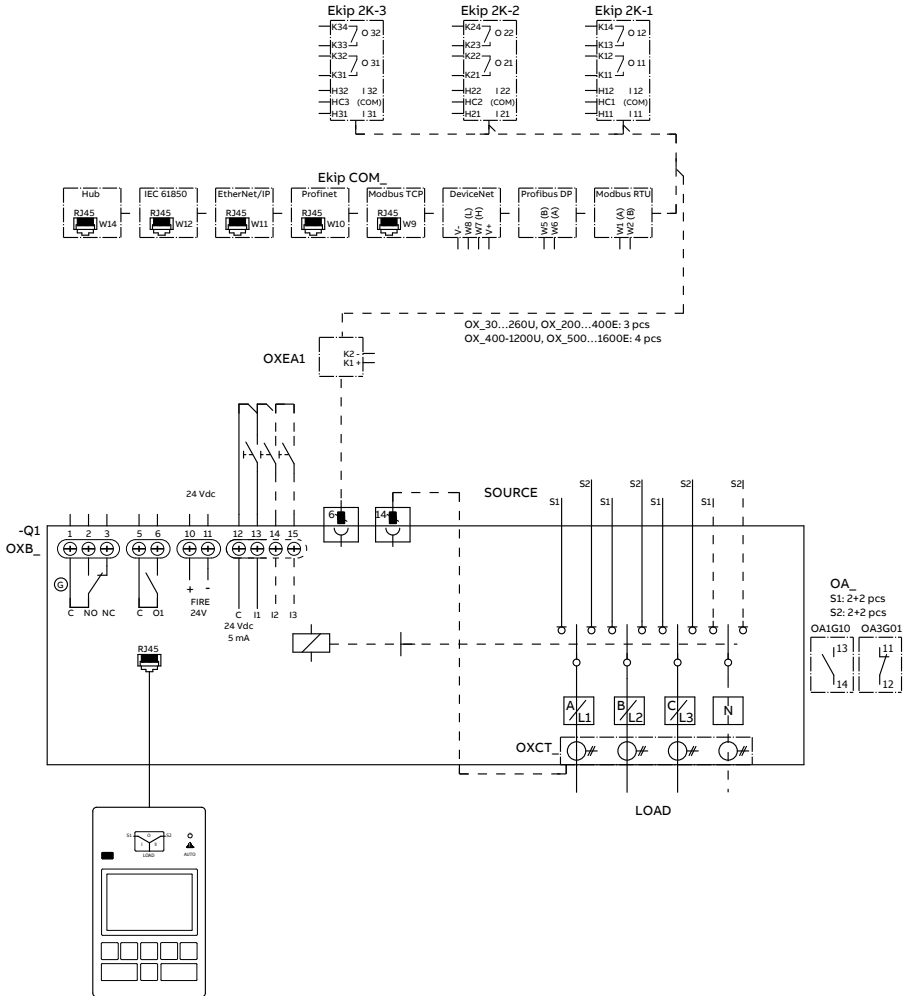

Fig. 7.5 Circuit diagram, OXB\_T

---

# Installation instruction

## Automatic transfer switches

<b>8. Installation</b>	<b>125</b>
8.1 Mounting the OX30...1600 automatic transfer switch	126
8.1.1 Drilling hole distances and labeling	126
8.1.2 Protection against direct contact	127
8.2 Wiring	128
8.2.1 Wiring of OX_30...800 / cable lugs	128
8.2.2 Wiring of OX_800U...1600 / busbar connections and cable lugs	129
8.2.3 Lug assembly	131
8.2.4 Phase barriers	133
8.3 Clearances per UL1008	133
8.4 Mounting of the handle and HMI	134
8.4.1 Manual mode; mounting of the handle to operation position	134
8.4.2 Automatic mode; mounting of the handle to standby slot	135
8.4.3 Mounting of the HMI	135

<b>9. Mounting of accessories</b>	<b>137</b>
9.1 Terminal shrouds	137
9.2 Phase barriers	138
9.3 Auxiliary contact blocks	139
9.4 Sensor module	140
9.5 Auxiliary power supply and Ekip -modules	141
9.6 HMI protective cover	143
9.7 Terminal busbar	145
<b>10. Dimension drawings</b>	<b>146</b>

---

## 8. Installation

Before mounting the product, please, check the product identification from the product identification label, which is located on the front panel under the control interface unit (HMI). This label indicates the product model (type number), some important technical data information, minimum enclosure size, suitable wire information, etc.

## 8.1 Mounting the OX30...1600 automatic transfer switch

### 8.1.1 Drilling hole distances and labeling

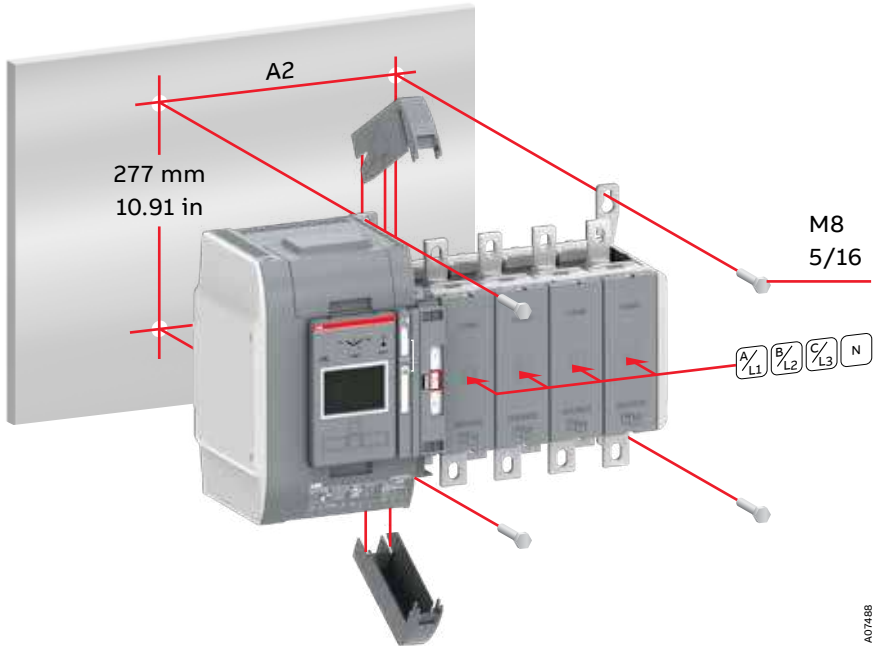

Fig. 8.1 Automatic transfer switches, drilling hole distances / screw-mounting, [mm/in] and attachment of the self-adhesive labels

Automatic transfer switch	A2 [mm / in]		
	2-pole	3-pole	4-pole
OX_30...250_	120 / 4.72	165 / 6.50	210 / 8.27
OX_260...400_	160 / 6.30	225 / 8.86	290 / 11.42
OX_500...800_	160 / 6.30	225 / 8.86	290 / 11.42
OX_800U...1600_	-	375 / 14.77	490 / 19.30

Table 8.1 Automatic transfer switches, drilling

### 8.1.2 Protection against direct contact

For protection against direct contact you can use the terminal shrouds when possible or a plexiglass mounted over the product.



Fig. 8.2 On top: Protection against direct contact with terminal shrouds.

On bottom: Protection against direct contact with a plexiglass mounted over the product

## 8.2 Wiring

### 8.2.1 Wiring of OX\_30...800 / cable lugs

Automatic transfer switch	Bolt size	Tightening torque T [Nm / lb.in]
OX_30...250_	M8	15...22 / 133...195
OX_260...400_	M10	30...44 / 266...390
OX_500...800_	M12	50...75 / 443...664

Table 8.2 OX\_30...800\_/ bolt sizes and tightening torques

Automatic transfer switch	Max. distance from switch frame to nearest cable support	
	SOURCE	LOAD
	[mm / in]	[mm / in]
OX_30...250_	300 / 11.8	150 / 5.9
OX_260...400_	300 / 11.8	150 / 5.9
OX_500...800_	300 / 11.8	150 / 5.9

Table 8.3 OX\_30...800\_/ cable support with breaker or fuses (SCPD)

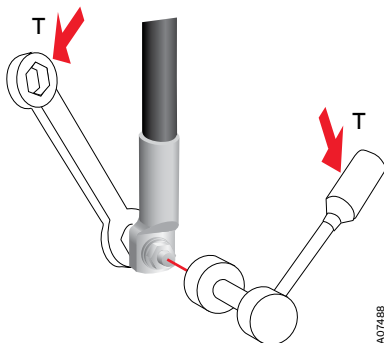

A07488

Fig. 8.3 Wiring, the tightening torques, see the tables 8.2 and 8.3



#### Hazardous voltage

Only an authorised electrician may perform the electrical installation and maintenance of OX\_ automatic transfer switches. Do not attempt any installation or maintenance actions when an OX\_ automatic transfer switch is connected to the electrical mains. Before starting work, make sure that the switch is de-energised.

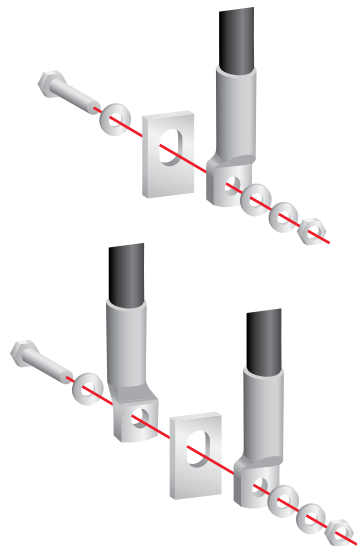

A07488

Fig. 8.4 OX\_30...800, wiring by cable lugs

### 8.2.2 Wiring of OX\_800U...1600 / busbar connections and cable lugs

Automatic transfer switch	Bolt size	Tightening torque [Nm / lb.in]
OX_800U...1600_	M12	50...75 / 443...664

Table 8.4 OX\_800U...1600\_/ bolt size and tightening torque



**General warning**

The cable lug must be pushed into the oval hole of the terminal as close as possible to the switch pole.

Automatic transfer switch	Max. distance from switch frame to nearest cable/busbar support	
	SOURCE [mm / in]	LOAD [mm / in]
OX_500...800_	300 / 11.8	150 / 5.9
- Busbar	225 / 8.9	150 / 5.9
OX_800U...1600_	400 / 15.7	200 / 7.8

Table 8.5 OX\_500...1600\_/ cable/busbar support with breaker or fuses (SCPD)

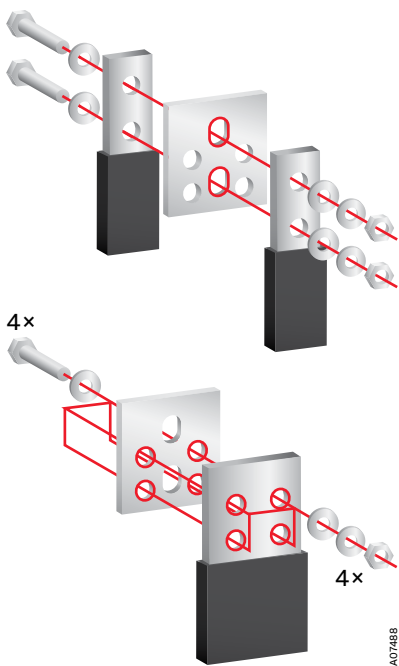

Fig. 8.5 OX\_800U...1600, busbar connection

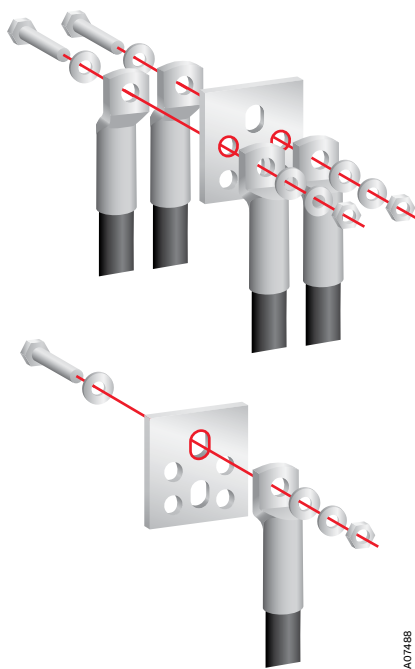

Fig. 8.6 OX\_800U...1600, wiring / cable lugs

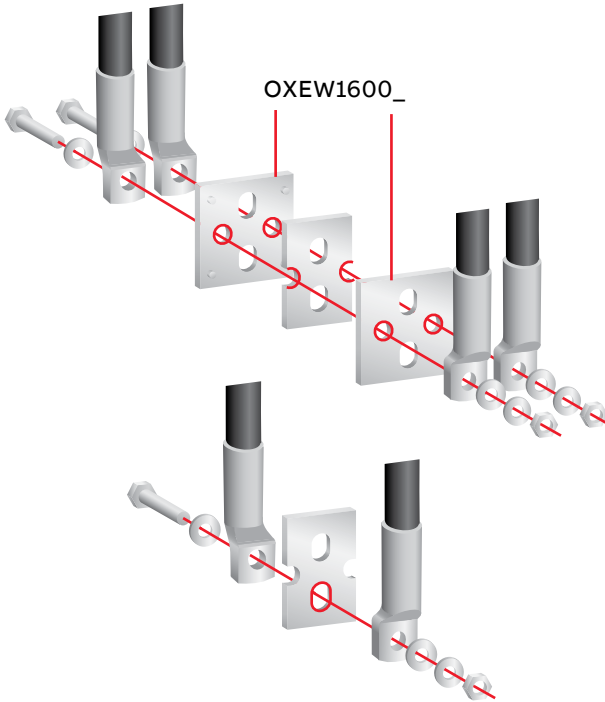

Fig. 8.7 Wiring with cable lugs in automatic transfer switches OX\_800U...3200: For load side terminals the busbars OXEW1600\_ are needed to mount on both sides of the switch terminal for connecting the cable lugs. Tightening torque and bolt size, see the table 8.4

### 8.2.3 Lug assembly



Fig. 8.8 Lug assembly



#### General warning

Torquing lugs with the improper tool and/or to a torque value exceeding the defined parameters may result in damage to the switch.

Lug assembly	Lug assembly/ Fixing screws [pcs]	Lug assembly/ Mounting torque [lb.in / Nm]	Wire/ Size	Wire/ Tightening torque [lb.in / Nm]
OZXA-100, OZXA-24	1	OZXA-100: 124 / 14 OZXA-24: 132 / 14.9	14...10 AWG	35 / 4
			8 AWG	40 / 4.5
			6...4 AWG	45 / 5.1
			3...2/0 AWG	50 / 5.6
OZXA-200	1	132 / 14.9		200 / 22.6
OZXA-25	1	177 / 20		275 / 31.1
OZXA-400	1	228 / 25.8		375 / 42.4
OZXA-26	1	228 / 25.8		375 / 42.4
OZXA-800E, OZXA-800S	1	480 / 54.2		500 / 56.5
OZXA-800L	1	480 / 54.2		500 / 56.5
OZXA-30, OZXA-1200	2	443 / 50.1		500 / 56.5

Table 8.6 Lug assembly, mounting information

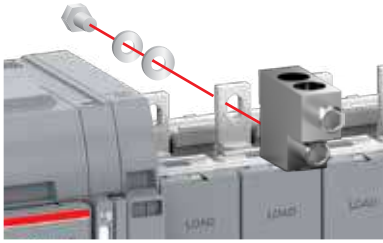

OZXA-100...400, OZXA-800E, OZXA-800S

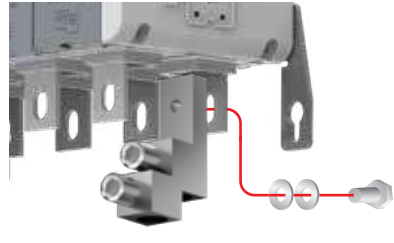

OZXA-24...26, OZXA-800L

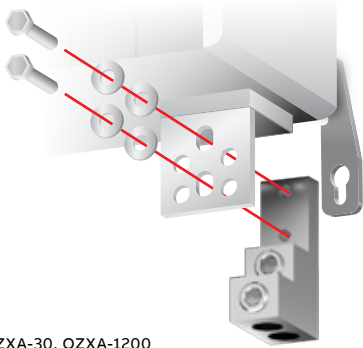

OZXA-30, OZXA-1200

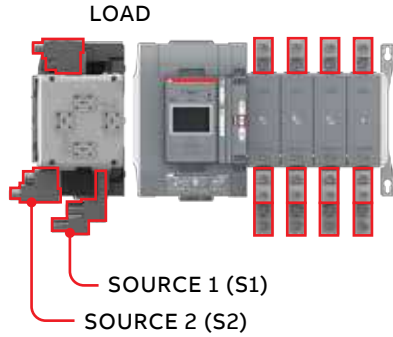

A07489

Automatic transfer switch	Lug assembly		
	LOAD	SOURCE S2	SOURCE S1
OX_30...100_	OZXA-100	OZXA-100	OZXA-24
OX_30...200_	OZXA-200	OZXA-200	OZXA-25
OX_260/400_	OZXA-400	OZXA-400	OZXA-26
OX_600_	OZXA-800E	OZXA-800E	OZXA-800L
OX_800_	OZXA-800S / OZXA-800E	OZXA-800S / OZXA-800E	OZXA-30
OX_1000/1200_	OZXA-1200	2 x OZXA-800S (_E)	OZXA-1200

Table 8.7 OX\_30...1200\_ / suitable lug assembly

Automatic transfer switch	Max. distance from switch frame to nearest cable/busbar support	
	SOURCE [in / mm]	LOAD [in / mm]
OX_30...200_	11.8 / 300	5.9 / 150
OX_260_	11.8 / 300	5.9 / 150
OX_400_	11.8 / 300	5.9 / 150
OX_600_	11.8 / 300	5.9 / 150
OX_800_	15.7 / 400	7.8 / 200
OX_1200_	15.7 / 400	7.8 / 200

Table 8.8 OX\_30...1200\_ / cable/busbar support with breaker or fuses (SCPD)

### 8.2.4 Phase barriers

Phase barriers must be used between the LOAD side terminals of TruONE automatic transfers switches with switch types OX\_400U/500E...1200U/1600E. These switch types include the phase barriers for LOAD side from the factory. Additional phase barriers to be used for the SOURCE side terminals must be ordered separately when needed.

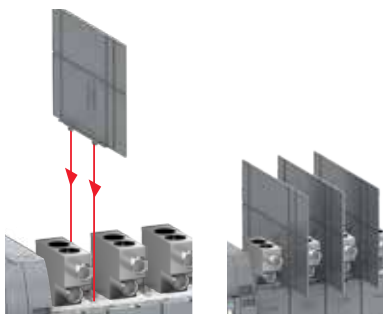

A07491

Fig. 8.9 Mounting of phase barriers.

## 8.3 Clearances per UL1008

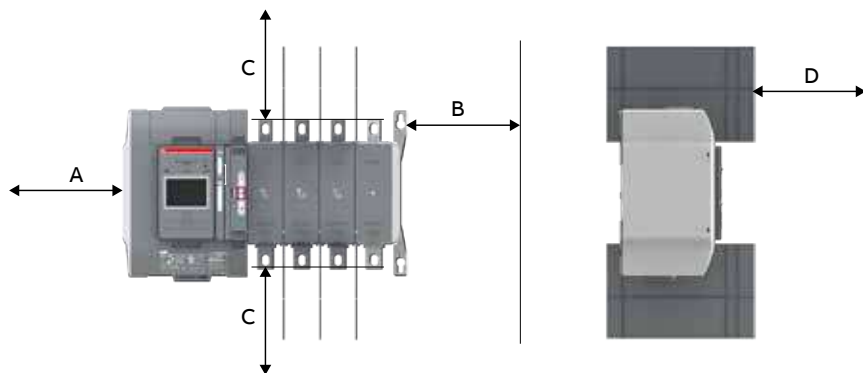

A07489

Fig. 8.10 UL standard switches, clearances per UL1008

Size (Current)	A [in /mm]	B [in /mm]	D [in /mm]	C
OX_30...200U_	1 / 26	0.5 / 13	0.5 / 13	According to the
OX_260...400U_	1 / 26	0.5 / 13	0.5 / 13	UL1008 standard
OX_600U_	1 / 26	0.5 / 13	0.5 / 13	
OX_800U_...OX_1200U_	1 / 26	0.5 / 13	0.5 / 13	

### Minimum enclosure size or equivalent volume

Size (Current)	Width [in /mm]	Height [in /mm]	Depth [in /mm]
OX_30...200U_	23.6 / 600	31.5 / 800	11.8 / 300
OX_260...400U_	23.6 / 600	31.5 / 800	11.8 / 300
OX_600U_	23.6 / 600	31.5 / 800	11.8 / 300
OX_800U_...OX_1200U_	31.5 / 800	39.4 / 1000	11.8 / 300

## 8.4 Mounting of the handle and HMI

For more information of operating, position indication and the selection of the operating mode, see the Chapter 3.2 Operating and locking.

More information, see animation: Manual and automatic operation - TruONE® ATS (<https://youtu.be/bosvSPVi2sM>).



### General warning

Verify the condition of power source prior to manually transferring. Manual operation may result in out-of-phase transfer when both sources are energized.

### 8.4.1 Manual mode; mounting of the handle to operation position

Manual mode

1

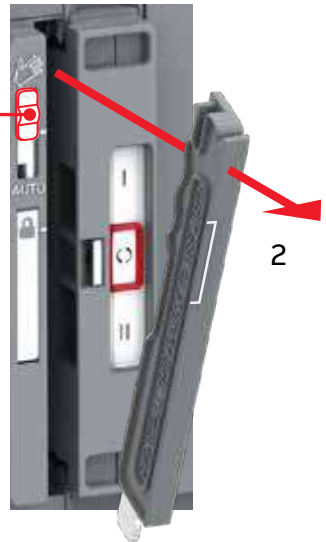

2



3

Fig. 8.11 Mounting the handle to the operating position; turn the slide switch to the Manual mode (Hand), lift the handle and place it to the operating position

### 8.4.2 Automatic mode; mounting of the handle to standby slot

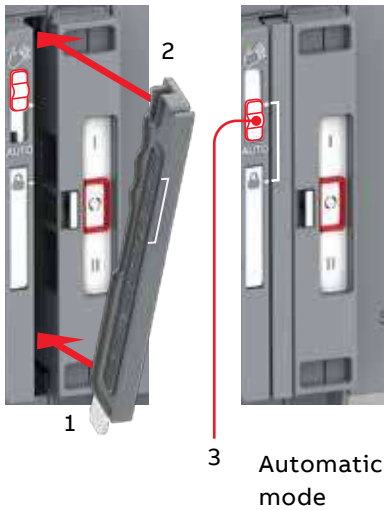

#### Information

When the slide switch is moved to the AUTO position, the automatic control mode is activated after a three second delay.

More information, see animation:  
Installation of ATS in the panel and HMI on door - TruONE® ATS (<https://youtu.be/PnvjhCVWQak>).



Fig. 8.12 Before moving to the Automatic mode, the operating handle must set to its place. When the handle is in its place properly, the slide switch will move to the Locking mode automatically and the switch is allowed to be padlocked, if needed. From the Locking mode the slide switch can be moved to the Automatic mode

### 8.4.3 Mounting of the HMI

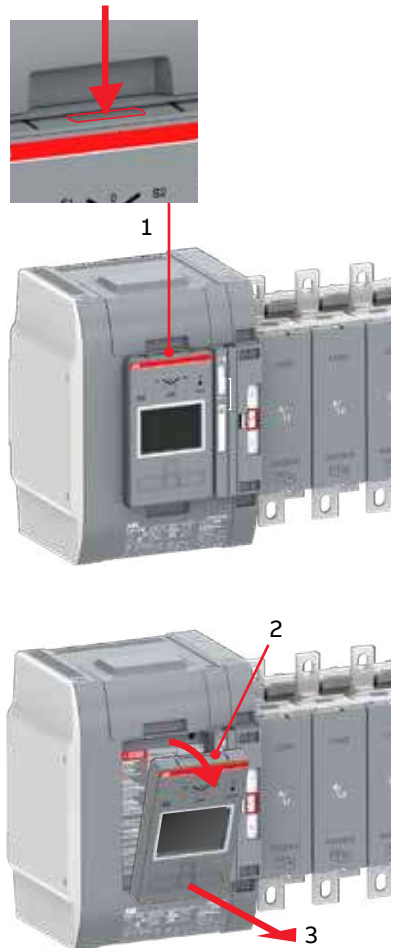

Fig. 8.13 Removing the HMI from the switch



OR



Max. 3 m,  
HMI (RJ45) cable

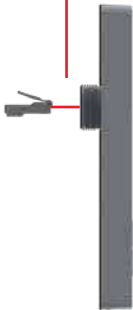

Tightening  
torque of a nut  
3.5 Nm / 31 lb.in

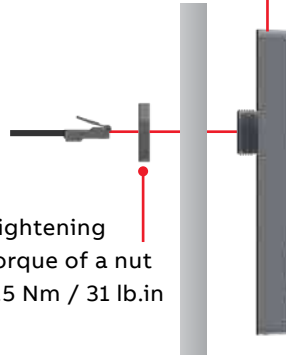

A07490

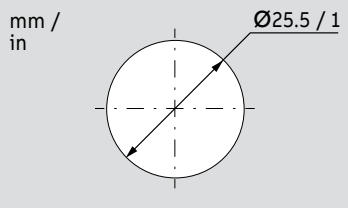

Fig. 8.14 HMI can be mounted on the switch or the door, door drilling. HMI protective cover available as accessory, type OXEC21, provides protection against accidental contact, see Chapter 9, Mounting of accessories

## 9. Mounting of accessories

More information, see animation:  
Installation of accessories - TruONE® ATS  
(<https://youtu.be/qV2KolV38GY>).



### 9.1 Terminal shrouds

Automatic transfer switch	Suitable terminal shroud G= Grey	
	Short type	Long type
OX_30...250	OXES250G1S	OXES250G1L
OX_260...800	OXES800G1S	OXES800G1L
OX_800U...1600	-	OXES1600G1L

Table 9.1 Terminal shrouds, type OXES\_

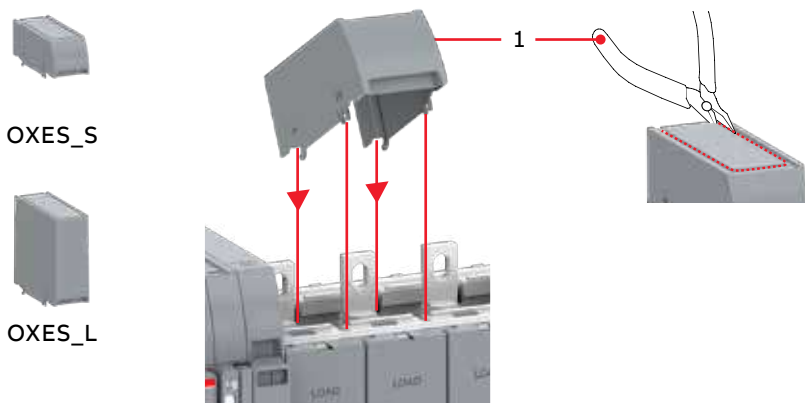

Fig. 9.1 Mounting of the terminal shrouds to the automatic transfer switches, TruONE® ATS

## 9.2 Phase barriers

Phase barriers must be used to maintain a clearance of 1 inch on the automatic transfer switch types.

These are not required with the standard UL mechanical lug offering, but may be

required when alternate connections do not have anti-rotation features, or when alternate connections reduce over-air clearance between phase conductors to less than 1 inch.

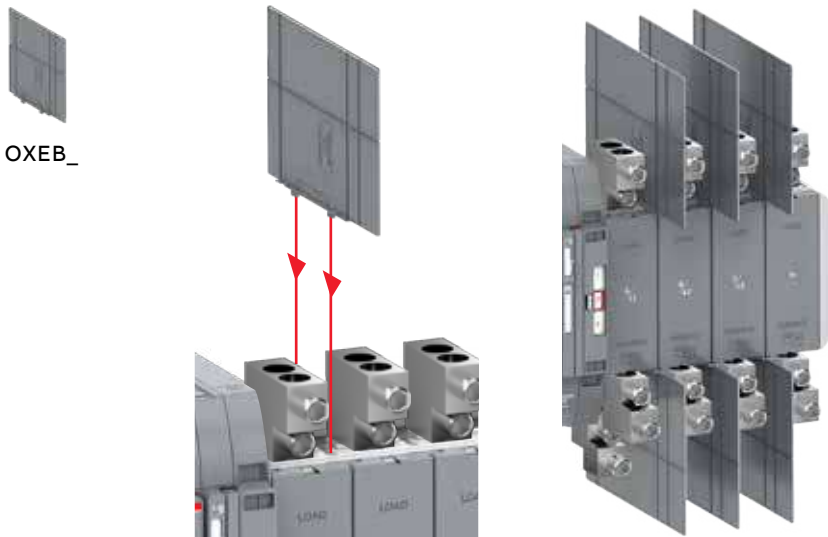

A07491

Fig. 9.2 Mounting of phase barriers, type OXEB\_

### 9.3 Auxiliary contact blocks

Position	OA1G10	OA3G01
<b>SOURCE 1 (S1), max 2+2</b>		
I		
O		
II		
<b>SOURCE 2 (S2), max 2+2</b>		
I		
O		
II		

Table 9.2 Contact positions

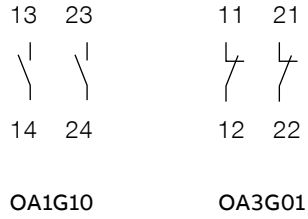

Fig. 9.4 Labels for contact numbering

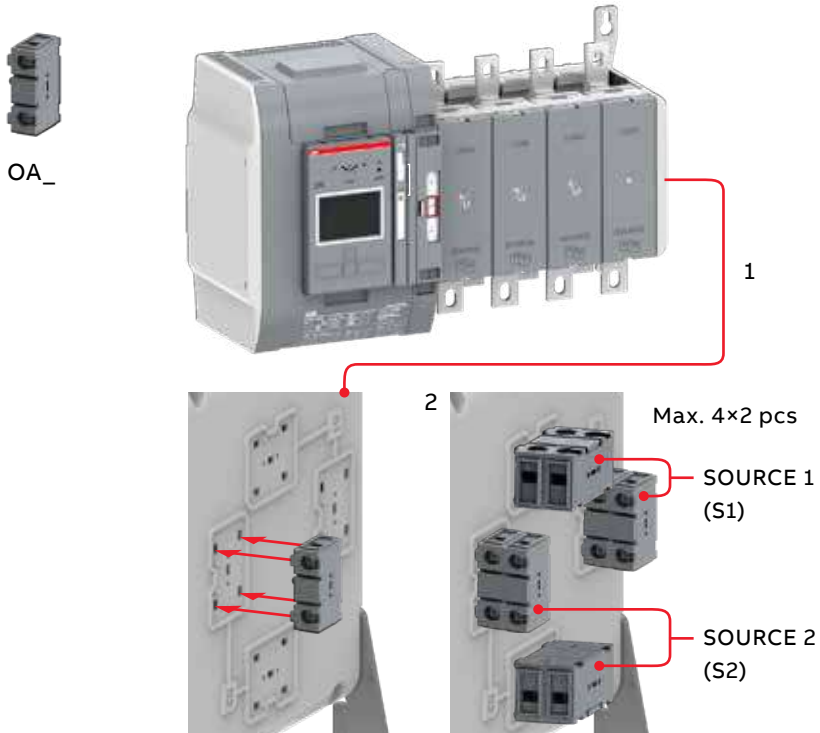

Fig. 9.3 Mounting of the auxiliary contact blocks, type OA\_

## 9.4 Sensor module

Sensor module, type OXCT\_, is used for energy and temperature measurement. There are available modules for 2, 3 and 4-pole switches and for different switch sizes.

Switch size	Nominal current of OXCT_ [A]
OX_30...250	250
OX_260...800	800
OX_800U...1600	1600

Table 9.3 Nominal currents

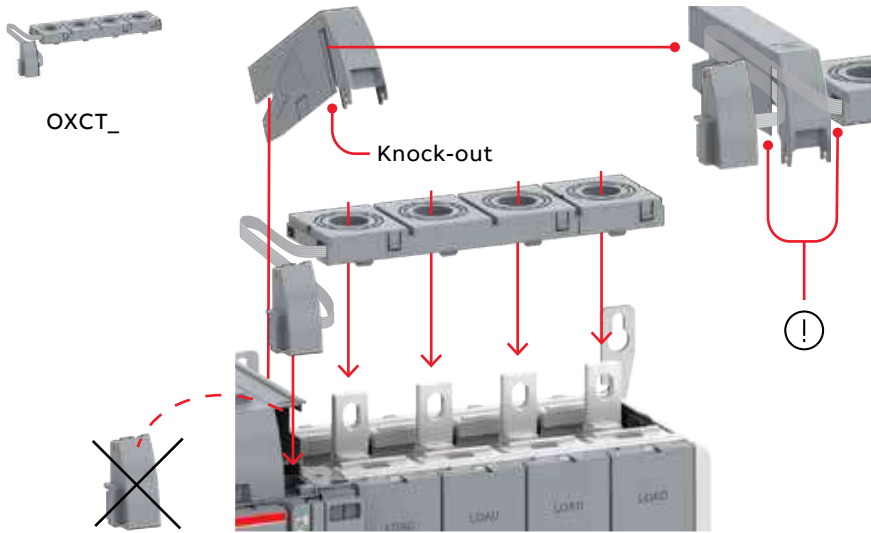

Fig. 9.5 Mounting of the sensor module, type OXCT\_

---

## 9.5 Auxiliary power supply and Ekip -modules

Automatic transfer switches OX\_ can be equipped with Ekip-modules. Ekip-modules are mounted with a auxiliary power supply module, OXEA1. Suitable Ekip-modules are: Signalling and connectivity modules. For more information, see Chapter 5, Electronic accessories.

Max. Ekip-modules:

- OX\_30...260U, OX\_200...400E: 3 pcs
- OX\_400-1200U, OX\_500...1600E: 4pcs



Fig. 9.6 Mounting of the auxiliary power supply module OXEA1 and Ekip –modules

A07491

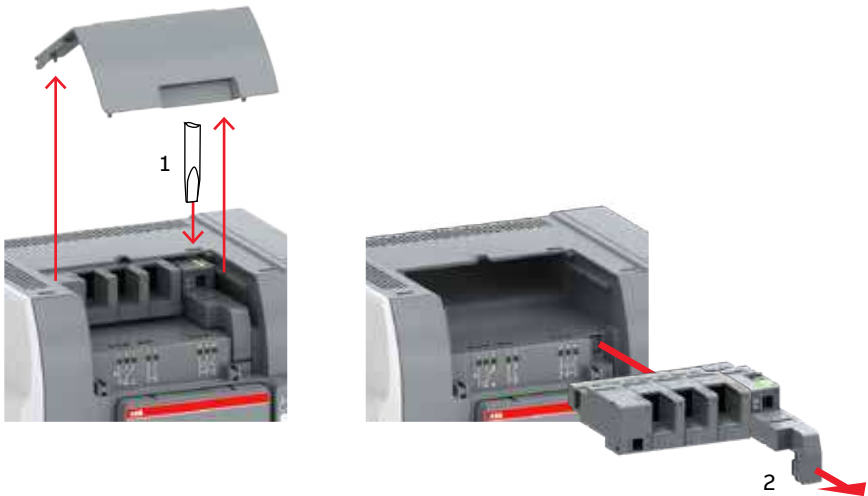

Fig. 9.7 Removing the auxiliary power supply module OXEA1 and Ekip –modules from the automatic transfer switch

A07491

## 9.6 HMI protective cover

HMI protective cover is available as accessory, type OXEC21, provides protection against accidental contact.

Fig. 9.8 Mounting of HMI protective cover, type OXEC21, door drilling, see next page

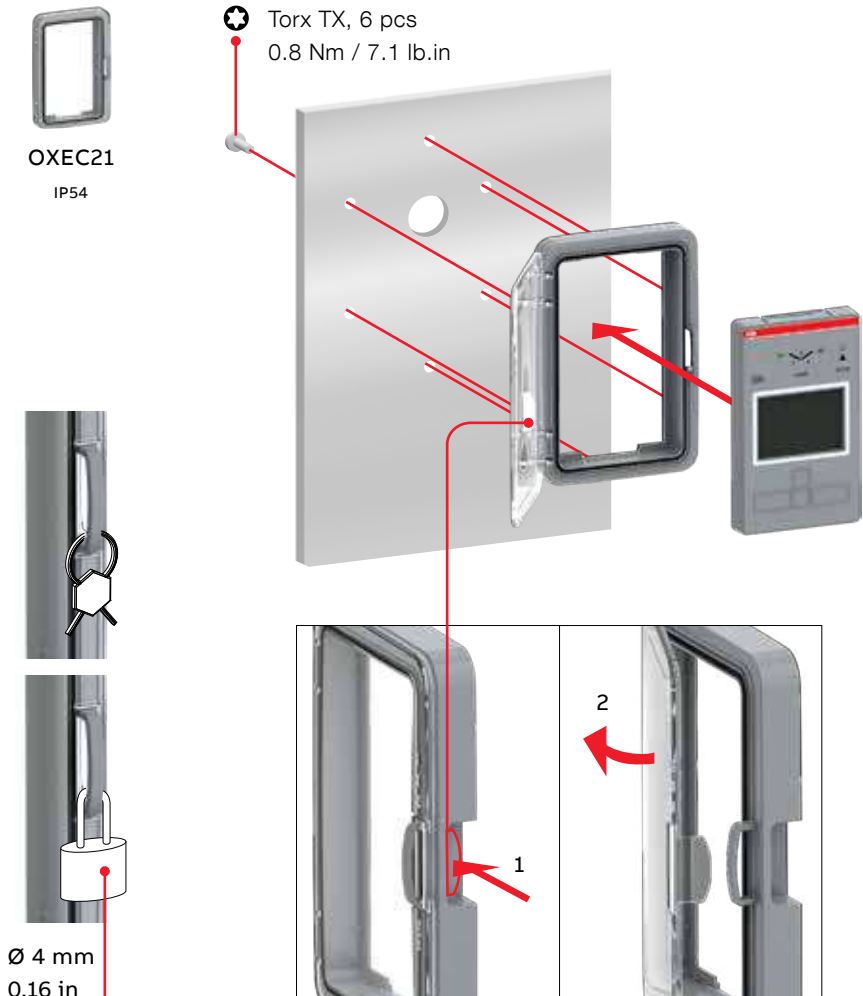

mm / in

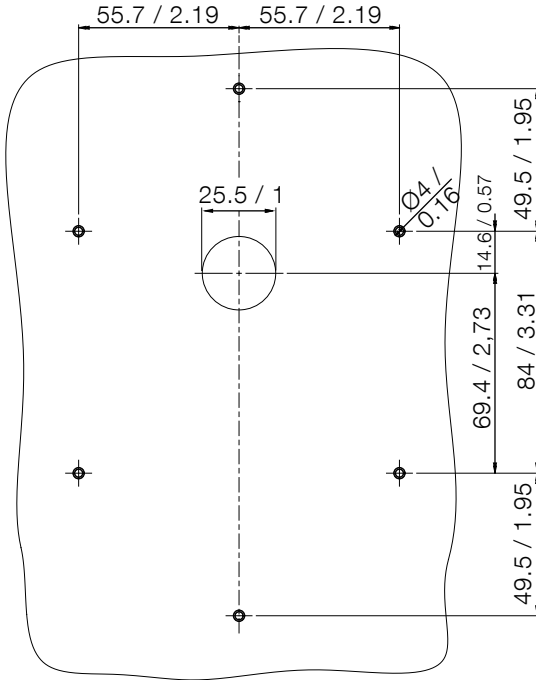

A07491

Fig. 9.9 Door drilling of the HMI protective cover

## 9.7 Terminal busbar

Terminal busbar, type OXEW1600\_, is needed for automatic transfer switches OX\_800U...3200A on LOAD side terminals, when wiring is done with cable lugs. It is needed to mount on both sides of the terminal for connecting the cable lug.

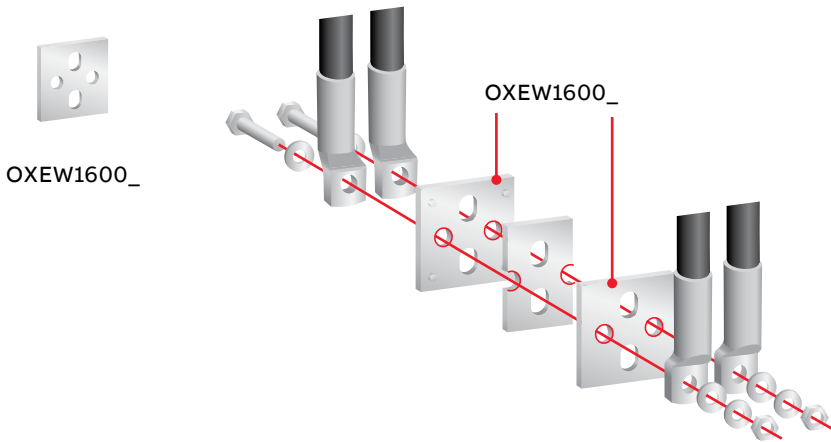

A07491

Fig. 9.10 For OX\_800U...3200 is needed the terminal busbars, type OXEW1600\_, for connecting the cable lug. The busbars have to be mount on both sides of the load side terminals. Tightening torque and bolt size, see the table 8.4

# 10. Dimension drawings

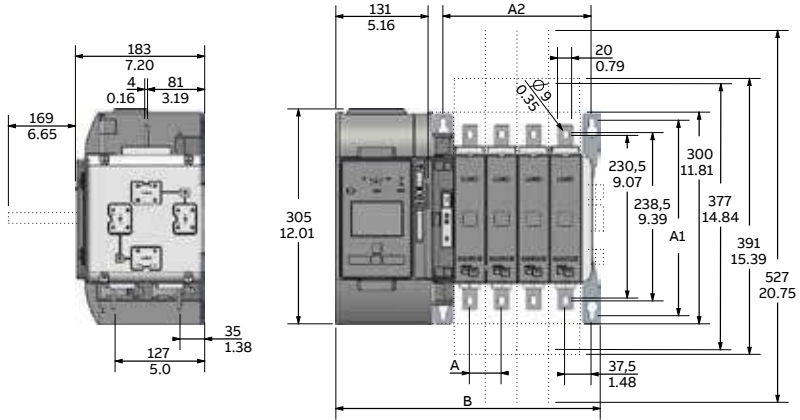

Fig. 10.1 OX\_30...250\_B

<b>OX_30-250_</b>				
<b>No. of poles</b>	<b>2</b>	<b>3</b>	<b>4</b>	
A	45/1.77	45/1.77	45/1.77	
A1	277/10.91	277/10.91	277/10.91	
A2	120/4.72	165/6.50	210/8.27	
B	285/11.22	330/12.99	375/14.76	

Note: B dimension, recommended to leave 2 cm/1" free space on the left side (for removing the mechanism)

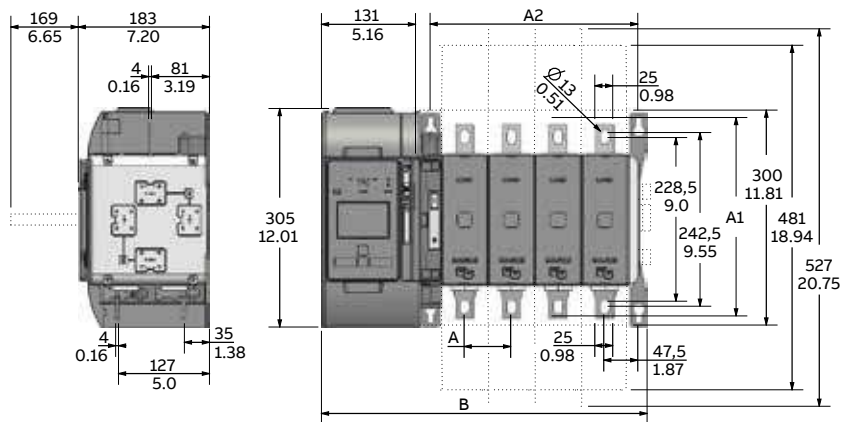

Fig. 10.2 OX\_260...400\_B

**OX\_260\_400**

No. of poles	2	3	4
A	65/2.56	65/2.56	65/2.56
A1	277/10.91	277/10.91	277/10.91
A2	160/6.30	225/8.86	290/11.42
B	325/12.80	390/15.35	455/17.91

Note: B dimension, recommended to leave 2 cm/1" free space on the left side (for removing the mechanism)

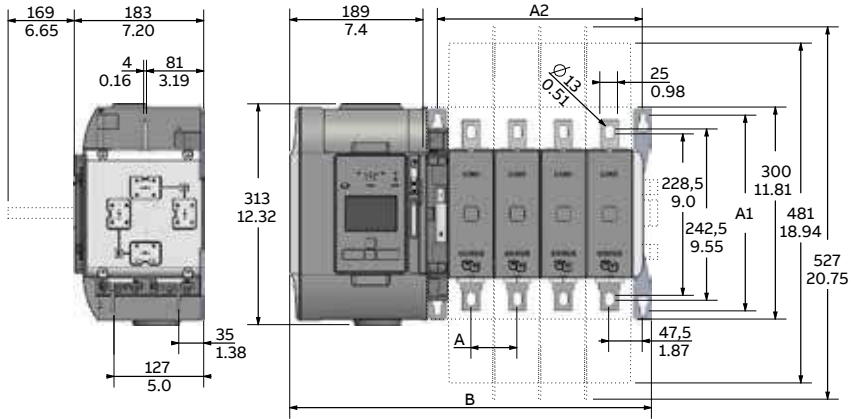

Fig. 10.3 OX\_400U\_B

<b>OX_400U_B</b>			
<b>No. of poles</b>	<b>2</b>	<b>3</b>	<b>4</b>
A	65/2.56	65/2.56	65/2.56
A1	277/10.91	277/10.91	277/10.91
A2	160/6.30	225/8.86	290/11.42
B	382/15.04	447/17.60	512/20.16

Note: B dimension, recommended to leave 2 cm/1" free space on the left side (for removing the mechanism)

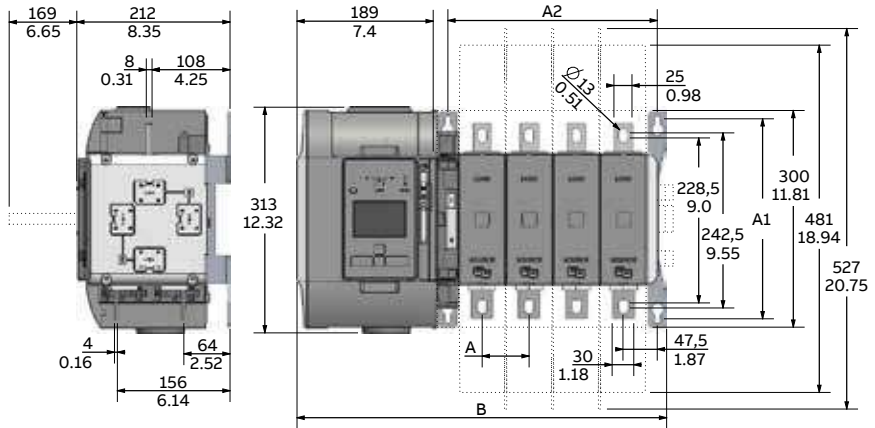

Fig. 10.4 OX\_500...800\_B

<b>OX_500-800_</b>				
<b>No. of poles</b>	<b>2</b>	<b>3</b>	<b>4</b>	
A	65/2.56	65/2.56	65/2.56	
A1	277/10.91	277/10.91	277/10.91	
A2	160/6.30	225/8.86	290/11.42	
B	382/15.04	447/17.60	512/20.16	

Note: B dimension, recommended to leave 2 cm/1" free space on the left side (for removing the mechanism)

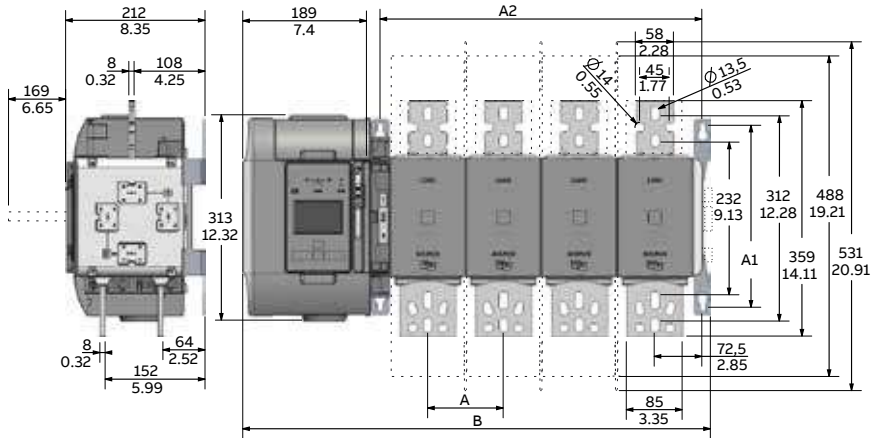

Fig. 10.5 OX\_800U...1600\_B

<b>OX_800U-1600</b>		
<b>No. of poles</b>	<b>3</b>	<b>4</b>
A	115/4.53	115/4.53
A1	227/10.91	227/10.91
A2	375/14.77	490/19.30
B	597/23.51	712/28.04

Note: B dimension, recommended to leave 2 cm/1" free space on the left side (for removing the mechanism)



# Notes

A series of 20 horizontal dotted lines for writing notes.



# Notes

A series of 20 horizontal dotted lines for writing notes.



# Notes

A series of horizontal dotted lines for writing notes.



# Notes

A series of horizontal dotted lines for writing notes.



# Notes

A series of 20 horizontal dotted lines spanning the width of the page, intended for writing notes.



# Notes

A series of horizontal dotted lines for writing notes.



# Notes

A series of 20 horizontal dotted lines for writing notes.

**Additional information**

We reserve the right to make technical changes or modify the contents of this document without prior notice. With regard to purchase orders, the agreed particulars shall prevail. ABB does not accept any responsibility whatsoever for potential errors or possible lack of information in this document.

We reserve all rights in this document and in the subject matter and illustrations contained therein. Any reproduction, disclosure to third parties or utilization of its contents – in whole or in parts – is forbidden without prior written consent of ABB.



<b>BG</b>	Внимание! Опасно напрежение! Да се монтира само от лице с електротехническа квалификация.
<b>FR</b>	Avertissement! Tension électrique dangereuse! Installation uniquement par des personnes qualifiées en électrotechnique.
<b>MT</b>	Twissija! Vultaġġ perikoluż! Għandu jiġi installat biss minn persuna b'kompetenza elettroteknika.
<b>HR</b>	Upozorenje! Opasan napon! Postavljati smije samo elektrotehnički stručnjak.
<b>DE</b>	Warnung! Gefährliche Spannung! Installation nur durch elektrotechnische Fachkraft.
<b>PL</b>	Ostrzeżenie! Niebezpieczne napięcie! Instalacji może dokonać wyłącznie osoba z fachową wiedzą w dziedzinie elektrotechniki.
<b>CZ</b>	Varování! Nebezpečné napětí! Montáž smí provádět výhradně elektrotechnik!
<b>EL</b>	Προειδοποίηση! Υψηλή τάση! Η εγκατάσταση πρέπει να γίνεται μόνο από εξειδικευμένους ηλεκτροτεχνικούς.
<b>PT</b>	Aviso! Tensão perigosa! A instalação só deve ser realizada por um electricista especializado.
<b>DA</b>	Advarsel! Farlig elektrisk spænding! Installation må kun foretages af personer med elektroteknisk ekspertise.
<b>HU</b>	Figyelmeztetés! Veszélyes feszültség! Csak elektrotechnikai tapasztalattal rendelkező szakember helyezheti üzembe.
<b>RO</b>	Avvertizare! Nevărnă periculoasă! Instalarea trebuie efectuată numai de către o persoană cu experiență în electrotehnică.
<b>NL</b>	Waarschuwing! Gevaarlijke spanning! Mag alleen geïnstalleerd worden door een deskundige elektrotechnicus.
<b>IE</b>	Rabhadh! Voltas guaiseach! Ba chóir do dhuine ag a bhfuil saineolas leictreicniúil, agus an té sin a mháin, é seo a shuiteáil.
<b>SK</b>	Varovanie! Nebezpečné napätie! Montáž môže vykonávať iba skúsený elektrotechnik.
<b>EN</b>	Warning! Hazardous voltage! Installation by person with electrotechnical expertise only.
<b>IT</b>	Avvertenza! Tensione pericolosa! Fare installare solo da un elettricista qualificato.
<b>SL</b>	Opozorilo! Nevarna napetost! Vgradnjo lahko opravi le oseba z elektrotehničnim strokovnim znanjem.
<b>ET</b>	Hoiatus! Ohtlik pinge. Paigaldada võib ainult elektrotehnika-alane ekspert.
<b>LV</b>	Uzmanību! Bīstami - elektrība! Montāžas darbus drīkst veikt tikai personas, kurām ir atbilstošas elektrotehnikās zināšanas.
<b>ES</b>	¡Advertencia! ¡Tensión peligrosa! La instalación deberá ser realizada únicamente por electricistas especializados.
<b>FI</b>	Varoitus! Vaarallinen jännite! Asennuksen voi tehdä vain sähköalan ammattihenkilö.
<b>LT</b>	Dėmesio! Pavojinga įtampa! Dirbti leidžiama tik elektrotechniko patirties turintiems asmenims.
<b>SE</b>	Varning! Farlig spänning! Installation får endast utföras av en elektriker.
<b>CN</b>	警告！电压危险！只能由专业电工进行安装。
<b>RU</b>	Осторожно! Опасное напряжение! Монтаж должен выполняться только специалистом-электриком.



---

## Contact us

### **ABB Oy**

P.O. Box 622  
FI-65101 Vaasa  
Finland

**[abb.com/lowvoltage](http://abb.com/lowvoltage)**



**[www.abb.com/truone](http://www.abb.com/truone)**