

## Информационен лист | Номер на артикул: 2016-1207

2-conductor ground terminal block; 16 mm<sup>2</sup>; suitable for Ex e II applications;  
side and center marking; for DIN-rail 35 x 15 and 35 x 7.5; Push-in CAGE  
CLAMP®; 16,00 mm<sup>2</sup>; green-yellow

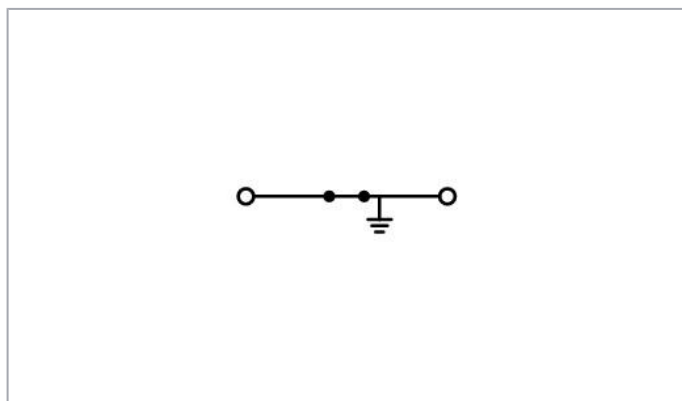

[www.wago.com/2016-1207](http://www.wago.com/2016-1207)

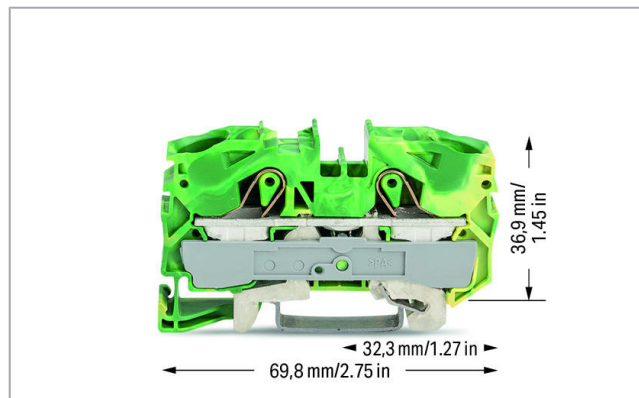
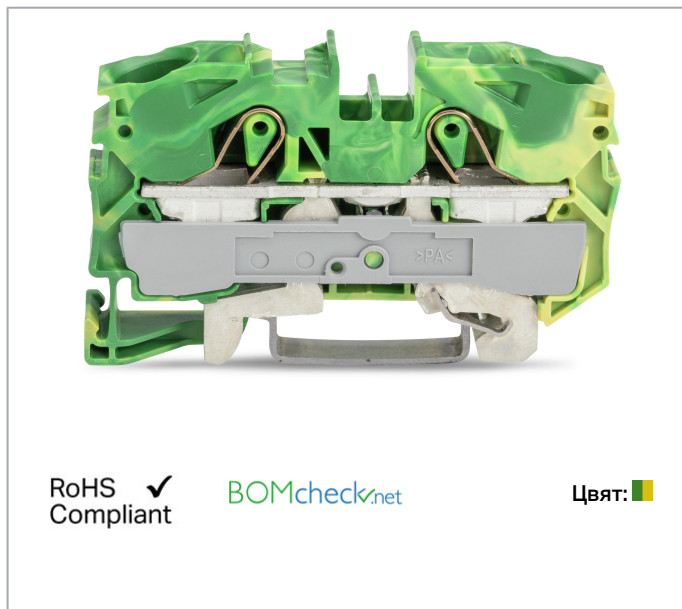

### Описание на артикула

#### Safety information 1:

15 mm high DIN-35 rails shall be used for a current load higher than 76 A!

### Данни

#### Electrical data

Подлежи на промяна. Моля, обърнете внимание и на допълнителната документация на продукта!

ВАГО България ООД  
Бизнес център Сердика  
Бул."Акад. Иван Гешов" 2Е | Сграда 1, ет. 4, офис 417 | 1330 София  
Тел.: +359 2 489 46 09 | Тел.: +359 2 489 46 10  
Имейл: [sales.bg@wago.com](mailto:sales.bg@wago.com)

Имате ли въпроси относно нашите продукти?  
Винаги ще се радваме да получим вашето обаждане на +359 2 489 46 09.

## Ratings per IEC/EN 60664-1

Ratings per

IEC/EN 60947-7-2

## Connection data

Connection technology	Push-in CAGE CLAMP®
Actuation type	Push-in Operating tool
Connectable conductor materials	Copper
Nominal cross-section	16 mm <sup>2</sup>
Solid conductor	0,5 ... 16 mm <sup>2</sup> / 20 ... 6 AWG
Solid conductor; push-in termination	6 ... 16 mm <sup>2</sup> / 14 ... 6 AWG
Fine-stranded conductor	0,5 ... 25 mm <sup>2</sup> / 20 ... 4 AWG
Fine-stranded conductor; with insulated ferrule	6 ... 16 mm <sup>2</sup> / 10 ... 6 AWG
Fine-stranded conductor; with ferrule; push-in termination	6 ... 16 mm <sup>2</sup> / 10 ... 6 AWG
Note (conductor cross-section)	Depending on the conductor characteristic, a conductor with a smaller cross-section can also be inserted via push-in termination.
Strip length	18 ... 20 mm / 0.71 ... 0.79 inch
Total number of connection points	2
Total number of potentials	1
Number of levels	1
Wiring type	Front-entry wiring
Number of jumper slots	2

## Physical data

Width	12 mm / 0.472 inch
Height from upper-edge of DIN-rail	36,9 mm / 1.453 inch
Depth	69,8 mm / 2.748 inch

## Mechanical data

Design	horizontal type
Mounting type	DIN-35 rail
Marking level	Center/side marking

## Material Data

Color	green-yellow
Insulation material	Polyamide (PA66)

Подлежи на промяна. Моля, обърнете внимание и на допълнителната документация на продукта!

ВАГО България ООД  
Бизнес център Сердика  
Бул."Акад. Иван Гешов" 2Е | Сграда 1, ет. 4, офис 417 | 1330 София  
Тел.: +359 2 489 46 09 | Тел.: +359 2 489 46 10  
Имейл: [sales.bg@wago.com](mailto:sales.bg@wago.com)

Имате ли въпроси относно нашите продукти?  
Винаги ще се радваме да получим вашето обаждане на +359 2 489 46 09.



Fire load	0,28 MJ
Weight	38,5 g

### Commercial data



Product Group	22 (TOPJOB S)
Packaging type	BOX
Country of origin	DE
GTIN	4017332076654
Customs tariff number	85369010000

### Одобрения / Сертификати

#### Ex-Approvals

Лого	Одобрение	Допълнителен текст за одобрение	Име на сертификат
	AEx UL International Germany GmbH c/o Physikalisch Technische Bundesanstalt	UL 60079	E185892 sec.9
	CCCEX CQST/CNEX	CNCA-C23-01	2020312313000162

#### Country specific Approvals

Лого	Одобрение	Допълнителен текст за одобрение	Име на сертификат
	CCA DEKRA Certification B.V.	EN 60947	NTR NL-7294
	CSA DEKRA Certification B.V.	C22.2 No. 158	1579112
	EAC Brjansker Zertifizierungsstelle	TP TC 012/2011	RU C-DE. AM02.B. 00127/19

#### Ship Approvals

Лого	Одобрение	Допълнителен текст за одобрение	Име на сертификат
------	-----------	---------------------------------	-------------------

Подлежи на промяна. Моля, обърнете внимание и на допълнителната документация на продукта!

ВАГО България ООД  
Бизнес център Сердика  
Бул."Акад. Иван Гешов" 2Е | Сграда 1, ет. 4, офис 417 | 1330 София  
Тел.: +359 2 489 46 09 | Тел.: +359 2 489 46 10  
Имейл: [sales.bg@wago.com](mailto:sales.bg@wago.com)

Имате ли въпроси относно нашите продукти?  
Винаги ще се радваме да получим вашето обаждане на +359 2 489 46 09.



	<b>ABS</b> American Bureau of Shipping	-	20- HG1941090- PDA
	<b>BV</b> Bureau Veritas S.A.	EN 60947	38586/A0
	<b>DNV GL</b> Det Norske Veritas, Germanischer Lloyd	-	TAE00001V2
	<b>LR</b> Lloyds Register	EN 60947	91/20112 (E9)

## UL-Approvals

Лого	Одобрение	Допълнителен текст за одобрение	Име на сертификат
	<b>UL</b> Underwriters Laboratories Inc.	UL 1059	20190731E45172



## Изискват се аксесоари

## End plate

	<b>Артикул №: 2016-1291</b> End and intermediate plate; 1 mm thick; gray	<a href="http://www.wago.com/2016-1291">www.wago.com/2016-1291</a>
	<b>Артикул №: 2016-1292</b> End and intermediate plate; 1 mm thick; orange	<a href="http://www.wago.com/2016-1292">www.wago.com/2016-1292</a>

## Съвместими продукти

## Carrier rail

	<b>Артикул №: 210-112</b> Steel carrier rail; 35 x 7.5 mm; 1 mm thick; 2 m long; slotted; according to EN 60715; "Hole width 25 mm; silver-colored	<a href="http://www.wago.com/210-112">www.wago.com/210-112</a>
	<b>Артикул №: 210-113</b> Steel carrier rail; 35 x 7.5 mm; 1 mm thick; 2 m long; unslotted; according to EN 60715; silver-colored	<a href="http://www.wago.com/210-113">www.wago.com/210-113</a>
	<b>Артикул №: 210-114</b> Steel carrier rail; 35 x 15 mm; 1.5 mm thick; 2 m long; unslotted; similar to EN 60715; silver-colored	<a href="http://www.wago.com/210-114">www.wago.com/210-114</a>

Подлежи на промяна. Моля, обърнете внимание и на допълнителната документация на продукта!

ВАГО България ООД  
Бизнес център Сердика  
Бул."Акад. Иван Гешов" 2Е | Сграда 1, ет. 4, офис 417 | 1330 София  
Тел.: +359 2 489 46 09 | Тел.: +359 2 489 46 10  
Имейл: [sales.bg@wago.com](mailto:sales.bg@wago.com)

Имате ли въпроси относно нашите продукти?  
Винаги ще се радваме да получим вашето обаждане на +359 2 489 46 09.

**Артикул №: 210-115**Steel carrier rail; 35 x 7.5 mm; 1 mm thick; 2 m long; slotted; according to EN 60715; "Hole width 18 mm; [www.wago.com/210-115](http://www.wago.com/210-115)  
silver-colored**Артикул №: 210-118**Steel carrier rail; 35 x 15 mm; 2.3 mm thick; 2 m long; unslotted; according to EN 60715; silver-colored [www.wago.com/210-118](http://www.wago.com/210-118)**Артикул №: 210-196**Aluminum carrier rail; 35 x 8.2 mm; 1.6 mm thick; 2 m long; unslotted; similar to EN 60715; silver-colored [www.wago.com/210-196](http://www.wago.com/210-196)**Артикул №: 210-197**Steel carrier rail; 35 x 15 mm; 1.5 mm thick; 2 m long; slotted; similar to EN 60715; silver-colored [www.wago.com/210-197](http://www.wago.com/210-197)**Артикул №: 210-198**Copper carrier rail; 35 x 15 mm; 2.3 mm thick; 2 m long; unslotted; according to EN 60715; copper-colored [www.wago.com/210-198](http://www.wago.com/210-198)**Protective Warning Marker****Артикул №: 2016-115**Protective warning marker; with high-voltage symbol, black; for 5 terminal blocks; yellow [www.wago.com/2016-115](http://www.wago.com/2016-115)**Marking accessories****Артикул №: 2009-110**Marking strips; for Smart Printer; on reel; not stretchable; plain; snap-on type; white [www.wago.com/2009-110](http://www.wago.com/2009-110)**Артикул №: 2009-115**WMB-Inline; for Smart Printer; 1500 pieces on roll; stretchable 5 - 5.2 mm; plain; snap-on type; white [www.wago.com/2009-115](http://www.wago.com/2009-115)**Артикул №: 2009-115/000-002**WMB-Inline; for Smart Printer; 1500 pieces on roll; stretchable 5 - 5.2 mm; plain; snap-on type; yellow [www.wago.com/2009-115/000-002](http://www.wago.com/2009-115/000-002)**Артикул №: 2009-115/000-006**WMB-Inline; for Smart Printer; 1500 pieces on roll; stretchable 5 - 5.2 mm; plain; snap-on type; blue [www.wago.com/2009-115/000-006](http://www.wago.com/2009-115/000-006)**Артикул №: 2009-115/000-007**WMB-Inline; for Smart Printer; 1500 pieces on roll; stretchable 5 - 5.2 mm; plain; snap-on type; gray [www.wago.com/2009-115/000-007](http://www.wago.com/2009-115/000-007)**Артикул №: 2009-115/000-012**WMB-Inline; for Smart Printer; 1500 pieces on roll; stretchable 5 - 5.2 mm; plain; snap-on type; orange [www.wago.com/2009-115/000-012](http://www.wago.com/2009-115/000-012)**Артикул №: 2009-115/000-017**WMB-Inline; for Smart Printer; 1500 pieces on roll; stretchable 5 - 5.2 mm; plain; snap-on type; light green [www.wago.com/2009-115/000-017](http://www.wago.com/2009-115/000-017)**Артикул №: 2009-115/000-023**WMB-Inline; for Smart Printer; 1500 pieces on roll; stretchable 5 - 5.2 mm; plain; snap-on type; green [www.wago.com/2009-115/000-023](http://www.wago.com/2009-115/000-023)

Подлежи на промяна. Моля, обърнете внимание и на допълнителната документация на продукта!

ВАГО България ООД

Бизнес център Сердика















Бул."Акад. Иван Гешов" 2Е | Сграда 1, ет. 4, офис 417 | 1330 София

Тел.: +359 2 489 46 09 | Тел.: +359 2 489 46 10

Имейл: [sales.bg@wago.com](mailto:sales.bg@wago.com)

Имате ли въпроси относно нашите продукти?

Винаги ще се радваме да получим вашето обаждане на +359 2 489 46 09.

	<b>Артикул №: 2009-115/000-024</b> WMB-Inline; for Smart Printer; 1500 pieces on roll; stretchable 5 - 5.2 mm; plain; snap-on type; violet	<a href="http://www.wago.com/2009-115/000-024">www.wago.com/2009-115/000-024</a>
	<b>Артикул №: 2009-145</b> Mini-WSB Inline; for Smart Printer; 1700 pieces on roll; stretchable 5 - 5.2 mm; plain; snap-on type; white	<a href="http://www.wago.com/2009-145">www.wago.com/2009-145</a>
	<b>Артикул №: 2009-145/000-002</b> Mini-WSB Inline; for Smart Printer; 1700 pieces on roll; stretchable 5 - 5.2 mm; plain; snap-on type; yellow	<a href="http://www.wago.com/2009-145/000-002">www.wago.com/2009-145/000-002</a>
	<b>Артикул №: 2009-145/000-005</b> Mini-WSB Inline; for Smart Printer; 1700 pieces on roll; stretchable 5 - 5.2 mm; plain; snap-on type; red	<a href="http://www.wago.com/2009-145/000-005">www.wago.com/2009-145/000-005</a>
	<b>Артикул №: 2009-145/000-006</b> Mini-WSB Inline; for Smart Printer; 1700 pieces on roll; stretchable 5 - 5.2 mm; plain; snap-on type; blue	<a href="http://www.wago.com/2009-145/000-006">www.wago.com/2009-145/000-006</a>
	<b>Артикул №: 2009-145/000-007</b> Mini-WSB Inline; for Smart Printer; 1700 pieces on roll; stretchable 5 - 5.2 mm; plain; snap-on type; gray	<a href="http://www.wago.com/2009-145/000-007">www.wago.com/2009-145/000-007</a>
	<b>Артикул №: 2009-145/000-012</b> Mini-WSB Inline; for Smart Printer; 1700 pieces on roll; stretchable 5 - 5.2 mm; plain; snap-on type; orange	<a href="http://www.wago.com/2009-145/000-012">www.wago.com/2009-145/000-012</a>
	<b>Артикул №: 2009-145/000-023</b> Mini-WSB Inline; for Smart Printer; 1700 pieces on roll; stretchable 5 - 5.2 mm; plain; snap-on type; green	<a href="http://www.wago.com/2009-145/000-023">www.wago.com/2009-145/000-023</a>
	<b>Артикул №: 2009-145/000-024</b> Mini-WSB Inline; for Smart Printer; 1700 pieces on roll; stretchable 5 - 5.2 mm; plain; snap-on type; violet	<a href="http://www.wago.com/2009-145/000-024">www.wago.com/2009-145/000-024</a>
	<b>Артикул №: 2009-191</b> Group marker carrier	<a href="http://www.wago.com/2009-191">www.wago.com/2009-191</a>
	<b>Артикул №: 2009-192</b> Group marker carrier	<a href="http://www.wago.com/2009-192">www.wago.com/2009-192</a>
	<b>Артикул №: 2009-193</b> Group marker carrier	<a href="http://www.wago.com/2009-193">www.wago.com/2009-193</a>
	<b>Артикул №: 2009-198</b> Adaptor; gray	<a href="http://www.wago.com/2009-198">www.wago.com/2009-198</a>
	<b>Артикул №: 248-501</b> Miniature WSB Quick marking system; plain; Marker width 5 mm; 10 strips with 10 markers per card	<a href="http://www.wago.com/248-501">www.wago.com/248-501</a>
	<b>Артикул №: 248-501/000-002</b> Mini-WSB marking card; as card; not stretchable; plain; snap-on type; yellow	<a href="http://www.wago.com/248-501/000-002">www.wago.com/248-501/000-002</a>

Подлежи на промяна. Моля, обърнете внимание и на допълнителната документация на продукта!

ВАГО България ООД  
Бизнес център Сердика  
Бул."Акад. Иван Гешов" 2Е | Сграда 1, ет. 4, офис 417 | 1330 София  
Тел.: +359 2 489 46 09 | Тел.: +359 2 489 46 10  
Имейл: [sales.bg@wago.com](mailto:sales.bg@wago.com)

Имате ли въпроси относно нашите продукти?  
Винаги ще се радваме да получим вашето обаждане на +359 2 489 46 09.



**Артикул №: 248-501/000-005**  
Mini-WSB marking card; as card; not stretchable; plain; snap-on type; red

[www.wago.com/248-501/000-005](http://www.wago.com/248-501/000-005)



**Артикул №: 248-501/000-006**  
Mini-WSB marking card; as card; not stretchable; plain; snap-on type; blue

[www.wago.com/248-501/000-006](http://www.wago.com/248-501/000-006)



**Артикул №: 248-501/000-007**  
Mini-WSB marking card; as card; not stretchable; plain; snap-on type; gray

[www.wago.com/248-501/000-007](http://www.wago.com/248-501/000-007)



**Артикул №: 248-501/000-012**  
Mini-WSB marking card; as card; not stretchable; plain; snap-on type; orange

[www.wago.com/248-501/000-012](http://www.wago.com/248-501/000-012)



**Артикул №: 248-501/000-017**  
Mini-WSB marking card; as card; not stretchable; plain; snap-on type; light green

[www.wago.com/248-501/000-017](http://www.wago.com/248-501/000-017)



**Артикул №: 248-501/000-023**  
Mini-WSB marking card; as card; not stretchable; plain; snap-on type; green

[www.wago.com/248-501/000-023](http://www.wago.com/248-501/000-023)



**Артикул №: 248-501/000-024**  
Mini-WSB marking card; as card; not stretchable; plain; snap-on type; violet

[www.wago.com/248-501/000-024](http://www.wago.com/248-501/000-024)



**Артикул №: 793-501**  
WMB marking card; as card; not stretchable; plain; snap-on type; white

[www.wago.com/793-501](http://www.wago.com/793-501)



**Артикул №: 793-501/000-002**  
WMB marking card; as card; not stretchable; plain; snap-on type; yellow

[www.wago.com/793-501/000-002](http://www.wago.com/793-501/000-002)



**Артикул №: 793-501/000-005**  
WMB marking card; as card; not stretchable; plain; snap-on type; red

[www.wago.com/793-501/000-005](http://www.wago.com/793-501/000-005)



**Артикул №: 793-501/000-006**  
WMB marking card; as card; not stretchable; plain; snap-on type; blue

[www.wago.com/793-501/000-006](http://www.wago.com/793-501/000-006)



**Артикул №: 793-501/000-007**  
WMB marking card; as card; not stretchable; plain; snap-on type; gray

[www.wago.com/793-501/000-007](http://www.wago.com/793-501/000-007)



**Артикул №: 793-501/000-012**  
WMB marking card; as card; not stretchable; plain; snap-on type; orange

[www.wago.com/793-501/000-012](http://www.wago.com/793-501/000-012)



**Артикул №: 793-501/000-017**  
WMB marking card; as card; not stretchable; plain; snap-on type; light green

[www.wago.com/793-501/000-017](http://www.wago.com/793-501/000-017)

Подлежи на промяна. Моля, обърнете внимание и на допълнителната документация на продукта!

ВАГО България ООД  
Бизнес център Сердика  
Бул."Акад. Иван Гешов" 2Е | Сграда 1, ет. 4, офис 417 | 1330 София  
Тел.: +359 2 489 46 09 | Тел.: +359 2 489 46 10  
Имейл: [sales.bg@wago.com](mailto:sales.bg@wago.com)

Имате ли въпроси относно нашите продукти?  
Винаги ще се радваме да получим вашето обаждане на +359 2 489 46 09.



**Артикул №: 793-501/000-023**  
WMB marking card; as card; not stretchable; plain; snap-on type; green

[www.wago.com/793-501/000-023](http://www.wago.com/793-501/000-023)



**Артикул №: 793-501/000-024**  
WMB marking card; as card; not stretchable; plain; snap-on type; violet

[www.wago.com/793-501/000-024](http://www.wago.com/793-501/000-024)



**Артикул №: 793-5501**  
WMB marking card; as card; for terminal block width 5 - 17.5 mm; stretchable 5 - 5.2 mm; plain; snap-on type; white

[www.wago.com/793-5501](http://www.wago.com/793-5501)



**Артикул №: 793-5501/000-002**  
WMB marking card; as card; for terminal block width 5 - 17.5 mm; stretchable 5 - 5.2 mm; plain; snap-on type; yellow

[www.wago.com/793-5501/000-002](http://www.wago.com/793-5501/000-002)



**Артикул №: 793-5501/000-005**  
WMB marking card; as card; for terminal block width 5 - 17.5 mm; stretchable 5 - 5.2 mm; plain; snap-on type; red

[www.wago.com/793-5501/000-005](http://www.wago.com/793-5501/000-005)



**Артикул №: 793-5501/000-006**  
WMB marking card; as card; for terminal block width 5 - 17.5 mm; stretchable 5 - 5.2 mm; plain; snap-on type; blue

[www.wago.com/793-5501/000-006](http://www.wago.com/793-5501/000-006)



**Артикул №: 793-5501/000-007**  
WMB marking card; as card; for terminal block width 5 - 17.5 mm; stretchable 5 - 5.2 mm; plain; snap-on type; gray

[www.wago.com/793-5501/000-007](http://www.wago.com/793-5501/000-007)



**Артикул №: 793-5501/000-012**  
WMB marking card; as card; for terminal block width 5 - 17.5 mm; stretchable 5 - 5.2 mm; plain; snap-on type; orange

[www.wago.com/793-5501/000-012](http://www.wago.com/793-5501/000-012)



**Артикул №: 793-5501/000-017**  
WMB marking card; as card; for terminal block width 5 - 17.5 mm; stretchable 5 - 5.2 mm; plain; snap-on type; green

[www.wago.com/793-5501/000-017](http://www.wago.com/793-5501/000-017)



**Артикул №: 793-5501/000-023**  
WMB marking card; as card; for terminal block width 5 - 17.5 mm; stretchable 5 - 5.2 mm; plain; snap-on type; light green

[www.wago.com/793-5501/000-023](http://www.wago.com/793-5501/000-023)



**Артикул №: 793-5501/000-024**  
WMB marking card; as card; for terminal block width 5 - 17.5 mm; stretchable 5 - 5.2 mm; plain; snap-on type; violet

[www.wago.com/793-5501/000-024](http://www.wago.com/793-5501/000-024)

#### protection



**Артикул №: 2016-100**  
Finger guard; touchproof cover protects unused conductor entries; yellow

[www.wago.com/2016-100](http://www.wago.com/2016-100)

#### check

















**Артикул №: 2009-174**  
Test plug adapter; for 4 mm Ø test plugs; for testing TOPJOB®S rail-mounted terminal blocks; gray

[www.wago.com/2009-174](http://www.wago.com/2009-174)

**Артикул №: 2009-182**

Подлежи на промяна. Моля, обърнете внимание и на допълнителната документация на продукта!

	Testing tap; for max. 2.5 mm <sup>2</sup> ; tool-free connection for individual test wires 0.08 - 2.5 mm; gray	<a href="http://www.wago.com/2009-182">www.wago.com/2009-182</a>
	<b>Артикул №: 2016-511</b> Modular TOPJOB®S connector; modular; for jumper contact slot; 1-pole; 16,00 mm <sup>2</sup> ; gray	<a href="http://www.wago.com/2016-511">www.wago.com/2016-511</a>
	<b>Артикул №: 2016-549</b> Spacer module; modular; e.g., for bridging commoned terminal blocks; gray	<a href="http://www.wago.com/2016-549">www.wago.com/2016-549</a>
<b>tools</b>		
	<b>Артикул №: 210-721</b> Operating tool; Blade: 5.5 x 0.8 mm; with a partially insulated shaft; multicoloured	<a href="http://www.wago.com/210-721">www.wago.com/210-721</a>
<b>ferrule</b>		
	<b>Артикул №: 216-210</b> Ferrule; Sleeve for 16 mm <sup>2</sup> / AWG 6; insulated; electro-tin plated; electrolytic copper; gastight crimped; acc. to DIN 46228, Part 4/09.90; blue	<a href="http://www.wago.com/216-210">www.wago.com/216-210</a>
	<b>Артикул №: 216-284</b> Ferrule; Sleeve for 1.5 mm <sup>2</sup> / AWG 16; insulated; electro-tin plated; electrolytic copper; gastight crimped; acc. to DIN 46228, Part 4/09.90; black	<a href="http://www.wago.com/216-284">www.wago.com/216-284</a>
	<b>Артикул №: 216-286</b> Ferrule; Sleeve for 2.5 mm <sup>2</sup> / AWG 14; insulated; electro-tin plated; electrolytic copper; gastight crimped; acc. to DIN 46228, Part 4/09.90; blue	<a href="http://www.wago.com/216-286">www.wago.com/216-286</a>
	<b>Артикул №: 216-287</b> Ferrule; Sleeve for 4 mm <sup>2</sup> / AWG 12; insulated; electro-tin plated; electrolytic copper; gastight crimped; acc. to DIN 46228, Part 4/09.90; gray	<a href="http://www.wago.com/216-287">www.wago.com/216-287</a>
	<b>Артикул №: 216-288</b> Ferrule; Sleeve for 6 mm <sup>2</sup> / AWG 10; insulated; electro-tin plated; electrolytic copper; gastight crimped; acc. to DIN 46228, Part 4/09.90; yellow	<a href="http://www.wago.com/216-288">www.wago.com/216-288</a>
	<b>Артикул №: 216-289</b> Ferrule; Sleeve for 10 mm <sup>2</sup> / AWG 8; insulated; electro-tin plated; electrolytic copper; gastight crimped; acc. to DIN 46228, Part 4/09.90; red	<a href="http://www.wago.com/216-289">www.wago.com/216-289</a>
<b>Jumper</b>		
	<b>Артикул №: 2016-402</b> Jumper; 2-way; insulated; light gray	<a href="http://www.wago.com/2016-402">www.wago.com/2016-402</a>
	<b>Артикул №: 2016-403</b> Jumper; 3-way; insulated; light gray	<a href="http://www.wago.com/2016-403">www.wago.com/2016-403</a>
	<b>Артикул №: 2016-404</b> Jumper; 4-way; insulated; light gray	<a href="http://www.wago.com/2016-404">www.wago.com/2016-404</a>
	<b>Артикул №: 2016-405</b> Jumper; 5-way; insulated; light gray	<a href="http://www.wago.com/2016-405">www.wago.com/2016-405</a>
	<b>Артикул №: 2016-405/011-000</b> Star point jumper; 3-way; insulated; light gray	<a href="http://www.wago.com/2016-405/011-000">www.wago.com/2016-405/011-000</a>
	<b>Артикул №: 2016-433</b> Jumper; from 1 to 3; insulated; light gray	<a href="http://www.wago.com/2016-433">www.wago.com/2016-433</a>

Подлежи на промяна. Моля, обърнете внимание и на допълнителната документация на продукта!

ВАГО България ООД  
 Бизнес център Сердика  
 Бул."Акад. Иван Гешов" 2Е | Сграда 1, ет. 4, офис 417 | 1330 София  
 Тел.: +359 2 489 46 09 | Тел.: +359 2 489 46 10  
 Имейл: [sales.bg@wago.com](mailto:sales.bg@wago.com)

Имате ли въпроси относно нашите продукти?  
 Винаги ще се радваме да получим вашето обаждане на +359 2 489 46 09.



Артикул №: 2016-434  
Jumper; from 1 to 4; insulated; light gray

[www.wago.com/2016-434](http://www.wago.com/2016-434)



Артикул №: 2016-435  
Jumper; from 1 to 5; insulated; light gray

[www.wago.com/2016-435](http://www.wago.com/2016-435)

#### End plate



Артикул №: 209-191  
Separator for Ex e/Ex i applications; 3 mm thick; 120 mm wide; orange

[www.wago.com/209-191](http://www.wago.com/209-191)

## Изтегляния

### Documentation

#### Bid Text

2016-1207 docx - Datei	Apr 15, 2019	docx 15,3 kB	Изтегляне
---------------------------	--------------	-----------------	-----------

2016-1207 X81 - Datei	Apr 17, 2019	xml 4,1 kB	Изтегляне
--------------------------	--------------	---------------	-----------

#### Additional Information

Technical explanations	Apr 3, 2019	pdf 2,2 MB	Изтегляне
------------------------	-------------	---------------	-----------

## CAD/CAE-Data

### CAD data

2D/3D Models 2016-1207	URL	Изтегляне
------------------------	-----	-----------

### CAE data

EPLAN Data Portal 2016-1207	URL	Изтегляне
-----------------------------	-----	-----------

WSCAD Universe 2016-1207	URL	Изтегляне
--------------------------	-----	-----------

ZUKEN Portal 2016-1207	URL	Изтегляне
------------------------	-----	-----------

## Бележки за инсталиране

### Conductor termination

Подлежи на промяна. Моля, обърнете внимание и на допълнителната документация на продукта!

ВАГО България ООД  
Бизнес център Сердика  
Бул."Акад. Иван Гешов" 2Е | Сграда 1, ет. 4, офис 417 | 1330 София  
Тел.: +359 2 489 46 09 | Тел.: +359 2 489 46 10  
Имейл: [sales.bg@wago.com](mailto:sales.bg@wago.com)

Имате ли въпроси относно нашите продукти?  
Винаги ще се радваме да получим вашето обаждане на +359 2 489 46 09.

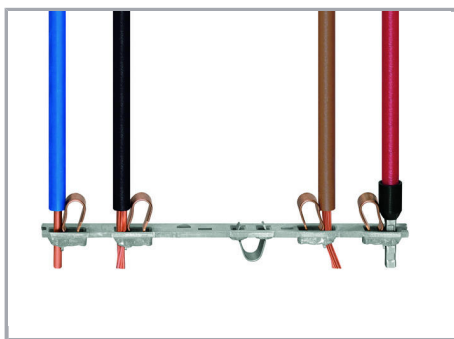

All conductor types at a glance

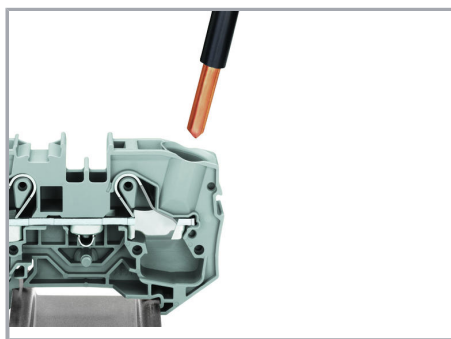

Inserting conductors via push-in termination.

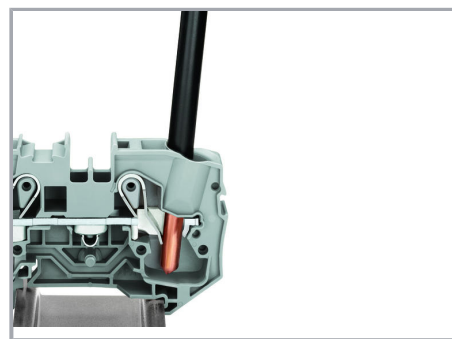

Solid conductors with cross-sections from either one size above, or up to two sizes below, the rated cross-section can be simply pushed in – no tools needed.

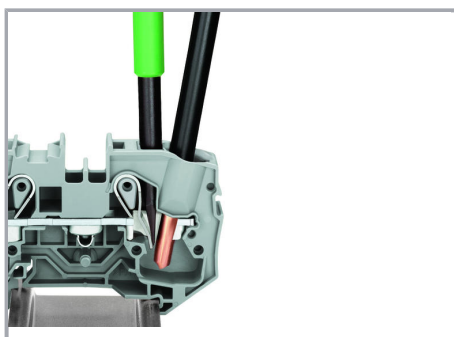

Removing a conductor.

Conductor removal is performed with an operating tool, just like CAGE CLAMP®.

### Commoning

Подлежи на промяна. Моля, обърнете внимание и на допълнителната документация на продукта!

ВАГО България ООД  
Бизнес център Сердика  
Бул."Акад. Иван Гешов" 2Е | Сграда 1, ет. 4, офис 417 | 1330 София  
Тел.: +359 2 489 46 09 | Тел.: +359 2 489 46 10  
Имейл: [sales.bg@wago.com](mailto:sales.bg@wago.com)

Имате ли въпроси относно нашите продукти?  
Винаги ще се радваме да получим вашето обаждане на +359 2 489 46 09.

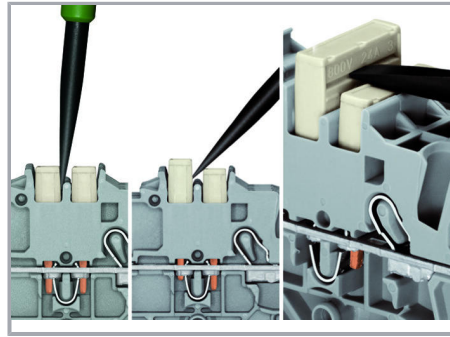
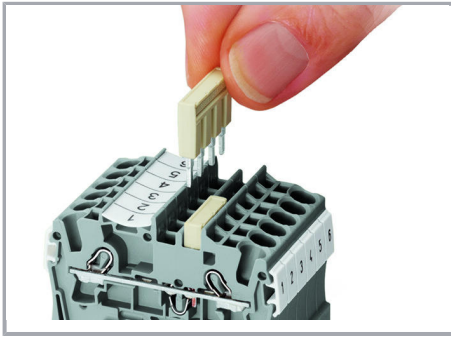

The push-in type jumper bar system is based on the common plug and socket principle. Each terminal block is spring-loaded with a double socket and a resilient CrNi steel spring. The jumper contact material is pure electrolytic copper, which allows for an extremely small design capable of carrying the full-rated current of the terminal block. Ground terminal blocks can also be commoned using the same jumper system. Custom jumpers are created by breaking and removing jumper contacts (2000, 2001, 2002, 2004 Series).

#### Removing a push-in type jumper bar.

Insert the operating tool between the jumper and the partition wall of the dual jumper slots, then lift up the jumper.

Place the operating tool in the center of jumpers up to five contacts (see above), or alternately on both sides for jumpers with more than five contacts.

#### Commoning

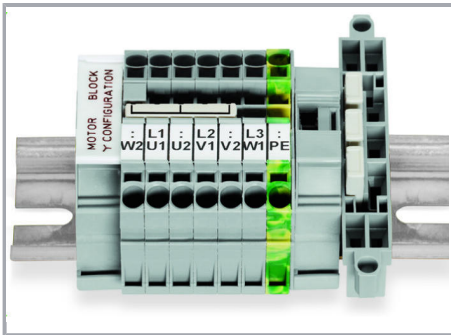

This star point jumper has been specially developed to create a "star point" and is used on motor terminal boards equipped with TOPJOB® S rail-mount terminal blocks.

#### Testing

Подлежи на промяна. Моля, обърнете внимание и на допълнителната документация на продукта!

ВАГО България ООД  
Бизнес център Сердика  
Бул."Акад. Иван Гешов" 2Е | Сграда 1, ет. 4, офис 417 | 1330 София  
Тел.: +359 2 489 46 09 | Тел.: +359 2 489 46 10  
Имейл: [sales.bg@wago.com](mailto:sales.bg@wago.com)

Имате ли въпроси относно нашите продукти?  
Винаги ще се радваме да получим вашето обаждане на +359 2 489 46 09.

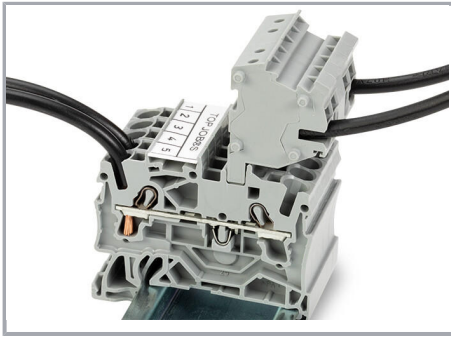

The modular TOPJOB® S connectors also connect conductors of the same size as the terminal blocks being used.

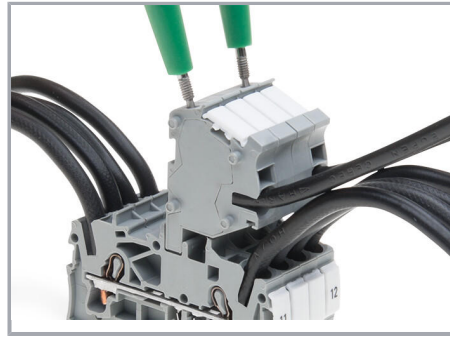

TOPJOB® S Connectors with a 2 mm Ø test socket for testing voltage via 2-pole voltage tester

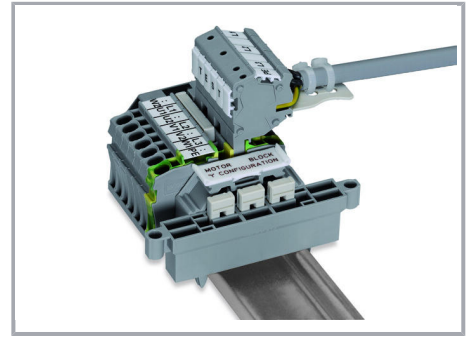

Rail-mount terminal block assembly for electric motor wiring

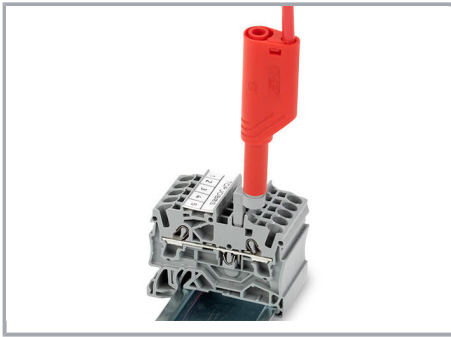

Test plug adapter (2009-174, CAT I) for 4 mm Ø plugs – compatible with 2000 to 2016 Series

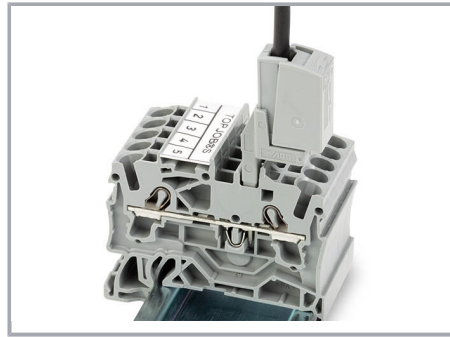

Testing tap (2009-182) for tool-free connection of test cables up to 2.5 mm<sup>2</sup> (12 AWG) – compatible with 2000 to 2016 Series

## Marking

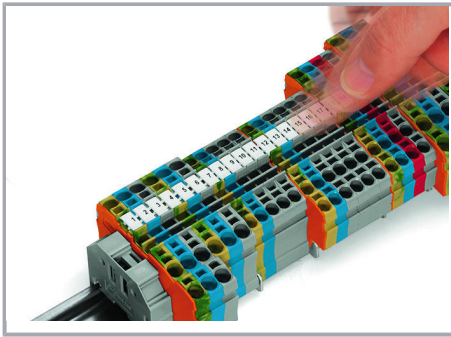

Snapping WMB Inline markers into marker slots.

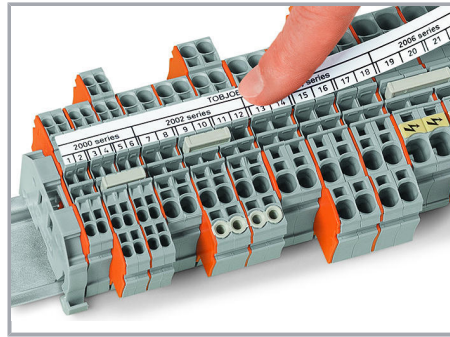

Подлежи на промяна. Моля, обърнете внимание и на допълнителната документация на продукта!

ВАГО България ООД  
Бизнес център Сердика  
Бул."Акад. Иван Гешов" 2Е | Сграда 1, ет. 4, офис 417 | 1330 София  
Тел.: +359 2 489 46 09 | Тел.: +359 2 489 46 10  
Имейл: [sales.bg@wago.com](mailto:sales.bg@wago.com)

Имате ли въпроси относно нашите продукти?  
Винаги ще се радваме да получим вашето обаждане на +359 2 489 46 09.

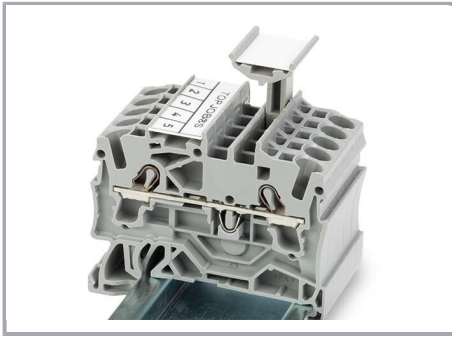

TOPJOB® S 2009-193 Group Marker Carrier (equipped with a marking strip) for all 2001 to 2016 Series TOPJOB® S Rail-Mount Terminal Blocks

Do not use on an end plate!

### Семейство продукти

#### TOPJOB® S

TOPJOB® S: In various industrial applications and modern building installations, WAGO's wide and versatile range of rail-mount terminal blocks provides more than just reliable electrical connections.

Показване на всички продукти от семейството.

Подлежи на промяна. Моля, обърнете внимание и на допълнителната документация на продукта!

ВАГО България ООД  
Бизнес център Сердика  
Бул."Акад. Иван Гешов" 2Е | Сграда 1, ет. 4, офис 417 | 1330 София  
Тел.: +359 2 489 46 09 | Тел.: +359 2 489 46 10  
Имейл: [sales.bg@wago.com](mailto:sales.bg@wago.com)

Имате ли въпроси относно нашите продукти?  
Винаги ще се радваме да получим вашето обаждане на +359 2 489 46 09.