

Информационен лист | Номер на артикул: 2006-1204

2-conductor through terminal block; 6 mm²; for Ex e II and Ex i applications;
side and center marking; for DIN-rail 35 x 15 and 35 x 7.5; Push-in CAGE
CLAMP®; 6,00 mm²; blue

www.wago.com/2006-1204

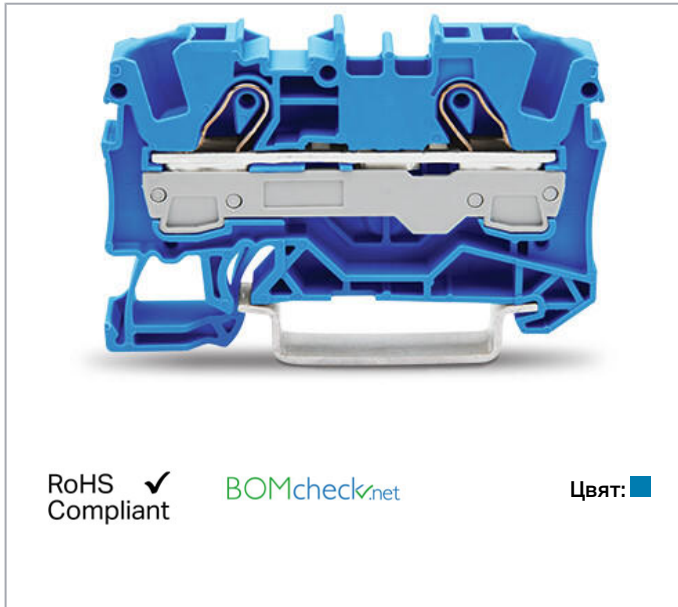

RoHS
Compliant ✓

BOMcheck.net

Цвят: ■

Данни

Electrical data

Ratings per IEC/EN 60664-1

Ratings per	IEC/EN 60947-7-1
Nominal voltage (III/3)	800 V
Rated surge voltage (III/3)	8 kV
Rated current	41 A
Rated current 2	57 A
Legend (ratings)	(III / 3) ≙ Overvoltage category III / Pollution degree 3

Ratings per UL 1059

Approvals per	UL 1059
Rated voltage UL (Use Group B)	600 V
Rated current UL (Use Group B)	50 A
Rated voltage UL (Use Group C)	600 V
Rated current UL (Use Group C)	50 A

Подлежи на промяна. Моля, обърнете внимание и на допълнителната документация на продукта!

ВАГО България ООД
Бизнес център Сердика
Бул."Акад. Иван Гешов" 2Е | Сграда 1, ет. 4, офис 417 | 1330 София
Тел.: +359 2 489 46 09 | Тел.: +359 2 489 46 10
Имейл: sales.bg@wago.com

Имате ли въпроси относно нашите продукти?
Винаги ще се радваме да получим вашето обаждане на +359 2 489 46 09.



Ratings per CSA

Rated voltage CSA (Use Group B)	600 V
Rated current CSA (Use Group B)	50 A
Rated voltage CSA (Use Group C)	600 V
Rated current CSA (Use Group C)	50 A

Ex information

Rated voltage EN (Ex e II)	550 V
Rated current (Ex e II)	38 A
Rated current (Ex e II) with jumper	33 A

Connection data

Connection technology	Push-in CAGE CLAMP®
Actuation type	Push-in Operating tool
Connectable conductor materials	Copper
Nominal cross-section	6 mm ²
Solid conductor	0,5 ... 10 mm ² / 20 ... 8 AWG
Solid conductor; push-in termination	2,5 ... 10 mm ² / 14 ... 8 AWG
Fine-stranded conductor	0,5 ... 10 mm ² / 20 ... 8 AWG
Fine-stranded conductor; with insulated ferrule	2,5 ... 6 mm ² / 16 ... 10 AWG
Fine-stranded conductor; with ferrule; push-in termination	2,5 ... 6 mm ² / 16 ... 10 AWG
Note (conductor cross-section)	Depending on the conductor characteristic, a conductor with a smaller cross-section can also be inserted via push-in termination.
Strip length	13 ... 15 mm / 0.51 ... 0.59 inch
Total number of connection points	2
Total number of potentials	1
Number of levels	1
Wiring type	Front-entry wiring
Number of jumper slots	2

Physical data

Width	7,5 mm / 0.295 inch
Height from upper-edge of DIN-rail	32,9 mm / 1.295 inch
Depth	57,5 mm / 2.264 inch

Подлежи на промяна. Моля, обърнете внимание и на допълнителната документация на продукта!

ВАГО България ООД
 Бизнес център Сердика
 Бул."Акад. Иван Гешов" 2Е | Сграда 1, ет. 4, офис 417 | 1330 София
 Тел.: +359 2 489 46 09 | Тел.: +359 2 489 46 10
 Имейл: sales.bg@wago.com

Имате ли въпроси относно нашите продукти?
 Винаги ще се радваме да получим вашето обаждане на +359 2 489 46 09.

Mechanical data

Design	horizontal type
Mounting type	DIN-35 rail
Marking level	Center/side marking

Material Data

Color	blue
Insulation material	Polyamide (PA66)
Fire load	0,154 MJ
Weight	9 g

Commercial data

Product Group	22 (TOPJOB S)
Packaging type	BOX
Country of origin	DE
GTIN	4017332999656
Customs tariff number	85369010000

Одобрения / Сертификати

Ex-Approvals

Лого	Одобрение	Допълнителен текст за одобрение	Име на сертификат
	ATEX Physikalisch Technische Bundesanstalt (PTB)	EN 60079	PTB 05 ATEX 1030 U (II 2 G Ex ell bzw. IM 2 Exe I)
	CCCEX CQST/CNEX	CNCA-C23-01	2020312313000231
	IECEX Physikalisch Technische Bundesanstalt (PTB)	IEC 60079	IECEX PTB 03.0014 U (Ex eII C Gb and Ex el Mb)

Country specific Approvals



Лого	Одобрение	Допълнителен текст за одобрение	Име на сертификат
	CCA DEKRA Certification B.V.	IEC 60947	NTR NL 7653/A1

Подлежи на промяна. Моля, обърнете внимание и на допълнителната документация на продукта!

ВАГО България ООД
Бизнес център Сердика
Бул."Акад. Иван Гешов" 2Е | Сграда 1, ет. 4, офис 417 | 1330 София
Тел.: +359 2 489 46 09 | Тел.: +359 2 489 46 10
Имейл: sales.bg@wago.com

Имате ли въпроси относно нашите продукти?
Винаги ще се радваме да получим вашето обаждане на +359 2 489 46 09.

CCA

	CSA DEKRA Certification B.V.	C22.2 No. 158	1543858
	EAC Brjansker Zertifizierungsstelle	TP TC 012/2011	RU C-DE. AM02.B. 00127/19

Ship Approvals

Лого	Одобрение	Допълнителен текст за одобрение	Име на сертификат
	ABS American Bureau of Shipping	EN 60947	20- HG1941090- PDA
	BV Bureau Veritas S.A.	EN 60947	38586/A0 BV
	DNV GL Det Norske Veritas, Germanischer Lloyd	-	TAE00001V2
	LR Lloyds Register	EN 60947	91/20112 (E9)

UL-Approvals

Лого	Одобрение	Допълнителен текст за одобрение	Име на сертификат
	UL UL International Germany GmbH	UL 1059	E45172



Изискват се аксесоари

End plate

Подлежи на промяна. Моля, обърнете внимание и на допълнителната документация на продукта!





ВАГО България ООД
Бизнес център Сердика
Бул."Акад. Иван Гешов" 2Е | Сграда 1, ет. 4, офис 417 | 1330 София
Тел.: +359 2 489 46 09 | Тел.: +359 2 489 46 10
Имейл: sales.bg@wago.com

Имате ли въпроси относно нашите продукти?
Винаги ще се радваме да получим вашето обаждане на +359 2 489 46 09.









	Артикул №: 2006-1291 End and intermediate plate; 1 mm thick; gray	www.wago.com/2006-1291
	Артикул №: 2006-1292 End and intermediate plate; 1 mm thick; orange	www.wago.com/2006-1292

Съвместими продукти

check

	Артикул №: 2006-511 Modular TOPJOB®S connector; modular; for jumper contact slot; 1-pole; 6,00 mm ² ; gray	www.wago.com/2006-511
	Артикул №: 2006-549 Spacer module; modular; e.g., for bridging commoned terminal blocks; gray	www.wago.com/2006-549
	Артикул №: 2009-174 Test plug adapter; for 4 mm Ø test plugs; for testing TOPJOB®S rail-mounted terminal blocks; gray	www.wago.com/2009-174
	Артикул №: 2009-182 Testing tap; for max. 2.5 mm ² ; tool-free connection for individual test wires 0.08 - 2.5 mm; gray	www.wago.com/2009-182
	Артикул №: 210-136 Test plug; 2 mm Ø; with 500 mm cable; red	www.wago.com/210-136

Jumper

	Артикул №: 2006-402 Jumper; 2-way; insulated; light gray	www.wago.com/2006-402
	Артикул №: 2006-403 Jumper; 3-way; insulated; light gray	www.wago.com/2006-403
	Артикул №: 2006-404 Jumper; 4-way; insulated; light gray	www.wago.com/2006-404
	Артикул №: 2006-405 Jumper; 5-way; insulated; light gray	www.wago.com/2006-405
	Артикул №: 2006-405/011-000 Star point jumper; 3-way; insulated; light gray	www.wago.com/2006-405/011-000
	Артикул №: 2006-433 Jumper; from 1 to 3; insulated; light gray	www.wago.com/2006-433
	Артикул №: 2006-434 Jumper; from 1 to 4; insulated; light gray	www.wago.com/2006-434
	Артикул №: 2006-435 Jumper; from 1 to 5; insulated; light gray	www.wago.com/2006-435
	Артикул №: 2006-499 Step-down jumper; insulated; light gray	www.wago.com/2006-499

Подлежи на промяна. Моля, обърнете внимание и на допълнителната документация на продукта!

ВАГО България ООД
Бизнес център Сердика
Бул."Акад. Иван Гешов" 2Е | Сграда 1, ет. 4, офис 417 | 1330 София
Тел.: +359 2 489 46 09 | Тел.: +359 2 489 46 10
Имейл: sales.bg@wago.com

Имате ли въпроси относно нашите продукти?
Винаги ще се радваме да получим вашето обаждане на +359 2 489 46 09.



Артикул №: 2016-499
Step-down jumper; insulated; light gray

www.wago.com/2016-499

protection



Артикул №: 2006-191
Lockout cap; for wire insertion and actuating opening; gray

www.wago.com/2006-191

ferrule



Артикул №: 216-208
Ferrule; Sleeve for 6 mm² / AWG 10; insulated; electro-tin plated; electrolytic copper; gastight crimped; acc. to DIN 46228, Part 4/09.90; yellow www.wago.com/216-208



Артикул №: 216-262
Ferrule; Sleeve for 0.75 mm² / 18 AWG; insulated; electro-tin plated; electrolytic copper; gastight crimped; acc. to DIN 46228, Part 4/09.90; gray www.wago.com/216-262



Артикул №: 216-263
Ferrule; Sleeve for 1 mm² / AWG 18; insulated; electro-tin plated; electrolytic copper; gastight crimped; acc. to DIN 46228, Part 4/09.90; red www.wago.com/216-263



Артикул №: 216-264
Ferrule; Sleeve for 1.5 mm² / AWG 16; insulated; electro-tin plated; electrolytic copper; gastight crimped; acc. to DIN 46228, Part 4/09.90; black www.wago.com/216-264



Артикул №: 216-266
Ferrule; Sleeve for 2.5 mm² / AWG 14; insulated; electro-tin plated; electrolytic copper; gastight crimped; acc. to DIN 46228, Part 4/09.90; blue www.wago.com/216-266



Артикул №: 216-267
Ferrule; Sleeve for 4 mm² / AWG 12; insulated; electro-tin plated; electrolytic copper; gastight crimped; acc. to DIN 46228, Part 4/09.90; gray www.wago.com/216-267

End plate



Артикул №: 2006-1293
Separator plate; 2 mm thick; oversized; gray

www.wago.com/2006-1293



Артикул №: 2006-1294
Separator plate; 2 mm thick; oversized; orange

www.wago.com/2006-1294



Артикул №: 209-191
Separator for Ex e/Ex i applications; 3 mm thick; 120 mm wide; orange

www.wago.com/209-191

Protective Warning Marker



Артикул №: 2006-115
Protective warning marker; with high-voltage symbol, black; for 5 terminal blocks; yellow

www.wago.com/2006-115

Carrier rail



Артикул №: 210-112
Steel carrier rail; 35 x 7.5 mm; 1 mm thick; 2 m long; slotted; according to EN 60715; "Hole width 25 mm; silver-colored www.wago.com/210-112

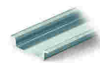

Артикул №: 210-113
Steel carrier rail; 35 x 7.5 mm; 1 mm thick; 2 m long; unslotted; according to EN 60715; silver-colored www.wago.com/210-113

















Артикул №: 210-114
Steel carrier rail; 35 x 15 mm; 1.5 mm thick; 2 m long; unslotted; similar to EN 60715; silver-colored www.wago.com/210-114

Подлежи на промяна. Моля, обърнете внимание и на допълнителната документация на продукта!

ВАГО България ООД
Бизнес център Сердика
Бул."Акад. Иван Гешов" 2Е | Сграда 1, ет. 4, офис 417 | 1330 София
Тел.: +359 2 489 46 09 | Тел.: +359 2 489 46 10
Имейл: sales.bg@wago.com

Имате ли въпроси относно нашите продукти?
Винаги ще се радваме да получим вашето обаждане на +359 2 489 46 09.

	Артикул №: 210-115 Steel carrier rail; 35 x 7.5 mm; 1 mm thick; 2 m long; slotted; according to EN 60715; "Hole width 18 mm; silver-colored	www.wago.com/210-115
	Артикул №: 210-118 Steel carrier rail; 35 x 15 mm; 2.3 mm thick; 2 m long; unslotted; according to EN 60715; silver-colored	www.wago.com/210-118
	Артикул №: 210-196 Aluminum carrier rail; 35 x 8.2 mm; 1.6 mm thick; 2 m long; unslotted; similar to EN 60715; silver-colored	www.wago.com/210-196
	Артикул №: 210-197 Steel carrier rail; 35 x 15 mm; 1.5 mm thick; 2 m long; slotted; similar to EN 60715; silver-colored	www.wago.com/210-197
	Артикул №: 210-198 Copper carrier rail; 35 x 15 mm; 2.3 mm thick; 2 m long; unslotted; according to EN 60715; copper-colored	www.wago.com/210-198
	Артикул №: 210-504 Steel carrier rail; 35 x 7.5 mm; 1 mm thick; 2 m long; slotted; galvanized; according to EN 60715	www.wago.com/210-504
	Артикул №: 210-505 Steel carrier rail; 35 x 7.5 mm; 1 mm thick; 2 m long; unslotted; galvanized; according to EN 60715; silver-colored	www.wago.com/210-505
	Артикул №: 210-506 Steel carrier rail; 35 x 15 mm; 1.5 mm thick; 2 m long; unslotted; galvanized; similar to EN 60715; silver-colored	www.wago.com/210-506
	Артикул №: 210-508 Steel carrier rail; 35 x 15 mm; 1.5 mm thick; 2 m long; slotted; galvanized; similar to EN 60715; silver-colored	www.wago.com/210-508
tools		
	Артикул №: 210-721 Operating tool; Blade: 5.5 x 0.8 mm; with a partially insulated shaft; multicoloured	www.wago.com/210-721
Marking accessories		
	Артикул №: 2009-110 Marking strips; for Smart Printer; on reel; not stretchable; plain; snap-on type; white	www.wago.com/2009-110
	Артикул №: 2009-115 WMB-Inline; for Smart Printer; 1500 pieces on roll; stretchable 5 - 5.2 mm; plain; snap-on type; white	www.wago.com/2009-115
	Артикул №: 2009-115/000-002 WMB-Inline; for Smart Printer; 1500 pieces on roll; stretchable 5 - 5.2 mm; plain; snap-on type; yellow	www.wago.com/2009-115/000-002
	Артикул №: 2009-115/000-006 WMB-Inline; for Smart Printer; 1500 pieces on roll; stretchable 5 - 5.2 mm; plain; snap-on type; blue	www.wago.com/2009-115/000-006
	Артикул №: 2009-115/000-007 WMB-Inline; for Smart Printer; 1500 pieces on roll; stretchable 5 - 5.2 mm; plain; snap-on type; gray	www.wago.com/2009-115/000-007

Подлежи на промяна. Моля, обърнете внимание и на допълнителната документация на продукта!

ВАГО България ООД
Бизнес център Сердика
Бул."Акад. Иван Гешов" 2Е | Сграда 1, ет. 4, офис 417 | 1330 София
Тел.: +359 2 489 46 09 | Тел.: +359 2 489 46 10
Имейл: sales.bg@wago.com















Имате ли въпроси относно нашите продукти?
Винаги ще се радваме да получим вашето обаждане на +359 2 489 46 09.

	Артикул №: 2009-115/000-012 WMB-Inline; for Smart Printer; 1500 pieces on roll; stretchable 5 - 5.2 mm; plain; snap-on type; orange	www.wago.com/2009-115/000-012
	Артикул №: 2009-115/000-017 WMB-Inline; for Smart Printer; 1500 pieces on roll; stretchable 5 - 5.2 mm; plain; snap-on type; light green	www.wago.com/2009-115/000-017
	Артикул №: 2009-115/000-023 WMB-Inline; for Smart Printer; 1500 pieces on roll; stretchable 5 - 5.2 mm; plain; snap-on type; green	www.wago.com/2009-115/000-023
	Артикул №: 2009-115/000-024 WMB-Inline; for Smart Printer; 1500 pieces on roll; stretchable 5 - 5.2 mm; plain; snap-on type; violet	www.wago.com/2009-115/000-024
	Артикул №: 2009-145 Mini-WSB Inline; for Smart Printer; 1700 pieces on roll; stretchable 5 - 5.2 mm; plain; snap-on type; white	www.wago.com/2009-145
	Артикул №: 2009-145/000-002 Mini-WSB Inline; for Smart Printer; 1700 pieces on roll; stretchable 5 - 5.2 mm; plain; snap-on type; yellow	www.wago.com/2009-145/000-002
	Артикул №: 2009-145/000-005 Mini-WSB Inline; for Smart Printer; 1700 pieces on roll; stretchable 5 - 5.2 mm; plain; snap-on type; red	www.wago.com/2009-145/000-005
	Артикул №: 2009-145/000-006 Mini-WSB Inline; for Smart Printer; 1700 pieces on roll; stretchable 5 - 5.2 mm; plain; snap-on type; blue	www.wago.com/2009-145/000-006
	Артикул №: 2009-145/000-007 Mini-WSB Inline; for Smart Printer; 1700 pieces on roll; stretchable 5 - 5.2 mm; plain; snap-on type; gray	www.wago.com/2009-145/000-007
	Артикул №: 2009-145/000-012 Mini-WSB Inline; for Smart Printer; 1700 pieces on roll; stretchable 5 - 5.2 mm; plain; snap-on type; orange	www.wago.com/2009-145/000-012
	Артикул №: 2009-145/000-023 Mini-WSB Inline; for Smart Printer; 1700 pieces on roll; stretchable 5 - 5.2 mm; plain; snap-on type; green	www.wago.com/2009-145/000-023
	Артикул №: 2009-145/000-024 Mini-WSB Inline; for Smart Printer; 1700 pieces on roll; stretchable 5 - 5.2 mm; plain; snap-on type; violet	www.wago.com/2009-145/000-024
	Артикул №: 2009-191 Group marker carrier	www.wago.com/2009-191
	Артикул №: 2009-192 Group marker carrier	www.wago.com/2009-192

Подлежи на промяна. Моля, обърнете внимание и на допълнителната документация на продукта!

ВАГО България ООД
 Бизнес център Сердика
 Бул."Акад. Иван Гешов" 2Е | Сграда 1, ет. 4, офис 417 | 1330 София
 Тел.: +359 2 489 46 09 | Тел.: +359 2 489 46 10
 Имейл: sales.bg@wago.com

Имате ли въпроси относно нашите продукти?
 Винаги ще се радваме да получим вашето обаждане на +359 2 489 46 09.

	Артикул №: 2009-193 Group marker carrier	www.wago.com/2009-193
	Артикул №: 2009-198 Adaptor; gray	www.wago.com/2009-198
	Артикул №: 248-501 Miniature WSB Quick marking system; plain; Marker width 5 mm; 10 strips with 10 markers per card	www.wago.com/248-501
	Артикул №: 248-501/000-002 Mini-WSB marking card; as card; not stretchable; plain; snap-on type; yellow	www.wago.com/248-501/000-002
	Артикул №: 248-501/000-005 Mini-WSB marking card; as card; not stretchable; plain; snap-on type; red	www.wago.com/248-501/000-005
	Артикул №: 248-501/000-006 Mini-WSB marking card; as card; not stretchable; plain; snap-on type; blue	www.wago.com/248-501/000-006
	Артикул №: 248-501/000-007 Mini-WSB marking card; as card; not stretchable; plain; snap-on type; gray	www.wago.com/248-501/000-007
	Артикул №: 248-501/000-012 Mini-WSB marking card; as card; not stretchable; plain; snap-on type; orange	www.wago.com/248-501/000-012
	Артикул №: 248-501/000-017 Mini-WSB marking card; as card; not stretchable; plain; snap-on type; light green	www.wago.com/248-501/000-017
	Артикул №: 248-501/000-023 Mini-WSB marking card; as card; not stretchable; plain; snap-on type; green	www.wago.com/248-501/000-023
	Артикул №: 248-501/000-024 Mini-WSB marking card; as card; not stretchable; plain; snap-on type; violet	www.wago.com/248-501/000-024
	Артикул №: 793-501 WMB marking card; as card; not stretchable; plain; snap-on type; white	www.wago.com/793-501
	Артикул №: 793-501/000-002 WMB marking card; as card; not stretchable; plain; snap-on type; yellow	www.wago.com/793-501/000-002
	Артикул №: 793-501/000-005 WMB marking card; as card; not stretchable; plain; snap-on type; red	www.wago.com/793-501/000-005

Подлежи на промяна. Моля, обърнете внимание и на допълнителната документация на продукта!

ВАГО България ООД
Бизнес център Сердика
Бул."Акад. Иван Гешов" 2Е | Сграда 1, ет. 4, офис 417 | 1330 София
Тел.: +359 2 489 46 09 | Тел.: +359 2 489 46 10
Имейл: sales.bg@wago.com

Имате ли въпроси относно нашите продукти?
Винаги ще се радваме да получим вашето обаждане на +359 2 489 46 09.



Артикул №: 793-501/000-006
WMB marking card; as card; not stretchable; plain; snap-on type; blue

www.wago.com/793-501/000-006



Артикул №: 793-501/000-007
WMB marking card; as card; not stretchable; plain; snap-on type; gray

www.wago.com/793-501/000-007



Артикул №: 793-501/000-012
WMB marking card; as card; not stretchable; plain; snap-on type; orange

www.wago.com/793-501/000-012



Артикул №: 793-501/000-017
WMB marking card; as card; not stretchable; plain; snap-on type; light green

www.wago.com/793-501/000-017



Артикул №: 793-501/000-023
WMB marking card; as card; not stretchable; plain; snap-on type; green

www.wago.com/793-501/000-023



Артикул №: 793-501/000-024
WMB marking card; as card; not stretchable; plain; snap-on type; violet

www.wago.com/793-501/000-024



Артикул №: 793-5501
WMB marking card; as card; for terminal block width 5 - 17.5 mm; stretchable 5 - 5.2 mm; plain; snap-on type; white

www.wago.com/793-5501



Артикул №: 793-5501/000-002
WMB marking card; as card; for terminal block width 5 - 17.5 mm; stretchable 5 - 5.2 mm; plain; snap-on type; yellow

www.wago.com/793-5501/000-002



Артикул №: 793-5501/000-005
WMB marking card; as card; for terminal block width 5 - 17.5 mm; stretchable 5 - 5.2 mm; plain; snap-on type; red

www.wago.com/793-5501/000-005



Артикул №: 793-5501/000-006
WMB marking card; as card; for terminal block width 5 - 17.5 mm; stretchable 5 - 5.2 mm; plain; snap-on type; blue

www.wago.com/793-5501/000-006



Артикул №: 793-5501/000-007
WMB marking card; as card; for terminal block width 5 - 17.5 mm; stretchable 5 - 5.2 mm; plain; snap-on type; gray

www.wago.com/793-5501/000-007



Артикул №: 793-5501/000-012
WMB marking card; as card; for terminal block width 5 - 17.5 mm; stretchable 5 - 5.2 mm; plain; snap-on type; orange

www.wago.com/793-5501/000-012



Артикул №: 793-5501/000-017
WMB marking card; as card; for terminal block width 5 - 17.5 mm; stretchable 5 - 5.2 mm; plain; snap-on type; green

www.wago.com/793-5501/000-017

Артикул №: 793-5501/000-023

Подлежи на промяна. Моля, обърнете внимание и на допълнителната документация на продукта!

ВАГО България ООД
Бизнес център Сердика
Бул."Акад. Иван Гешов" 2Е | Сграда 1, ет. 4, офис 417 | 1330 София
Тел.: +359 2 489 46 09 | Тел.: +359 2 489 46 10
Имейл: sales.bg@wago.com

Имате ли въпроси относно нашите продукти?
Винаги ще се радваме да получим вашето обаждане на +359 2 489 46 09.



WMB marking card; as card; for terminal block width 5 - 17.5 mm; stretchable 5 - 5.2 mm; plain; snap-on type; light green

www.wago.com/793-5501/000-023

**Артикул №: 793-5501/000-024**

WMB marking card; as card; for terminal block width 5 - 17.5 mm; stretchable 5 - 5.2 mm; plain; snap-on type; violet

www.wago.com/793-5501/000-024

Изтегляния**Documentation****Bid Text**

2006-1204 X81 - Datei	Apr 17, 2019	xml 4,3 kB	Изтегляне
--------------------------	--------------	---------------	-----------

2006-1204 docx - Datei	Apr 17, 2019	docx 15,3 kB	Изтегляне
---------------------------	--------------	-----------------	-----------

Additional Information

Technical explanations	Apr 3, 2019	pdf 2,2 MB	Изтегляне
------------------------	-------------	---------------	-----------

CAD/CAE-Data**CAD data**

2D/3D Models 2006-1204		URL	Изтегляне
------------------------	--	-----	-----------

CAE data

EPLAN Data Portal 2006-1204		URL	Изтегляне
-----------------------------	--	-----	-----------

WSCAD Universe 2006-1204		URL	Изтегляне
--------------------------	--	-----	-----------

ZUKEN Portal 2006-1204		URL	Изтегляне
------------------------	--	-----	-----------

Бележки за инсталиране**Conductor termination**

Подлежи на промяна. Моля, обърнете внимание и на допълнителната документация на продукта!

ВАГО България ООД
Бизнес център Сердика
Бул."Акад. Иван Гешов" 2Е | Сграда 1, ет. 4, офис 417 | 1330 София
Тел.: +359 2 489 46 09 | Тел.: +359 2 489 46 10
Имейл: sales.bg@wago.com

Имате ли въпроси относно нашите продукти?
Винаги ще се радваме да получим вашето обаждане на +359 2 489 46 09.

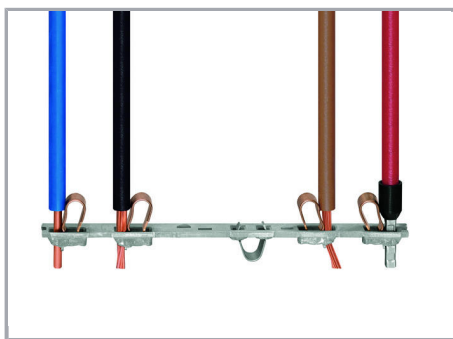

All conductor types at a glance

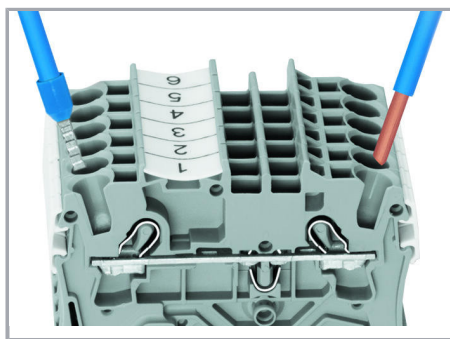

Terminating solid and ferruled conductors via push-in connection.

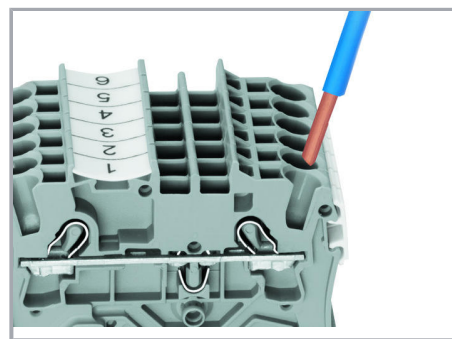

Inserting conductors via push-in termination.

Solid conductors with cross-sections from either one size above, or up to two sizes below, the rated cross-section can be simply pushed in – no tools needed.

Подлежи на промяна. Моля, обърнете внимание и на допълнителната документация на продукта!

ВАГО България ООД
Бизнес център Сердика
Бул."Акад. Иван Гешов" 2Е | Сграда 1, ет. 4, офис 417 | 1330 София
Тел.: +359 2 489 46 09 | Тел.: +359 2 489 46 10
Имейл: sales.bg@wago.com

Имате ли въпроси относно нашите продукти?
Винаги ще се радваме да получим вашето обаждане на +359 2 489 46 09.

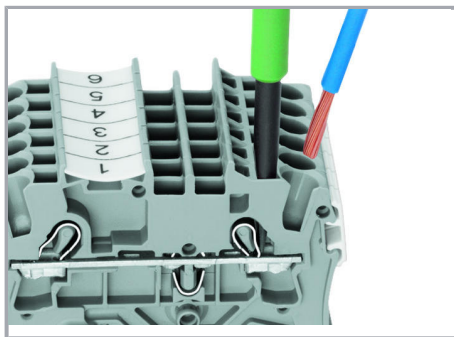

Inserting a conductor via operating tool.

Connecting fine-stranded conductors without ferrules, or small cross-sectional conductors that cannot be pushed in, is performed similarly to the original CAGE CLAMP® – just use an operating tool.

The smart feature:

To open the clamp, the operating tool is inserted vertically. The conductor entry is less than 15 degrees for easier wiring.

Commoning

Подлежи на промяна. Моля, обърнете внимание и на допълнителната документация на продукта!

ВАГО България ООД
Бизнес център Сердика
Бул."Акад. Иван Гешов" 2Е | Сграда 1, ет. 4, офис 417 | 1330 София
Тел.: +359 2 489 46 09 | Тел.: +359 2 489 46 10
Имейл: sales.bg@wago.com

Имате ли въпроси относно нашите продукти?
Винаги ще се радваме да получим вашето обаждане на +359 2 489 46 09.

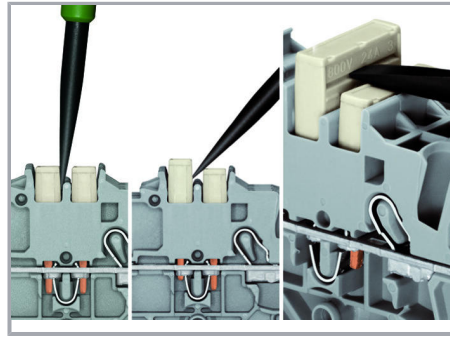
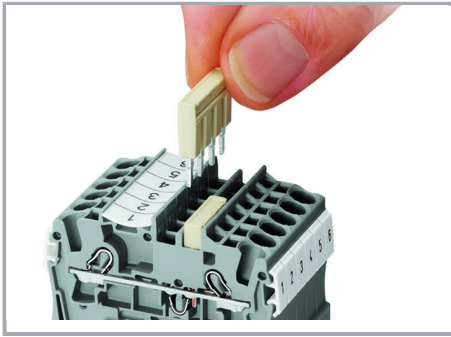

The push-in type jumper bar system is based on the common plug and socket principle. Each terminal block is spring-loaded with a double socket and a resilient CrNi steel spring. The jumper contact material is pure electrolytic copper, which allows for an extremely small design capable of carrying the full-rated current of the terminal block. Ground terminal blocks can also be commoned using the same jumper system. Custom jumpers are created by breaking and removing jumper contacts (2000, 2001, 2002, 2004 Series).

Removing a push-in type jumper bar.

Insert the operating tool between the jumper and the partition wall of the dual jumper slots, then lift up the jumper.

Place the operating tool in the center of jumpers up to five contacts (see above), or alternately on both sides for jumpers with more than five contacts.

Commoning

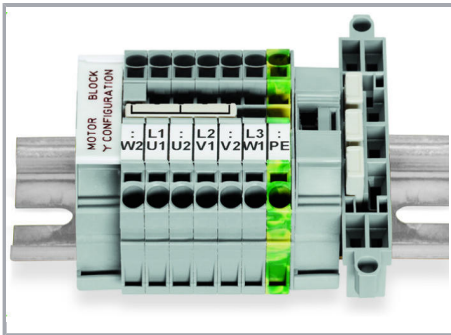

This star point jumper has been specially developed to create a "star point" and is used on motor terminal boards equipped with TOPJOB® S rail-mount terminal blocks.

Commoning

Подлежи на промяна. Моля, обърнете внимание и на допълнителната документация на продукта!

ВАГО България ООД
Бизнес център Сердика
Бул."Акад. Иван Гешов" 2Е | Сграда 1, ет. 4, офис 417 | 1330 София
Тел.: +359 2 489 46 09 | Тел.: +359 2 489 46 10
Имейл: sales.bg@wago.com

Имате ли въпроси относно нашите продукти?
Винаги ще се радваме да получим вашето обаждане на +359 2 489 46 09.

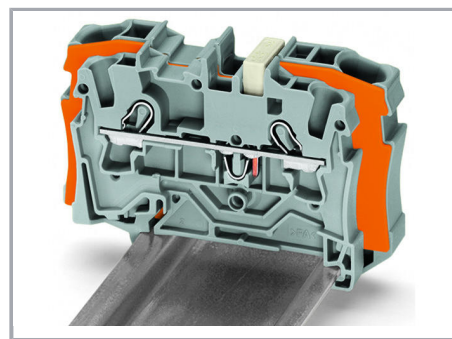
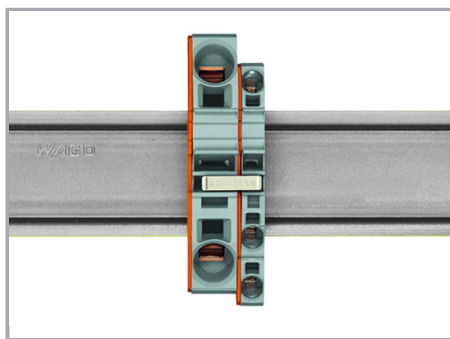
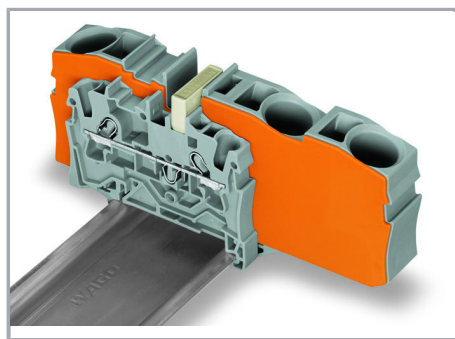

Step-down jumpers may common terminal blocks of different sizes, without losing a conductor clamping point. This can be beneficial on long conductor runs where voltage drops may be problematic. A large conductor can be easily connected to smaller conductors at the distribution point.

Using step-down jumpers, an end plate must be inserted between the terminal blocks to be commoned.

Step-down jumper (2006-499) commons 6 /4 mm² (10/12 AWG) terminal blocks (2006 /2004 Series) with 4/2.5/1.5 mm² (12/14/16 AWG) terminal blocks (2004/2002/2001 Series).

Commoning may be made in either direction using the special thin end plate to cover the open side. Additional through terminal blocks having a smaller cross-section may be commoned using push-in type jumper bars.

Подлежи на промяна. Моля, обърнете внимание и на допълнителната документация на продукта!

ВАГО България ООД
Бизнес център Сердика
Бул."Акад. Иван Гешов" 2Е | Сграда 1, ет. 4, офис 417 | 1330 София
Тел.: +359 2 489 46 09 | Тел.: +359 2 489 46 10
Имейл: sales.bg@wago.com

Имате ли въпроси относно нашите продукти?
Винаги ще се радваме да получим вашето обаждане на +359 2 489 46 09.

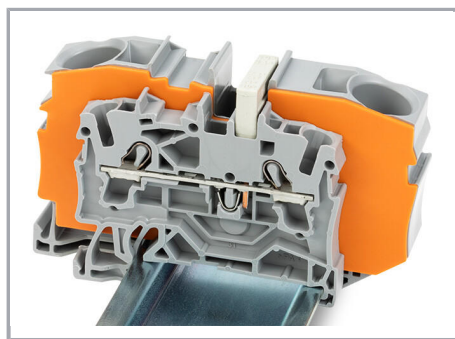

Step-down jumper (2016-499) commons 16 /10 mm² (16/8 AWG) terminal blocks (2016 /2010 Series) with 10/6/4/2.5 mm² (8/10/12 /14 AWG) terminal blocks (2010/2006/2004 /2002 Series).

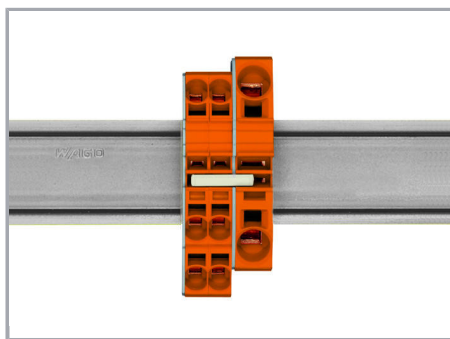

Stepping down via push-in type jumper bar.

Commoning via open terminal side with end plate allows jumpering over two cross-section sizes for 16 mm² (6 AWG) and 10 mm² (8 AWG) and one cross-section size for 6/4/2.5 mm² (10/12/14 AWG). An example: from 16 mm² (6 AWG) to 6 mm² (10 AWG) (see illustration above) or from 10 mm² (8 AWG) to 4 mm² (12 AWG).

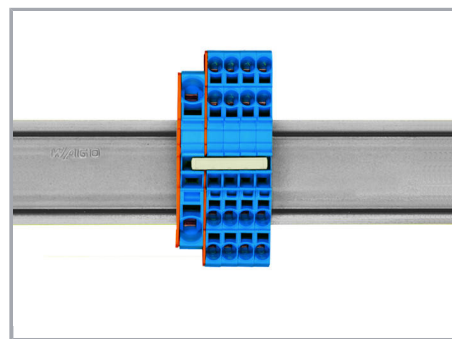

Stepping down via push-in type jumper bar.

Commoning via closed terminal side with end plate allows jumpering over two cross-section sizes, e.g., from 16 mm² (6 AWG) to 6 mm² (10 AWG) or from 6 mm² (10 AWG) to 2.5 mm² (14 AWG) (see illustration above).

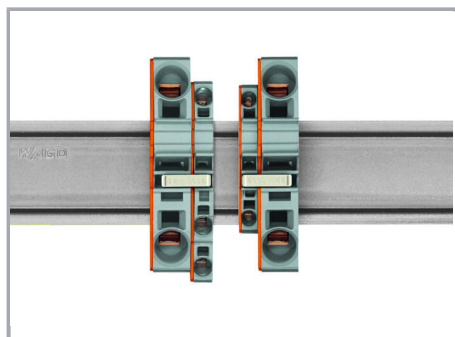

Note:

The total current of the outgoing circuits shall not exceed the nominal current of the step-down jumper/push-in type jumper bar.

Testing

Подлежи на промяна. Моля, обърнете внимание и на допълнителната документация на продукта!

ВАГО България ООД
 Бизнес център Сердика
 Бул."Акад. Иван Гешов" 2Е | Сграда 1, ет. 4, офис 417 | 1330 София
 Тел.: +359 2 489 46 09 | Тел.: +359 2 489 46 10
 Имейл: sales.bg@wago.com

Имате ли въпроси относно нашите продукти?
 Винаги ще се радваме да получим вашето обаждане на +359 2 489 46 09.

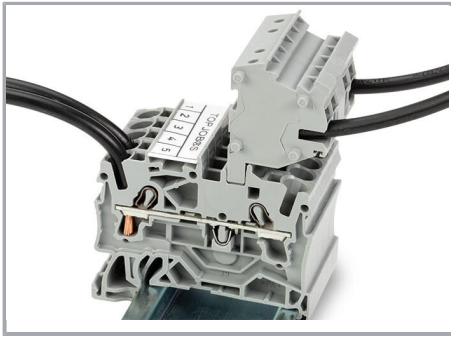

The modular TOPJOB® S connectors also connect conductors of the same size as the terminal blocks being used.

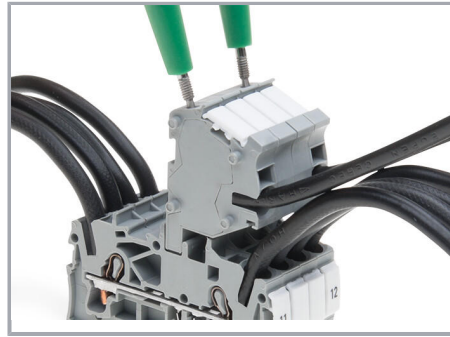

TOPJOB® S Connectors with a 2 mm Ø test socket for testing voltage via 2-pole voltage tester

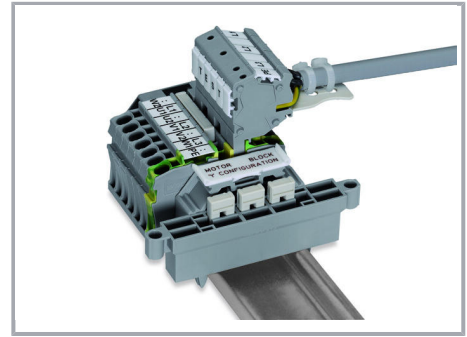

Rail-mount terminal block assembly for electric motor wiring

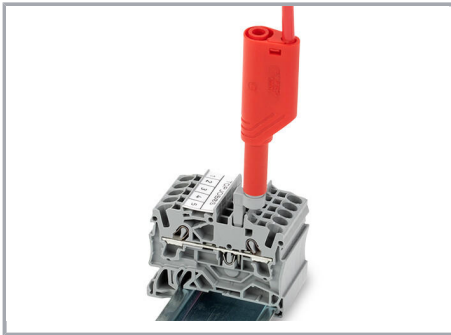

Test plug adapter (2009-174, CAT I) for 4 mm Ø plugs – compatible with 2000 to 2016 Series

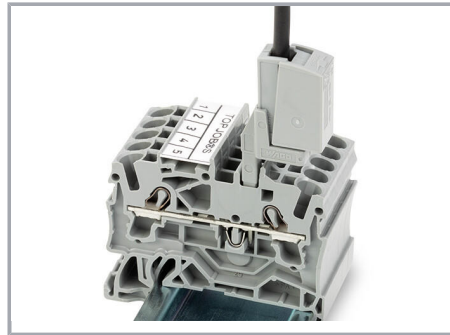

Testing tap (2009-182) for tool-free connection of test cables up to 2.5 mm² (12 AWG) – compatible with 2000 to 2016 Series

Marking

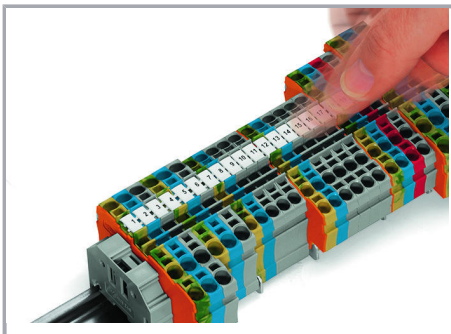

Snapping WMB Inline markers into marker slots.

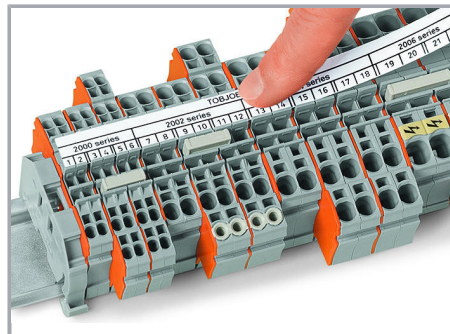

Подлежи на промяна. Моля, обърнете внимание и на допълнителната документация на продукта!

ВАГО България ООД
Бизнес център Сердика
Бул."Акад. Иван Гешов" 2Е | Сграда 1, ет. 4, офис 417 | 1330 София
Тел.: +359 2 489 46 09 | Тел.: +359 2 489 46 10
Имейл: sales.bg@wago.com

Имате ли въпроси относно нашите продукти?
Винаги ще се радваме да получим вашето обаждане на +359 2 489 46 09.

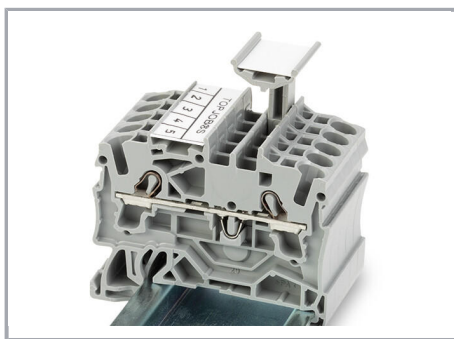

TOPJOB® S 2009-193 Group Marker Carrier (equipped with a marking strip) for all 2001 to 2016 Series TOPJOB® S Rail-Mount Terminal Blocks

Do not use on an end plate!

Ex application

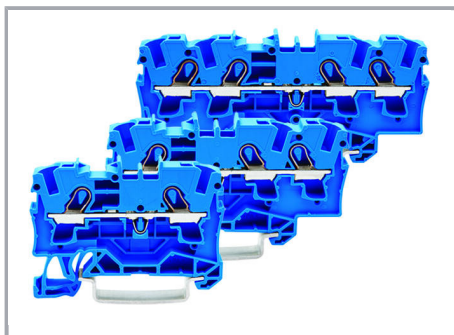

Through terminal blocks with a blue insulated housing are suitable for Ex i applications.



All through and ground conductor terminal blocks are suitable for Ex e II applications.

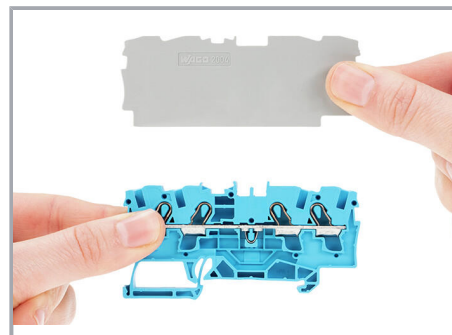

Separator for Ex e/Ex applications

An end plate must be applied to the terminal block located directly behind an Ex e/Ex i separator plate.

Подлежи на промяна. Моля, обърнете внимание и на допълнителната документация на продукта!

ВАГО България ООД
Бизнес център Сердика
Бул."Акад. Иван Гешов" 2Е | Сграда 1, ет. 4, офис 417 | 1330 София
Тел.: +359 2 489 46 09 | Тел.: +359 2 489 46 10
Имейл: sales.bg@wago.com

Имате ли въпроси относно нашите продукти?
Винаги ще се радваме да получим вашето обаждане на +359 2 489 46 09.

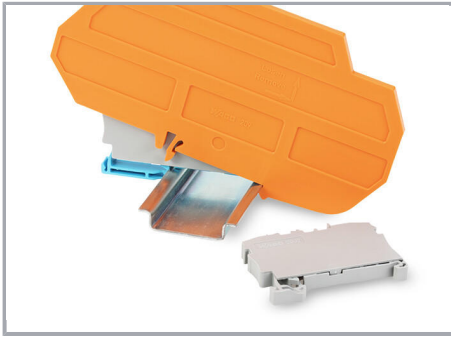

Ex e II/Ex i terminal strip

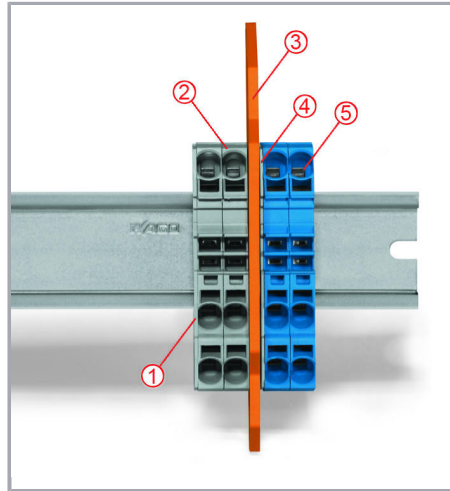

Notice:

The movable feet of terminal blocks and separator plates must face the same direction.

Separator located between Ex e II and Ex i terminal strip

End plate

Ex e II terminal blocks

Separator for Ex e/Ex i applications

End plate

Ex i terminal blocks

According to EN 50020, a minimum distance of 50 mm must be kept between live parts of Ex e and Ex i circuits. The use of Ex e/Ex i separators is a space-saving solution when Ex e and Ex i terminal blocks are mounted on a common carrier rail.

Семейство продукти

TOPJOB® S

Подлежи на промяна. Моля, обърнете внимание и на допълнителната документация на продукта!

ВАГО България ООД
Бизнес център Сердика
Бул."Акад. Иван Гешов" 2Е | Сграда 1, ет. 4, офис 417 | 1330 София
Тел.: +359 2 489 46 09 | Тел.: +359 2 489 46 10
Имейл: sales.bg@wago.com

Имате ли въпроси относно нашите продукти?
Винаги ще се радваме да получим вашето обаждане на +359 2 489 46 09.



TOPJOB® S: In various industrial applications and modern building installations, WAGO's wide and versatile range of rail-mount terminal blocks provides more than just reliable electrical connections.

Показване на всички продукти от семейството.

Подлежи на промяна. Моля, обърнете внимание и на допълнителната документация на продукта!

ВАГО България ООД
Бизнес център Сердика
Бул."Акад. Иван Гешов" 2Е | Сграда 1, ет. 4, офис 417 | 1330 София
Тел.: +359 2 489 46 09 | Тел.: +359 2 489 46 10
Имейл: sales.bg@wago.com

Имате ли въпроси относно нашите продукти?
Винаги ще се радваме да получим вашето обаждане на +359 2 489 46 09.