

## Информационен лист | Номер на артикул: 2004-1204

2-conductor through terminal block; 4 mm<sup>2</sup>; for Ex e II and Ex i applications;  
side and center marking; for DIN-rail 35 x 15 and 35 x 7.5; Push-in CAGE  
CLAMP®; 4,00 mm<sup>2</sup>; blue

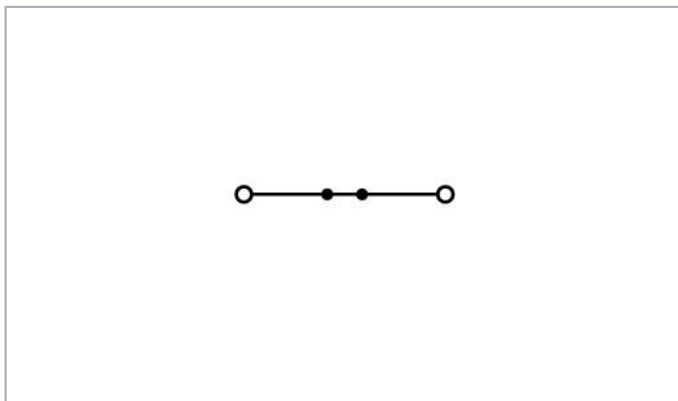

[www.wago.com/2004-1204](http://www.wago.com/2004-1204)

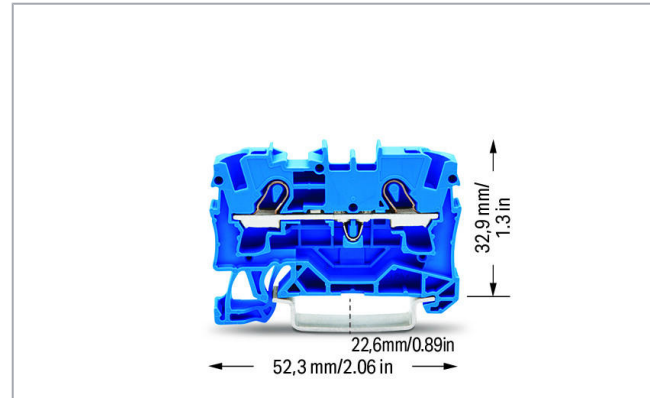
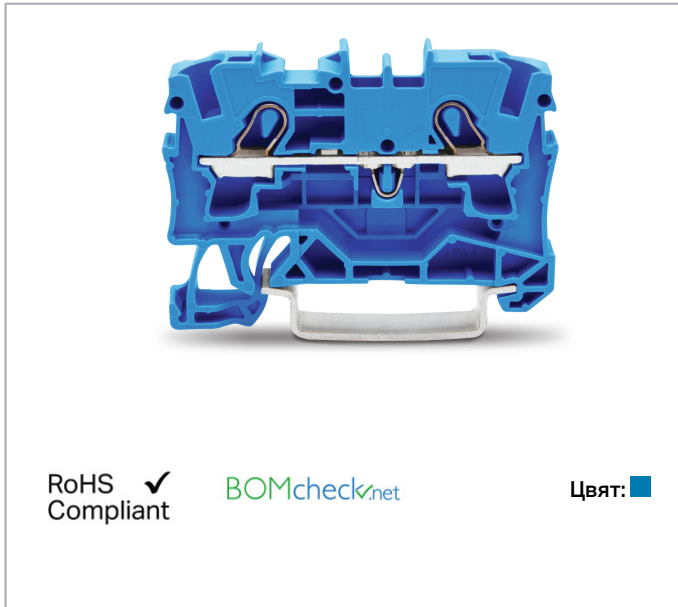

### Данни Electrical data

#### Ratings per IEC/EN 60664-1

Ratings per	IEC/EN 60947-7-1
Nominal voltage (III/3)	800 V
Rated surge voltage (III/3)	8 kV
Rated current	32 A

Подлежи на промяна. Моля, обърнете внимание и на допълнителната документация на продукта!

ВАГО България ООД  
Бизнес център Сердика  
Бул."Акад. Иван Гешов" 2Е | Сграда 1, ет. 4, офис 417 | 1330 София  
Тел.: +359 2 489 46 09 | Тел.: +359 2 489 46 10  
Имейл: [sales.bg@wago.com](mailto:sales.bg@wago.com)

Имате ли въпроси относно нашите продукти?  
Винаги ще се радваме да получим вашето обаждане на +359 2 489 46 09.



Rated current 2	41 A
Legend (ratings)	(III / 3) $\triangle$ Overvoltage category III / Pollution degree 3

### Ratings per UL 1059

Approvals per	UL 1059
Rated voltage UL (Use Group B)	600 V
Rated current UL (Use Group B)	30 A
Rated voltage UL (Use Group C)	600 V
Rated current UL (Use Group C)	30 A

### Ratings per CSA

Rated voltage CSA (Use Group B)	600 V
Rated current CSA (Use Group B)	30 A
Rated voltage CSA (Use Group C)	600 V
Rated current CSA (Use Group C)	30 A

### Ex information

Rated voltage EN (Ex e II)	550 V
Rated current (Ex e II)	30 A

### Connection data

Connection technology	Push-in CAGE CLAMP <sup>®</sup>
Actuation type	Push-in Operating tool
Connectable conductor materials	Copper
Nominal cross-section	4 mm <sup>2</sup>
Solid conductor	0,5 ... 6 mm <sup>2</sup> / 20 ... 10 AWG
Solid conductor; push-in termination	1,5 ... 6 mm <sup>2</sup> / 14 ... 10 AWG
Fine-stranded conductor	0,5 ... 6 mm <sup>2</sup> / 20 ... 10 AWG
Fine-stranded conductor; with insulated ferrule	1,5 ... 4 mm <sup>2</sup> / 18 ... 12 AWG
Fine-stranded conductor; with ferrule; push-in termination	1,5 ... 4 mm <sup>2</sup> / 18 ... 12 AWG
Note (conductor cross-section)	Depending on the conductor characteristic, a conductor with a smaller cross-section can also be inserted via push-in termination.
Strip length	11 ... 13 mm / 0.43 ... 0.51 inch
Total number of connection points	2
Total number of potentials	1
Number of levels	1

Подлежи на промяна. Моля, обърнете внимание и на допълнителната документация на продукта!

ВАГО България ООД  
 Бизнес център Сердика  
 Бул."Акад. Иван Гешов" 2Е | Сграда 1, ет. 4, офис 417 | 1330 София  
 Тел.: +359 2 489 46 09 | Тел.: +359 2 489 46 10  
 Имейл: [sales.bg@wago.com](mailto:sales.bg@wago.com)

Имате ли въпроси относно нашите продукти?  
 Винаги ще се радваме да получим вашето обаждане на +359 2 489 46 09.



Wiring type	Front-entry wiring
Number of jumper slots	2

**Physical data**

Width	6,2 mm / 0.244 inch
Height from upper-edge of DIN-rail	32,9 mm / 1.295 inch
Depth	52,3 mm / 2.059 inch

**Mechanical data**

Design	horizontal type
Mounting type	DIN-35 rail
Marking level	Center/side marking



**Material Data**

Color	blue
Insulation material	Polyamide (PA66)
Fire load	0,114 MJ
Weight	6,3 g

**Commercial data**

Product Group	22 (TOPJOB S)
Packaging type	BOX
Country of origin	DE
GTIN	4017332071086
Customs tariff number	85369010000

**Одобрения / Сертификати****Ex-Approvals**

Лого	Одобрение	Допълнителен текст за одобрение	Име на сертификат
	AEx Underwriters Laboratories Inc.	EN 60079	E185892
	ATEX Physikalisch Technische Bundesanstalt (PTB)	EN 60079	PTB 05 ATEX 1095 U (II 2 G/D Ex eII bzw. I M2 Ex el)
	CCCEX	CNCA-C23-01	2020312313000160

Подлежи на промяна. Моля, обърнете внимание и на допълнителната документация на продукта!





ВАГО България ООД  
Бизнес център Сердика  
Бул."Акад. Иван Гешов" 2Е | Сграда 1, ет. 4, офис 417 | 1330 София  
Тел.: +359 2 489 46 09 | Тел.: +359 2 489 46 10  
Имейл: [sales.bg@wago.com](mailto:sales.bg@wago.com)

Имате ли въпроси относно нашите продукти?  
Винаги ще се радваме да получим вашето обаждане на +359 2 489 46 09.





CQST/CNEx

## Country specific Approvals

Лого	Одобрение	Допълнителен текст за одобрение	Име на сертификат
	CCA DEKRA Certification B.V.	EN 60947	2160584.10
	CCA DEKRA Certification B.V.	EN 60947	NTR NL-7088
	CSA DEKRA Certification B.V.	C22.2 No. 158	1645435
	EAC Brjansker Zertifizierungsstelle	TP TC 012/2011	RU C-DE. AM02.B. 00127/19

## Ship Approvals

Лого	Одобрение	Допълнителен текст за одобрение	Име на сертификат
	ABS American Bureau of Shipping	-	20- HG1941090- PDA
	BV Bureau Veritas S.A.	EN 60947	38586/A0 BV
	LR Lloyds Register	EN 60947	91/20112 (E9)

## UL-Approvals

Лого	Одобрение	Допълнителен текст за одобрение	Име на сертификат

Подлежи на промяна. Моля, обърнете внимание и на допълнителната документация на продукта!

ВАГО България ООД  
Бизнес център Сердика  
Бул."Акад. Иван Гешов" 2Е | Сграда 1, ет. 4, офис 417 | 1330 София  
Тел.: +359 2 489 46 09 | Тел.: +359 2 489 46 10  
Имейл: sales.bg@wago.com

Имате ли въпроси относно нашите продукти?  
Винаги ще се радваме да получим вашето обаждане на +359 2 489 46 09.





UL  
UL International Germany GmbH

UL 1059

E45172



## Изискват се аксесоари

### End plate

	<b>Артикул №: 2004-1291</b> End and intermediate plate; 1 mm thick; gray	<a href="http://www.wago.com/2004-1291">www.wago.com/2004-1291</a>
	<b>Артикул №: 2004-1292</b> End and intermediate plate; 1 mm thick; orange	<a href="http://www.wago.com/2004-1292">www.wago.com/2004-1292</a>

## Съвместими продукти

### Jumper



	<b>Артикул №: 2004-402</b> Jumper; 2-way; insulated; light gray	<a href="http://www.wago.com/2004-402">www.wago.com/2004-402</a>
	<b>Артикул №: 2004-403</b> Jumper; 3-way; insulated; light gray	<a href="http://www.wago.com/2004-403">www.wago.com/2004-403</a>
	<b>Артикул №: 2004-404</b> Jumper; 4-way; insulated; light gray	<a href="http://www.wago.com/2004-404">www.wago.com/2004-404</a>
	<b>Артикул №: 2004-405</b> Jumper; 5-way; insulated; light gray	<a href="http://www.wago.com/2004-405">www.wago.com/2004-405</a>
	<b>Артикул №: 2004-405/011-000</b> Star point jumper; 3-way; insulated; light gray	<a href="http://www.wago.com/2004-405/011-000">www.wago.com/2004-405/011-000</a>
	<b>Артикул №: 2004-406</b> Jumper; 6-way; insulated; light gray	<a href="http://www.wago.com/2004-406">www.wago.com/2004-406</a>
	<b>Артикул №: 2004-406/020-000</b> Delta jumper; insulated; light gray	<a href="http://www.wago.com/2004-406/020-000">www.wago.com/2004-406/020-000</a>
	<b>Артикул №: 2004-407</b> Jumper; 7-way; insulated; light gray	<a href="http://www.wago.com/2004-407">www.wago.com/2004-407</a>
	<b>Артикул №: 2004-408</b> Jumper; 8-way; insulated; light gray	<a href="http://www.wago.com/2004-408">www.wago.com/2004-408</a>
	<b>Артикул №: 2004-409</b> Jumper; 9-way; insulated; light gray	<a href="http://www.wago.com/2004-409">www.wago.com/2004-409</a>

**Артикул №: 2004-410**

Подлежи на промяна. Моля, обърнете внимание и на допълнителната документация на продукта!

ВАГО България ООД  
 Бизнес център Сердика  
 Бул."Акад. Иван Гешов" 2Е | Сграда 1, ет. 4, офис 417 | 1330 София  
 Тел.: +359 2 489 46 09 | Тел.: +359 2 489 46 10  
 Имейл: [sales.bg@wago.com](mailto:sales.bg@wago.com)

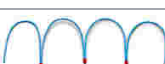
Имате ли въпроси относно нашите продукти?  
 Винаги ще се радваме да получим вашето обаждане на +359 2 489 46 09.

	Jumper; 10-way; insulated; light gray	<a href="http://www.wago.com/2004-410">www.wago.com/2004-410</a>
	<b>Артикул №: 2004-433</b> Jumper; from 1 to 3; insulated; light gray	<a href="http://www.wago.com/2004-433">www.wago.com/2004-433</a>
	<b>Артикул №: 2004-434</b> Jumper; from 1 to 4; insulated; light gray	<a href="http://www.wago.com/2004-434">www.wago.com/2004-434</a>
	<b>Артикул №: 2004-435</b> Jumper; from 1 to 5; insulated; light gray	<a href="http://www.wago.com/2004-435">www.wago.com/2004-435</a>
	<b>Артикул №: 2004-436</b> Jumper; from 1 to 6; insulated; light gray	<a href="http://www.wago.com/2004-436">www.wago.com/2004-436</a>
	<b>Артикул №: 2004-437</b> Jumper; from 1 to 7; insulated; light gray	<a href="http://www.wago.com/2004-437">www.wago.com/2004-437</a>
	<b>Артикул №: 2004-438</b> Jumper; from 1 to 8; insulated; light gray	<a href="http://www.wago.com/2004-438">www.wago.com/2004-438</a>
	<b>Артикул №: 2004-439</b> Jumper; from 1 to 9; insulated; light gray	<a href="http://www.wago.com/2004-439">www.wago.com/2004-439</a>
	<b>Артикул №: 2004-440</b> Jumper; from 1 to 10; insulated; light gray	<a href="http://www.wago.com/2004-440">www.wago.com/2004-440</a>
	<b>Артикул №: 2006-499</b> Step-down jumper; insulated; light gray	<a href="http://www.wago.com/2006-499">www.wago.com/2006-499</a>
	<b>Артикул №: 2016-499</b> Step-down jumper; insulated; light gray	<a href="http://www.wago.com/2016-499">www.wago.com/2016-499</a>
	<b>Артикул №: 210-103</b> Wire commoning chain; insulated; black	<a href="http://www.wago.com/210-103">www.wago.com/210-103</a>
	<b>Артикул №: 210-123</b> Wire commoning chain; insulated; blue	<a href="http://www.wago.com/210-123">www.wago.com/210-123</a>
<b>Carrier rail</b>		
	<b>Артикул №: 210-112</b> Steel carrier rail; 35 x 7.5 mm; 1 mm thick; 2 m long; slotted; according to EN 60715; "Hole width 25 mm; silver-colored	<a href="http://www.wago.com/210-112">www.wago.com/210-112</a>
	<b>Артикул №: 210-113</b> Steel carrier rail; 35 x 7.5 mm; 1 mm thick; 2 m long; unslotted; according to EN 60715; silver-colored	<a href="http://www.wago.com/210-113">www.wago.com/210-113</a>
	<b>Артикул №: 210-114</b> Steel carrier rail; 35 x 15 mm; 1.5 mm thick; 2 m long; unslotted; similar to EN 60715; silver-colored	<a href="http://www.wago.com/210-114">www.wago.com/210-114</a>
	<b>Артикул №: 210-115</b> Steel carrier rail; 35 x 7.5 mm; 1 mm thick; 2 m long; slotted; according to EN 60715; "Hole width 18 mm; silver-colored	<a href="http://www.wago.com/210-115">www.wago.com/210-115</a>

Подлежи на промяна. Моля, обърнете внимание и на допълнителната документация на продукта!

ВАГО България ООД  
 Бизнес център Сердика  
 Бул."Акад. Иван Гешов" 2Е | Сграда 1, ет. 4, офис 417 | 1330 София  
 Тел.: +359 2 489 46 09 | Тел.: +359 2 489 46 10  
 Имейл: [sales.bg@wago.com](mailto:sales.bg@wago.com)















Имате ли въпроси относно нашите продукти?  
 Винаги ще се радваме да получим вашето обаждане на +359 2 489 46 09.

	<b>Артикул №: 210-118</b> Steel carrier rail; 35 x 15 mm; 2.3 mm thick; 2 m long; unslotted; according to EN 60715; silver-colored	<a href="http://www.wago.com/210-118">www.wago.com/210-118</a>
	<b>Артикул №: 210-196</b> Aluminum carrier rail; 35 x 8.2 mm; 1.6 mm thick; 2 m long; unslotted; similar to EN 60715; silver-colored	<a href="http://www.wago.com/210-196">www.wago.com/210-196</a>
	<b>Артикул №: 210-197</b> Steel carrier rail; 35 x 15 mm; 1.5 mm thick; 2 m long; slotted; similar to EN 60715; silver-colored	<a href="http://www.wago.com/210-197">www.wago.com/210-197</a>
	<b>Артикул №: 210-198</b> Copper carrier rail; 35 x 15 mm; 2.3 mm thick; 2 m long; unslotted; according to EN 60715; copper-colored	<a href="http://www.wago.com/210-198">www.wago.com/210-198</a>
	<b>Артикул №: 210-504</b> Steel carrier rail; 35 x 7.5 mm; 1 mm thick; 2 m long; slotted; galvanized; according to EN 60715	<a href="http://www.wago.com/210-504">www.wago.com/210-504</a>
	<b>Артикул №: 210-505</b> Steel carrier rail; 35 x 7.5 mm; 1 mm thick; 2 m long; unslotted; galvanized; according to EN 60715; silver-colored	<a href="http://www.wago.com/210-505">www.wago.com/210-505</a>
	<b>Артикул №: 210-506</b> Steel carrier rail; 35 x 15 mm; 1.5 mm thick; 2 m long; unslotted; galvanized; similar to EN 60715; silver-colored	<a href="http://www.wago.com/210-506">www.wago.com/210-506</a>
	<b>Артикул №: 210-508</b> Steel carrier rail; 35 x 15 mm; 1.5 mm thick; 2 m long; slotted; galvanized; similar to EN 60715; silver-colored	<a href="http://www.wago.com/210-508">www.wago.com/210-508</a>
<b>tools</b>		
	<b>Артикул №: 210-658</b> Operating tool; Blade: 3.5 x 0.5 mm; with a partially insulated shaft; angled; short; multicoloured	<a href="http://www.wago.com/210-658">www.wago.com/210-658</a>
	<b>Артикул №: 210-720</b> Operating tool; Blade: 3.5 x 0.5 mm; with a partially insulated shaft; multicoloured	<a href="http://www.wago.com/210-720">www.wago.com/210-720</a>
<b>Insulation stop</b>		
	<b>Артикул №: 2004-171</b> Insulation stop; 0.25 - 0.5 mm <sup>2</sup> ; 5 pieces/strip; light gray	<a href="http://www.wago.com/2004-171">www.wago.com/2004-171</a>
	<b>Артикул №: 2004-172</b> Insulation stop; 0.75 - 1 mm <sup>2</sup> ; 5 pieces/strip; dark gray	<a href="http://www.wago.com/2004-172">www.wago.com/2004-172</a>
<b>check</b>		
	<b>Артикул №: 2004-511</b> Modular TOPJOB®S connector; modular; for jumper contact slot; 1-pole; 4,00 mm <sup>2</sup> ; gray	<a href="http://www.wago.com/2004-511">www.wago.com/2004-511</a>
	<b>Артикул №: 2004-549</b> Spacer module; modular; e.g., for bridging commoned terminal blocks; gray	<a href="http://www.wago.com/2004-549">www.wago.com/2004-549</a>
	<b>Артикул №: 2004-552</b> Modular TOPJOB®S connector; modular; for jumper contact slot; 2-pole; 4,00 mm <sup>2</sup> ; gray	<a href="http://www.wago.com/2004-552">www.wago.com/2004-552</a>
	<b>Артикул №: 2004-553</b> Modular TOPJOB®S connector; modular; for jumper contact slot; 3-pole; 4,00 mm <sup>2</sup> ; gray	<a href="http://www.wago.com/2004-553">www.wago.com/2004-553</a>

Подлежи на промяна. Моля, обърнете внимание и на допълнителната документация на продукта!

ВАГО България ООД  
Бизнес център Сердика  
Бул."Акад. Иван Гешов" 2Е | Сграда 1, ет. 4, офис 417 | 1330 София  
Тел.: +359 2 489 46 09 | Тел.: +359 2 489 46 10  
Имейл: [sales.bg@wago.com](mailto:sales.bg@wago.com)















Имате ли въпроси относно нашите продукти?  
Винаги ще се радваме да получим вашето обаждане на +359 2 489 46 09.

	<b>Артикул №: 2004-554</b> Modular TOPJOB®S connector; modular; for jumper contact slot; 4-pole; 4,00 mm <sup>2</sup> ; gray	<a href="http://www.wago.com/2004-554">www.wago.com/2004-554</a>
	<b>Артикул №: 2004-555</b> Modular TOPJOB®S connector; modular; for jumper contact slot; 5-pole; 4,00 mm <sup>2</sup> ; gray	<a href="http://www.wago.com/2004-555">www.wago.com/2004-555</a>
	<b>Артикул №: 2009-174</b> Test plug adapter; for 4 mm Ø test plugs; for testing TOPJOB®S rail-mounted terminal blocks; gray	<a href="http://www.wago.com/2009-174">www.wago.com/2009-174</a>
	<b>Артикул №: 2009-182</b> Testing tap; for max. 2.5 mm <sup>2</sup> ; tool-free connection for individual test wires 0.08 - 2.5 mm; gray	<a href="http://www.wago.com/2009-182">www.wago.com/2009-182</a>
<b>Marking accessories</b>		
	<b>Артикул №: 2009-110</b> Marking strips; for Smart Printer; on reel; not stretchable; plain; snap-on type; white	<a href="http://www.wago.com/2009-110">www.wago.com/2009-110</a>
	<b>Артикул №: 2009-115</b> WMB-Inline; for Smart Printer; 1500 pieces on roll; stretchable 5 - 5.2 mm; plain; snap-on type; white	<a href="http://www.wago.com/2009-115">www.wago.com/2009-115</a>
	<b>Артикул №: 2009-115/000-002</b> WMB-Inline; for Smart Printer; 1500 pieces on roll; stretchable 5 - 5.2 mm; plain; snap-on type; yellow	<a href="http://www.wago.com/2009-115/000-002">www.wago.com/2009-115/000-002</a>
	<b>Артикул №: 2009-115/000-005</b> WMB-Inline; for Smart Printer; 1500 pieces on roll; stretchable 5 - 5.2 mm; plain; snap-on type; red	<a href="http://www.wago.com/2009-115/000-005">www.wago.com/2009-115/000-005</a>
	<b>Артикул №: 2009-115/000-006</b> WMB-Inline; for Smart Printer; 1500 pieces on roll; stretchable 5 - 5.2 mm; plain; snap-on type; blue	<a href="http://www.wago.com/2009-115/000-006">www.wago.com/2009-115/000-006</a>
	<b>Артикул №: 2009-115/000-007</b> WMB-Inline; for Smart Printer; 1500 pieces on roll; stretchable 5 - 5.2 mm; plain; snap-on type; gray	<a href="http://www.wago.com/2009-115/000-007">www.wago.com/2009-115/000-007</a>
	<b>Артикул №: 2009-115/000-012</b> WMB-Inline; for Smart Printer; 1500 pieces on roll; stretchable 5 - 5.2 mm; plain; snap-on type; orange	<a href="http://www.wago.com/2009-115/000-012">www.wago.com/2009-115/000-012</a>
	<b>Артикул №: 2009-115/000-017</b> WMB-Inline; for Smart Printer; 1500 pieces on roll; stretchable 5 - 5.2 mm; plain; snap-on type; light green	<a href="http://www.wago.com/2009-115/000-017">www.wago.com/2009-115/000-017</a>
	<b>Артикул №: 2009-115/000-023</b> WMB-Inline; for Smart Printer; 1500 pieces on roll; stretchable 5 - 5.2 mm; plain; snap-on type; green	<a href="http://www.wago.com/2009-115/000-023">www.wago.com/2009-115/000-023</a>
	<b>Артикул №: 2009-115/000-024</b> WMB-Inline; for Smart Printer; 1500 pieces on roll; stretchable 5 - 5.2 mm; plain; snap-on type; violet	<a href="http://www.wago.com/2009-115/000-024">www.wago.com/2009-115/000-024</a>
	<b>Артикул №: 2009-145</b> Mini-WSB Inline; for Smart Printer; 1700 pieces on roll; stretchable 5 - 5.2 mm; plain; snap-on type; white	<a href="http://www.wago.com/2009-145">www.wago.com/2009-145</a>

Подлежи на промяна. Моля, обърнете внимание и на допълнителната документация на продукта!

ВАГО България ООД  
Бизнес център Сердика  
Бул."Акад. Иван Гешов" 2Е | Сграда 1, ет. 4, офис 417 | 1330 София  
Тел.: +359 2 489 46 09 | Тел.: +359 2 489 46 10  
Имейл: [sales.bg@wago.com](mailto:sales.bg@wago.com)

Имате ли въпроси относно нашите продукти?  
Винаги ще се радваме да получим вашето обаждане на +359 2 489 46 09.

	<b>Артикул №: 2009-145/000-002</b> Mini-WSB Inline; for Smart Printer; 1700 pieces on roll; stretchable 5 - 5.2 mm; plain; snap-on type; yellow	<a href="http://www.wago.com/2009-145/000-002">www.wago.com/2009-145/000-002</a>
	<b>Артикул №: 2009-145/000-005</b> Mini-WSB Inline; for Smart Printer; 1700 pieces on roll; stretchable 5 - 5.2 mm; plain; snap-on type; red	<a href="http://www.wago.com/2009-145/000-005">www.wago.com/2009-145/000-005</a>
	<b>Артикул №: 2009-145/000-006</b> Mini-WSB Inline; for Smart Printer; 1700 pieces on roll; stretchable 5 - 5.2 mm; plain; snap-on type; blue	<a href="http://www.wago.com/2009-145/000-006">www.wago.com/2009-145/000-006</a>
	<b>Артикул №: 2009-145/000-007</b> Mini-WSB Inline; for Smart Printer; 1700 pieces on roll; stretchable 5 - 5.2 mm; plain; snap-on type; gray	<a href="http://www.wago.com/2009-145/000-007">www.wago.com/2009-145/000-007</a>
	<b>Артикул №: 2009-145/000-012</b> Mini-WSB Inline; for Smart Printer; 1700 pieces on roll; stretchable 5 - 5.2 mm; plain; snap-on type; orange	<a href="http://www.wago.com/2009-145/000-012">www.wago.com/2009-145/000-012</a>
	<b>Артикул №: 2009-145/000-023</b> Mini-WSB Inline; for Smart Printer; 1700 pieces on roll; stretchable 5 - 5.2 mm; plain; snap-on type; green	<a href="http://www.wago.com/2009-145/000-023">www.wago.com/2009-145/000-023</a>
	<b>Артикул №: 2009-145/000-024</b> Mini-WSB Inline; for Smart Printer; 1700 pieces on roll; stretchable 5 - 5.2 mm; plain; snap-on type; violet	<a href="http://www.wago.com/2009-145/000-024">www.wago.com/2009-145/000-024</a>
	<b>Артикул №: 2009-191</b> Group marker carrier	<a href="http://www.wago.com/2009-191">www.wago.com/2009-191</a>
	<b>Артикул №: 2009-192</b> Group marker carrier	<a href="http://www.wago.com/2009-192">www.wago.com/2009-192</a>
	<b>Артикул №: 2009-193</b> Group marker carrier	<a href="http://www.wago.com/2009-193">www.wago.com/2009-193</a>
	<b>Артикул №: 2009-198</b> Adaptor; gray	<a href="http://www.wago.com/2009-198">www.wago.com/2009-198</a>
	<b>Артикул №: 248-501</b> Miniature WSB Quick marking system; plain; Marker width 5 mm; 10 strips with 10 markers per card	<a href="http://www.wago.com/248-501">www.wago.com/248-501</a>
	<b>Артикул №: 248-501/000-002</b> Mini-WSB marking card; as card; not stretchable; plain; snap-on type; yellow	<a href="http://www.wago.com/248-501/000-002">www.wago.com/248-501/000-002</a>
	<b>Артикул №: 248-501/000-005</b> Mini-WSB marking card; as card; not stretchable; plain; snap-on type; red	<a href="http://www.wago.com/248-501/000-005">www.wago.com/248-501/000-005</a>
	<b>Артикул №: 248-501/000-006</b> Mini-WSB marking card; as card; not stretchable; plain; snap-on type; blue	<a href="http://www.wago.com/248-501/000-006">www.wago.com/248-501/000-006</a>

Подлежи на промяна. Моля, обърнете внимание и на допълнителната документация на продукта!

ВАГО България ООД  
Бизнес център Сердика  
Бул."Акад. Иван Гешов" 2Е | Сграда 1, ет. 4, офис 417 | 1330 София  
Тел.: +359 2 489 46 09 | Тел.: +359 2 489 46 10  
Имейл: [sales.bg@wago.com](mailto:sales.bg@wago.com)

Имате ли въпроси относно нашите продукти?  
Винаги ще се радваме да получим вашето обаждане на +359 2 489 46 09.



**Артикул №: 248-501/000-007**  
Mini-WSB marking card; as card; not stretchable; plain; snap-on type; gray

[www.wago.com/248-501/000-007](http://www.wago.com/248-501/000-007)



**Артикул №: 248-501/000-012**  
Mini-WSB marking card; as card; not stretchable; plain; snap-on type; orange

[www.wago.com/248-501/000-012](http://www.wago.com/248-501/000-012)



**Артикул №: 248-501/000-017**  
Mini-WSB marking card; as card; not stretchable; plain; snap-on type; light green

[www.wago.com/248-501/000-017](http://www.wago.com/248-501/000-017)



**Артикул №: 248-501/000-023**  
Mini-WSB marking card; as card; not stretchable; plain; snap-on type; green

[www.wago.com/248-501/000-023](http://www.wago.com/248-501/000-023)



**Артикул №: 248-501/000-024**  
Mini-WSB marking card; as card; not stretchable; plain; snap-on type; violet

[www.wago.com/248-501/000-024](http://www.wago.com/248-501/000-024)



**Артикул №: 793-501**  
WMB marking card; as card; not stretchable; plain; snap-on type; white

[www.wago.com/793-501](http://www.wago.com/793-501)



**Артикул №: 793-501/000-002**  
WMB marking card; as card; not stretchable; plain; snap-on type; yellow

[www.wago.com/793-501/000-002](http://www.wago.com/793-501/000-002)



**Артикул №: 793-501/000-005**  
WMB marking card; as card; not stretchable; plain; snap-on type; red

[www.wago.com/793-501/000-005](http://www.wago.com/793-501/000-005)



**Артикул №: 793-501/000-006**  
WMB marking card; as card; not stretchable; plain; snap-on type; blue

[www.wago.com/793-501/000-006](http://www.wago.com/793-501/000-006)



**Артикул №: 793-501/000-007**  
WMB marking card; as card; not stretchable; plain; snap-on type; gray

[www.wago.com/793-501/000-007](http://www.wago.com/793-501/000-007)



**Артикул №: 793-501/000-012**  
WMB marking card; as card; not stretchable; plain; snap-on type; orange

[www.wago.com/793-501/000-012](http://www.wago.com/793-501/000-012)



**Артикул №: 793-501/000-017**  
WMB marking card; as card; not stretchable; plain; snap-on type; light green

[www.wago.com/793-501/000-017](http://www.wago.com/793-501/000-017)



**Артикул №: 793-501/000-023**  
WMB marking card; as card; not stretchable; plain; snap-on type; green

[www.wago.com/793-501/000-023](http://www.wago.com/793-501/000-023)

Подлежи на промяна. Моля, обърнете внимание и на допълнителната документация на продукта!

ВАГО България ООД  
Бизнес център Сердика  
Бул."Акад. Иван Гешов" 2Е | Сграда 1, ет. 4, офис 417 | 1330 София  
Тел.: +359 2 489 46 09 | Тел.: +359 2 489 46 10  
Имейл: [sales.bg@wago.com](mailto:sales.bg@wago.com)

Имате ли въпроси относно нашите продукти?  
Винаги ще се радваме да получим вашето обаждане на +359 2 489 46 09.



**Артикул №: 793-501/000-024**  
WMB marking card; as card; not stretchable; plain; snap-on type; violet

[www.wago.com/793-501/000-024](http://www.wago.com/793-501/000-024)



**Артикул №: 793-5501**  
WMB marking card; as card; for terminal block width 5 - 17.5 mm; stretchable 5 - 5.2 mm; plain; snap-on type; white

[www.wago.com/793-5501](http://www.wago.com/793-5501)



**Артикул №: 793-5501/000-002**  
WMB marking card; as card; for terminal block width 5 - 17.5 mm; stretchable 5 - 5.2 mm; plain; snap-on type; yellow

[www.wago.com/793-5501/000-002](http://www.wago.com/793-5501/000-002)



**Артикул №: 793-5501/000-005**  
WMB marking card; as card; for terminal block width 5 - 17.5 mm; stretchable 5 - 5.2 mm; plain; snap-on type; red

[www.wago.com/793-5501/000-005](http://www.wago.com/793-5501/000-005)



**Артикул №: 793-5501/000-006**  
WMB marking card; as card; for terminal block width 5 - 17.5 mm; stretchable 5 - 5.2 mm; plain; snap-on type; blue

[www.wago.com/793-5501/000-006](http://www.wago.com/793-5501/000-006)



**Артикул №: 793-5501/000-007**  
WMB marking card; as card; for terminal block width 5 - 17.5 mm; stretchable 5 - 5.2 mm; plain; snap-on type; gray

[www.wago.com/793-5501/000-007](http://www.wago.com/793-5501/000-007)



**Артикул №: 793-5501/000-012**  
WMB marking card; as card; for terminal block width 5 - 17.5 mm; stretchable 5 - 5.2 mm; plain; snap-on type; orange

[www.wago.com/793-5501/000-012](http://www.wago.com/793-5501/000-012)



**Артикул №: 793-5501/000-014**  
WMB marking card; as card; for terminal block width 5 - 17.5 mm; stretchable 5 - 5.2 mm; plain; snap-on type; brown

[www.wago.com/793-5501/000-014](http://www.wago.com/793-5501/000-014)



**Артикул №: 793-5501/000-017**  
WMB marking card; as card; for terminal block width 5 - 17.5 mm; stretchable 5 - 5.2 mm; plain; snap-on type; green

[www.wago.com/793-5501/000-017](http://www.wago.com/793-5501/000-017)



**Артикул №: 793-5501/000-023**  
WMB marking card; as card; for terminal block width 5 - 17.5 mm; stretchable 5 - 5.2 mm; plain; snap-on type; light green

[www.wago.com/793-5501/000-023](http://www.wago.com/793-5501/000-023)



**Артикул №: 793-5501/000-024**  
WMB marking card; as card; for terminal block width 5 - 17.5 mm; stretchable 5 - 5.2 mm; plain; snap-on type; violet

[www.wago.com/793-5501/000-024](http://www.wago.com/793-5501/000-024)

#### Protective Warning Marker



**Артикул №: 2004-115**  
Protective warning marker; with high-voltage symbol, black; for 5 terminal blocks; yellow

[www.wago.com/2004-115](http://www.wago.com/2004-115)

#### ferrule



**Артикул №: 216-262**  
Ferrule; Sleeve for 0.75 mm<sup>2</sup> / 18 AWG; insulated; electro-tin plated; electrolytic copper; gastight crimped; acc. to DIN 46228, Part 4/09.90; gray









[www.wago.com/216-262](http://www.wago.com/216-262)

**Артикул №: 216-263**

Подлежи на промяна. Моля, обърнете внимание и на допълнителната документация на продукта!

ВАГО България ООД  
Бизнес център Сердика  
Бул."Акад. Иван Гешов" 2Е | Сграда 1, ет. 4, офис 417 | 1330 София  
Тел.: +359 2 489 46 09 | Тел.: +359 2 489 46 10  
Имейл: [sales.bg@wago.com](mailto:sales.bg@wago.com)

Имате ли въпроси относно нашите продукти?  
Винаги ще се радваме да получим вашето обаждане на +359 2 489 46 09.

	Ferrule; Sleeve for 1 mm <sup>2</sup> / AWG 18; insulated; electro-tin plated; electrolytic copper; gastight crimped; acc. to DIN 46228, Part 4/09.90; red	<a href="http://www.wago.com/216-263">www.wago.com/216-263</a>
	<b>Артикул №: 216-264</b> Ferrule; Sleeve for 1.5 mm <sup>2</sup> / AWG 16; insulated; electro-tin plated; electrolytic copper; gastight crimped; acc. to DIN 46228, Part 4/09.90; black	<a href="http://www.wago.com/216-264">www.wago.com/216-264</a>
	<b>Артикул №: 216-266</b> Ferrule; Sleeve for 2.5 mm <sup>2</sup> / AWG 14; insulated; electro-tin plated; electrolytic copper; gastight crimped; acc. to DIN 46228, Part 4/09.90; blue	<a href="http://www.wago.com/216-266">www.wago.com/216-266</a>
	<b>Артикул №: 216-267</b> Ferrule; Sleeve for 4 mm <sup>2</sup> / AWG 12; insulated; electro-tin plated; electrolytic copper; gastight crimped; acc. to DIN 46228, Part 4/09.90; gray	<a href="http://www.wago.com/216-267">www.wago.com/216-267</a>
<b>End plate</b>		
	<b>Артикул №: 2004-1293</b> Separator plate; 2 mm thick; oversized; gray	<a href="http://www.wago.com/2004-1293">www.wago.com/2004-1293</a>
	<b>Артикул №: 2004-1294</b> Separator plate; 2 mm thick; oversized; orange	<a href="http://www.wago.com/2004-1294">www.wago.com/2004-1294</a>
	<b>Артикул №: 209-190</b> Separator for Ex e/Ex i applications; 3 mm thick; 90 mm wide; orange	<a href="http://www.wago.com/209-190">www.wago.com/209-190</a>
	<b>Артикул №: 209-191</b> Separator for Ex e/Ex i applications; 3 mm thick; 120 mm wide; orange	<a href="http://www.wago.com/209-191">www.wago.com/209-191</a>

**Изтегляния****Documentation****Bid Text**

2004-1204 X81 - Datei	Feb 19, 2019	xml 4,0 kB	Изтегляне
2004-1204 docx - Datei	Aug 7, 2018	docx 15,0 kB	Изтегляне

**Additional Information**

Technical explanations	Apr 3, 2019	pdf 2,2 MB	Изтегляне
------------------------	-------------	---------------	-----------

**CAD/CAE-Data****CAD data**

2D/3D Models 2004-1204	URL	Изтегляне
------------------------	-----	-----------

**CAE data**

Подлежи на промяна. Моля, обърнете внимание и на допълнителната документация на продукта!

ВАГО България ООД  
Бизнес център Сердика  
Бул."Акад. Иван Гешов" 2Е | Сграда 1, ет. 4, офис 417 | 1330 София  
Тел.: +359 2 489 46 09 | Тел.: +359 2 489 46 10  
Имейл: [sales.bg@wago.com](mailto:sales.bg@wago.com)

Имате ли въпроси относно нашите продукти?  
Винаги ще се радваме да получим вашето обаждане на +359 2 489 46 09.

EPLAN Data Portal 2004-1204	<a href="#">URL</a>	<a href="#">Изтегляне</a>
WSCAD Universe 2004-1204	<a href="#">URL</a>	<a href="#">Изтегляне</a>
ZUKEN Portal 2004-1204	<a href="#">URL</a>	<a href="#">Изтегляне</a>

## Бележки за инсталиране

### Conductor termination

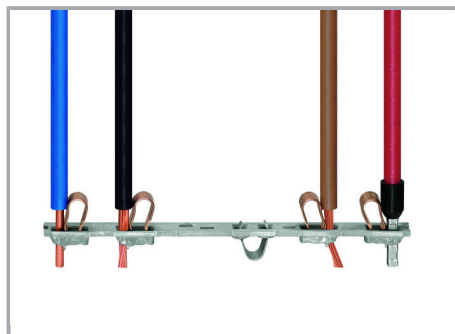

All conductor types at a glance

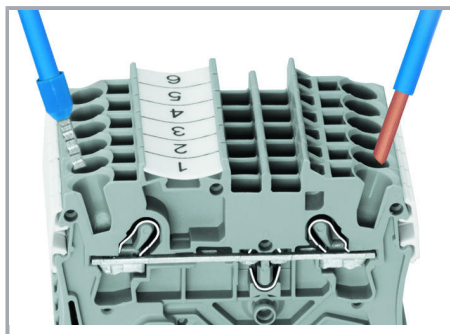

Terminating solid and ferruled conductors via push-in connection.

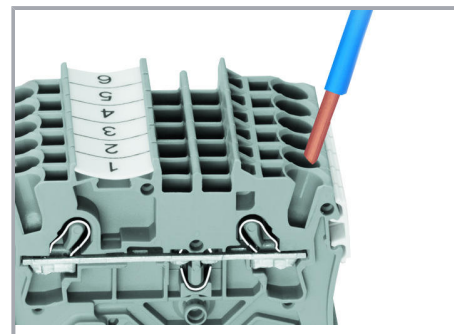

Inserting conductors via push-in termination.

**Solid conductors** with cross-sections from either one size above, or up to two sizes below, the rated cross-section can be simply pushed in – no tools needed.

Подлежи на промяна. Моля, обърнете внимание и на допълнителната документация на продукта!

ВАГО България ООД  
Бизнес център Сердика  
Бул."Акад. Иван Гешов" 2Е | Сграда 1, ет. 4, офис 417 | 1330 София  
Тел.: +359 2 489 46 09 | Тел.: +359 2 489 46 10  
Имейл: [sales.bg@wago.com](mailto:sales.bg@wago.com)

Имате ли въпроси относно нашите продукти?  
Винаги ще се радваме да получим вашето обаждане на +359 2 489 46 09.

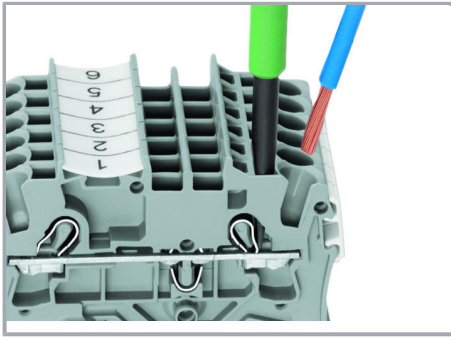

Inserting a conductor via operating tool.

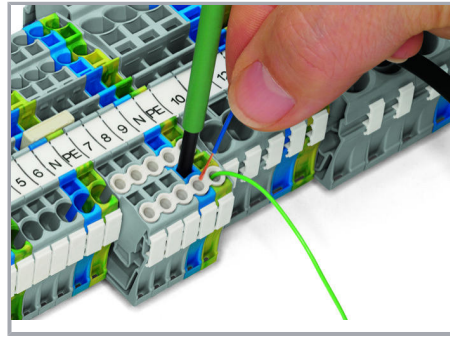

Conductor termination – Insulation stop.

Connecting fine-stranded conductors without ferrules, or small cross-sectional conductors that cannot be pushed in, is performed similarly to the original CAGE CLAMP® – just use an operating tool.

#### The smart feature:

To open the clamp, the operating tool is inserted vertically. The conductor entry is less than 15 degrees for easier wiring.

#### Commoning

Подлежи на промяна. Моля, обърнете внимание и на допълнителната документация на продукта!

ВАГО България ООД  
Бизнес център Сердика  
Бул."Акад. Иван Гешов" 2Е | Сграда 1, ет. 4, офис 417 | 1330 София  
Тел.: +359 2 489 46 09 | Тел.: +359 2 489 46 10  
Имейл: [sales.bg@wago.com](mailto:sales.bg@wago.com)

Имате ли въпроси относно нашите продукти?  
Винаги ще се радваме да получим вашето обаждане на +359 2 489 46 09.

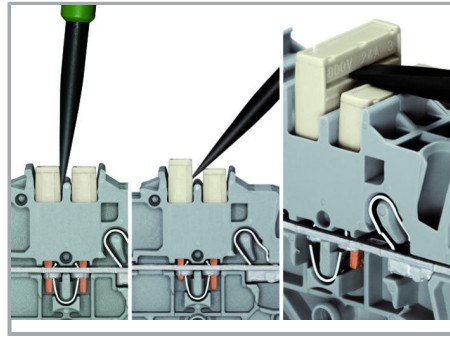
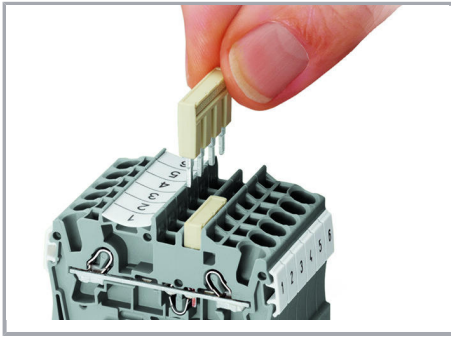

The push-in type jumper bar system is based on the common plug and socket principle. Each terminal block is spring-loaded with a double socket and a resilient CrNi steel spring. The jumper contact material is pure electrolytic copper, which allows for an extremely small design capable of carrying the full-rated current of the terminal block. Ground terminal blocks can also be commoned using the same jumper system. Custom jumpers are created by breaking and removing jumper contacts (2000, 2001, 2002, 2004 Series).

#### Removing a push-in type jumper bar.

Insert the operating tool between the jumper and and partition wall of the dual jumper slots, then lift up the jumper.

Place the operating tool in the center of jumpers up to five contacts (see above), or alternately on both sides for jumpers with more than five contacts.

#### Commoning

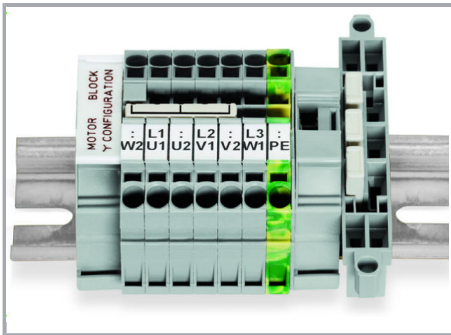

This star point jumper has been specially developed to create a "star point" and is used on motor terminal boards equipped with TOPJOB® S rail-mount terminal blocks.

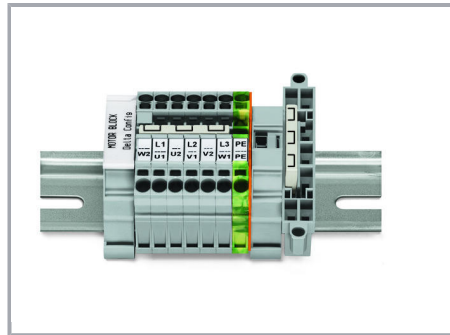

This delta jumper has been specially developed to create a delta configuration and is used on motor terminal boards equipped with TOPJOB® S rail-mount terminal blocks.

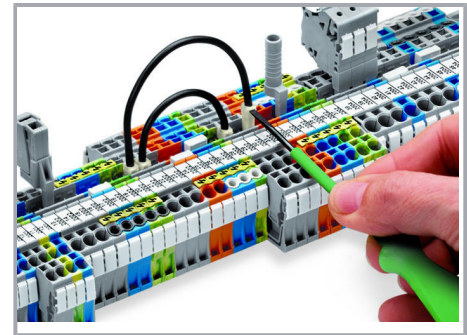

Push down the wire jumper until fully inserted. Lift the jumper with an operating tool for rewiring.

#### Commoning

Подлежи на промяна. Моля, обърнете внимание и на допълнителната документация на продукта!

ВАГО България ООД  
 Бизнес център Сердика  
 Бул."Акад. Иван Гешов" 2Е | Сграда 1, ет. 4, офис 417 | 1330 София  
 Тел.: +359 2 489 46 09 | Тел.: +359 2 489 46 10  
 Имейл: [sales.bg@wago.com](mailto:sales.bg@wago.com)

Имате ли въпроси относно нашите продукти?  
 Винаги ще се радваме да получим вашето обаждане на +359 2 489 46 09.

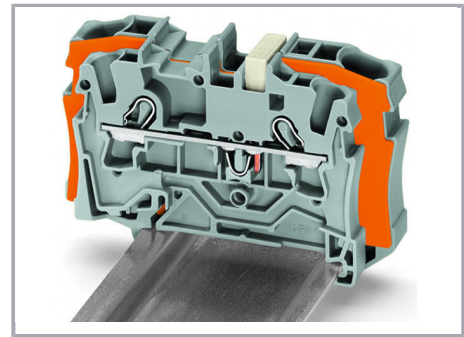
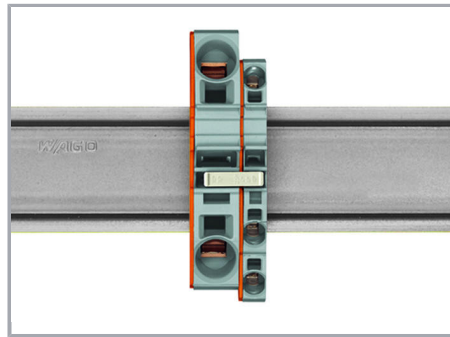
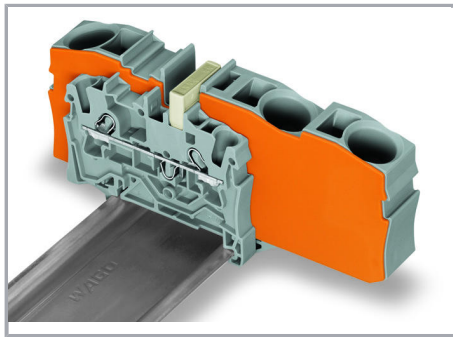

Step-down jumpers may common terminal blocks of different sizes, without losing a conductor clamping point. This can be beneficial on long conductor runs where voltage drops may be problematic. A large conductor can be easily connected to smaller conductors at the distribution point.

Using step-down jumpers, an end plate must be inserted between the terminal blocks to be commoned.

**Step-down jumper (2006-499)** commons 6 /4 mm<sup>2</sup> (10/12 AWG) terminal blocks (2006 /2004 Series) with 4/2.5/1.5 mm<sup>2</sup> (12/14/16 AWG) terminal blocks (2004/2002/2001 Series).

Commoning may be made in either direction using the special thin end plate to cover the open side. Additional through terminal blocks having a smaller cross-section may be commoned using push-in type jumper bars.

Подлежи на промяна. Моля, обърнете внимание и на допълнителната документация на продукта!

ВАГО България ООД  
Бизнес център Сердика  
Бул."Акад. Иван Гешов" 2Е | Сграда 1, ет. 4, офис 417 | 1330 София  
Тел.: +359 2 489 46 09 | Тел.: +359 2 489 46 10  
Имейл: [sales.bg@wago.com](mailto:sales.bg@wago.com)

Имате ли въпроси относно нашите продукти?  
Винаги ще се радваме да получим вашето обаждане на +359 2 489 46 09.

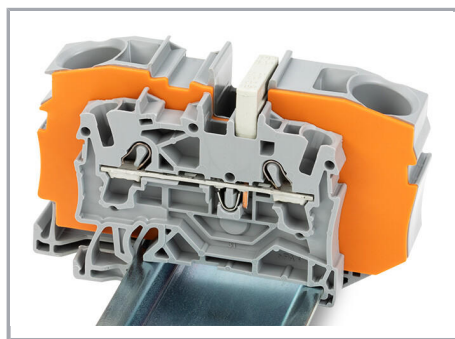

Step-down jumper (2016-499) commons 16 /10 mm<sup>2</sup> (16/8 AWG) terminal blocks (2016 /2010 Series) with 10/6/4/2.5 mm<sup>2</sup> (8/10/12 /14 AWG) terminal blocks (2010/2006/2004 /2002 Series).

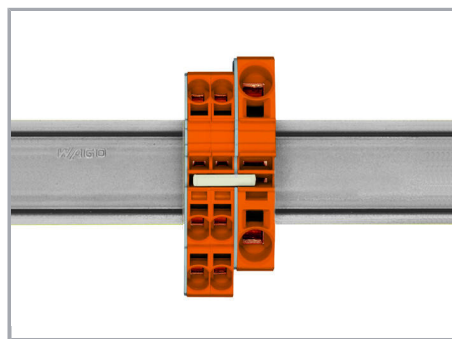

Stepping down via push-in type jumper bar.

Commoning via open terminal side with end plate allows jumpering over two cross-section sizes for 16 mm<sup>2</sup> (6 AWG) and 10 mm<sup>2</sup> (8 AWG) and one cross-section size for 6/4/2.5 mm<sup>2</sup> (10/12/14 AWG). An example: from 16 mm<sup>2</sup> (6 AWG) to 6 mm<sup>2</sup> (10 AWG) (see illustration above) or from 10 mm<sup>2</sup> (8 AWG) to 4 mm<sup>2</sup> (12 AWG).

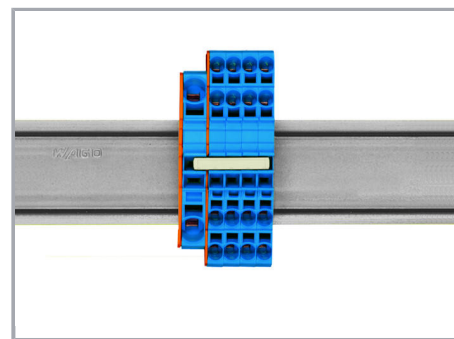

Stepping down via push-in type jumper bar.

Commoning via closed terminal side with end plate allows jumpering over two cross-section sizes, e.g., from 16 mm<sup>2</sup> (6 AWG) to 6 mm<sup>2</sup> (10 AWG) or from 6 mm<sup>2</sup> (10 AWG) to 2.5 mm<sup>2</sup> (14 AWG) (see illustration above).

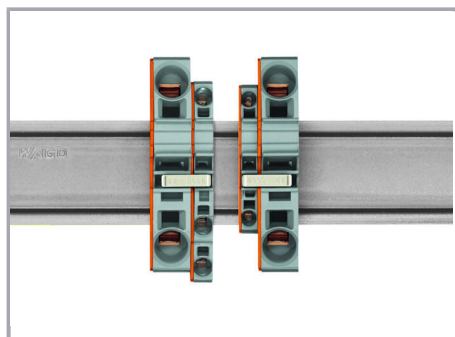

**Note:**

The total current of the outgoing circuits shall not exceed the nominal current of the step-down jumper/push-in type jumper bar.

**Testing**

Подлежи на промяна. Моля, обърнете внимание и на допълнителната документация на продукта!

ВАГО България ООД  
 Бизнес център Сердика  
 Бул."Акад. Иван Гешов" 2Е | Сграда 1, ет. 4, офис 417 | 1330 София  
 Тел.: +359 2 489 46 09 | Тел.: +359 2 489 46 10  
 Имейл: [sales.bg@wago.com](mailto:sales.bg@wago.com)

Имате ли въпроси относно нашите продукти?  
 Винаги ще се радваме да получим вашето обаждане на +359 2 489 46 09.

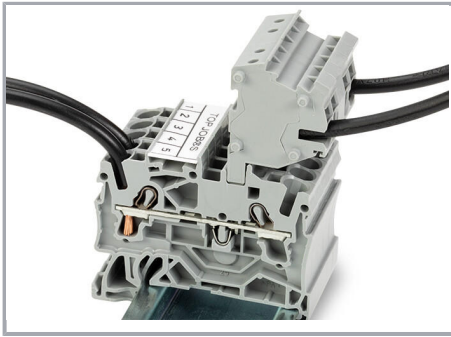

The modular TOPJOB® S connectors also connect conductors of the same size as the terminal blocks being used.

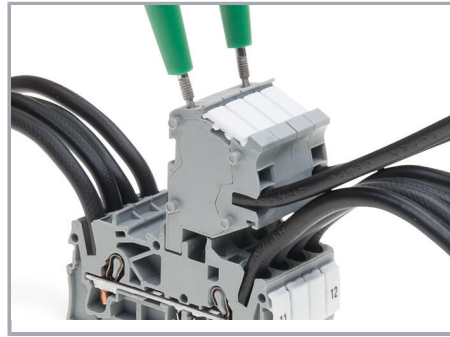

TOPJOB® S Connectors with a 2 mm Ø test socket for testing voltage via 2-pole voltage tester

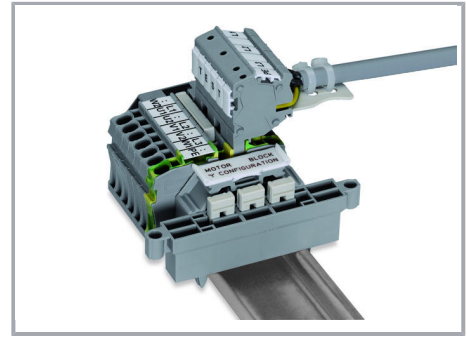

Rail-mount terminal block assembly for electric motor wiring

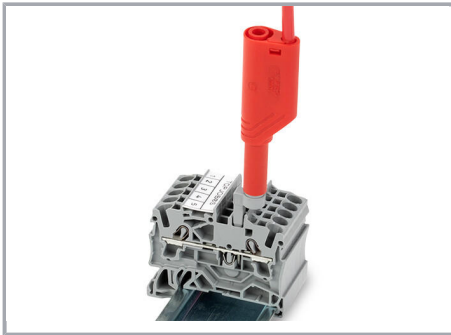

Test plug adapter (2009-174, CAT I) for 4 mm Ø plugs – compatible with 2000 to 2016 Series

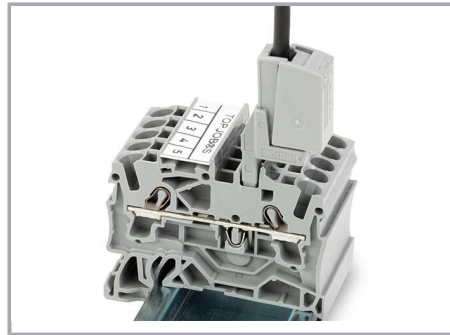

Testing tap (2009-182) for tool-free connection of test cables up to 2.5 mm<sup>2</sup> (12 AWG) – compatible with 2000 to 2016 Series

### Marking

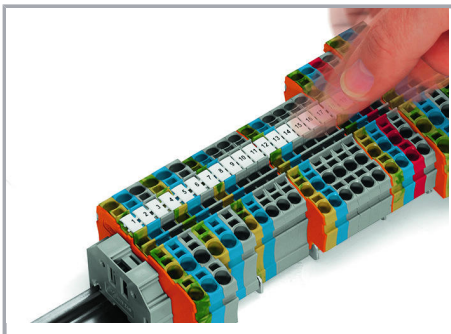

Snapping WMB Inline markers into marker slots.

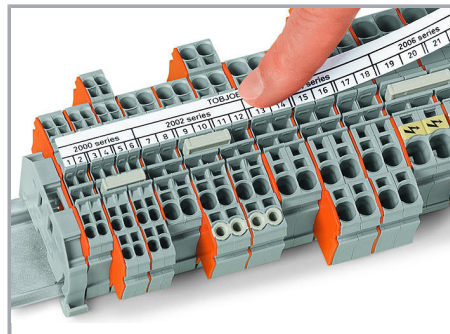

Подлежи на промяна. Моля, обърнете внимание и на допълнителната документация на продукта!

ВАГО България ООД  
Бизнес център Сердика  
Бул."Акад. Иван Гешов" 2Е | Сграда 1, ет. 4, офис 417 | 1330 София  
Тел.: +359 2 489 46 09 | Тел.: +359 2 489 46 10  
Имейл: [sales.bg@wago.com](mailto:sales.bg@wago.com)

Имате ли въпроси относно нашите продукти?  
Винаги ще се радваме да получим вашето обаждане на +359 2 489 46 09.

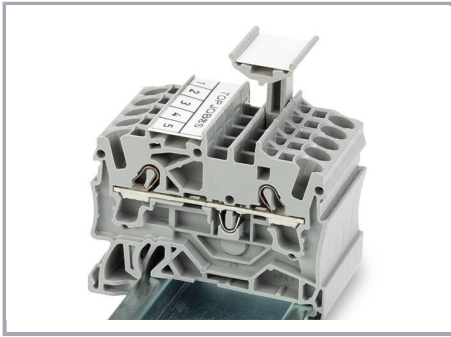

TOPJOB® S 2009-193 Group Marker Carrier (equipped with a marking strip) for all 2001 to 2016 Series TOPJOB® S Rail-Mount Terminal Blocks

Do not use on an end plate!

#### Ex application

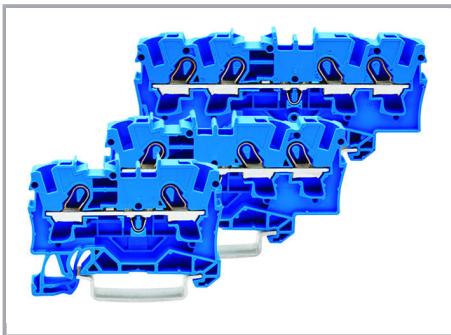

Through terminal blocks with a blue insulated housing are suitable for Ex i applications.



All through and ground conductor terminal blocks are suitable for Ex e II applications.

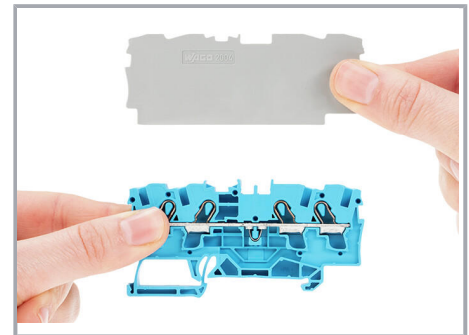

Separator for Ex e/Ex applications

An end plate must be applied to the terminal block located directly behind an Ex e/Ex i separator plate.

Подлежи на промяна. Моля, обърнете внимание и на допълнителната документация на продукта!

ВАГО България ООД  
Бизнес център Сердика  
Бул."Акад. Иван Гешов" 2Е | Сграда 1, ет. 4, офис 417 | 1330 София  
Тел.: +359 2 489 46 09 | Тел.: +359 2 489 46 10  
Имейл: [sales.bg@wago.com](mailto:sales.bg@wago.com)

Имате ли въпроси относно нашите продукти?  
Винаги ще се радваме да получим вашето обаждане на +359 2 489 46 09.

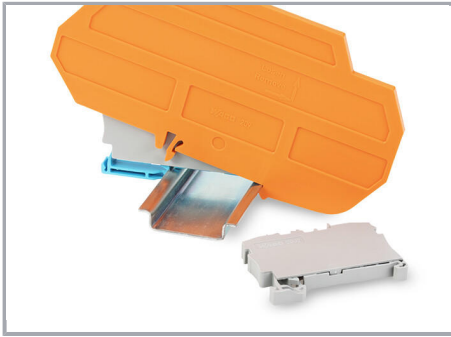

Ex e II/Ex i terminal strip

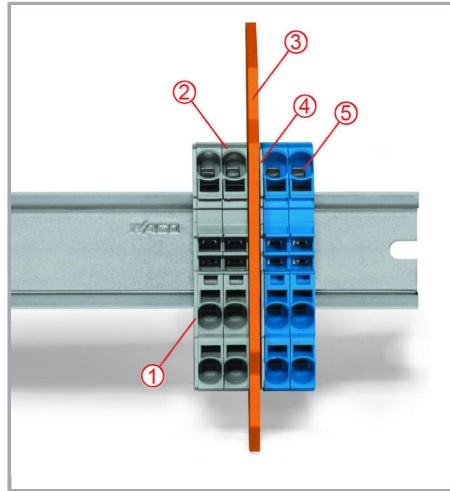

**Notice:**

The movable feet of terminal blocks and separator plates must face the same direction.

Separator located between Ex e II and Ex i terminal strip

End plate

Ex e II terminal blocks

Separator for Ex e/Ex i applications

End plate

Ex i terminal blocks

According to EN 50020, a minimum distance of 50 mm must be kept between live parts of Ex e and Ex i circuits. The use of Ex e/Ex i separators is a space-saving solution when Ex e and Ex i terminal blocks are mounted on a common carrier rail.

**Семейство продукти**

**TOPJOB® S**

Подлежи на промяна. Моля, обърнете внимание и на допълнителната документация на продукта!

ВАГО България ООД  
Бизнес център Сердика  
Бул."Акад. Иван Гешов" 2Е | Сграда 1, ет. 4, офис 417 | 1330 София  
Тел.: +359 2 489 46 09 | Тел.: +359 2 489 46 10  
Имейл: [sales.bg@wago.com](mailto:sales.bg@wago.com)

Имате ли въпроси относно нашите продукти?  
Винаги ще се радваме да получим вашето обаждане на +359 2 489 46 09.



TOPJOB® S: In various industrial applications and modern building installations, WAGO's wide and versatile range of rail-mount terminal blocks provides more than just reliable electrical connections.

Показване на всички продукти от семейството.

Подлежи на промяна. Моля, обърнете внимание и на допълнителната документация на продукта!

ВАГО България ООД  
Бизнес център Сердика  
Бул."Акад. Иван Гешов" 2Е | Сграда 1, ет. 4, офис 417 | 1330 София  
Тел.: +359 2 489 46 09 | Тел.: +359 2 489 46 10  
Имейл: [sales.bg@wago.com](mailto:sales.bg@wago.com)

Имате ли въпроси относно нашите продукти?  
Винаги ще се радваме да получим вашето обаждане на +359 2 489 46 09.