

Информационен лист | Номер на артикул: 2002-1207

2-conductor ground terminal block; 2.5 mm²; suitable for Ex e II applications; side and center marking; for DIN-rail 35 x 15 and 35 x 7.5; Push-in CAGE CLAMP®; 2,50 mm²; green-yellow

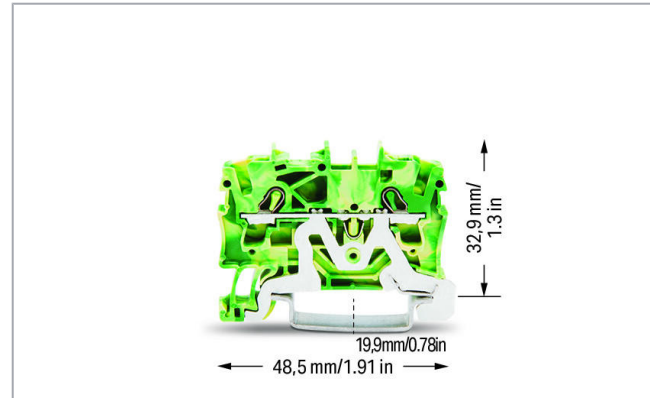

www.wago.com/2002-1207

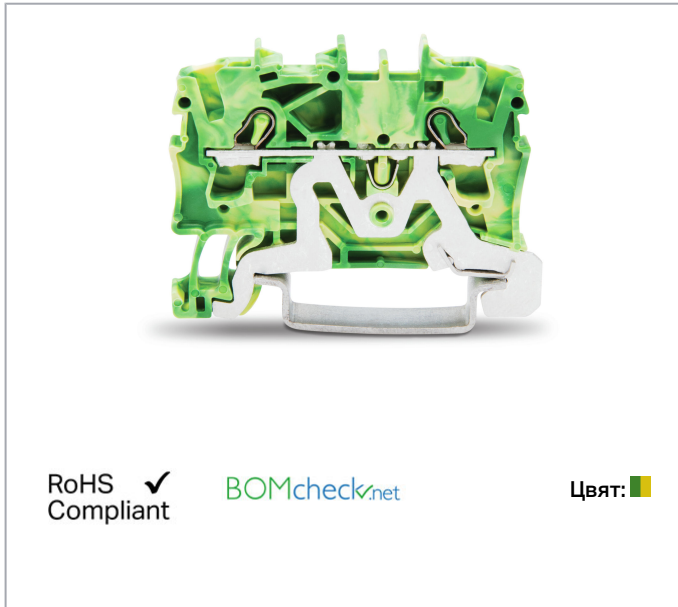

RoHS Compliant

[BOMcheck.net](https://www.bomcheck.net)

Цвят:

Данни

Electrical data

Ratings per IEC/EN 60664-1

Ratings per

IEC/EN 60947-7-2

Connection data

Connection technology	Push-in CAGE CLAMP®
Actuation type	Push-in Operating tool
Connectable conductor materials	Copper
Nominal cross-section	2,5 mm ²
Solid conductor	0,25 ... 4 mm ² / 22 ... 12 AWG
Solid conductor; push-in termination	0,75 ... 4 mm ² / 18 ... 12 AWG
Fine-stranded conductor	0,25 ... 4 mm ² / 22 ... 12 AWG
Fine-stranded conductor; with insulated ferrule	1 ... 2,5 mm ² / 18 ... 14 AWG
Fine-stranded conductor; with ferrule; push-in termination	1 ... 2,5 mm ² / 18 ... 14 AWG

Подлежи на промяна. Моля, обърнете внимание и на допълнителната документация на продукта!

ВАГО България ООД
Бизнес център Сердика
Бул."Акад. Иван Гешов" 2Е | Сграда 1, ет. 4, офис 417 | 1330 София
Тел.: +359 2 489 46 09 | Тел.: +359 2 489 46 10
Имейл: sales.bg@wago.com

Имате ли въпроси относно нашите продукти?
Винаги ще се радваме да получим вашето обаждане на +359 2 489 46 09.



Note (conductor cross-section)	Depending on the conductor characteristic, a conductor with a smaller cross-section can also be inserted via push-in termination.
Strip length	10 ... 12 mm / 0.39 ... 0.47 inch
Total number of connection points	2
Total number of potentials	1
Number of levels	1
Wiring type	Front-entry wiring
Number of jumper slots	2

Physical data

Width	5,2 mm / 0.205 inch
Height from upper-edge of DIN-rail	32,9 mm / 1.295 inch
Depth	50,8 mm / 2 inch

Mechanical data

Design	horizontal type
Mounting type	DIN-35 rail
Marking level	Center/side marking

Material Data

Color	green-yellow
Insulation material	Polyamide (PA66)
Fire load	0,087 MJ
Weight	7,7 g

Commercial data

Product Group	22 (TOPJOB S)
Packaging type	BOX
Country of origin	DE
GTIN	4017332999212
Customs tariff number	85369010000

Одобрения / Сертификати

Ex-Approvals

Лого	Одобрение	Допълнителен текст за одобрение	Име на сертификат
	AEx Underwriters Laboratories Inc.	UL 60079	20190704-E185892



Подлежи на промяна. Моля, обърнете внимание и на допълнителната документация на продукта!

ВАГО България ООД
 Бизнес център Сердика
 Бул."Акад. Иван Гешов" 2Е | Сграда 1, ет. 4, офис 417 | 1330 София
 Тел.: +359 2 489 46 09 | Тел.: +359 2 489 46 10
 Имейл: sales.bg@wago.com

Имате ли въпроси относно нашите продукти?
 Винаги ще се радваме да получим вашето обаждане на +359 2 489 46 09.

AEx ell

Ex ell

	ATEX Physikalisch Technische Bundesanstalt (PTB)	EN 60079	PTB 03 ATEX 1162 U (II 2 G/D Ex e II bzw. I M 2 Ex e I)
	CCCEX CQST/CNEX	CNCA-C23-01	2020312313000238
	IECEX Physikalisch Technische Bundesanstalt	IEC 60079	IECEX PTB 03.0004 U (Ex eb IIC Gb or Ex eb I Mb)

Country specific Approvals

Лого	Одобрение	Допълнителен текст за одобрение	Име на сертификат
	CCA DEKRA Certification B.V.	EN 60947	NTR NL 7730
	CSA DEKRA Certification B.V.	C22.2 No. 158	1536069
	EAC Brjansker Zertifizierungsstelle	TP TC 012/2011	RU C-DE. AM02.B. 00127/19
	KEMA/KEUR DEKRA Certification B.V.	EN 60947	71-107687

Ship Approvals

Лого	Одобрение	Допълнителен текст за одобрение	Име на сертификат
	ABS American Bureau of Shipping	EN 60947	20- HG1941090- PDA

Подлежи на промяна. Моля, обърнете внимание и на допълнителната документация на продукта!

ВАГО България ООД
Бизнес център Сердика
Бул."Акад. Иван Гешов" 2Е | Сграда 1, ет. 4, офис 417 | 1330 София
Тел.: +359 2 489 46 09 | Тел.: +359 2 489 46 10
Имейл: sales.bg@wago.com

Имате ли въпроси относно нашите продукти?
Винаги ще се радваме да получим вашето обаждане на +359 2 489 46 09.



	BV Bureau Veritas S.A.	EN 60947	38586/A0 BV
	DNV GL Det Norske Veritas, Germanischer Lloyd	-	TAE00001V2
	LR Lloyds Register	EN 60947	91/20112 (E9)

UL-Approvals

Лого	Одобрение	Допълнителен текст за одобрение	Име на сертификат
	cURus Underwriters Laboratories Inc.	UL 1059	20190731- E45172

Изискват се аксесоари

End plate



	Артикул №: 2002-1291 End and intermediate plate; 0.8 mm thick; gray	www.wago.com/2002-1291
	Артикул №: 2002-1292 End and intermediate plate; 0.8 mm thick; orange	www.wago.com/2002-1292

Съвместими продукти

Protective Warning Marker

	Артикул №: 2002-115 Protective warning marker; with high-voltage symbol, black; for 5 terminal blocks; yellow	www.wago.com/2002-115
--	---	--

Jumper

	Артикул №: 2002-400 Continuous jumper; 2-way; insulated; light gray	www.wago.com/2002-400
	Артикул №: 2002-402 Jumper; 2-way; insulated; light gray	www.wago.com/2002-402
	Артикул №: 2002-402/000-005 Jumper; 2-way; insulated; red	www.wago.com/2002-402/000-005

Подлежи на промяна. Моля, обърнете внимание и на допълнителната документация на продукта!

ВАГО България ООД
Бизнес център Сердика
Бул."Акад. Иван Гешов" 2Е | Сграда 1, ет. 4, офис 417 | 1330 София
Тел.: +359 2 489 46 09 | Тел.: +359 2 489 46 10
Имейл: sales.bg@wago.com















Имате ли въпроси относно нашите продукти?
Винаги ще се радваме да получим вашето обаждане на +359 2 489 46 09.

	Артикул №: 2002-402/000-006 Jumper; 2-way; insulated; blue	www.wago.com/2002-402/000-006
	Артикул №: 2002-403 Jumper; 3-way; insulated; light gray	www.wago.com/2002-403
	Артикул №: 2002-403/000-005 Jumper; 3-way; insulated; red	www.wago.com/2002-403/000-005
	Артикул №: 2002-403/000-006 Jumper; 3-way; insulated; blue	www.wago.com/2002-403/000-006
	Артикул №: 2002-404 Jumper; 4-way; insulated; light gray	www.wago.com/2002-404
	Артикул №: 2002-404/000-005 Jumper; 4-way; insulated; red	www.wago.com/2002-404/000-005
	Артикул №: 2002-404/000-006 Jumper; 4-way; insulated; blue	www.wago.com/2002-404/000-006
	Артикул №: 2002-405 Jumper; 5-way; insulated; light gray	www.wago.com/2002-405
	Артикул №: 2002-405/000-005 Jumper; 5-way; insulated; red	www.wago.com/2002-405/000-005
	Артикул №: 2002-405/000-006 Jumper; 5-way; insulated; blue	www.wago.com/2002-405/000-006
	Артикул №: 2002-405/011-000 Star point jumper; 3-way; insulated; light gray	www.wago.com/2002-405/011-000
	Артикул №: 2002-406 Jumper; 6-way; insulated; light gray	www.wago.com/2002-406
	Артикул №: 2002-406/000-005 Jumper; 6-way; insulated; red	www.wago.com/2002-406/000-005
	Артикул №: 2002-406/000-006 Jumper; 6-way; insulated; blue	www.wago.com/2002-406/000-006















Подлежи на промяна. Моля, обърнете внимание и на допълнителната документация на продукта!

ВАГО България ООД
Бизнес център Сердика
Бул."Акад. Иван Гешов" 2Е | Сграда 1, ет. 4, офис 417 | 1330 София
Тел.: +359 2 489 46 09 | Тел.: +359 2 489 46 10
Имейл: sales.bg@wago.com

Имате ли въпроси относно нашите продукти?
Винаги ще се радваме да получим вашето обаждане на +359 2 489 46 09.

	Артикул №: 2002-406/020-000 Delta jumper; insulated; light gray	www.wago.com/2002-406/020-000
	Артикул №: 2002-407 Jumper; 7-way; insulated; light gray	www.wago.com/2002-407
	Артикул №: 2002-407/000-005 Jumper; 7-way; insulated; red	www.wago.com/2002-407/000-005
	Артикул №: 2002-407/000-006 Jumper; 7-way; insulated; blue	www.wago.com/2002-407/000-006
	Артикул №: 2002-408 Jumper; 8-way; insulated; light gray	www.wago.com/2002-408
	Артикул №: 2002-408/000-005 Jumper; 8-way; insulated; red	www.wago.com/2002-408/000-005
	Артикул №: 2002-408/000-006 Jumper; 8-way; insulated; blue	www.wago.com/2002-408/000-006
	Артикул №: 2002-409 Jumper; 9-way; insulated; light gray	www.wago.com/2002-409
	Артикул №: 2002-409/000-005 Jumper; 9-way; insulated; red	www.wago.com/2002-409/000-005
	Артикул №: 2002-409/000-006 Jumper; 9-way; insulated; blue	www.wago.com/2002-409/000-006
	Артикул №: 2002-410 Jumper; 10-way; insulated; light gray	www.wago.com/2002-410
	Артикул №: 2002-410/000-005 Jumper; 10-way; insulated; red	www.wago.com/2002-410/000-005
	Артикул №: 2002-410/000-006 Jumper; 10-way; insulated; blue	www.wago.com/2002-410/000-006
	Артикул №: 2002-423 Continuous jumper; from 1 to 3; insulated; light gray	www.wago.com/2002-423
	Артикул №: 2002-423/000-005 Continuous jumper; from 1 to 3; insulated; red	www.wago.com/2002-423/000-005

Подлежи на промяна. Моля, обърнете внимание и на допълнителната документация на продукта!

	Артикул №: 2002-423/000-006 Continuous jumper; from 1 to 3; insulated; blue	www.wago.com/2002-423/000-006
	Артикул №: 2002-433 Jumper; from 1 to 3; insulated; light gray	www.wago.com/2002-433
	Артикул №: 2002-434 Jumper; from 1 to 4; insulated; light gray	www.wago.com/2002-434
	Артикул №: 2002-435 Jumper; from 1 to 5; insulated; light gray	www.wago.com/2002-435
	Артикул №: 2002-436 Jumper; from 1 to 6; insulated; light gray	www.wago.com/2002-436
	Артикул №: 2002-437 Jumper; from 1 to 7; insulated; light gray	www.wago.com/2002-437
	Артикул №: 2002-438 Jumper; from 1 to 8; insulated; light gray	www.wago.com/2002-438
	Артикул №: 2002-439 Jumper; from 1 to 9; insulated; light gray	www.wago.com/2002-439
	Артикул №: 2002-440 Jumper; from 1 to 10; insulated; light gray	www.wago.com/2002-440
	Артикул №: 2002-472 Staggered jumper; 2-way; insulated; light gray	www.wago.com/2002-472
	Артикул №: 2002-473 Staggered jumper; 3-way; insulated; light gray	www.wago.com/2002-473
	Артикул №: 2002-473/011-000 Staggered jumper; 2-way; from 1 to 3; insulated; light gray	www.wago.com/2002-473/011-000
	Артикул №: 2002-474 Staggered jumper; 4-way; insulated; light gray	www.wago.com/2002-474
	Артикул №: 2002-475 Staggered jumper; 5-way; insulated; light gray	www.wago.com/2002-475
	Артикул №: 2002-475/011-000 Staggered jumper; 3-way; insulated; light gray	www.wago.com/2002-475/011-000
	Артикул №: 2002-476 Staggered jumper; 6-way; insulated; light gray	www.wago.com/2002-476
	Артикул №: 2002-477 Staggered jumper; 7-way; insulated; light gray	www.wago.com/2002-477

Подлежи на промяна. Моля, обърнете внимание и на допълнителната документация на продукта!

ВАГО България ООД
Бизнес център Сердика
Бул."Акад. Иван Гешов" 2Е | Сграда 1, ет. 4, офис 417 | 1330 София
Тел.: +359 2 489 46 09 | Тел.: +359 2 489 46 10
Имейл: sales.bg@wago.com

Имате ли въпроси относно нашите продукти?
Винаги ще се радваме да получим вашето обаждане на +359 2 489 46 09.



Артикул №: 2002-477/011-000
Staggered jumper; insulated; light gray

www.wago.com/2002-477/011-000



Артикул №: 2002-478
Staggered jumper; 8-way; insulated; light gray

www.wago.com/2002-478



Артикул №: 2002-479
Staggered jumper; 9-way; insulated; light gray

www.wago.com/2002-479

Артикул №: 2002-479/011-000
Staggered jumper; insulated; light gray

www.wago.com/2002-479/011-000



Артикул №: 2002-480
Staggered jumper; 10-way; insulated; light gray

www.wago.com/2002-480



Артикул №: 2002-481
Staggered jumper; 11-way; insulated; light gray

www.wago.com/2002-481

Артикул №: 2002-481/011-000
Staggered jumper; insulated; light gray

www.wago.com/2002-481/011-000



Артикул №: 2002-482
Staggered jumper; 12-way; insulated; light gray

www.wago.com/2002-482



Артикул №: 210-103
Wire commoning chain; insulated; black

www.wago.com/210-103

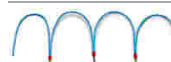

Артикул №: 210-123
Wire commoning chain; insulated; blue

www.wago.com/210-123

End plate



Артикул №: 2002-1293
Separator plate; 2 mm thick; oversized; gray

www.wago.com/2002-1293



Артикул №: 2002-1294
Separator plate; 2 mm thick; oversized; orange

www.wago.com/2002-1294



Артикул №: 209-190
Separator for Ex e/Ex i applications; 3 mm thick; 90 mm wide; orange

www.wago.com/209-190



Артикул №: 209-191
Separator for Ex e/Ex i applications; 3 mm thick; 120 mm wide; orange

www.wago.com/209-191

check



Артикул №: 2002-511
Modular TOPJOB®S connector; modular; for jumper contact slot; 1-pole; 2,50 mm²; gray

















www.wago.com/2002-511



Артикул №: 2002-549
Spacer module; modular; e.g., for bridging commoned terminal blocks; gray

www.wago.com/2002-549

Подлежи на промяна. Моля, обърнете внимание и на допълнителната документация на продукта!

	Артикул №: 2002-552 Modular TOPJOB®S connector; modular; for jumper contact slot; 2-pole; 2,50 mm ² ; gray	www.wago.com/2002-552
	Артикул №: 2002-553 Modular TOPJOB®S connector; modular; for jumper contact slot; 3-pole; 2,50 mm ² ; gray	www.wago.com/2002-553
	Артикул №: 2002-554 Modular TOPJOB®S connector; modular; for jumper contact slot; 4-pole; 2,50 mm ² ; gray	www.wago.com/2002-554
	Артикул №: 2002-555 Modular TOPJOB®S connector; modular; for jumper contact slot; 5-pole; 2,50 mm ² ; gray	www.wago.com/2002-555
	Артикул №: 2002-556 Modular TOPJOB®S connector; modular; for jumper contact slot; 6-pole; 2,50 mm ² ; gray	www.wago.com/2002-556
	Артикул №: 2002-557 Modular TOPJOB®S connector; modular; for jumper contact slot; 7-pole; 2,50 mm ² ; gray	www.wago.com/2002-557
	Артикул №: 2002-558 Modular TOPJOB®S connector; modular; for jumper contact slot; 8-pole; 2,50 mm ² ; gray	www.wago.com/2002-558
	Артикул №: 2002-559 Modular TOPJOB®S connector; modular; for jumper contact slot; 9-pole; 2,50 mm ² ; gray	www.wago.com/2002-559
	Артикул №: 2002-560 Modular TOPJOB®S connector; modular; for jumper contact slot; 10-pole; 2,50 mm ² ; gray	www.wago.com/2002-560
	Артикул №: 2002-611 TOPJOB®S L-type test plug module; modular; 1-pole; 2,50 mm ² ; gray	www.wago.com/2002-611
	Артикул №: 2002-649 TOPJOB®S L-type spacer module; modular; e.g., for bridging commoned terminal blocks; gray	www.wago.com/2002-649
	Артикул №: 2009-174 Test plug adapter; for 4 mm Ø test plugs; for testing TOPJOB®S rail-mounted terminal blocks; gray	www.wago.com/2009-174
	Артикул №: 2009-182 Testing tap; for max. 2.5 mm ² ; tool-free connection for individual test wires 0.08 - 2.5 mm; gray	www.wago.com/2009-182
ferrule		
	Артикул №: 216-241 Ferrule; Sleeve for 0.5 mm ² / 20 AWG; insulated; electro-tin plated; electrolytic copper; gastight crimped; acc. to DIN 46228, Part 4/09.90; white	www.wago.com/216-241
	Артикул №: 216-242 Ferrule; Sleeve for 0.75 mm ² / 18 AWG; insulated; electro-tin plated; electrolytic copper; gastight crimped; acc. to DIN 46228, Part 4/09.90; gray	www.wago.com/216-242
	Артикул №: 216-243 Ferrule; Sleeve for 1 mm ² / AWG 18; insulated; electro-tin plated; electrolytic copper; gastight crimped; acc. to DIN 46228, Part 4/09.90; red	www.wago.com/216-243
	Артикул №: 216-244 Ferrule; Sleeve for 1.5 mm ² / AWG 16; insulated; electro-tin plated; electrolytic copper; gastight crimped; acc. to DIN 46228, Part 4/09.90; black	www.wago.com/216-244
	Артикул №: 216-246	

Подлежи на промяна. Моля, обърнете внимание и на допълнителната документация на продукта!

ВАГО България ООД
Бизнес център Сердика
Бул."Акад. Иван Гешов" 2Е | Сграда 1, ет. 4, офис 417 | 1330 София
Тел.: +359 2 489 46 09 | Тел.: +359 2 489 46 10
Имейл: sales.bg@wago.com















Имате ли въпроси относно нашите продукти?
Винаги ще се радваме да получим вашето обаждане на +359 2 489 46 09.

	Ferrule; Sleeve for 2.5 mm ² / AWG 14; insulated; electro-tin plated; electrolytic copper; gastight crimped; acc. to DIN 46228, Part 4/09.90; blue	www.wago.com/216-246
	Артикул №: 216-262 Ferrule; Sleeve for 0.75 mm ² / 18 AWG; insulated; electro-tin plated; electrolytic copper; gastight crimped; acc. to DIN 46228, Part 4/09.90; gray	www.wago.com/216-262
	Артикул №: 216-263 Ferrule; Sleeve for 1 mm ² / AWG 18; insulated; electro-tin plated; electrolytic copper; gastight crimped; acc. to DIN 46228, Part 4/09.90; red	www.wago.com/216-263
	Артикул №: 216-264 Ferrule; Sleeve for 1.5 mm ² / AWG 16; insulated; electro-tin plated; electrolytic copper; gastight crimped; acc. to DIN 46228, Part 4/09.90; black	www.wago.com/216-264
	Артикул №: 216-266 Ferrule; Sleeve for 2.5 mm ² / AWG 14; insulated; electro-tin plated; electrolytic copper; gastight crimped; acc. to DIN 46228, Part 4/09.90; blue	www.wago.com/216-266
Insulation stop		
	Артикул №: 2002-171 Insulation stop; 0.25 - 0.5 mm ² ; 5 pieces/strip; light gray	www.wago.com/2002-171
	Артикул №: 2002-172 Insulation stop; 0.75 - 1 mm ² ; 5 pieces/strip; dark gray	www.wago.com/2002-172
Push-In type wire jumper		
	Артикул №: 2009-412 Push-in type wire jumper; insulated; 60 mm long; black	www.wago.com/2009-412
	Артикул №: 2009-414 Push-in type wire jumper; 1.5 mm ² ; insulated; 110 mm long; black	www.wago.com/2009-414
	Артикул №: 2009-414/000-005 Push-in type wire jumper; 1.5 mm ² ; insulated; 110 mm long; black	www.wago.com/2009-414/000-005
	Артикул №: 2009-414/000-006 Push-in type wire jumper; insulated; 110 mm long; black	www.wago.com/2009-414/000-006
	Артикул №: 2009-416 Push-in type wire jumper; 1.5 mm ² ; insulated; 250 mm long; black	www.wago.com/2009-416
tools		
	Артикул №: 210-658 Operating tool; Blade: 3.5 x 0.5 mm; with a partially insulated shaft; angled; short; multicoloured	www.wago.com/210-658
	Артикул №: 210-720 Operating tool; Blade: 3.5 x 0.5 mm; with a partially insulated shaft; multicoloured	www.wago.com/210-720
Carrier rail		
	Артикул №: 210-112 Steel carrier rail; 35 x 7.5 mm; 1 mm thick; 2 m long; slotted; according to EN 60715; "Hole width 25 mm; silver-colored	www.wago.com/210-112















Подлежи на промяна. Моля, обърнете внимание и на допълнителната документация на продукта!

ВАГО България ООД
Бизнес център Сердика
Бул."Акад. Иван Гешов" 2Е | Сграда 1, ет. 4, офис 417 | 1330 София
Тел.: +359 2 489 46 09 | Тел.: +359 2 489 46 10
Имейл: sales.bg@wago.com

Имате ли въпроси относно нашите продукти?
Винаги ще се радваме да получим вашето обаждане на +359 2 489 46 09.

	Артикул №: 210-113 Steel carrier rail; 35 x 7.5 mm; 1 mm thick; 2 m long; unslotted; according to EN 60715; silver-colored	www.wago.com/210-113
	Артикул №: 210-114 Steel carrier rail; 35 x 15 mm; 1.5 mm thick; 2 m long; unslotted; similar to EN 60715; silver-colored	www.wago.com/210-114
	Артикул №: 210-115 Steel carrier rail; 35 x 7.5 mm; 1 mm thick; 2 m long; slotted; according to EN 60715; "Hole width 18 mm; silver-colored	www.wago.com/210-115
	Артикул №: 210-118 Steel carrier rail; 35 x 15 mm; 2.3 mm thick; 2 m long; unslotted; according to EN 60715; silver-colored	www.wago.com/210-118
	Артикул №: 210-196 Aluminum carrier rail; 35 x 8.2 mm; 1.6 mm thick; 2 m long; unslotted; similar to EN 60715; silver-colored	www.wago.com/210-196
	Артикул №: 210-197 Steel carrier rail; 35 x 15 mm; 1.5 mm thick; 2 m long; slotted; similar to EN 60715; silver-colored	www.wago.com/210-197
	Артикул №: 210-198 Copper carrier rail; 35 x 15 mm; 2.3 mm thick; 2 m long; unslotted; according to EN 60715; copper-colored	www.wago.com/210-198
	Артикул №: 210-504 Steel carrier rail; 35 x 7.5 mm; 1 mm thick; 2 m long; slotted; galvanized; according to EN 60715	www.wago.com/210-504
	Артикул №: 210-505 Steel carrier rail; 35 x 7.5 mm; 1 mm thick; 2 m long; unslotted; galvanized; according to EN 60715; silver-colored	www.wago.com/210-505
	Артикул №: 210-506 Steel carrier rail; 35 x 15 mm; 1.5 mm thick; 2 m long; unslotted; galvanized; similar to EN 60715; silver-colored	www.wago.com/210-506
	Артикул №: 210-508 Steel carrier rail; 35 x 15 mm; 1.5 mm thick; 2 m long; slotted; galvanized; similar to EN 60715; silver-colored	www.wago.com/210-508
Marking accessories		
	Артикул №: 2002-161 Adaptor; gray	www.wago.com/2002-161
	Артикул №: 2009-110 Marking strips; for Smart Printer; on reel; not stretchable; plain; snap-on type; white	www.wago.com/2009-110
	Артикул №: 2009-115 WMB-Inline; for Smart Printer; 1500 pieces on roll; stretchable 5 - 5.2 mm; plain; snap-on type; white	www.wago.com/2009-115
	Артикул №: 2009-115/000-002 WMB-Inline; for Smart Printer; 1500 pieces on roll; stretchable 5 - 5.2 mm; plain; snap-on type; yellow	www.wago.com/2009-115/000-002
	Артикул №: 2009-115/000-005 WMB-Inline; for Smart Printer; 1500 pieces on roll; stretchable 5 - 5.2 mm; plain; snap-on type; red	www.wago.com/2009-115/000-005















Подлежи на промяна. Моля, обърнете внимание и на допълнителната документация на продукта!

	Артикул №: 2009-115/000-006 WMB-Inline; for Smart Printer; 1500 pieces on roll; stretchable 5 - 5.2 mm; plain; snap-on type; blue	www.wago.com/2009-115/000-006
	Артикул №: 2009-115/000-007 WMB-Inline; for Smart Printer; 1500 pieces on roll; stretchable 5 - 5.2 mm; plain; snap-on type; gray	www.wago.com/2009-115/000-007
	Артикул №: 2009-115/000-012 WMB-Inline; for Smart Printer; 1500 pieces on roll; stretchable 5 - 5.2 mm; plain; snap-on type; orange	www.wago.com/2009-115/000-012
	Артикул №: 2009-115/000-017 WMB-Inline; for Smart Printer; 1500 pieces on roll; stretchable 5 - 5.2 mm; plain; snap-on type; light green	www.wago.com/2009-115/000-017
	Артикул №: 2009-115/000-023 WMB-Inline; for Smart Printer; 1500 pieces on roll; stretchable 5 - 5.2 mm; plain; snap-on type; green	www.wago.com/2009-115/000-023
	Артикул №: 2009-115/000-024 WMB-Inline; for Smart Printer; 1500 pieces on roll; stretchable 5 - 5.2 mm; plain; snap-on type; violet	www.wago.com/2009-115/000-024
	Артикул №: 2009-145 Mini-WSB Inline; for Smart Printer; 1700 pieces on roll; stretchable 5 - 5.2 mm; plain; snap-on type; white	www.wago.com/2009-145
	Артикул №: 2009-145/000-002 Mini-WSB Inline; for Smart Printer; 1700 pieces on roll; stretchable 5 - 5.2 mm; plain; snap-on type; yellow	www.wago.com/2009-145/000-002
	Артикул №: 2009-145/000-005 Mini-WSB Inline; for Smart Printer; 1700 pieces on roll; stretchable 5 - 5.2 mm; plain; snap-on type; red	www.wago.com/2009-145/000-005
	Артикул №: 2009-145/000-006 Mini-WSB Inline; for Smart Printer; 1700 pieces on roll; stretchable 5 - 5.2 mm; plain; snap-on type; blue	www.wago.com/2009-145/000-006
	Артикул №: 2009-145/000-007 Mini-WSB Inline; for Smart Printer; 1700 pieces on roll; stretchable 5 - 5.2 mm; plain; snap-on type; gray	www.wago.com/2009-145/000-007
	Артикул №: 2009-145/000-012 Mini-WSB Inline; for Smart Printer; 1700 pieces on roll; stretchable 5 - 5.2 mm; plain; snap-on type; orange	www.wago.com/2009-145/000-012
	Артикул №: 2009-145/000-023 Mini-WSB Inline; for Smart Printer; 1700 pieces on roll; stretchable 5 - 5.2 mm; plain; snap-on type; green	www.wago.com/2009-145/000-023
	Артикул №: 2009-145/000-024 Mini-WSB Inline; for Smart Printer; 1700 pieces on roll; stretchable 5 - 5.2 mm; plain; snap-on type; violet	www.wago.com/2009-145/000-024

Подлежи на промяна. Моля, обърнете внимание и на допълнителната документация на продукта!

ВАГО България ООД
Бизнес център Сердика
Бул."Акад. Иван Гешов" 2Е | Сграда 1, ет. 4, офис 417 | 1330 София
Тел.: +359 2 489 46 09 | Тел.: +359 2 489 46 10
Имейл: sales.bg@wago.com

Имате ли въпроси относно нашите продукти?
Винаги ще се радваме да получим вашето обаждане на +359 2 489 46 09.

	Артикул №: 2009-191 Group marker carrier	www.wago.com/2009-191
	Артикул №: 2009-192 Group marker carrier	www.wago.com/2009-192
	Артикул №: 2009-193 Group marker carrier	www.wago.com/2009-193
	Артикул №: 2009-198 Adaptor; gray	www.wago.com/2009-198
	Артикул №: 248-501 Miniature WSB Quick marking system; plain; Marker width 5 mm; 10 strips with 10 markers per card	www.wago.com/248-501
	Артикул №: 248-501/000-002 Mini-WSB marking card; as card; not stretchable; plain; snap-on type; yellow	www.wago.com/248-501/000-002
	Артикул №: 248-501/000-005 Mini-WSB marking card; as card; not stretchable; plain; snap-on type; red	www.wago.com/248-501/000-005
	Артикул №: 248-501/000-006 Mini-WSB marking card; as card; not stretchable; plain; snap-on type; blue	www.wago.com/248-501/000-006
	Артикул №: 248-501/000-007 Mini-WSB marking card; as card; not stretchable; plain; snap-on type; gray	www.wago.com/248-501/000-007
	Артикул №: 248-501/000-012 Mini-WSB marking card; as card; not stretchable; plain; snap-on type; orange	www.wago.com/248-501/000-012
	Артикул №: 248-501/000-017 Mini-WSB marking card; as card; not stretchable; plain; snap-on type; light green	www.wago.com/248-501/000-017
	Артикул №: 248-501/000-023 Mini-WSB marking card; as card; not stretchable; plain; snap-on type; green	www.wago.com/248-501/000-023
	Артикул №: 248-501/000-024 Mini-WSB marking card; as card; not stretchable; plain; snap-on type; violet	www.wago.com/248-501/000-024
	Артикул №: 793-501 WMB marking card; as card; not stretchable; plain; snap-on type; white	www.wago.com/793-501
	Артикул №: 793-501/000-002 WMB marking card; as card; not stretchable; plain; snap-on type; yellow	www.wago.com/793-501/000-002

Подлежи на промяна. Моля, обърнете внимание и на допълнителната документация на продукта!

ВАГО България ООД
Бизнес център Сердика
Бул."Акад. Иван Гешов" 2Е | Сграда 1, ет. 4, офис 417 | 1330 София
Тел.: +359 2 489 46 09 | Тел.: +359 2 489 46 10
Имейл: sales.bg@wago.com

Имате ли въпроси относно нашите продукти?
Винаги ще се радваме да получим вашето обаждане на +359 2 489 46 09.



Артикул №: 793-501/000-005
WMB marking card; as card; not stretchable; plain; snap-on type; red

www.wago.com/793-501/000-005



Артикул №: 793-501/000-006
WMB marking card; as card; not stretchable; plain; snap-on type; blue

www.wago.com/793-501/000-006



Артикул №: 793-501/000-007
WMB marking card; as card; not stretchable; plain; snap-on type; gray

www.wago.com/793-501/000-007



Артикул №: 793-501/000-012
WMB marking card; as card; not stretchable; plain; snap-on type; orange

www.wago.com/793-501/000-012



Артикул №: 793-501/000-017
WMB marking card; as card; not stretchable; plain; snap-on type; light green

www.wago.com/793-501/000-017



Артикул №: 793-501/000-023
WMB marking card; as card; not stretchable; plain; snap-on type; green

www.wago.com/793-501/000-023



Артикул №: 793-501/000-024
WMB marking card; as card; not stretchable; plain; snap-on type; violet

www.wago.com/793-501/000-024



Артикул №: 793-5501
WMB marking card; as card; for terminal block width 5 - 17.5 mm; stretchable 5 - 5.2 mm; plain; snap-on type; white

www.wago.com/793-5501



Артикул №: 793-5501/000-002
WMB marking card; as card; for terminal block width 5 - 17.5 mm; stretchable 5 - 5.2 mm; plain; snap-on type; yellow

www.wago.com/793-5501/000-002



Артикул №: 793-5501/000-005
WMB marking card; as card; for terminal block width 5 - 17.5 mm; stretchable 5 - 5.2 mm; plain; snap-on type; red

www.wago.com/793-5501/000-005



Артикул №: 793-5501/000-006
WMB marking card; as card; for terminal block width 5 - 17.5 mm; stretchable 5 - 5.2 mm; plain; snap-on type; blue

www.wago.com/793-5501/000-006



Артикул №: 793-5501/000-007
WMB marking card; as card; for terminal block width 5 - 17.5 mm; stretchable 5 - 5.2 mm; plain; snap-on type; gray

www.wago.com/793-5501/000-007



Артикул №: 793-5501/000-012
WMB marking card; as card; for terminal block width 5 - 17.5 mm; stretchable 5 - 5.2 mm; plain; snap-on type; orange

www.wago.com/793-5501/000-012

Артикул №: 793-5501/000-014

Подлежи на промяна. Моля, обърнете внимание и на допълнителната документация на продукта!

ВАГО България ООД
Бизнес център Сердика
Бул."Акад. Иван Гешов" 2Е | Сграда 1, ет. 4, офис 417 | 1330 София
Тел.: +359 2 489 46 09 | Тел.: +359 2 489 46 10
Имейл: sales.bg@wago.com

Имате ли въпроси относно нашите продукти?
Винаги ще се радваме да получим вашето обаждане на +359 2 489 46 09.



WMB marking card; as card; for terminal block width 5 - 17.5 mm; stretchable 5 - 5.2 mm; plain; snap-on type; brown

www.wago.com/793-5501/000-014



Артикул №: 793-5501/000-017

WMB marking card; as card; for terminal block width 5 - 17.5 mm; stretchable 5 - 5.2 mm; plain; snap-on type; green

www.wago.com/793-5501/000-017



Артикул №: 793-5501/000-023

WMB marking card; as card; for terminal block width 5 - 17.5 mm; stretchable 5 - 5.2 mm; plain; snap-on type; light green

www.wago.com/793-5501/000-023



Артикул №: 793-5501/000-024

WMB marking card; as card; for terminal block width 5 - 17.5 mm; stretchable 5 - 5.2 mm; plain; snap-on type; violet

www.wago.com/793-5501/000-024

Изтегляния

Documentation

Bid Text

2002-1207 docx - Datei	Apr 23, 2019	docx 14,9 kB	Изтегляне
---------------------------	--------------	-----------------	-----------

2002-1207 X81 - Datei	Apr 29, 2019	xml 3,9 kB	Изтегляне
--------------------------	--------------	---------------	-----------

Additional Information

Technical explanations	Apr 3, 2019	pdf 2,2 MB	Изтегляне
------------------------	-------------	---------------	-----------

CAD/CAE-Data

CAD data

2D/3D Models 2002-1207	URL	Изтегляне
------------------------	-----	-----------

CAE data

EPLAN Data Portal 2002-1207	URL	Изтегляне
-----------------------------	-----	-----------

WSCAD Universe 2002-1207	URL	Изтегляне
--------------------------	-----	-----------

ZUKEN Portal 2002-1207	URL	Изтегляне
------------------------	-----	-----------

Подлежи на промяна. Моля, обърнете внимание и на допълнителната документация на продукта!

ВАГО България ООД
Бизнес център Сердика
Бул."Акад. Иван Гешов" 2Е | Сграда 1, ет. 4, офис 417 | 1330 София
Тел.: +359 2 489 46 09 | Тел.: +359 2 489 46 10
Имейл: sales.bg@wago.com

Имате ли въпроси относно нашите продукти?
Винаги ще се радваме да получим вашето обаждане на +359 2 489 46 09.

Бележки за инсталиране

Conductor termination

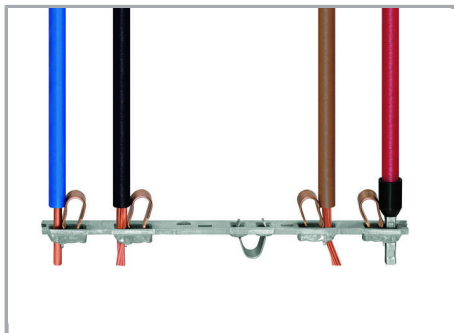

All conductor types at a glance

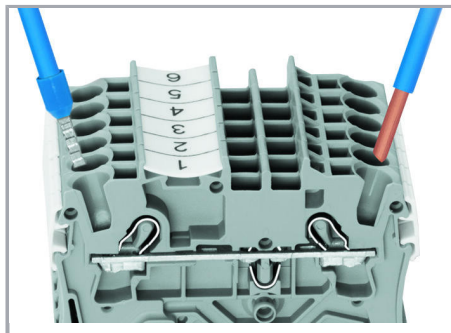

Terminating solid and ferruled conductors via push-in connection.

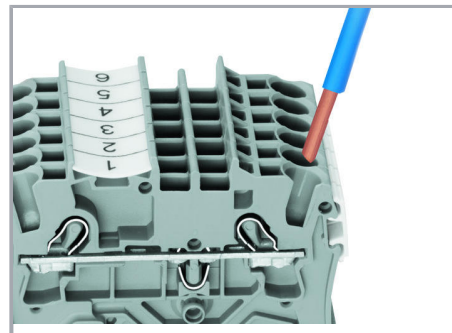

Inserting conductors via push-in termination.

Solid conductors with cross-sections from either one size above, or up to two sizes below, the rated cross-section can be simply pushed in – no tools needed.

Подлежи на промяна. Моля, обърнете внимание и на допълнителната документация на продукта!

ВАГО България ООД
Бизнес център Сердика
Бул."Акад. Иван Гешов" 2Е | Сграда 1, ет. 4, офис 417 | 1330 София
Тел.: +359 2 489 46 09 | Тел.: +359 2 489 46 10
Имейл: sales.bg@wago.com

Имате ли въпроси относно нашите продукти?
Винаги ще се радваме да получим вашето обаждане на +359 2 489 46 09.

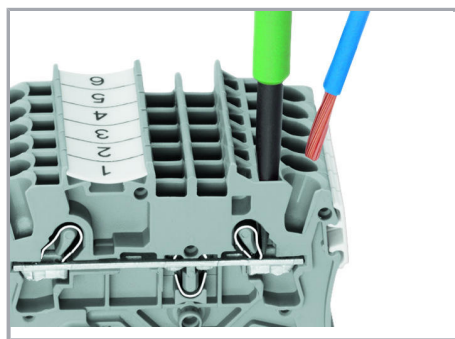

Inserting a conductor via operating tool.

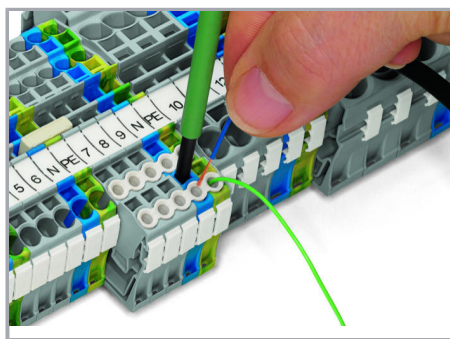

Conductor termination – Insulation stop.

Connecting fine-stranded conductors without ferrules, or small cross-sectional conductors that cannot be pushed in, is performed similarly to the original CAGE CLAMP® – just use an operating tool.

The smart feature:

To open the clamp, the operating tool is inserted vertically. The conductor entry is less than 15 degrees for easier wiring.

Commoning

Подлежи на промяна. Моля, обърнете внимание и на допълнителната документация на продукта!

ВАГО България ООД
Бизнес център Сердика
Бул."Акад. Иван Гешов" 2Е | Сграда 1, ет. 4, офис 417 | 1330 София
Тел.: +359 2 489 46 09 | Тел.: +359 2 489 46 10
Имейл: sales.bg@wago.com

Имате ли въпроси относно нашите продукти?
Винаги ще се радваме да получим вашето обаждане на +359 2 489 46 09.

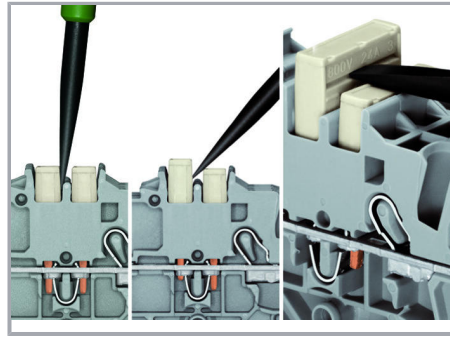
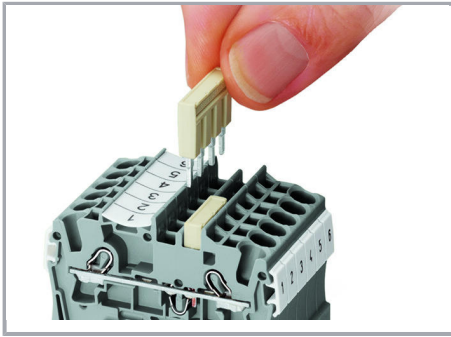

The push-in type jumper bar system is based on the common plug and socket principle. Each terminal block is spring-loaded with a double socket and a resilient CrNi steel spring. The jumper contact material is pure electrolytic copper, which allows for an extremely small design capable of carrying the full-rated current of the terminal block. Ground terminal blocks can also be commoned using the same jumper system. Custom jumpers are created by breaking and removing jumper contacts (2000, 2001, 2002, 2004 Series).

Removing a push-in type jumper bar.

Insert the operating tool between the jumper and the partition wall of the dual jumper slots, then lift up the jumper.

Place the operating tool in the center of jumpers up to five contacts (see above), or alternately on both sides for jumpers with more than five contacts.

Commoning

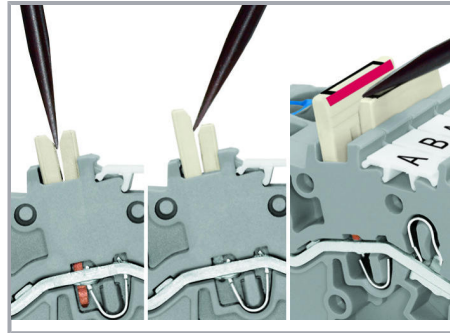
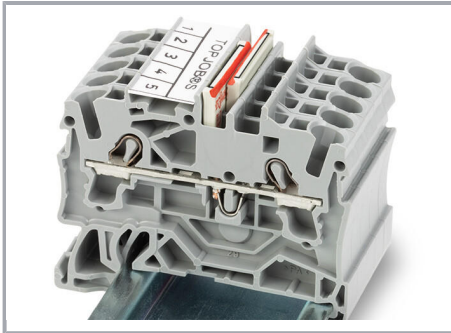

Locate red stripes of the staggered jumpers on the inside.

Removing a staggered jumper:

Insert staggered jumper and push down until it hits backstop.

Insert the operating tool between the staggered jumpers, then lift up the jumper.

Commoning

Подлежи на промяна. Моля, обърнете внимание и на допълнителната документация на продукта!

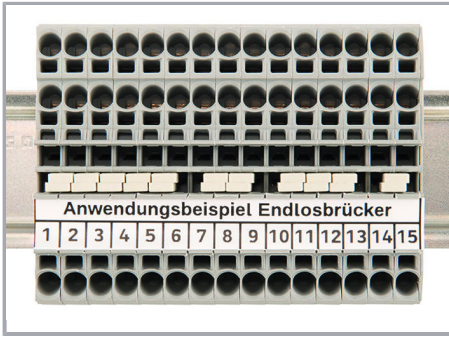

Continuous jumpers (2002 Series) readily connect an endless number of terminal blocks to each other via a single jumper slot. Use the second jumper slot for additional commoning or testing.

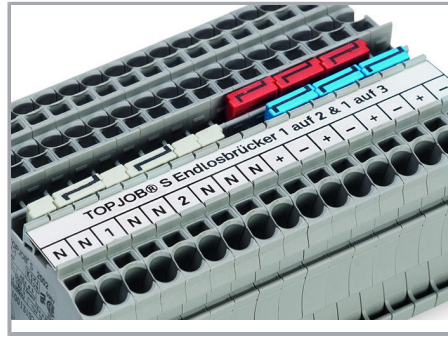

The 1-to-3 adjacent jumper for continuous commoning enables every other terminal block to be commoned. For example, positive and negative potentials can be accommodated alongside each other.

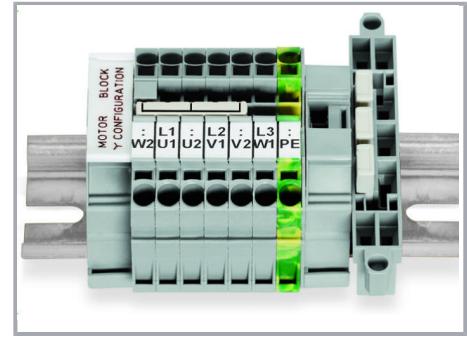

This star point jumper has been specially developed to create a "star point" and is used on motor terminal boards equipped with TOPJOB® S rail-mount terminal blocks.

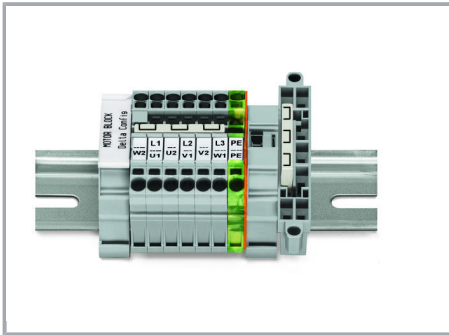

This delta jumper has been specially developed to create a delta configuration and is used on motor terminal boards equipped with TOPJOB® S rail-mount terminal blocks.

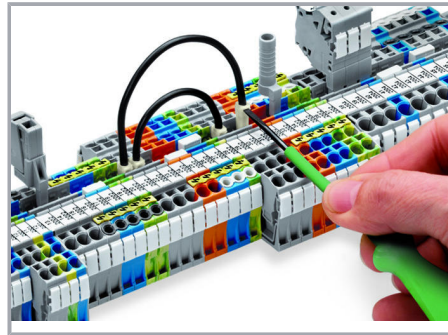

Push down the wire jumper until fully inserted. Lift the jumper with an operating tool for rewiring.

Testing

Подлежи на промяна. Моля, обърнете внимание и на допълнителната документация на продукта!

ВАГО България ООД
 Бизнес център Сердика
 Бул."Акад. Иван Гешов" 2Е | Сграда 1, ет. 4, офис 417 | 1330 София
 Тел.: +359 2 489 46 09 | Тел.: +359 2 489 46 10
 Имейл: sales.bg@wago.com

Имате ли въпроси относно нашите продукти?
 Винаги ще се радваме да получим вашето обаждане на +359 2 489 46 09.

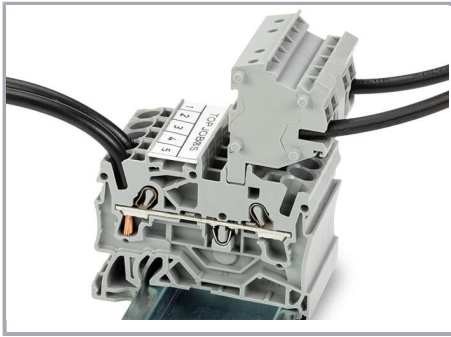

The modular TOPJOB® S connectors also connect conductors of the same size as the terminal blocks being used.

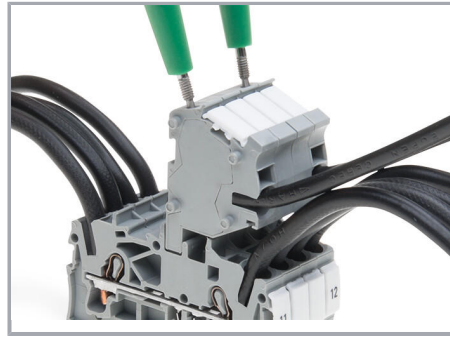

TOPJOB® S Connectors with a 2 mm Ø test socket for testing voltage via 2-pole voltage tester

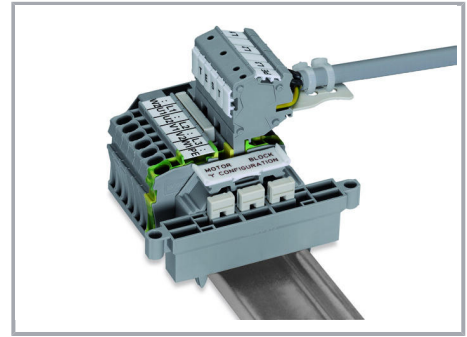

Rail-mount terminal block assembly for electric motor wiring

Подлежи на промяна. Моля, обърнете внимание и на допълнителната документация на продукта!

ВАГО България ООД
Бизнес център Сердика
Бул."Акад. Иван Гешов" 2Е | Сграда 1, ет. 4, офис 417 | 1330 София
Тел.: +359 2 489 46 09 | Тел.: +359 2 489 46 10
Имейл: sales.bg@wago.com

Имате ли въпроси относно нашите продукти?
Винаги ще се радваме да получим вашето обаждане на +359 2 489 46 09.

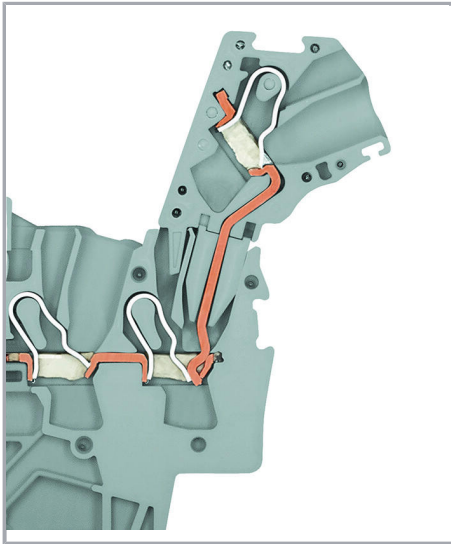

L-type test plug module – cross-sectional view of contacts

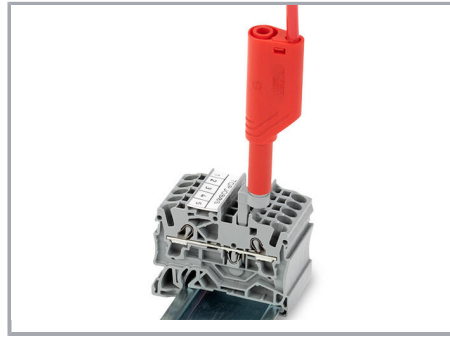

Test plug adapter (2009-174, CAT I) for 4 mm Ø plugs – compatible with 2000 to 2016 Series

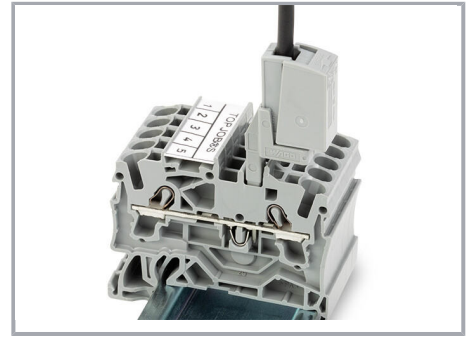

Testing tap (2009-182) for tool-free connection of test cables up to 2.5 mm² (12 AWG) – compatible with 2000 to 2016 Series

Marking

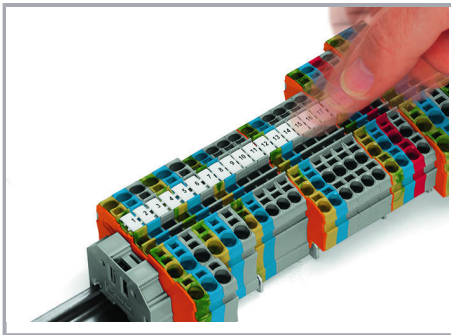

Snapping WMB Inline markers into marker slots.

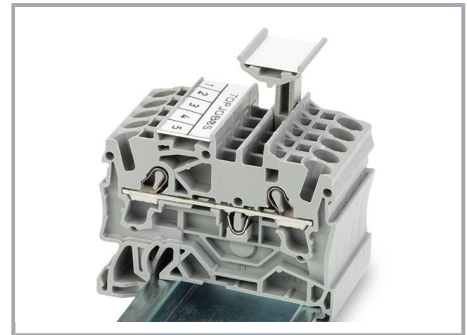
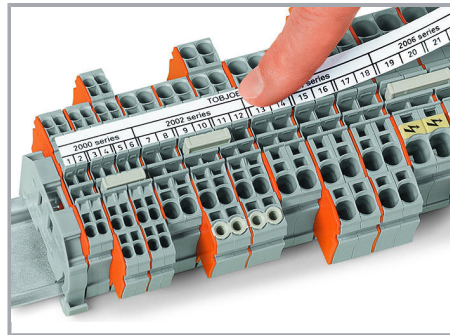

TOPJOB® S 2009-193 Group Marker Carrier (equipped with a marking strip) for all 2001 to 2016 Series TOPJOB® S Rail-Mount Terminal Blocks

Do not use on an end plate!

Подлежи на промяна. Моля, обърнете внимание и на допълнителната документация на продукта!

ВАГО България ООД
Бизнес център Сердика
Бул."Акад. Иван Гешов" 2Е | Сграда 1, ет. 4, офис 417 | 1330 София
Тел.: +359 2 489 46 09 | Тел.: +359 2 489 46 10
Имейл: sales.bg@wago.com

Имате ли въпроси относно нашите продукти?
Винаги ще се радваме да получим вашето обаждане на +359 2 489 46 09.

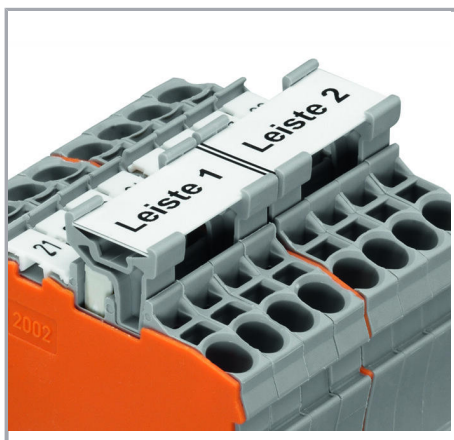

Using marker carriers for marking strips (2002-161) in jumper slots.

Семейство продукти

TOPJOB® S

TOPJOB® S: In various industrial applications and modern building installations, WAGO's wide and versatile range of rail-mount terminal blocks provides more than just reliable electrical connections.

Показване на всички продукти от семейството.

Подлежи на промяна. Моля, обърнете внимание и на допълнителната документация на продукта!

ВАГО България ООД
Бизнес център Сердика
Бул."Акад. Иван Гешов" 2Е | Сграда 1, ет. 4, офис 417 | 1330 София
Тел.: +359 2 489 46 09 | Тел.: +359 2 489 46 10
Имейл: sales.bg@wago.com

Имате ли въпроси относно нашите продукти?
Винаги ще се радваме да получим вашето обаждане на +359 2 489 46 09.