

Информационен лист | Номер на артикул: 2002-1204

2-conductor through terminal block; 2.5 mm²; for Ex e II and Ex i applications;
side and center marking; for DIN-rail 35 x 15 and 35 x 7.5; Push-in CAGE
CLAMP®; 2,50 mm²; blue

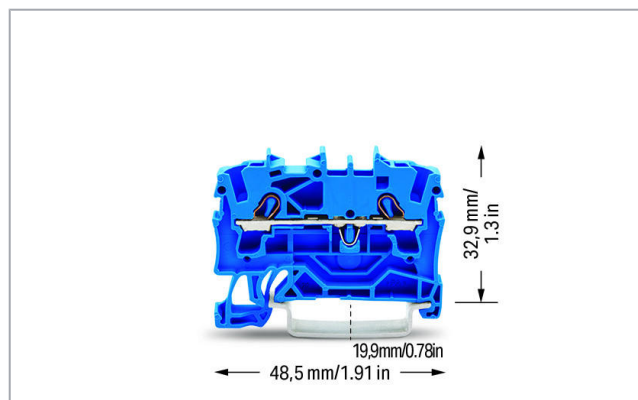

www.wago.com/2002-1204

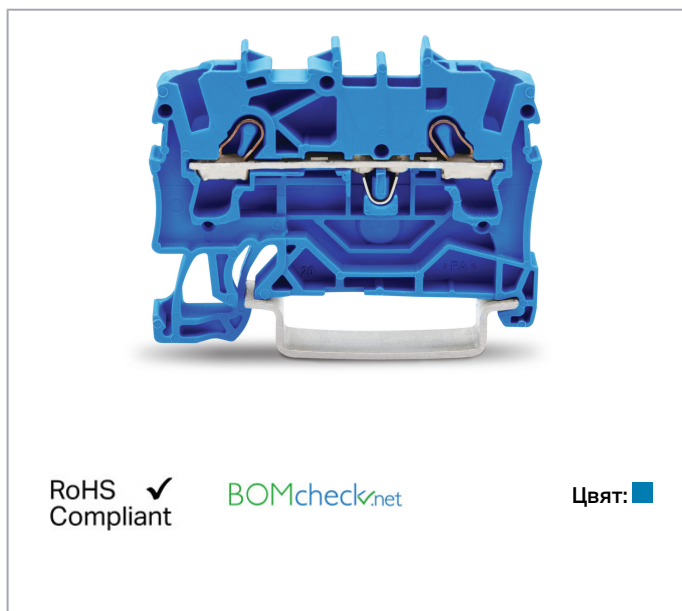

Данни

Electrical data

Ratings per IEC/EN 60664-1

Ratings per	IEC/EN 60947-7-1
Nominal voltage (III/3)	800 V
Rated surge voltage (III/3)	8 kV
Rated current	24 A
Rated current 2	32 A
Legend (ratings)	(III / 3) ≙ Overvoltage category III / Pollution degree 3

Ratings per UL 1059

Approvals per	UL 1059
Rated voltage UL (Use Group B)	600 V
Rated current UL (Use Group B)	20 A
Rated voltage UL (Use Group C)	600 V
Rated current UL (Use Group C)	20 A

Подлежи на промяна. Моля, обърнете внимание и на допълнителната документация на продукта!

ВАГО България ООД
Бизнес център Сердика
Бул."Акад. Иван Гешов" 2Е | Сграда 1, ет. 4, офис 417 | 1330 София
Тел.: +359 2 489 46 09 | Тел.: +359 2 489 46 10
Имейл: sales.bg@wago.com

Имате ли въпроси относно нашите продукти?
Винаги ще се радваме да получим вашето обаждане на +359 2 489 46 09.



Ratings per CSA

Rated voltage CSA (Use Group B)	600 V
Rated current CSA (Use Group B)	20 A
Rated voltage CSA (Use Group C)	600 V
Rated current CSA (Use Group C)	20 A

Ex information

Rated voltage EN (Ex e II)	550 V
Rated current (Ex e II)	22 A
Rated current (Ex e II) with jumper	20 A

Connection data

Connection technology	Push-in CAGE CLAMP®
Actuation type	Push-in Operating tool
Connectable conductor materials	Copper
Nominal cross-section	2,5 mm ²
Solid conductor	0,25 ... 4 mm ² / 22 ... 12 AWG
Solid conductor; push-in termination	0,75 ... 4 mm ² / 18 ... 12 AWG
Fine-stranded conductor	0,25 ... 4 mm ² / 22 ... 12 AWG
Fine-stranded conductor; with insulated ferrule	1 ... 2,5 mm ² / 18 ... 14 AWG
Fine-stranded conductor; with ferrule; push-in termination	1 ... 2,5 mm ² / 18 ... 14 AWG
Note (conductor cross-section)	Depending on the conductor characteristic, a conductor with a smaller cross-section can also be inserted via push-in termination.
Strip length	10 ... 12 mm / 0.39 ... 0.47 inch
Total number of connection points	2
Total number of potentials	1
Number of levels	1
Wiring type	Front-entry wiring
Number of jumper slots	2

Physical data

Width	5,2 mm / 0.205 inch
Height from upper-edge of DIN-rail	32,9 mm / 1.295 inch
Depth	48,5 mm / 1.909 inch

Подлежи на промяна. Моля, обърнете внимание и на допълнителната документация на продукта!

ВАГО България ООД
 Бизнес център Сердика
 Бул."Акад. Иван Гешов" 2Е | Сграда 1, ет. 4, офис 417 | 1330 София
 Тел.: +359 2 489 46 09 | Тел.: +359 2 489 46 10
 Имейл: sales.bg@wago.com

Имате ли въпроси относно нашите продукти?
 Винаги ще се радваме да получим вашето обаждане на +359 2 489 46 09.

Mechanical data

Design	horizontal type
Mounting type	DIN-35 rail
Marking level	Center/side marking

Material Data





Color	blue
Insulation material	Polyamide (PA66)
Fire load	0,109 MJ
Weight	4,9 g

Commercial data

Product Group	22 (TOPJOB S)
Packaging type	BOX
Country of origin	DE
GTIN	4017332999175
Customs tariff number	85369010000

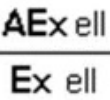
Одобрения / Сертификати

Ex-Approvals

Лого	Одобрение	Допълнителен текст за одобрение	Име на сертификат
 AEx ell Ex ell	AEx Underwriters Laboratories Inc.	UL 60079	20190704-E185892
	ATEX Physikalisch Technische Bundesanstalt (PTB)	EN 60079	PTB 03 ATEX 1162 U (II 2 G/D Ex e II bzw. I M 2 Ex e I)
 Ex e IIC Gb Ex e I Mb	CCCEX CQST/CNEX	CNCA-C23-01	2020312313000238
	IECEX Physikalisch Technische Bundesanstalt	IEC 60079	IECEX PTB 03.0004 U (Ex eb IIC Gb or Ex eb I Mb)

Country specific Approvals

Подлежи на промяна. Моля, обърнете внимание и на допълнителната документация на продукта!

ВАГО България ООД
 Бизнес център Сердика
 Бул."Акад. Иван Гешов" 2Е | Сграда 1, ет. 4, офис 417 | 1330 София
 Тел.: +359 2 489 46 09 | Тел.: +359 2 489 46 10
 Имейл: sales.bg@wago.com

Имате ли въпроси относно нашите продукти?
 Винаги ще се радваме да получим вашето обаждане на +359 2 489 46 09.

Лого	Одобрение	Допълнителен текст за одобрение	Име на сертификат
	CCA DEKRA Certification B.V.	EN 60947	NTR NL 7730
	CSA DEKRA Certification B.V.	C22.2 No. 158	1536069
	EAC Brjansker Zertifizierungsstelle	TP TC 012/2011	RU C-DE. AM02.B. 00127/19
	KEMA/KEUR DEKRA Certification B.V.	EN 60947	71-107687

Ship Approvals

Лого	Одобрение	Допълнителен текст за одобрение	Име на сертификат
	ABS American Bureau of Shipping	EN 60947	20- HG1941090- PDA
	BV Bureau Veritas S.A.	EN 60947	38586/A0 BV
	DNV GL Det Norske Veritas, Germanischer Lloyd	-	TAE00001V2
	LR Lloyds Register	EN 60947	91/20112 (E9)

UL-Approvals

Лого	Одобрение	Допълнителен текст за одобрение	Име на сертификат
	cURus Underwriters Laboratories Inc.	UL 1059	20190731- E45172

Подлежи на промяна. Моля, обърнете внимание и на допълнителната документация на продукта!



ВАГО България ООД
Бизнес център Сердика
Бул."Акад. Иван Гешов" 2Е | Сграда 1, ет. 4, офис 417 | 1330 София
Тел.: +359 2 489 46 09 | Тел.: +359 2 489 46 10
Имейл: sales.bg@wago.com

Имате ли въпроси относно нашите продукти?
Винаги ще се радваме да получим вашето обаждане на +359 2 489 46 09.







Изискват се аксесоари

End plate





	Артикул №: 2002-1291 End and intermediate plate; 0.8 mm thick; gray	www.wago.com/2002-1291
	Артикул №: 2002-1292 End and intermediate plate; 0.8 mm thick; orange	www.wago.com/2002-1292

Съвместими продукти

Push-In type wire jumper

	Артикул №: 2009-412 Push-in type wire jumper; insulated; 60 mm long; black	www.wago.com/2009-412
	Артикул №: 2009-414 Push-in type wire jumper; 1.5 mm ² ; insulated; 110 mm long; black	www.wago.com/2009-414
	Артикул №: 2009-414/000-005 Push-in type wire jumper; 1.5 mm ² ; insulated; 110 mm long; black	www.wago.com/2009-414/000-005
	Артикул №: 2009-414/000-006 Push-in type wire jumper; insulated; 110 mm long; black	www.wago.com/2009-414/000-006
	Артикул №: 2009-416 Push-in type wire jumper; 1.5 mm ² ; insulated; 250 mm long; black	www.wago.com/2009-416















Jumper

	Артикул №: 2002-400 Continuous jumper; 2-way; insulated; light gray	www.wago.com/2002-400
	Артикул №: 2002-402 Jumper; 2-way; insulated; light gray	www.wago.com/2002-402
	Артикул №: 2002-402/000-005 Jumper; 2-way; insulated; red	www.wago.com/2002-402/000-005
	Артикул №: 2002-402/000-006 Jumper; 2-way; insulated; blue	www.wago.com/2002-402/000-006

Подлежи на промяна. Моля, обърнете внимание и на допълнителната документация на продукта!

ВАГО България ООД
Бизнес център Сердика
Бул."Акад. Иван Гешов" 2Е | Сграда 1, ет. 4, офис 417 | 1330 София
Тел.: +359 2 489 46 09 | Тел.: +359 2 489 46 10
Имейл: sales.bg@wago.com















Имате ли въпроси относно нашите продукти?
Винаги ще се радваме да получим вашето обаждане на +359 2 489 46 09.

	Артикул №: 2002-403 Jumper; 3-way; insulated; light gray	www.wago.com/2002-403
	Артикул №: 2002-403/000-005 Jumper; 3-way; insulated; red	www.wago.com/2002-403/000-005
	Артикул №: 2002-403/000-006 Jumper; 3-way; insulated; blue	www.wago.com/2002-403/000-006
	Артикул №: 2002-404 Jumper; 4-way; insulated; light gray	www.wago.com/2002-404
	Артикул №: 2002-404/000-005 Jumper; 4-way; insulated; red	www.wago.com/2002-404/000-005
	Артикул №: 2002-404/000-006 Jumper; 4-way; insulated; blue	www.wago.com/2002-404/000-006
	Артикул №: 2002-405 Jumper; 5-way; insulated; light gray	www.wago.com/2002-405
	Артикул №: 2002-405/000-005 Jumper; 5-way; insulated; red	www.wago.com/2002-405/000-005
	Артикул №: 2002-405/000-006 Jumper; 5-way; insulated; blue	www.wago.com/2002-405/000-006
	Артикул №: 2002-405/011-000 Star point jumper; 3-way; insulated; light gray	www.wago.com/2002-405/011-000
	Артикул №: 2002-406 Jumper; 6-way; insulated; light gray	www.wago.com/2002-406
	Артикул №: 2002-406/000-005 Jumper; 6-way; insulated; red	www.wago.com/2002-406/000-005
	Артикул №: 2002-406/000-006 Jumper; 6-way; insulated; blue	www.wago.com/2002-406/000-006
	Артикул №: 2002-406/020-000 Delta jumper; insulated; light gray	www.wago.com/2002-406/020-000

Подлежи на промяна. Моля, обърнете внимание и на допълнителната документация на продукта!

ВАГО България ООД
Бизнес център Сердика
Бул."Акад. Иван Гешов" 2Е | Сграда 1, ет. 4, офис 417 | 1330 София
Тел.: +359 2 489 46 09 | Тел.: +359 2 489 46 10
Имейл: sales.bg@wago.com







Имате ли въпроси относно нашите продукти?
Винаги ще се радваме да получим вашето обаждане на +359 2 489 46 09.

	Артикул №: 2002-407 Jumper; 7-way; insulated; light gray	www.wago.com/2002-407
	Артикул №: 2002-407/000-005 Jumper; 7-way; insulated; red	www.wago.com/2002-407/000-005
	Артикул №: 2002-407/000-006 Jumper; 7-way; insulated; blue	www.wago.com/2002-407/000-006
	Артикул №: 2002-408 Jumper; 8-way; insulated; light gray	www.wago.com/2002-408
	Артикул №: 2002-408/000-005 Jumper; 8-way; insulated; red	www.wago.com/2002-408/000-005
	Артикул №: 2002-408/000-006 Jumper; 8-way; insulated; blue	www.wago.com/2002-408/000-006
	Артикул №: 2002-409 Jumper; 9-way; insulated; light gray	www.wago.com/2002-409
	Артикул №: 2002-409/000-005 Jumper; 9-way; insulated; red	www.wago.com/2002-409/000-005
	Артикул №: 2002-409/000-006 Jumper; 9-way; insulated; blue	www.wago.com/2002-409/000-006
	Артикул №: 2002-410 Jumper; 10-way; insulated; light gray	www.wago.com/2002-410
	Артикул №: 2002-410/000-005 Jumper; 10-way; insulated; red	www.wago.com/2002-410/000-005
	Артикул №: 2002-410/000-006 Jumper; 10-way; insulated; blue	www.wago.com/2002-410/000-006
	Артикул №: 2002-423 Continuous jumper; from 1 to 3; insulated; light gray	www.wago.com/2002-423
	Артикул №: 2002-423/000-005 Continuous jumper; from 1 to 3; insulated; red	www.wago.com/2002-423/000-005
	Артикул №: 2002-423/000-006 Continuous jumper; from 1 to 3; insulated; blue	www.wago.com/2002-423/000-006

Подлежи на промяна. Моля, обърнете внимание и на допълнителната документация на продукта!

ВАГО България ООД
 Бизнес център Сердика
 Бул."Акад. Иван Гешов" 2Е | Сграда 1, ет. 4, офис 417 | 1330 София
 Тел.: +359 2 489 46 09 | Тел.: +359 2 489 46 10
 Имейл: sales.bg@wago.com















Имате ли въпроси относно нашите продукти?
 Винаги ще се радваме да получим вашето обаждане на +359 2 489 46 09.

	Артикул №: 2002-433 Jumper; from 1 to 3; insulated; light gray	www.wago.com/2002-433
	Артикул №: 2002-434 Jumper; from 1 to 4; insulated; light gray	www.wago.com/2002-434
	Артикул №: 2002-435 Jumper; from 1 to 5; insulated; light gray	www.wago.com/2002-435
	Артикул №: 2002-436 Jumper; from 1 to 6; insulated; light gray	www.wago.com/2002-436
	Артикул №: 2002-437 Jumper; from 1 to 7; insulated; light gray	www.wago.com/2002-437
	Артикул №: 2002-438 Jumper; from 1 to 8; insulated; light gray	www.wago.com/2002-438
	Артикул №: 2002-439 Jumper; from 1 to 9; insulated; light gray	www.wago.com/2002-439
	Артикул №: 2002-440 Jumper; from 1 to 10; insulated; light gray	www.wago.com/2002-440
	Артикул №: 2002-472 Staggered jumper; 2-way; insulated; light gray	www.wago.com/2002-472
	Артикул №: 2002-473 Staggered jumper; 3-way; insulated; light gray	www.wago.com/2002-473
	Артикул №: 2002-473/011-000 Staggered jumper; 2-way; from 1 to 3; insulated; light gray	www.wago.com/2002-473/011-000
	Артикул №: 2002-474 Staggered jumper; 4-way; insulated; light gray	www.wago.com/2002-474
	Артикул №: 2002-475 Staggered jumper; 5-way; insulated; light gray	www.wago.com/2002-475
	Артикул №: 2002-475/011-000 Staggered jumper; 3-way; insulated; light gray	www.wago.com/2002-475/011-000
	Артикул №: 2002-476 Staggered jumper; 6-way; insulated; light gray	www.wago.com/2002-476
	Артикул №: 2002-477 Staggered jumper; 7-way; insulated; light gray	www.wago.com/2002-477
	Артикул №: 2002-477/011-000 Staggered jumper; insulated; light gray	www.wago.com/2002-477/011-000

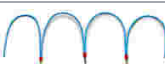
Подлежи на промяна. Моля, обърнете внимание и на допълнителната документация на продукта!

ВАГО България ООД
Бизнес център Сердика
Бул."Акад. Иван Гешов" 2Е | Сграда 1, ет. 4, офис 417 | 1330 София
Тел.: +359 2 489 46 09 | Тел.: +359 2 489 46 10
Имейл: sales.bg@wago.com













Имате ли въпроси относно нашите продукти?
Винаги ще се радваме да получим вашето обаждане на +359 2 489 46 09.

	Артикул №: 2002-478 Staggered jumper; 8-way; insulated; light gray	www.wago.com/2002-478
	Артикул №: 2002-479 Staggered jumper; 9-way; insulated; light gray	www.wago.com/2002-479
	Артикул №: 2002-479/011-000 Staggered jumper; insulated; light gray	www.wago.com/2002-479/011-000
	Артикул №: 2002-480 Staggered jumper; 10-way; insulated; light gray	www.wago.com/2002-480
	Артикул №: 2002-481 Staggered jumper; 11-way; insulated; light gray	www.wago.com/2002-481
	Артикул №: 2002-481/011-000 Staggered jumper; insulated; light gray	www.wago.com/2002-481/011-000
	Артикул №: 2002-482 Staggered jumper; 12-way; insulated; light gray	www.wago.com/2002-482
	Артикул №: 2006-499 Step-down jumper; insulated; light gray	www.wago.com/2006-499
	Артикул №: 2016-499 Step-down jumper; insulated; light gray	www.wago.com/2016-499
	Артикул №: 210-103 Wire commoning chain; insulated; black	www.wago.com/210-103
	Артикул №: 210-123 Wire commoning chain; insulated; blue	www.wago.com/210-123
tools		
	Артикул №: 210-658 Operating tool; Blade: 3.5 x 0.5 mm; with a partially insulated shaft; angled; short; multicoloured	www.wago.com/210-658
	Артикул №: 210-720 Operating tool; Blade: 3.5 x 0.5 mm; with a partially insulated shaft; multicoloured	www.wago.com/210-720
ferrule		
	Артикул №: 216-241 Ferrule; Sleeve for 0.5 mm ² / 20 AWG; insulated; electro-tin plated; electrolytic copper; gastight crimped; acc. to DIN 46228, Part 4/09.90; white	www.wago.com/216-241
	Артикул №: 216-242 Ferrule; Sleeve for 0.75 mm ² / 18 AWG; insulated; electro-tin plated; electrolytic copper; gastight crimped; acc. to DIN 46228, Part 4/09.90; gray	www.wago.com/216-242
	Артикул №: 216-243 Ferrule; Sleeve for 1 mm ² / AWG 18; insulated; electro-tin plated; electrolytic copper; gastight crimped; acc. to DIN 46228, Part 4/09.90; red	www.wago.com/216-243
	Артикул №: 216-244	

Подлежи на промяна. Моля, обърнете внимание и на допълнителната документация на продукта!

ВАГО България ООД
Бизнес център Сердика
Бул."Акад. Иван Гешов" 2Е | Сграда 1, ет. 4, офис 417 | 1330 София
Тел.: +359 2 489 46 09 | Тел.: +359 2 489 46 10
Имейл: sales.bg@wago.com

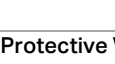















Имате ли въпроси относно нашите продукти?
Винаги ще се радваме да получим вашето обаждане на +359 2 489 46 09.

	Ferrule; Sleeve for 1.5 mm ² / AWG 16; insulated; electro-tin plated; electrolytic copper; gastight crimped; acc. to DIN 46228, Part 4/09.90; black	www.wago.com/216-244
	Артикул №: 216-246 Ferrule; Sleeve for 2.5 mm ² / AWG 14; insulated; electro-tin plated; electrolytic copper; gastight crimped; acc. to DIN 46228, Part 4/09.90; blue	www.wago.com/216-246
	Артикул №: 216-262 Ferrule; Sleeve for 0.75 mm ² / 18 AWG; insulated; electro-tin plated; electrolytic copper; gastight crimped; acc. to DIN 46228, Part 4/09.90; gray	www.wago.com/216-262
	Артикул №: 216-263 Ferrule; Sleeve for 1 mm ² / AWG 18; insulated; electro-tin plated; electrolytic copper; gastight crimped; acc. to DIN 46228, Part 4/09.90; red	www.wago.com/216-263
	Артикул №: 216-264 Ferrule; Sleeve for 1.5 mm ² / AWG 16; insulated; electro-tin plated; electrolytic copper; gastight crimped; acc. to DIN 46228, Part 4/09.90; black	www.wago.com/216-264
	Артикул №: 216-266 Ferrule; Sleeve for 2.5 mm ² / AWG 14; insulated; electro-tin plated; electrolytic copper; gastight crimped; acc. to DIN 46228, Part 4/09.90; blue	www.wago.com/216-266
plug		
	Артикул №: 2002-880 Empty component plug housing; 10.4 mm wide; 2-pole; Type 4; gray	www.wago.com/2002-880
	Артикул №: 2002-880/1000-411 Component plug; 2-pole; with diode 1N4007; 10.4 mm wide; Operating temperature 85°C max.; gray	www.wago.com/2002-880/1000-411
	Артикул №: 2002-880/1000-541 Component plug; 2-pole; LED (red); 10.4 mm wide; Operating temperature 85°C max.; gray	www.wago.com/2002-880/1000-541
	Артикул №: 2002-880/1000-542 Component plug; 2-pole; LED (red); 10.4 mm wide; Operating temperature 85°C max.; multicoloured	www.wago.com/2002-880/1000-542
	Артикул №: 2002-880/1000-836 Component plug; 2-pole; LED (red); 10.4 mm wide; Operating temperature 85°C max.; gray	www.wago.com/2002-880/1000-836
Protective Warning Marker		
	Артикул №: 2002-115 Protective warning marker; with high-voltage symbol, black; for 5 terminal blocks; yellow	www.wago.com/2002-115
Carrier rail		
	Артикул №: 210-112 Steel carrier rail; 35 x 7.5 mm; 1 mm thick; 2 m long; slotted; according to EN 60715; "Hole width 25 mm; silver-colored	www.wago.com/210-112
	Артикул №: 210-113 Steel carrier rail; 35 x 7.5 mm; 1 mm thick; 2 m long; unslotted; according to EN 60715; silver-colored	www.wago.com/210-113

Подлежи на промяна. Моля, обърнете внимание и на допълнителната документация на продукта!

ВАГО България ООД
Бизнес център Сердика
Бул."Акад. Иван Гешов" 2Е | Сграда 1, ет. 4, офис 417 | 1330 София
Тел.: +359 2 489 46 09 | Тел.: +359 2 489 46 10
Имейл: sales.bg@wago.com















Имате ли въпроси относно нашите продукти?
Винаги ще се радваме да получим вашето обаждане на +359 2 489 46 09.

	Артикул №: 210-114 Steel carrier rail; 35 x 15 mm; 1.5 mm thick; 2 m long; unslotted; similar to EN 60715; silver-colored	www.wago.com/210-114
	Артикул №: 210-115 Steel carrier rail; 35 x 7.5 mm; 1 mm thick; 2 m long; slotted; according to EN 60715; "Hole width 18 mm; silver-colored	www.wago.com/210-115
	Артикул №: 210-118 Steel carrier rail; 35 x 15 mm; 2.3 mm thick; 2 m long; unslotted; according to EN 60715; silver-colored	www.wago.com/210-118
	Артикул №: 210-196 Aluminum carrier rail; 35 x 8.2 mm; 1.6 mm thick; 2 m long; unslotted; similar to EN 60715; silver-colored	www.wago.com/210-196
	Артикул №: 210-197 Steel carrier rail; 35 x 15 mm; 1.5 mm thick; 2 m long; slotted; similar to EN 60715; silver-colored	www.wago.com/210-197
	Артикул №: 210-198 Copper carrier rail; 35 x 15 mm; 2.3 mm thick; 2 m long; unslotted; according to EN 60715; copper-colored	www.wago.com/210-198
	Артикул №: 210-504 Steel carrier rail; 35 x 7.5 mm; 1 mm thick; 2 m long; slotted; galvanized; according to EN 60715	www.wago.com/210-504
	Артикул №: 210-505 Steel carrier rail; 35 x 7.5 mm; 1 mm thick; 2 m long; unslotted; galvanized; according to EN 60715; silver-colored	www.wago.com/210-505
	Артикул №: 210-506 Steel carrier rail; 35 x 15 mm; 1.5 mm thick; 2 m long; unslotted; galvanized; similar to EN 60715; silver-colored	www.wago.com/210-506
	Артикул №: 210-508 Steel carrier rail; 35 x 15 mm; 1.5 mm thick; 2 m long; slotted; galvanized; similar to EN 60715; silver-colored	www.wago.com/210-508
Marking accessories		
	Артикул №: 2002-161 Adaptor; gray	www.wago.com/2002-161
	Артикул №: 2009-110 Marking strips; for Smart Printer; on reel; not stretchable; plain; snap-on type; white	www.wago.com/2009-110
	Артикул №: 2009-115 WMB-Inline; for Smart Printer; 1500 pieces on roll; stretchable 5 - 5.2 mm; plain; snap-on type; white	www.wago.com/2009-115
	Артикул №: 2009-115/000-002 WMB-Inline; for Smart Printer; 1500 pieces on roll; stretchable 5 - 5.2 mm; plain; snap-on type; yellow	www.wago.com/2009-115/000-002
	Артикул №: 2009-115/000-005 WMB-Inline; for Smart Printer; 1500 pieces on roll; stretchable 5 - 5.2 mm; plain; snap-on type; red	www.wago.com/2009-115/000-005
	Артикул №: 2009-115/000-006 WMB-Inline; for Smart Printer; 1500 pieces on roll; stretchable 5 - 5.2 mm; plain; snap-on type; blue	www.wago.com/2009-115/000-006

Подлежи на промяна. Моля, обърнете внимание и на допълнителната документация на продукта!

ВАГО България ООД
Бизнес център Сердика
Бул."Акад. Иван Гешов" 2Е | Сграда 1, ет. 4, офис 417 | 1330 София
Тел.: +359 2 489 46 09 | Тел.: +359 2 489 46 10
Имейл: sales.bg@wago.com















Имате ли въпроси относно нашите продукти?
Винаги ще се радваме да получим вашето обаждане на +359 2 489 46 09.

	Артикул №: 2009-115/000-007 WMB-Inline; for Smart Printer; 1500 pieces on roll; stretchable 5 - 5.2 mm; plain; snap-on type; gray	www.wago.com/2009-115/000-007
	Артикул №: 2009-115/000-012 WMB-Inline; for Smart Printer; 1500 pieces on roll; stretchable 5 - 5.2 mm; plain; snap-on type; orange	www.wago.com/2009-115/000-012
	Артикул №: 2009-115/000-017 WMB-Inline; for Smart Printer; 1500 pieces on roll; stretchable 5 - 5.2 mm; plain; snap-on type; light green	www.wago.com/2009-115/000-017
	Артикул №: 2009-115/000-023 WMB-Inline; for Smart Printer; 1500 pieces on roll; stretchable 5 - 5.2 mm; plain; snap-on type; green	www.wago.com/2009-115/000-023
	Артикул №: 2009-115/000-024 WMB-Inline; for Smart Printer; 1500 pieces on roll; stretchable 5 - 5.2 mm; plain; snap-on type; violet	www.wago.com/2009-115/000-024
	Артикул №: 2009-145 Mini-WSB Inline; for Smart Printer; 1700 pieces on roll; stretchable 5 - 5.2 mm; plain; snap-on type; white	www.wago.com/2009-145
	Артикул №: 2009-145/000-002 Mini-WSB Inline; for Smart Printer; 1700 pieces on roll; stretchable 5 - 5.2 mm; plain; snap-on type; yellow	www.wago.com/2009-145/000-002
	Артикул №: 2009-145/000-005 Mini-WSB Inline; for Smart Printer; 1700 pieces on roll; stretchable 5 - 5.2 mm; plain; snap-on type; red	www.wago.com/2009-145/000-005
	Артикул №: 2009-145/000-006 Mini-WSB Inline; for Smart Printer; 1700 pieces on roll; stretchable 5 - 5.2 mm; plain; snap-on type; blue	www.wago.com/2009-145/000-006
	Артикул №: 2009-145/000-007 Mini-WSB Inline; for Smart Printer; 1700 pieces on roll; stretchable 5 - 5.2 mm; plain; snap-on type; gray	www.wago.com/2009-145/000-007
	Артикул №: 2009-145/000-012 Mini-WSB Inline; for Smart Printer; 1700 pieces on roll; stretchable 5 - 5.2 mm; plain; snap-on type; orange	www.wago.com/2009-145/000-012
	Артикул №: 2009-145/000-023 Mini-WSB Inline; for Smart Printer; 1700 pieces on roll; stretchable 5 - 5.2 mm; plain; snap-on type; green	www.wago.com/2009-145/000-023
	Артикул №: 2009-145/000-024 Mini-WSB Inline; for Smart Printer; 1700 pieces on roll; stretchable 5 - 5.2 mm; plain; snap-on type; violet	www.wago.com/2009-145/000-024
	Артикул №: 2009-191 Group marker carrier	www.wago.com/2009-191

Подлежи на промяна. Моля, обърнете внимание и на допълнителната документация на продукта!

ВАГО България ООД
Бизнес център Сердика
Бул."Акад. Иван Гешов" 2Е | Сграда 1, ет. 4, офис 417 | 1330 София
Тел.: +359 2 489 46 09 | Тел.: +359 2 489 46 10
Имейл: sales.bg@wago.com













Имате ли въпроси относно нашите продукти?
Винаги ще се радваме да получим вашето обаждане на +359 2 489 46 09.

	Артикул №: 2009-192 Group marker carrier	www.wago.com/2009-192
	Артикул №: 2009-193 Group marker carrier	www.wago.com/2009-193
	Артикул №: 2009-198 Adaptor; gray	www.wago.com/2009-198
	Артикул №: 248-501 Miniature WSB Quick marking system; plain; Marker width 5 mm; 10 strips with 10 markers per card	www.wago.com/248-501
	Артикул №: 248-501/000-002 Mini-WSB marking card; as card; not stretchable; plain; snap-on type; yellow	www.wago.com/248-501/000-002
	Артикул №: 248-501/000-005 Mini-WSB marking card; as card; not stretchable; plain; snap-on type; red	www.wago.com/248-501/000-005
	Артикул №: 248-501/000-006 Mini-WSB marking card; as card; not stretchable; plain; snap-on type; blue	www.wago.com/248-501/000-006
	Артикул №: 248-501/000-007 Mini-WSB marking card; as card; not stretchable; plain; snap-on type; gray	www.wago.com/248-501/000-007
	Артикул №: 248-501/000-012 Mini-WSB marking card; as card; not stretchable; plain; snap-on type; orange	www.wago.com/248-501/000-012
	Артикул №: 248-501/000-017 Mini-WSB marking card; as card; not stretchable; plain; snap-on type; light green	www.wago.com/248-501/000-017
	Артикул №: 248-501/000-023 Mini-WSB marking card; as card; not stretchable; plain; snap-on type; green	www.wago.com/248-501/000-023
	Артикул №: 248-501/000-024 Mini-WSB marking card; as card; not stretchable; plain; snap-on type; violet	www.wago.com/248-501/000-024
	Артикул №: 793-501 WMB marking card; as card; not stretchable; plain; snap-on type; white	www.wago.com/793-501
	Артикул №: 793-501/000-002 WMB marking card; as card; not stretchable; plain; snap-on type; yellow	www.wago.com/793-501/000-002
	Артикул №: 793-501/000-005 WMB marking card; as card; not stretchable; plain; snap-on type; red	www.wago.com/793-501/000-005

Подлежи на промяна. Моля, обърнете внимание и на допълнителната документация на продукта!

ВАГО България ООД
Бизнес център Сердика
Бул."Акад. Иван Гешов" 2Е | Сграда 1, ет. 4, офис 417 | 1330 София
Тел.: +359 2 489 46 09 | Тел.: +359 2 489 46 10
Имейл: sales.bg@wago.com

Имате ли въпроси относно нашите продукти?
Винаги ще се радваме да получим вашето обаждане на +359 2 489 46 09.

	Артикул №: 793-501/000-006 WMB marking card; as card; not stretchable; plain; snap-on type; blue	www.wago.com/793-501/000-006
	Артикул №: 793-501/000-007 WMB marking card; as card; not stretchable; plain; snap-on type; gray	www.wago.com/793-501/000-007
	Артикул №: 793-501/000-012 WMB marking card; as card; not stretchable; plain; snap-on type; orange	www.wago.com/793-501/000-012
	Артикул №: 793-501/000-017 WMB marking card; as card; not stretchable; plain; snap-on type; light green	www.wago.com/793-501/000-017
	Артикул №: 793-501/000-023 WMB marking card; as card; not stretchable; plain; snap-on type; green	www.wago.com/793-501/000-023
	Артикул №: 793-501/000-024 WMB marking card; as card; not stretchable; plain; snap-on type; violet	www.wago.com/793-501/000-024
	Артикул №: 793-5501 WMB marking card; as card; for terminal block width 5 - 17.5 mm; stretchable 5 - 5.2 mm; plain; snap-on type; white	www.wago.com/793-5501
	Артикул №: 793-5501/000-002 WMB marking card; as card; for terminal block width 5 - 17.5 mm; stretchable 5 - 5.2 mm; plain; snap-on type; yellow	www.wago.com/793-5501/000-002
	Артикул №: 793-5501/000-005 WMB marking card; as card; for terminal block width 5 - 17.5 mm; stretchable 5 - 5.2 mm; plain; snap-on type; red	www.wago.com/793-5501/000-005
	Артикул №: 793-5501/000-006 WMB marking card; as card; for terminal block width 5 - 17.5 mm; stretchable 5 - 5.2 mm; plain; snap-on type; blue	www.wago.com/793-5501/000-006
	Артикул №: 793-5501/000-007 WMB marking card; as card; for terminal block width 5 - 17.5 mm; stretchable 5 - 5.2 mm; plain; snap-on type; gray	www.wago.com/793-5501/000-007
	Артикул №: 793-5501/000-012 WMB marking card; as card; for terminal block width 5 - 17.5 mm; stretchable 5 - 5.2 mm; plain; snap-on type; orange	www.wago.com/793-5501/000-012
	Артикул №: 793-5501/000-014 WMB marking card; as card; for terminal block width 5 - 17.5 mm; stretchable 5 - 5.2 mm; plain; snap-on type; brown	www.wago.com/793-5501/000-014
	Артикул №: 793-5501/000-017	

Подлежи на промяна. Моля, обърнете внимание и на допълнителната документация на продукта!

ВАГО България ООД
Бизнес център Сердика
Бул."Акад. Иван Гешов" 2Е | Сграда 1, ет. 4, офис 417 | 1330 София
Тел.: +359 2 489 46 09 | Тел.: +359 2 489 46 10
Имейл: sales.bg@wago.com

Имате ли въпроси относно нашите продукти?
Винаги ще се радваме да получим вашето обаждане на +359 2 489 46 09.



WMB marking card; as card; for terminal block width 5 - 17.5 mm; stretchable 5 - 5.2 mm; plain; snap-on type; green

www.wago.com/793-5501/000-017



Артикул №: 793-5501/000-023

WMB marking card; as card; for terminal block width 5 - 17.5 mm; stretchable 5 - 5.2 mm; plain; snap-on type; light green

www.wago.com/793-5501/000-023



Артикул №: 793-5501/000-024

WMB marking card; as card; for terminal block width 5 - 17.5 mm; stretchable 5 - 5.2 mm; plain; snap-on type; violet

www.wago.com/793-5501/000-024

check



Артикул №: 2002-511

Modular TOPJOB®S connector; modular; for jumper contact slot; 1-pole; 2,50 mm²; gray

www.wago.com/2002-511



Артикул №: 2002-549

Spacer module; modular; e.g., for bridging commoned terminal blocks; gray

www.wago.com/2002-549



Артикул №: 2002-552

Modular TOPJOB®S connector; modular; for jumper contact slot; 2-pole; 2,50 mm²; gray

www.wago.com/2002-552



Артикул №: 2002-553

Modular TOPJOB®S connector; modular; for jumper contact slot; 3-pole; 2,50 mm²; gray

www.wago.com/2002-553



Артикул №: 2002-554

Modular TOPJOB®S connector; modular; for jumper contact slot; 4-pole; 2,50 mm²; gray

www.wago.com/2002-554



Артикул №: 2002-555

Modular TOPJOB®S connector; modular; for jumper contact slot; 5-pole; 2,50 mm²; gray

www.wago.com/2002-555



Артикул №: 2002-556

Modular TOPJOB®S connector; modular; for jumper contact slot; 6-pole; 2,50 mm²; gray

www.wago.com/2002-556



Артикул №: 2002-557

Modular TOPJOB®S connector; modular; for jumper contact slot; 7-pole; 2,50 mm²; gray

www.wago.com/2002-557



Артикул №: 2002-558

Modular TOPJOB®S connector; modular; for jumper contact slot; 8-pole; 2,50 mm²; gray

www.wago.com/2002-558



Артикул №: 2002-559

Modular TOPJOB®S connector; modular; for jumper contact slot; 9-pole; 2,50 mm²; gray

www.wago.com/2002-559



Артикул №: 2002-560

Modular TOPJOB®S connector; modular; for jumper contact slot; 10-pole; 2,50 mm²; gray

www.wago.com/2002-560



Артикул №: 2002-611

TOPJOB®S L-type test plug module; modular; 1-pole; 2,50 mm²; gray

www.wago.com/2002-611



Артикул №: 2002-649

TOPJOB®S L-type spacer module; modular; e.g., for bridging commoned terminal blocks; gray

www.wago.com/2002-649

Артикул №: 2009-174

Test plug adapter; for 4 mm Ø test plugs; for testing TOPJOB®S rail-mounted terminal blocks; gray

www.wago.com/2009-174

Подлежи на промяна. Моля, обърнете внимание и на допълнителната документация на продукта!

ВАГО България ООД

Бизнес център Сердика

Бул."Акад. Иван Гешов" 2Е | Сграда 1, ет. 4, офис 417 | 1330 София

Тел.: +359 2 489 46 09 | Тел.: +359 2 489 46 10

Имейл: sales.bg@wago.com

Имате ли въпроси относно нашите продукти?

Винаги ще се радваме да получим вашето обаждане на +359 2 489 46 09.



	Артикул №: 2009-182 Testing tap; for max. 2.5 mm ² ; tool-free connection for individual test wires 0.08 - 2.5 mm; gray	www.wago.com/2009-182
--	--	--

End plate

Артикул №: 2002-1293 Separator plate; 2 mm thick; oversized; gray	www.wago.com/2002-1293
---	--



Артикул №: 2002-1294 Separator plate; 2 mm thick; oversized; orange	www.wago.com/2002-1294
---	--



Артикул №: 209-190 Separator for Ex e/Ex i applications; 3 mm thick; 90 mm wide; orange	www.wago.com/209-190
---	--



Артикул №: 209-191 Separator for Ex e/Ex i applications; 3 mm thick; 120 mm wide; orange	www.wago.com/209-191
--	--

Insulation stop

Артикул №: 2002-171 Insulation stop; 0.25 - 0.5 mm ² ; 5 pieces/strip; light gray	www.wago.com/2002-171
--	--



Артикул №: 2002-172 Insulation stop; 0.75 - 1 mm ² ; 5 pieces/strip; dark gray	www.wago.com/2002-172
---	--

Изтегляния**Documentation****Bid Text**

2002-1204 docx - Datei	Apr 23, 2019	docx 15,1 kB	Изтегляне
---------------------------	--------------	-----------------	-----------

2002-1204 X81 - Datei	Apr 29, 2019	xml 4,3 kB	Изтегляне
--------------------------	--------------	---------------	-----------

Additional Information

Technical explanations	Apr 3, 2019	pdf 2,2 MB	Изтегляне
------------------------	-------------	---------------	-----------

CAD/CAE-Data**CAD data**

2D/3D Models 2002-1204	URL	Изтегляне
------------------------	-----	-----------

CAE data

Подлежи на промяна. Моля, обърнете внимание и на допълнителната документация на продукта!

ВАГО България ООД
Бизнес център Сердика
Бул."Акад. Иван Гешов" 2Е | Сграда 1, ет. 4, офис 417 | 1330 София
Тел.: +359 2 489 46 09 | Тел.: +359 2 489 46 10
Имейл: sales.bg@wago.com

Имате ли въпроси относно нашите продукти?
Винаги ще се радваме да получим вашето обаждане на +359 2 489 46 09.

EPLAN Data Portal 2002-1204	URL	Изтегляне
WSCAD Universe 2002-1204	URL	Изтегляне
ZUKEN Portal 2002-1204	URL	Изтегляне

Бележки за инсталиране

Conductor termination

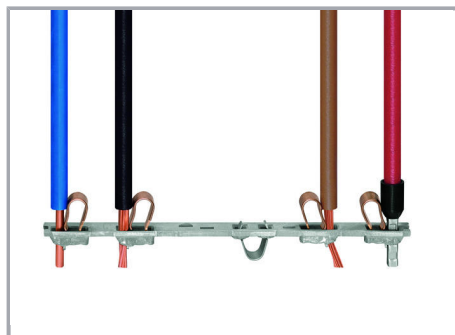

All conductor types at a glance

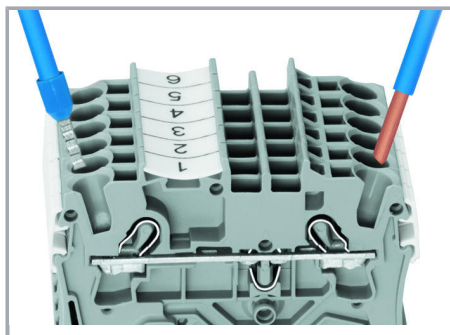

Terminating solid and ferruled conductors via push-in connection.

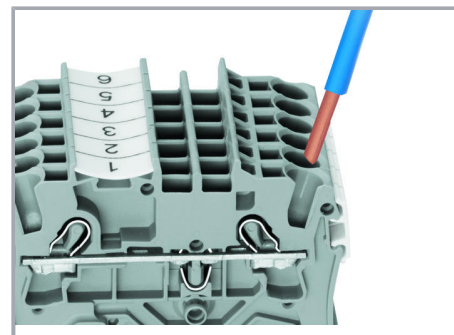

Inserting conductors via push-in termination.

Solid conductors with cross-sections from either one size above, or up to two sizes below, the rated cross-section can be simply pushed in – no tools needed.

Подлежи на промяна. Моля, обърнете внимание и на допълнителната документация на продукта!

ВАГО България ООД
Бизнес център Сердика
Бул."Акад. Иван Гешов" 2Е | Сграда 1, ет. 4, офис 417 | 1330 София
Тел.: +359 2 489 46 09 | Тел.: +359 2 489 46 10
Имейл: sales.bg@wago.com

Имате ли въпроси относно нашите продукти?
Винаги ще се радваме да получим вашето обаждане на +359 2 489 46 09.

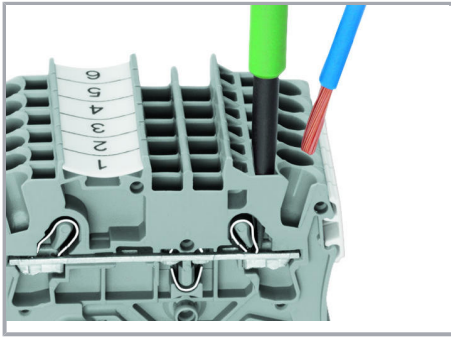

Inserting a conductor via operating tool.

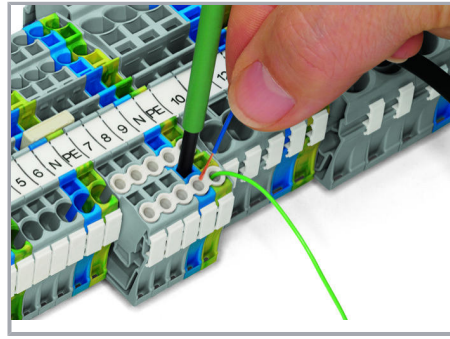

Conductor termination – Insulation stop.

Connecting fine-stranded conductors without ferrules, or small cross-sectional conductors that cannot be pushed in, is performed similarly to the original CAGE CLAMP® – just use an operating tool.

The smart feature:

To open the clamp, the operating tool is inserted vertically. The conductor entry is less than 15 degrees for easier wiring.

Commoning

Подлежи на промяна. Моля, обърнете внимание и на допълнителната документация на продукта!

ВАГО България ООД
Бизнес център Сердика
Бул."Акад. Иван Гешов" 2Е | Сграда 1, ет. 4, офис 417 | 1330 София
Тел.: +359 2 489 46 09 | Тел.: +359 2 489 46 10
Имейл: sales.bg@wago.com

Имате ли въпроси относно нашите продукти?
Винаги ще се радваме да получим вашето обаждане на +359 2 489 46 09.

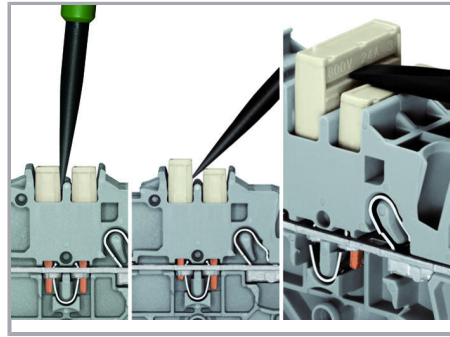
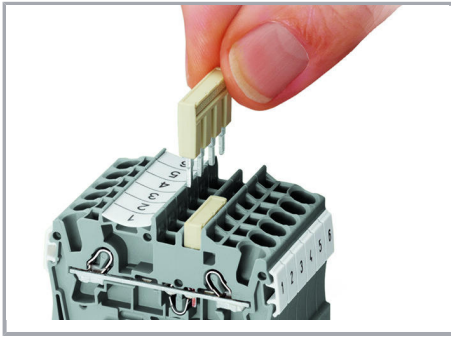

The push-in type jumper bar system is based on the common plug and socket principle. Each terminal block is spring-loaded with a double socket and a resilient CrNi steel spring. The jumper contact material is pure electrolytic copper, which allows for an extremely small design capable of carrying the full-rated current of the terminal block. Ground terminal blocks can also be commoned using the same jumper system. Custom jumpers are created by breaking and removing jumper contacts (2000, 2001, 2002, 2004 Series).

Removing a push-in type jumper bar.

Insert the operating tool between the jumper and the partition wall of the dual jumper slots, then lift up the jumper.

Place the operating tool in the center of jumpers up to five contacts (see above), or alternately on both sides for jumpers with more than five contacts.

Commoning

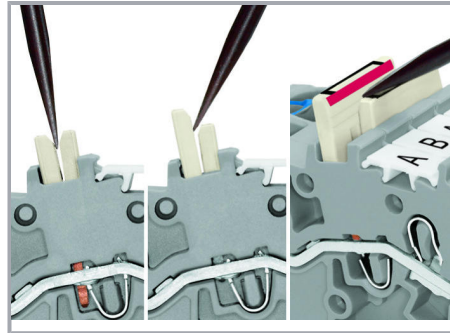
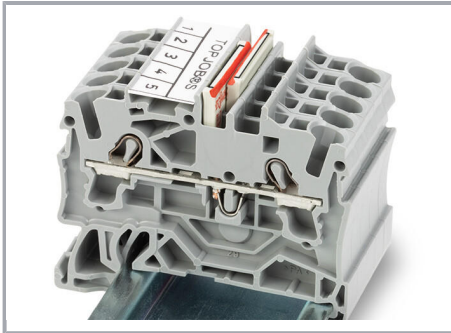

Locate red stripes of the staggered jumpers on the inside.

Removing a staggered jumper:

Insert staggered jumper and push down until it hits backstop.

Insert the operating tool between the staggered jumpers, then lift up the jumper.

Commoning

Подлежи на промяна. Моля, обърнете внимание и на допълнителната документация на продукта!

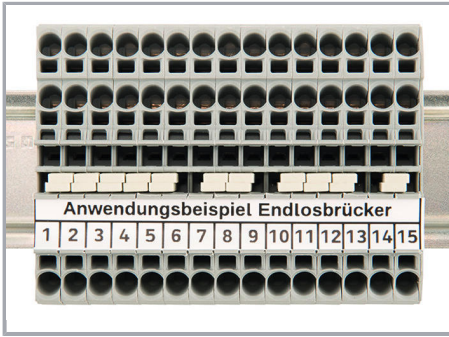

Continuous jumpers (2002 Series) readily connect an endless number of terminal blocks to each other via a single jumper slot. Use the second jumper slot for additional commoning or testing.

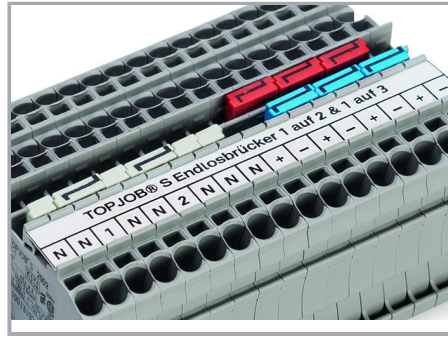

The 1-to-3 adjacent jumper for continuous commoning enables every other terminal block to be commoned. For example, positive and negative potentials can be accommodated alongside each other.

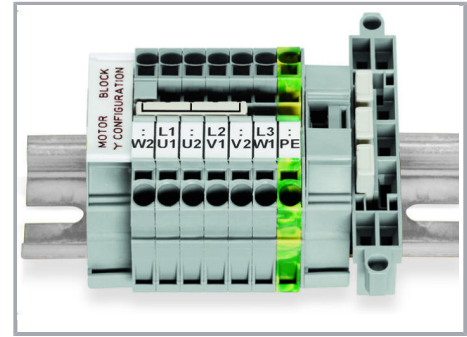

This star point jumper has been specially developed to create a "star point" and is used on motor terminal boards equipped with TOPJOB® S rail-mount terminal blocks.

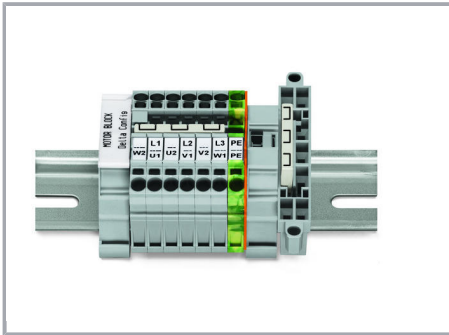

This delta jumper has been specially developed to create a delta configuration and is used on motor terminal boards equipped with TOPJOB® S rail-mount terminal blocks.

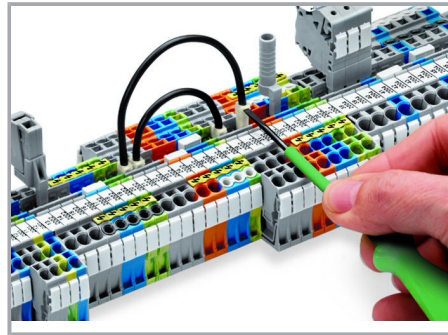

Push down the wire jumper until fully inserted. Lift the jumper with an operating tool for rewiring.

Commoning

Подлежи на промяна. Моля, обърнете внимание и на допълнителната документация на продукта!

ВАГО България ООД
 Бизнес център Сердика
 Бул."Акад. Иван Гешов" 2Е | Сграда 1, ет. 4, офис 417 | 1330 София
 Тел.: +359 2 489 46 09 | Тел.: +359 2 489 46 10
 Имейл: sales.bg@wago.com

Имате ли въпроси относно нашите продукти?
 Винаги ще се радваме да получим вашето обаждане на +359 2 489 46 09.

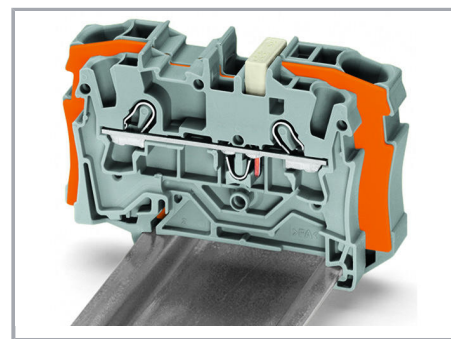
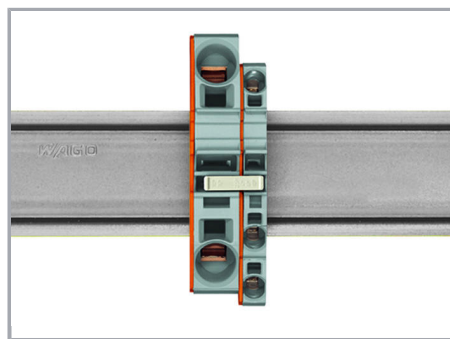
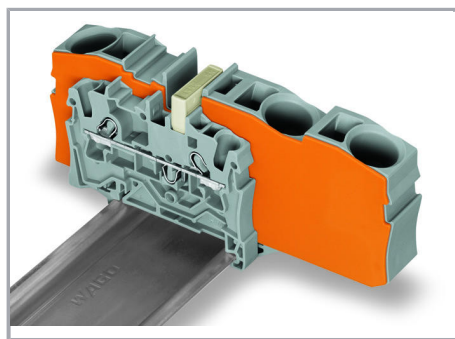

Step-down jumpers may common terminal blocks of different sizes, without losing a conductor clamping point. This can be beneficial on long conductor runs where voltage drops may be problematic. A large conductor can be easily connected to smaller conductors at the distribution point.

Using step-down jumpers, an end plate must be inserted between the terminal blocks to be commoned.

Step-down jumper (2006-499) commons 6 /4 mm² (10/12 AWG) terminal blocks (2006 /2004 Series) with 4/2.5/1.5 mm² (12/14/16 AWG) terminal blocks (2004/2002/2001 Series).

Commoning may be made in either direction using the special thin end plate to cover the open side. Additional through terminal blocks having a smaller cross-section may be commoned using push-in type jumper bars.

Подлежи на промяна. Моля, обърнете внимание и на допълнителната документация на продукта!

ВАГО България ООД
Бизнес център Сердика
Бул."Акад. Иван Гешов" 2Е | Сграда 1, ет. 4, офис 417 | 1330 София
Тел.: +359 2 489 46 09 | Тел.: +359 2 489 46 10
Имейл: sales.bg@wago.com

Имате ли въпроси относно нашите продукти?
Винаги ще се радваме да получим вашето обаждане на +359 2 489 46 09.

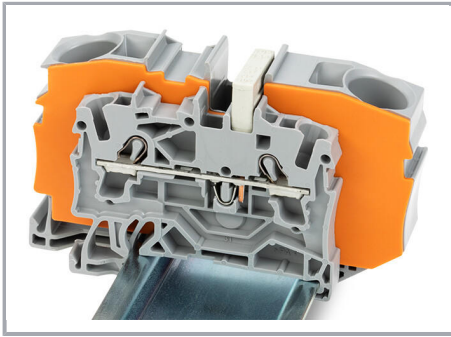

Step-down jumper (2016-499) commons 16 /10 mm² (16/8 AWG) terminal blocks (2016 /2010 Series) with 10/6/4/2.5 mm² (8/10/12 /14 AWG) terminal blocks (2010/2006/2004 /2002 Series).

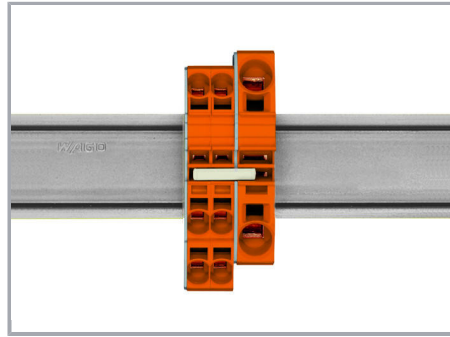

Stepping down via push-in type jumper bar.

Commoning via open terminal side with end plate allows jumpering over two cross-section sizes for 16 mm² (6 AWG) and 10 mm² (8 AWG) and one cross-section size for 6/4/2.5 mm² (10/12/14 AWG). An example: from 16 mm² (6 AWG) to 6 mm² (10 AWG) (see illustration above) or from 10 mm² (8 AWG) to 4 mm² (12 AWG).

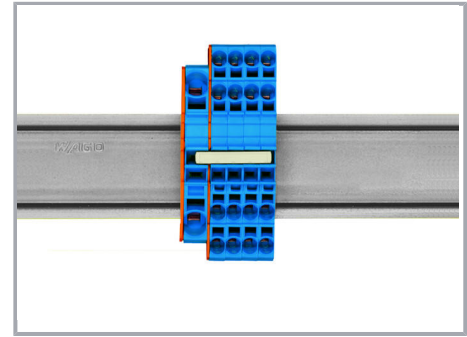

Stepping down via push-in type jumper bar.

Commoning via closed terminal side with end plate allows jumpering over two cross-section sizes, e.g., from 16 mm² (6 AWG) to 6 mm² (10 AWG) or from 6 mm² (10 AWG) to 2.5 mm² (14 AWG) (see illustration above).

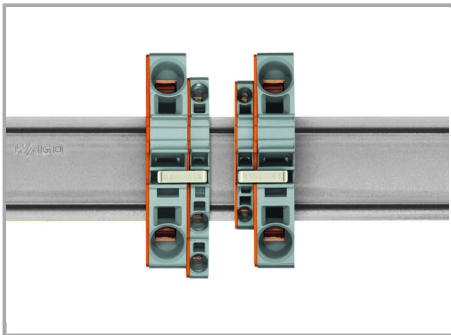

Note:

The total current of the outgoing circuits shall not exceed the nominal current of the step-down jumper/push-in type jumper bar.

Testing

Подлежи на промяна. Моля, обърнете внимание и на допълнителната документация на продукта!

ВАГО България ООД
Бизнес център Сердика
Бул."Акад. Иван Гешов" 2Е | Сграда 1, ет. 4, офис 417 | 1330 София
Тел.: +359 2 489 46 09 | Тел.: +359 2 489 46 10
Имейл: sales.bg@wago.com

Имате ли въпроси относно нашите продукти?
Винаги ще се радваме да получим вашето обаждане на +359 2 489 46 09.

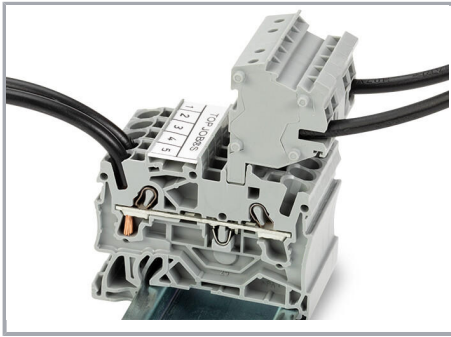

The modular TOPJOB® S connectors also connect conductors of the same size as the terminal blocks being used.

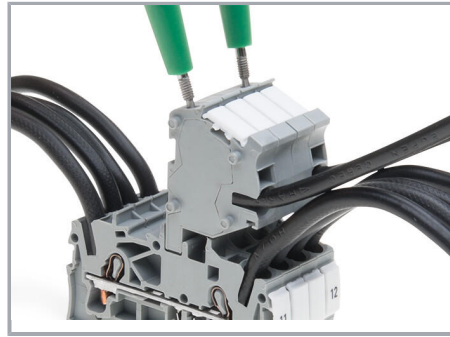

TOPJOB® S Connectors with a 2 mm Ø test socket for testing voltage via 2-pole voltage tester

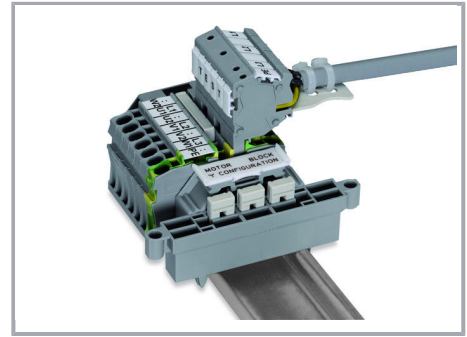

Rail-mount terminal block assembly for electric motor wiring

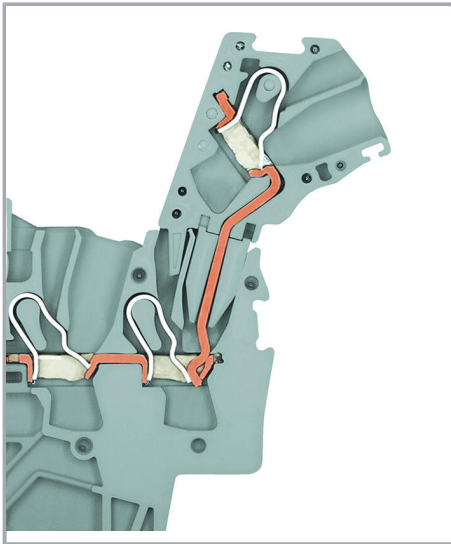

L-type test plug module – cross-sectional view of contacts

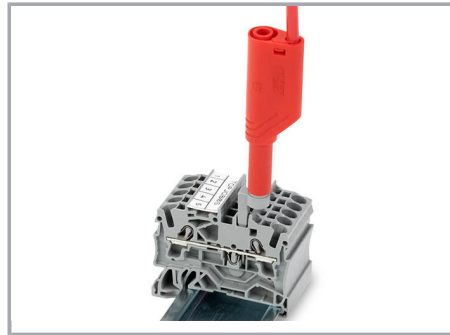

Test plug adapter (2009-174, CAT I) for 4 mm Ø plugs – compatible with 2000 to 2016 Series

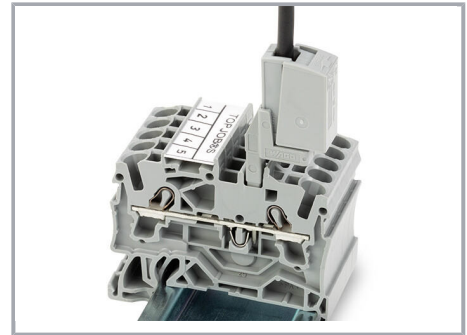

Testing tap (2009-182) for tool-free connection of test cables up to 2.5 mm² (12 AWG) – compatible with 2000 to 2016 Series

Marking

Подлежи на промяна. Моля, обърнете внимание и на допълнителната документация на продукта!

ВАГО България ООД
Бизнес център Сердика
Бул."Акад. Иван Гешов" 2Е | Сграда 1, ет. 4, офис 417 | 1330 София
Тел.: +359 2 489 46 09 | Тел.: +359 2 489 46 10
Имейл: sales.bg@wago.com

Имате ли въпроси относно нашите продукти?
Винаги ще се радваме да получим вашето обаждане на +359 2 489 46 09.

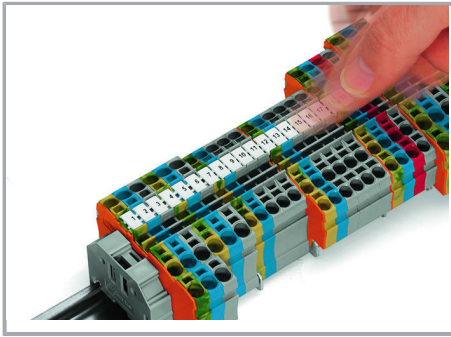

Snapping WMB Inline markers into marker slots.

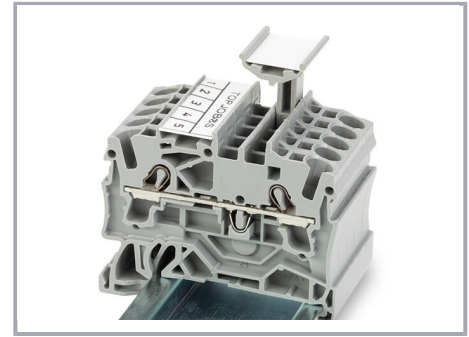
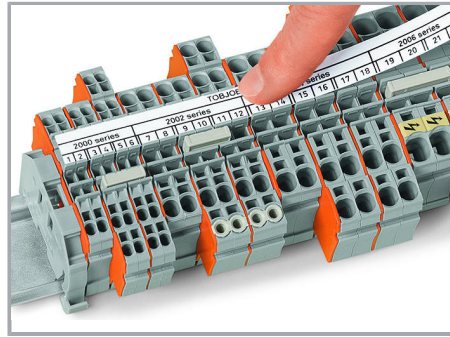

TOPJOB® S 2009-193 Group Marker Carrier (equipped with a marking strip) for all 2001 to 2016 Series TOPJOB® S Rail-Mount Terminal Blocks

Do not use on an end plate!

Подлежи на промяна. Моля, обърнете внимание и на допълнителната документация на продукта!

ВАГО България ООД
Бизнес център Сердика
Бул."Акад. Иван Гешов" 2Е | Сграда 1, ет. 4, офис 417 | 1330 София
Тел.: +359 2 489 46 09 | Тел.: +359 2 489 46 10
Имейл: sales.bg@wago.com

Имате ли въпроси относно нашите продукти?
Винаги ще се радваме да получим вашето обаждане на +359 2 489 46 09.

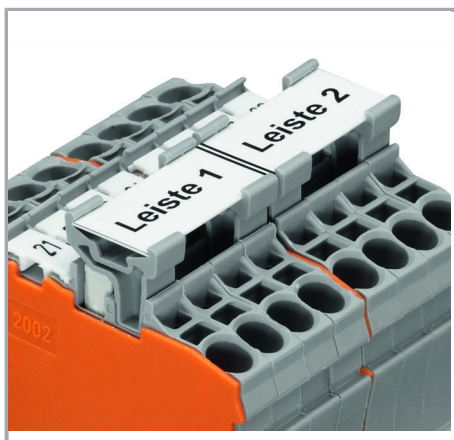

Using marker carriers for marking strips (2002-161) in jumper slots.

Ex application

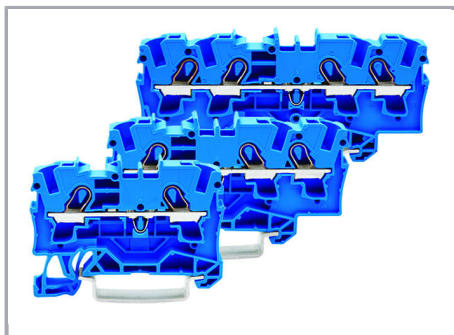

Through terminal blocks with a blue insulated housing are suitable for Ex i applications.



All through and ground conductor terminal blocks are suitable for Ex e II applications.

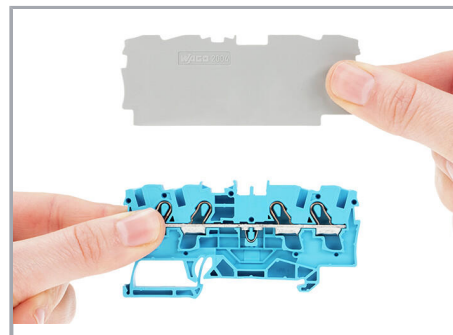

Separator for Ex e/Ex i applications

An end plate must be applied to the terminal block located directly behind an Ex e/Ex i separator plate.

Подлежи на промяна. Моля, обърнете внимание и на допълнителната документация на продукта!

ВАГО България ООД
Бизнес център Сердика
Бул."Акад. Иван Гешов" 2Е | Сграда 1, ет. 4, офис 417 | 1330 София
Тел.: +359 2 489 46 09 | Тел.: +359 2 489 46 10
Имейл: sales.bg@wago.com

Имате ли въпроси относно нашите продукти?
Винаги ще се радваме да получим вашето обаждане на +359 2 489 46 09.

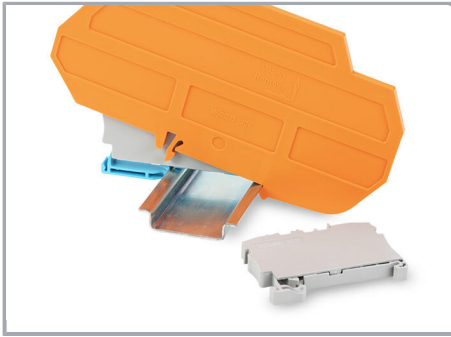

Ex e II/Ex i terminal strip

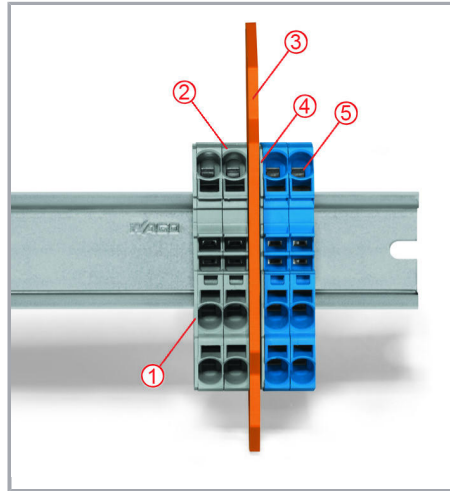

Notice:

The movable feet of terminal blocks and separator plates must face the same direction.

Separator located between Ex e II and Ex i terminal strip

End plate

Ex e II terminal blocks

Separator for Ex e/Ex i applications

End plate

Ex i terminal blocks

According to EN 50020, a minimum distance of 50 mm must be kept between live parts of Ex e and Ex i circuits. The use of Ex e/Ex i separators is a space-saving solution when Ex e and Ex i terminal blocks are mounted on a common carrier rail.

Семейство продукти

TOPJOB® S

Подлежи на промяна. Моля, обърнете внимание и на допълнителната документация на продукта!

ВАГО България ООД
Бизнес център Сердика
Бул."Акад. Иван Гешов" 2Е | Сграда 1, ет. 4, офис 417 | 1330 София
Тел.: +359 2 489 46 09 | Тел.: +359 2 489 46 10
Имейл: sales.bg@wago.com

Имате ли въпроси относно нашите продукти?
Винаги ще се радваме да получим вашето обаждане на +359 2 489 46 09.



TOPJOB® S: In various industrial applications and modern building installations, WAGO's wide and versatile range of rail-mount terminal blocks provides more than just reliable electrical connections.

Показване на всички продукти от семейството.

Подлежи на промяна. Моля, обърнете внимание и на допълнителната документация на продукта!

ВАГО България ООД
Бизнес център Сердика
Бул."Акад. Иван Гешов" 2Е | Сграда 1, ет. 4, офис 417 | 1330 София
Тел.: +359 2 489 46 09 | Тел.: +359 2 489 46 10
Имейл: sales.bg@wago.com

Имате ли въпроси относно нашите продукти?
Винаги ще се радваме да получим вашето обаждане на +359 2 489 46 09.