

Информационен лист | Номер на артикул: 2002-1201

2-conductor through terminal block; 2.5 mm²; suitable for Ex e II applications; side and center marking; for DIN-rail 35 x 15 and 35 x 7.5; Push-in CAGE CLAMP®; 2,50 mm²; gray

www.wago.com/2002-1201

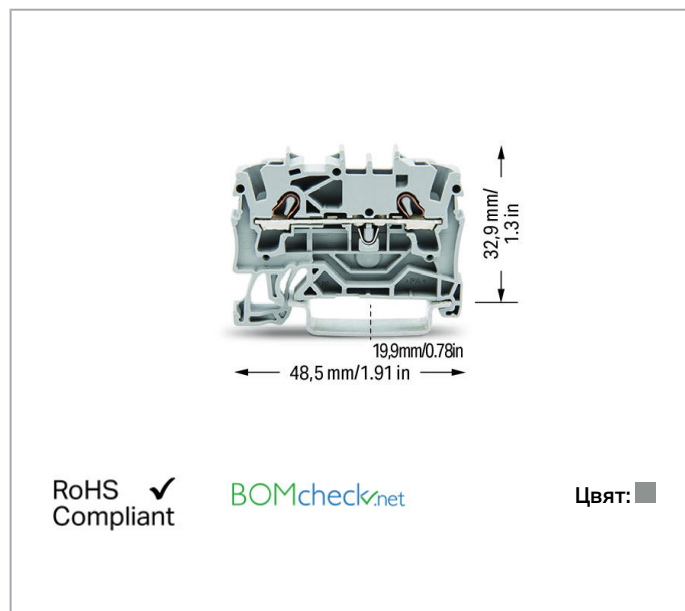

Данни

Electrical data

Ratings per IEC/EN 60664-1

Ratings per	IEC/EN 60947-7-1
Nominal voltage (III/3)	800 V
Rated surge voltage (III/3)	8 kV
Rated current	24 A
Rated current 2	32 A
Legend (ratings)	(III / 3) ≙ Overvoltage category III / Pollution degree 3

Ratings per UL 1059

Approvals per	UL 1059
Rated voltage UL (Use Group B)	600 V
Rated current UL (Use Group B)	20 A
Rated voltage UL (Use Group C)	600 V
Rated current UL (Use Group C)	20 A

Подлежи на промяна. Моля, обърнете внимание и на допълнителната документация на продукта!

ВАГО България ООД
Бизнес център Сердика
Бул."Акад. Иван Гешов" 2Е | Сграда 1, ет. 4, офис 417 | 1330 София
Тел.: +359 2 489 46 09 | Тел.: +359 2 489 46 10
Имейл: sales.bg@wago.com

Имате ли въпроси относно нашите продукти?
Винаги ще се радваме да получим вашето обаждане на +359 2 489 46 09.



Ratings per CSA

Rated voltage CSA (Use Group B)	600 V
Rated current CSA (Use Group B)	20 A
Rated voltage CSA (Use Group C)	600 V
Rated current CSA (Use Group C)	20 A

Ex information

Rated voltage EN (Ex e II)	550 V
Rated current (Ex e II)	22 A
Rated current (Ex e II) with jumper	20 A

Connection data

Connection technology	Push-in CAGE CLAMP®
Actuation type	Push-in Operating tool
Connectable conductor materials	Copper
Nominal cross-section	2,5 mm ²
Solid conductor	0,25 ... 4 mm ² / 22 ... 12 AWG
Solid conductor; push-in termination	1 ... 4 mm ² / 18 ... 12 AWG
Fine-stranded conductor	0,25 ... 4 mm ² / 22 ... 12 AWG
Fine-stranded conductor; with insulated ferrule	1 ... 2,5 mm ² / 18 ... 14 AWG
Fine-stranded conductor; with ferrule; push-in termination	1 ... 2,5 mm ² / 18 ... 14 AWG
Note (conductor cross-section)	Depending on the conductor characteristic, a conductor with a smaller cross-section can also be inserted via push-in termination.
Strip length	10 ... 12 mm / 0.39 ... 0.47 inch
Total number of connection points	2
Total number of potentials	1
Number of levels	1
Wiring type	Front-entry wiring
Number of jumper slots	2

Physical data

Width	5,2 mm / 0.205 inch
Height from upper-edge of DIN-rail	32,9 mm / 1.295 inch
Depth	48,5 mm / 1.909 inch

Подлежи на промяна. Моля, обърнете внимание и на допълнителната документация на продукта!

ВАГО България ООД
 Бизнес център Сердика
 Бул."Акад. Иван Гешов" 2Е | Сграда 1, ет. 4, офис 417 | 1330 София
 Тел.: +359 2 489 46 09 | Тел.: +359 2 489 46 10
 Имейл: sales.bg@wago.com

Имате ли въпроси относно нашите продукти?
 Винаги ще се радваме да получим вашето обаждане на +359 2 489 46 09.

Mechanical data

Design	horizontal type
Mounting type	DIN-35 rail
Marking level	Center/side marking

Material Data





Color	gray
Insulation material	Polyamide (PA66)
Fire load	0,109 MJ
Weight	5,1 g

Commercial data

Product Group	22 (TOPJOB S)
Packaging type	BOX
Country of origin	DE
GTIN	4017332999168
Customs tariff number	85369010000

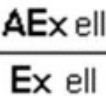
Одобрения / Сертификати

Ex-Approvals

Лого	Одобрение	Допълнителен текст за одобрение	Име на сертификат
 AEx ell Ex ell	AEx Underwriters Laboratories Inc.	UL 60079	20190704-E185892
	ATEX Physikalisch Technische Bundesanstalt (PTB)	EN 60079	PTB 03 ATEX 1162 U (II 2 G/D Ex e II bzw. I M 2 Ex e I)
 Ex e IIC Gb Ex e I Mb	CCCEX CQST/CNEX	CNCA-C23-01	2020312313000238
	IECEX Physikalisch Technische Bundesanstalt	IEC 60079	IECEX PTB 03.0004 U (Ex eb IIC Gb or Ex eb I Mb)

Country specific Approvals

Подлежи на промяна. Моля, обърнете внимание и на допълнителната документация на продукта!

ВАГО България ООД
 Бизнес център Сердика
 Бул."Акад. Иван Гешов" 2Е | Сграда 1, ет. 4, офис 417 | 1330 София
 Тел.: +359 2 489 46 09 | Тел.: +359 2 489 46 10
 Имейл: sales.bg@wago.com

Имате ли въпроси относно нашите продукти?
 Винаги ще се радваме да получим вашето обаждане на +359 2 489 46 09.

Лого	Одобрение	Допълнителен текст за одобрение	Име на сертификат
	CCA DEKRA Certification B.V.	EN 60947	NTR NL 7730
	CSA DEKRA Certification B.V.	C22.2 No. 158	1536069
	EAC Brjansker Zertifizierungsstelle	TP TC 012/2011	RU C-DE. AM02.B. 00127/19
	KEMA/KEUR DEKRA Certification B.V.	EN 60947	71-107687

Ship Approvals

Лого	Одобрение	Допълнителен текст за одобрение	Име на сертификат
	ABS American Bureau of Shipping	EN 60947	20- HG1941090- PDA
	BV Bureau Veritas S.A.	EN 60947	38586/A0 BV
	DNV GL Det Norske Veritas, Germanischer Lloyd	-	TAE00001V2
	LR Lloyds Register	EN 60947	91/20112 (E9)

UL-Approvals

Лого	Одобрение	Допълнителен текст за одобрение	Име на сертификат
	cURus Underwriters Laboratories Inc.	UL 1059	20190731- E45172

Подлежи на промяна. Моля, обърнете внимание и на допълнителната документация на продукта!



ВАГО България ООД
Бизнес център Сердика
Бул."Акад. Иван Гешов" 2Е | Сграда 1, ет. 4, офис 417 | 1330 София
Тел.: +359 2 489 46 09 | Тел.: +359 2 489 46 10
Имейл: sales.bg@wago.com

Имате ли въпроси относно нашите продукти?
Винаги ще се радваме да получим вашето обаждане на +359 2 489 46 09.







Изискват се аксесоари

End plate



	Артикул №: 2002-1291 End and intermediate plate; 0.8 mm thick; gray	www.wago.com/2002-1291
	Артикул №: 2002-1292 End and intermediate plate; 0.8 mm thick; orange	www.wago.com/2002-1292

Съвместими продукти



Push-In type wire jumper

	Артикул №: 2009-412 Push-in type wire jumper; insulated; 60 mm long; black	www.wago.com/2009-412
	Артикул №: 2009-414 Push-in type wire jumper; 1.5 mm ² ; insulated; 110 mm long; black	www.wago.com/2009-414
	Артикул №: 2009-414/000-005 Push-in type wire jumper; 1.5 mm ² ; insulated; 110 mm long; black	www.wago.com/2009-414/000-005
	Артикул №: 2009-414/000-006 Push-in type wire jumper; insulated; 110 mm long; black	www.wago.com/2009-414/000-006
	Артикул №: 2009-416 Push-in type wire jumper; 1.5 mm ² ; insulated; 250 mm long; black	www.wago.com/2009-416

Insulation stop

	Артикул №: 2002-171 Insulation stop; 0.25 - 0.5 mm ² ; 5 pieces/strip; light gray	www.wago.com/2002-171
	Артикул №: 2002-172 Insulation stop; 0.75 - 1 mm ² ; 5 pieces/strip; dark gray	www.wago.com/2002-172

plug

	Артикул №: 2002-880 Empty component plug housing; 10.4 mm wide; 2-pole; Type 4; gray	www.wago.com/2002-880
	Артикул №: 2002-880/1000-411 Component plug; 2-pole; with diode 1N4007; 10.4 mm wide; Operating temperature 85°C max.; gray	www.wago.com/2002-880/1000-411

Подлежи на промяна. Моля, обърнете внимание и на допълнителната документация на продукта!

ВАГО България ООД
Бизнес център Сердика
Бул."Акад. Иван Гешов" 2Е | Сграда 1, ет. 4, офис 417 | 1330 София
Тел.: +359 2 489 46 09 | Тел.: +359 2 489 46 10
Имейл: sales.bg@wago.com

Имате ли въпроси относно нашите продукти?
Винаги ще се радваме да получим вашето обаждане на +359 2 489 46 09.



Артикул №: 2002-880/1000-541
Component plug; 2-pole; LED (red); 10.4 mm wide; Operating temperature 85°C max.; gray

www.wago.com/2002-880/1000-541



Артикул №: 2002-880/1000-542
Component plug; 2-pole; LED (red); 10.4 mm wide; Operating temperature 85°C max.; multicoloured

www.wago.com/2002-880/1000-542



Артикул №: 2002-880/1000-836
Component plug; 2-pole; LED (red); 10.4 mm wide; Operating temperature 85°C max.; gray

www.wago.com/2002-880/1000-836

ferrule



Артикул №: 216-241
Ferrule; Sleeve for 0.5 mm² / 20 AWG; insulated; electro-tin plated; electrolytic copper; gastight crimped; acc. to DIN 46228, Part 4/09.90; white

www.wago.com/216-241



Артикул №: 216-242
Ferrule; Sleeve for 0.75 mm² / 18 AWG; insulated; electro-tin plated; electrolytic copper; gastight crimped; acc. to DIN 46228, Part 4/09.90; gray

www.wago.com/216-242



Артикул №: 216-243
Ferrule; Sleeve for 1 mm² / AWG 18; insulated; electro-tin plated; electrolytic copper; gastight crimped; acc. to DIN 46228, Part 4/09.90; red

www.wago.com/216-243



Артикул №: 216-244
Ferrule; Sleeve for 1.5 mm² / AWG 16; insulated; electro-tin plated; electrolytic copper; gastight crimped; acc. to DIN 46228, Part 4/09.90; black

www.wago.com/216-244



Артикул №: 216-246
Ferrule; Sleeve for 2.5 mm² / AWG 14; insulated; electro-tin plated; electrolytic copper; gastight crimped; acc. to DIN 46228, Part 4/09.90; blue

www.wago.com/216-246



Артикул №: 216-262
Ferrule; Sleeve for 0.75 mm² / 18 AWG; insulated; electro-tin plated; electrolytic copper; gastight crimped; acc. to DIN 46228, Part 4/09.90; gray

www.wago.com/216-262



Артикул №: 216-263
Ferrule; Sleeve for 1 mm² / AWG 18; insulated; electro-tin plated; electrolytic copper; gastight crimped; acc. to DIN 46228, Part 4/09.90; red

www.wago.com/216-263



Артикул №: 216-264
Ferrule; Sleeve for 1.5 mm² / AWG 16; insulated; electro-tin plated; electrolytic copper; gastight crimped; acc. to DIN 46228, Part 4/09.90; black

www.wago.com/216-264



Артикул №: 216-266
Ferrule; Sleeve for 2.5 mm² / AWG 14; insulated; electro-tin plated; electrolytic copper; gastight crimped; acc. to DIN 46228, Part 4/09.90; blue

www.wago.com/216-266

Marking accessories



Артикул №: 2002-161
Adaptor; gray

www.wago.com/2002-161



Артикул №: 2009-110
Marking strips; for Smart Printer; on reel; not stretchable; plain; snap-on type; white

www.wago.com/2009-110

















Артикул №: 2009-115
WMB-Inline; for Smart Printer; 1500 pieces on roll; stretchable 5 - 5.2 mm; plain; snap-on type; white

www.wago.com/2009-115

Подлежи на промяна. Моля, обърнете внимание и на допълнителната документация на продукта!

ВАГО България ООД
Бизнес център Сердика
Бул."Акад. Иван Гешов" 2Е | Сграда 1, ет. 4, офис 417 | 1330 София
Тел.: +359 2 489 46 09 | Тел.: +359 2 489 46 10
Имейл: sales.bg@wago.com















Имате ли въпроси относно нашите продукти?
Винаги ще се радваме да получим вашето обаждане на +359 2 489 46 09.

	Артикул №: 2009-115/000-002 WMB-Inline; for Smart Printer; 1500 pieces on roll; stretchable 5 - 5.2 mm; plain; snap-on type; yellow	www.wago.com/2009-115/000-002
	Артикул №: 2009-115/000-005 WMB-Inline; for Smart Printer; 1500 pieces on roll; stretchable 5 - 5.2 mm; plain; snap-on type; red	www.wago.com/2009-115/000-005
	Артикул №: 2009-115/000-006 WMB-Inline; for Smart Printer; 1500 pieces on roll; stretchable 5 - 5.2 mm; plain; snap-on type; blue	www.wago.com/2009-115/000-006
	Артикул №: 2009-115/000-007 WMB-Inline; for Smart Printer; 1500 pieces on roll; stretchable 5 - 5.2 mm; plain; snap-on type; gray	www.wago.com/2009-115/000-007
	Артикул №: 2009-115/000-012 WMB-Inline; for Smart Printer; 1500 pieces on roll; stretchable 5 - 5.2 mm; plain; snap-on type; orange	www.wago.com/2009-115/000-012
	Артикул №: 2009-115/000-017 WMB-Inline; for Smart Printer; 1500 pieces on roll; stretchable 5 - 5.2 mm; plain; snap-on type; light green	www.wago.com/2009-115/000-017
	Артикул №: 2009-115/000-023 WMB-Inline; for Smart Printer; 1500 pieces on roll; stretchable 5 - 5.2 mm; plain; snap-on type; green	www.wago.com/2009-115/000-023
	Артикул №: 2009-115/000-024 WMB-Inline; for Smart Printer; 1500 pieces on roll; stretchable 5 - 5.2 mm; plain; snap-on type; violet	www.wago.com/2009-115/000-024
	Артикул №: 2009-145 Mini-WSB Inline; for Smart Printer; 1700 pieces on roll; stretchable 5 - 5.2 mm; plain; snap-on type; white	www.wago.com/2009-145
	Артикул №: 2009-145/000-002 Mini-WSB Inline; for Smart Printer; 1700 pieces on roll; stretchable 5 - 5.2 mm; plain; snap-on type; yellow	www.wago.com/2009-145/000-002
	Артикул №: 2009-145/000-005 Mini-WSB Inline; for Smart Printer; 1700 pieces on roll; stretchable 5 - 5.2 mm; plain; snap-on type; red	www.wago.com/2009-145/000-005
	Артикул №: 2009-145/000-006 Mini-WSB Inline; for Smart Printer; 1700 pieces on roll; stretchable 5 - 5.2 mm; plain; snap-on type; blue	www.wago.com/2009-145/000-006
	Артикул №: 2009-145/000-007 Mini-WSB Inline; for Smart Printer; 1700 pieces on roll; stretchable 5 - 5.2 mm; plain; snap-on type; gray	www.wago.com/2009-145/000-007
	Артикул №: 2009-145/000-012 Mini-WSB Inline; for Smart Printer; 1700 pieces on roll; stretchable 5 - 5.2 mm; plain; snap-on type; orange	www.wago.com/2009-145/000-012

Подлежи на промяна. Моля, обърнете внимание и на допълнителната документация на продукта!

ВАГО България ООД
Бизнес център Сердика
Бул."Акад. Иван Гешов" 2Е | Сграда 1, ет. 4, офис 417 | 1330 София
Тел.: +359 2 489 46 09 | Тел.: +359 2 489 46 10
Имейл: sales.bg@wago.com

Имате ли въпроси относно нашите продукти?
Винаги ще се радваме да получим вашето обаждане на +359 2 489 46 09.

	Артикул №: 2009-145/000-023 Mini-WSB Inline; for Smart Printer; 1700 pieces on roll; stretchable 5 - 5.2 mm; plain; snap-on type; green	www.wago.com/2009-145/000-023
	Артикул №: 2009-145/000-024 Mini-WSB Inline; for Smart Printer; 1700 pieces on roll; stretchable 5 - 5.2 mm; plain; snap-on type; violet	www.wago.com/2009-145/000-024
	Артикул №: 2009-191 Group marker carrier	www.wago.com/2009-191
	Артикул №: 2009-192 Group marker carrier	www.wago.com/2009-192
	Артикул №: 2009-193 Group marker carrier	www.wago.com/2009-193
	Артикул №: 2009-198 Adaptor; gray	www.wago.com/2009-198
	Артикул №: 248-501 Miniature WSB Quick marking system; plain; Marker width 5 mm; 10 strips with 10 markers per card	www.wago.com/248-501
	Артикул №: 248-501/000-002 Mini-WSB marking card; as card; not stretchable; plain; snap-on type; yellow	www.wago.com/248-501/000-002
	Артикул №: 248-501/000-005 Mini-WSB marking card; as card; not stretchable; plain; snap-on type; red	www.wago.com/248-501/000-005
	Артикул №: 248-501/000-006 Mini-WSB marking card; as card; not stretchable; plain; snap-on type; blue	www.wago.com/248-501/000-006
	Артикул №: 248-501/000-007 Mini-WSB marking card; as card; not stretchable; plain; snap-on type; gray	www.wago.com/248-501/000-007
	Артикул №: 248-501/000-012 Mini-WSB marking card; as card; not stretchable; plain; snap-on type; orange	www.wago.com/248-501/000-012
	Артикул №: 248-501/000-017 Mini-WSB marking card; as card; not stretchable; plain; snap-on type; light green	www.wago.com/248-501/000-017
	Артикул №: 248-501/000-023 Mini-WSB marking card; as card; not stretchable; plain; snap-on type; green	www.wago.com/248-501/000-023
	Артикул №: 248-501/000-024 Mini-WSB marking card; as card; not stretchable; plain; snap-on type; violet	www.wago.com/248-501/000-024

Подлежи на промяна. Моля, обърнете внимание и на допълнителната документация на продукта!

ВАГО България ООД
Бизнес център Сердика
Бул."Акад. Иван Гешов" 2Е | Сграда 1, ет. 4, офис 417 | 1330 София
Тел.: +359 2 489 46 09 | Тел.: +359 2 489 46 10
Имейл: sales.bg@wago.com

Имате ли въпроси относно нашите продукти?
Винаги ще се радваме да получим вашето обаждане на +359 2 489 46 09.

**Артикул №: 793-501**

WMB marking card; as card; not stretchable; plain; snap-on type; white

www.wago.com/793-501**Артикул №: 793-501/000-002**

WMB marking card; as card; not stretchable; plain; snap-on type; yellow

www.wago.com/793-501/000-002**Артикул №: 793-501/000-005**

WMB marking card; as card; not stretchable; plain; snap-on type; red

www.wago.com/793-501/000-005**Артикул №: 793-501/000-006**

WMB marking card; as card; not stretchable; plain; snap-on type; blue

www.wago.com/793-501/000-006**Артикул №: 793-501/000-007**

WMB marking card; as card; not stretchable; plain; snap-on type; gray

www.wago.com/793-501/000-007**Артикул №: 793-501/000-012**

WMB marking card; as card; not stretchable; plain; snap-on type; orange

www.wago.com/793-501/000-012**Артикул №: 793-501/000-017**

WMB marking card; as card; not stretchable; plain; snap-on type; light green

www.wago.com/793-501/000-017**Артикул №: 793-501/000-023**

WMB marking card; as card; not stretchable; plain; snap-on type; green

www.wago.com/793-501/000-023**Артикул №: 793-501/000-024**

WMB marking card; as card; not stretchable; plain; snap-on type; violet

www.wago.com/793-501/000-024**Артикул №: 793-5501**

WMB marking card; as card; for terminal block width 5 - 17.5 mm; stretchable 5 - 5.2 mm; plain; snap-on type; white

www.wago.com/793-5501**Артикул №: 793-5501/000-002**

WMB marking card; as card; for terminal block width 5 - 17.5 mm; stretchable 5 - 5.2 mm; plain; snap-on type; yellow

www.wago.com/793-5501/000-002**Артикул №: 793-5501/000-005**

WMB marking card; as card; for terminal block width 5 - 17.5 mm; stretchable 5 - 5.2 mm; plain; snap-on type; red

www.wago.com/793-5501/000-005**Артикул №: 793-5501/000-006**

WMB marking card; as card; for terminal block width 5 - 17.5 mm; stretchable 5 - 5.2 mm; plain; snap-on type; blue

www.wago.com/793-5501/000-006

Подлежи на промяна. Моля, обърнете внимание и на допълнителната документация на продукта!

ВАГО България ООД
 Бизнес център Сердика
 Бул."Акад. Иван Гешов" 2Е | Сграда 1, ет. 4, офис 417 | 1330 София
 Тел.: +359 2 489 46 09 | Тел.: +359 2 489 46 10
 Имейл: sales.bg@wago.com

Имате ли въпроси относно нашите продукти?
 Винаги ще се радваме да получим вашето обаждане на +359 2 489 46 09.

**Артикул №: 793-5501/000-007**

WMB marking card; as card; for terminal block width 5 - 17.5 mm; stretchable 5 - 5.2 mm; plain; snap-on type; gray

www.wago.com/793-5501/000-007**Артикул №: 793-5501/000-012**

WMB marking card; as card; for terminal block width 5 - 17.5 mm; stretchable 5 - 5.2 mm; plain; snap-on type; orange

www.wago.com/793-5501/000-012**Артикул №: 793-5501/000-014**

WMB marking card; as card; for terminal block width 5 - 17.5 mm; stretchable 5 - 5.2 mm; plain; snap-on type; brown

www.wago.com/793-5501/000-014**Артикул №: 793-5501/000-017**

WMB marking card; as card; for terminal block width 5 - 17.5 mm; stretchable 5 - 5.2 mm; plain; snap-on type; green

www.wago.com/793-5501/000-017**Артикул №: 793-5501/000-023**

WMB marking card; as card; for terminal block width 5 - 17.5 mm; stretchable 5 - 5.2 mm; plain; snap-on type; light green

www.wago.com/793-5501/000-023**Артикул №: 793-5501/000-024**

WMB marking card; as card; for terminal block width 5 - 17.5 mm; stretchable 5 - 5.2 mm; plain; snap-on type; violet

www.wago.com/793-5501/000-024**tools****Артикул №: 210-658**

Operating tool; Blade: 3.5 x 0.5 mm; with a partially insulated shaft; angled; short; multicoloured

www.wago.com/210-658**Артикул №: 210-720**

Operating tool; Blade: 3.5 x 0.5 mm; with a partially insulated shaft; multicoloured

www.wago.com/210-720**End plate****Артикул №: 2002-1293**

Separator plate; 2 mm thick; oversized; gray

www.wago.com/2002-1293**Артикул №: 2002-1294**

Separator plate; 2 mm thick; oversized; orange

www.wago.com/2002-1294**Артикул №: 209-190**

Separator for Ex e/Ex i applications; 3 mm thick; 90 mm wide; orange

www.wago.com/209-190**Артикул №: 209-191**

Separator for Ex e/Ex i applications; 3 mm thick; 120 mm wide; orange

www.wago.com/209-191**Jumper****Артикул №: 2002-400**

Continuous jumper; 2-way; insulated; light gray

www.wago.com/2002-400**Артикул №: 2002-402**

Jumper; 2-way; insulated; light gray

www.wago.com/2002-402**Артикул №: 2002-402/000-005**

Jumper; 2-way; insulated; red

www.wago.com/2002-402/000-005

Подлежи на промяна. Моля, обърнете внимание и на допълнителната документация на продукта!

ВАГО България ООД

Бизнес център Сердика

Бул."Акад. Иван Гешов" 2Е | Сграда 1, ет. 4, офис 417 | 1330 София

Тел.: +359 2 489 46 09 | Тел.: +359 2 489 46 10

Имейл: sales.bg@wago.com

Имате ли въпроси относно нашите продукти?















Винаги ще се радваме да получим вашето обаждане на +359 2 489 46 09.

	Артикул №: 2002-402/000-006 Jumper; 2-way; insulated; blue	www.wago.com/2002-402/000-006
	Артикул №: 2002-403 Jumper; 3-way; insulated; light gray	www.wago.com/2002-403
	Артикул №: 2002-403/000-005 Jumper; 3-way; insulated; red	www.wago.com/2002-403/000-005
	Артикул №: 2002-403/000-006 Jumper; 3-way; insulated; blue	www.wago.com/2002-403/000-006
	Артикул №: 2002-404 Jumper; 4-way; insulated; light gray	www.wago.com/2002-404
	Артикул №: 2002-404/000-005 Jumper; 4-way; insulated; red	www.wago.com/2002-404/000-005
	Артикул №: 2002-404/000-006 Jumper; 4-way; insulated; blue	www.wago.com/2002-404/000-006
	Артикул №: 2002-405 Jumper; 5-way; insulated; light gray	www.wago.com/2002-405
	Артикул №: 2002-405/000-005 Jumper; 5-way; insulated; red	www.wago.com/2002-405/000-005
	Артикул №: 2002-405/000-006 Jumper; 5-way; insulated; blue	www.wago.com/2002-405/000-006
	Артикул №: 2002-405/011-000 Star point jumper; 3-way; insulated; light gray	www.wago.com/2002-405/011-000
	Артикул №: 2002-406 Jumper; 6-way; insulated; light gray	www.wago.com/2002-406
	Артикул №: 2002-406/000-005 Jumper; 6-way; insulated; red	www.wago.com/2002-406/000-005
	Артикул №: 2002-406/000-006 Jumper; 6-way; insulated; blue	www.wago.com/2002-406/000-006

Подлежи на промяна. Моля, обърнете внимание и на допълнителната документация на продукта!

ВАГО България ООД
Бизнес център Сердика
Бул."Акад. Иван Гешов" 2Е | Сграда 1, ет. 4, офис 417 | 1330 София
Тел.: +359 2 489 46 09 | Тел.: +359 2 489 46 10
Имейл: sales.bg@wago.com

Имате ли въпроси относно нашите продукти?
Винаги ще се радваме да получим вашето обаждане на +359 2 489 46 09.

	Артикул №: 2002-406/020-000 Delta jumper; insulated; light gray	www.wago.com/2002-406/020-000
	Артикул №: 2002-407 Jumper; 7-way; insulated; light gray	www.wago.com/2002-407
	Артикул №: 2002-407/000-005 Jumper; 7-way; insulated; red	www.wago.com/2002-407/000-005
	Артикул №: 2002-407/000-006 Jumper; 7-way; insulated; blue	www.wago.com/2002-407/000-006
	Артикул №: 2002-408 Jumper; 8-way; insulated; light gray	www.wago.com/2002-408
	Артикул №: 2002-408/000-005 Jumper; 8-way; insulated; red	www.wago.com/2002-408/000-005
	Артикул №: 2002-408/000-006 Jumper; 8-way; insulated; blue	www.wago.com/2002-408/000-006
	Артикул №: 2002-409 Jumper; 9-way; insulated; light gray	www.wago.com/2002-409
	Артикул №: 2002-409/000-005 Jumper; 9-way; insulated; red	www.wago.com/2002-409/000-005
	Артикул №: 2002-409/000-006 Jumper; 9-way; insulated; blue	www.wago.com/2002-409/000-006
	Артикул №: 2002-410 Jumper; 10-way; insulated; light gray	www.wago.com/2002-410
	Артикул №: 2002-410/000-005 Jumper; 10-way; insulated; red	www.wago.com/2002-410/000-005
	Артикул №: 2002-410/000-006 Jumper; 10-way; insulated; blue	www.wago.com/2002-410/000-006
	Артикул №: 2002-423 Continuous jumper; from 1 to 3; insulated; light gray	www.wago.com/2002-423
	Артикул №: 2002-423/000-005 Continuous jumper; from 1 to 3; insulated; red	www.wago.com/2002-423/000-005

Подлежи на промяна. Моля, обърнете внимание и на допълнителната документация на продукта!

ВАГО България ООД
Бизнес център Сердика
Бул."Акад. Иван Гешов" 2Е | Сграда 1, ет. 4, офис 417 | 1330 София
Тел.: +359 2 489 46 09 | Тел.: +359 2 489 46 10
Имейл: sales.bg@wago.com















Имате ли въпроси относно нашите продукти?
Винаги ще се радваме да получим вашето обаждане на +359 2 489 46 09.

	Артикул №: 2002-423/000-006 Continuous jumper; from 1 to 3; insulated; blue	www.wago.com/2002-423/000-006
	Артикул №: 2002-433 Jumper; from 1 to 3; insulated; light gray	www.wago.com/2002-433
	Артикул №: 2002-434 Jumper; from 1 to 4; insulated; light gray	www.wago.com/2002-434
	Артикул №: 2002-435 Jumper; from 1 to 5; insulated; light gray	www.wago.com/2002-435
	Артикул №: 2002-436 Jumper; from 1 to 6; insulated; light gray	www.wago.com/2002-436
	Артикул №: 2002-437 Jumper; from 1 to 7; insulated; light gray	www.wago.com/2002-437
	Артикул №: 2002-438 Jumper; from 1 to 8; insulated; light gray	www.wago.com/2002-438
	Артикул №: 2002-439 Jumper; from 1 to 9; insulated; light gray	www.wago.com/2002-439
	Артикул №: 2002-440 Jumper; from 1 to 10; insulated; light gray	www.wago.com/2002-440
	Артикул №: 2002-472 Staggered jumper; 2-way; insulated; light gray	www.wago.com/2002-472
	Артикул №: 2002-473 Staggered jumper; 3-way; insulated; light gray	www.wago.com/2002-473
	Артикул №: 2002-473/011-000 Staggered jumper; 2-way; from 1 to 3; insulated; light gray	www.wago.com/2002-473/011-000
	Артикул №: 2002-474 Staggered jumper; 4-way; insulated; light gray	www.wago.com/2002-474
	Артикул №: 2002-475 Staggered jumper; 5-way; insulated; light gray	www.wago.com/2002-475
	Артикул №: 2002-475/011-000 Staggered jumper; 3-way; insulated; light gray	www.wago.com/2002-475/011-000
	Артикул №: 2002-476 Staggered jumper; 6-way; insulated; light gray	www.wago.com/2002-476
	Артикул №: 2002-477 Staggered jumper; 7-way; insulated; light gray	www.wago.com/2002-477

















Подлежи на промяна. Моля, обърнете внимание и на допълнителната документация на продукта!

ВАГО България ООД
Бизнес център Сердика
Бул."Акад. Иван Гешов" 2Е | Сграда 1, ет. 4, офис 417 | 1330 София
Тел.: +359 2 489 46 09 | Тел.: +359 2 489 46 10
Имейл: sales.bg@wago.com

Имате ли въпроси относно нашите продукти?
Винаги ще се радваме да получим вашето обаждане на +359 2 489 46 09.

	Артикул №: 2002-477/011-000 Staggered jumper; insulated; light gray	www.wago.com/2002-477/011-000
	Артикул №: 2002-478 Staggered jumper; 8-way; insulated; light gray	www.wago.com/2002-478
	Артикул №: 2002-479 Staggered jumper; 9-way; insulated; light gray	www.wago.com/2002-479
	Артикул №: 2002-479/011-000 Staggered jumper; insulated; light gray	www.wago.com/2002-479/011-000
	Артикул №: 2002-480 Staggered jumper; 10-way; insulated; light gray	www.wago.com/2002-480
	Артикул №: 2002-481 Staggered jumper; 11-way; insulated; light gray	www.wago.com/2002-481
	Артикул №: 2002-481/011-000 Staggered jumper; insulated; light gray	www.wago.com/2002-481/011-000
	Артикул №: 2002-482 Staggered jumper; 12-way; insulated; light gray	www.wago.com/2002-482
	Артикул №: 2006-499 Step-down jumper; insulated; light gray	www.wago.com/2006-499
	Артикул №: 2016-499 Step-down jumper; insulated; light gray	www.wago.com/2016-499
	Артикул №: 210-103 Wire commoning chain; insulated; black	www.wago.com/210-103
	Артикул №: 210-123 Wire commoning chain; insulated; blue	www.wago.com/210-123
Protective Warning Marker		
	Артикул №: 2002-115 Protective warning marker; with high-voltage symbol, black; for 5 terminal blocks; yellow	www.wago.com/2002-115
check		
	Артикул №: 2002-511 Modular TOPJOB®S connector; modular; for jumper contact slot; 1-pole; 2,50 mm ² ; gray	www.wago.com/2002-511
	Артикул №: 2002-549 Spacer module; modular; e.g., for bridging commoned terminal blocks; gray	www.wago.com/2002-549
	Артикул №: 2002-552 Modular TOPJOB®S connector; modular; for jumper contact slot; 2-pole; 2,50 mm ² ; gray	www.wago.com/2002-552







Подлежи на промяна. Моля, обърнете внимание и на допълнителната документация на продукта!

	Артикул №: 2002-553 Modular TOPJOB®S connector; modular; for jumper contact slot; 3-pole; 2,50 mm ² ; gray	www.wago.com/2002-553
	Артикул №: 2002-554 Modular TOPJOB®S connector; modular; for jumper contact slot; 4-pole; 2,50 mm ² ; gray	www.wago.com/2002-554
	Артикул №: 2002-555 Modular TOPJOB®S connector; modular; for jumper contact slot; 5-pole; 2,50 mm ² ; gray	www.wago.com/2002-555
	Артикул №: 2002-556 Modular TOPJOB®S connector; modular; for jumper contact slot; 6-pole; 2,50 mm ² ; gray	www.wago.com/2002-556
	Артикул №: 2002-557 Modular TOPJOB®S connector; modular; for jumper contact slot; 7-pole; 2,50 mm ² ; gray	www.wago.com/2002-557
	Артикул №: 2002-558 Modular TOPJOB®S connector; modular; for jumper contact slot; 8-pole; 2,50 mm ² ; gray	www.wago.com/2002-558
	Артикул №: 2002-559 Modular TOPJOB®S connector; modular; for jumper contact slot; 9-pole; 2,50 mm ² ; gray	www.wago.com/2002-559
	Артикул №: 2002-560 Modular TOPJOB®S connector; modular; for jumper contact slot; 10-pole; 2,50 mm ² ; gray	www.wago.com/2002-560
	Артикул №: 2002-611 TOPJOB®S L-type test plug module; modular; 1-pole; 2,50 mm ² ; gray	www.wago.com/2002-611
	Артикул №: 2002-649 TOPJOB®S L-type spacer module; modular; e.g., for bridging commoned terminal blocks; gray	www.wago.com/2002-649
	Артикул №: 2009-174 Test plug adapter; for 4 mm Ø test plugs; for testing TOPJOB®S rail-mounted terminal blocks; gray	www.wago.com/2009-174
	Артикул №: 2009-182 Testing tap; for max. 2.5 mm ² ; tool-free connection for individual test wires 0.08 - 2.5 mm; gray	www.wago.com/2009-182
Carrier rail		
	Артикул №: 210-112 Steel carrier rail; 35 x 7.5 mm; 1 mm thick; 2 m long; slotted; according to EN 60715; "Hole width 25 mm; silver-colored	www.wago.com/210-112
	Артикул №: 210-113 Steel carrier rail; 35 x 7.5 mm; 1 mm thick; 2 m long; unslotted; according to EN 60715; silver-colored	www.wago.com/210-113
	Артикул №: 210-114 Steel carrier rail; 35 x 15 mm; 1.5 mm thick; 2 m long; unslotted; similar to EN 60715; silver-colored	www.wago.com/210-114
	Артикул №: 210-115 Steel carrier rail; 35 x 7.5 mm; 1 mm thick; 2 m long; slotted; according to EN 60715; "Hole width 18 mm; silver-colored	www.wago.com/210-115
	Артикул №: 210-118 Steel carrier rail; 35 x 15 mm; 2.3 mm thick; 2 m long; unslotted; according to EN 60715; silver-colored	www.wago.com/210-118

Подлежи на промяна. Моля, обърнете внимание и на допълнителната документация на продукта!

ВАГО България ООД
Бизнес център Сердика
Бул."Акад. Иван Гешов" 2Е | Сграда 1, ет. 4, офис 417 | 1330 София
Тел.: +359 2 489 46 09 | Тел.: +359 2 489 46 10
Имейл: sales.bg@wago.com

Имате ли въпроси относно нашите продукти?
Винаги ще се радваме да получим вашето обаждане на +359 2 489 46 09.

	Артикул №: 210-196 Aluminum carrier rail; 35 x 8.2 mm; 1.6 mm thick; 2 m long; unslotted; similar to EN 60715; silver-colored	www.wago.com/210-196
	Артикул №: 210-197 Steel carrier rail; 35 x 15 mm; 1.5 mm thick; 2 m long; slotted; similar to EN 60715; silver-colored	www.wago.com/210-197
	Артикул №: 210-198 Copper carrier rail; 35 x 15 mm; 2.3 mm thick; 2 m long; unslotted; according to EN 60715; copper-colored	www.wago.com/210-198
	Артикул №: 210-504 Steel carrier rail; 35 x 7.5 mm; 1 mm thick; 2 m long; slotted; galvanized; according to EN 60715	www.wago.com/210-504
	Артикул №: 210-505 Steel carrier rail; 35 x 7.5 mm; 1 mm thick; 2 m long; unslotted; galvanized; according to EN 60715; silver-colored	www.wago.com/210-505
	Артикул №: 210-506 Steel carrier rail; 35 x 15 mm; 1.5 mm thick; 2 m long; unslotted; galvanized; similar to EN 60715; silver-colored	www.wago.com/210-506
	Артикул №: 210-508 Steel carrier rail; 35 x 15 mm; 1.5 mm thick; 2 m long; slotted; galvanized; similar to EN 60715; silver-colored	www.wago.com/210-508

Изтегляния

Documentation

Bid Text

2002-1201 X81 - Datei	Apr 29, 2019	xml 4,2 kB	Изтегляне
2002-1201 docx - Datei	Apr 23, 2019	docx 15,0 kB	Изтегляне

Additional Information

Technical explanations	Apr 3, 2019	pdf 2,2 MB	Изтегляне
------------------------	-------------	---------------	-----------

CAD/CAE-Data

CAD data

2D/3D Models 2002-1201	URL	Изтегляне
------------------------	-----	-----------

CAE data

EPLAN Data Portal 2002-1201	URL	Изтегляне
-----------------------------	-----	-----------

Подлежи на промяна. Моля, обърнете внимание и на допълнителната документация на продукта!

ВАГО България ООД
Бизнес център Сердика
Бул."Акад. Иван Гешов" 2Е | Сграда 1, ет. 4, офис 417 | 1330 София
Тел.: +359 2 489 46 09 | Тел.: +359 2 489 46 10
Имейл: sales.bg@wago.com

Имате ли въпроси относно нашите продукти?
Винаги ще се радваме да получим вашето обаждане на +359 2 489 46 09.

Бележки за инсталиране

Conductor termination

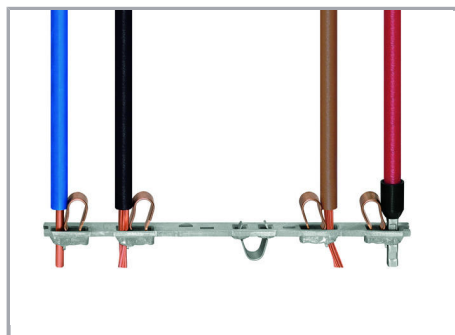

All conductor types at a glance

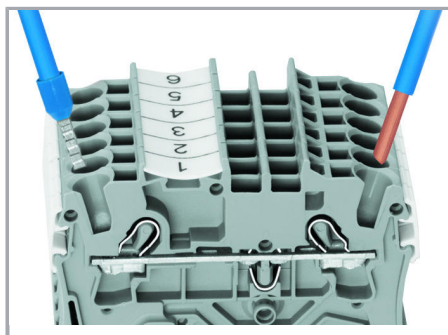

Terminating solid and ferruled conductors via push-in connection.

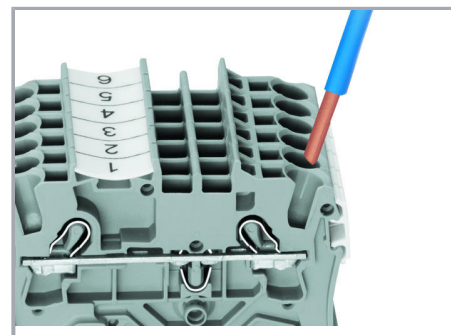

Inserting conductors via push-in termination.

Solid conductors with cross-sections from either one size above, or up to two sizes below, the rated cross-section can be simply pushed in – no tools needed.

Подлежи на промяна. Моля, обърнете внимание и на допълнителната документация на продукта!

ВАГО България ООД
Бизнес център Сердика
Бул."Акад. Иван Гешов" 2Е | Сграда 1, ет. 4, офис 417 | 1330 София
Тел.: +359 2 489 46 09 | Тел.: +359 2 489 46 10
Имейл: sales.bg@wago.com

Имате ли въпроси относно нашите продукти?
Винаги ще се радваме да получим вашето обаждане на +359 2 489 46 09.

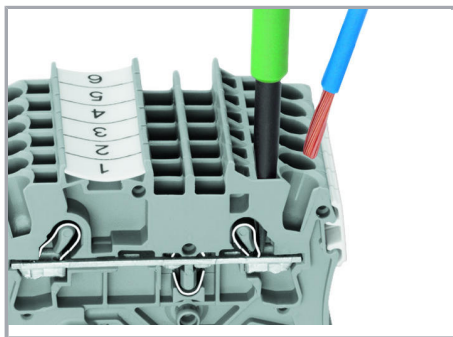

Inserting a conductor via operating tool.

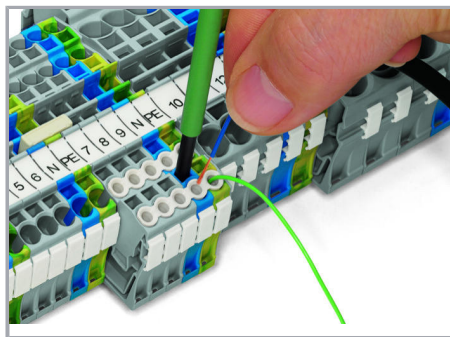

Conductor termination – Insulation stop.

Connecting fine-stranded conductors without ferrules, or small cross-sectional conductors that cannot be pushed in, is performed similarly to the original CAGE CLAMP® – just use an operating tool.

The smart feature:

To open the clamp, the operating tool is inserted vertically. The conductor entry is less than 15 degrees for easier wiring.

Commoning

Подлежи на промяна. Моля, обърнете внимание и на допълнителната документация на продукта!

ВАГО България ООД
Бизнес център Сердика
Бул."Акад. Иван Гешов" 2Е | Сграда 1, ет. 4, офис 417 | 1330 София
Тел.: +359 2 489 46 09 | Тел.: +359 2 489 46 10
Имейл: sales.bg@wago.com

Имате ли въпроси относно нашите продукти?
Винаги ще се радваме да получим вашето обаждане на +359 2 489 46 09.

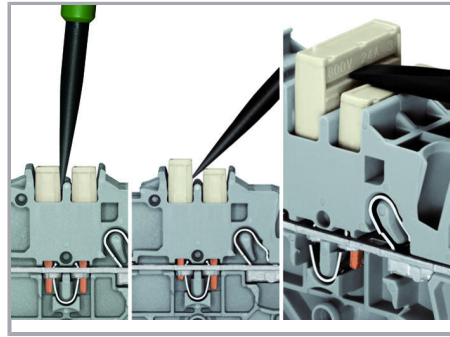
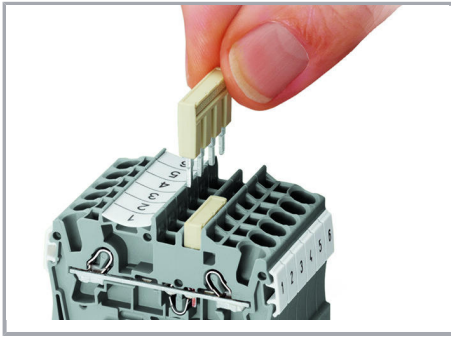

The push-in type jumper bar system is based on the common plug and socket principle. Each terminal block is spring-loaded with a double socket and a resilient CrNi steel spring. The jumper contact material is pure electrolytic copper, which allows for an extremely small design capable of carrying the full-rated current of the terminal block. Ground terminal blocks can also be commoned using the same jumper system. Custom jumpers are created by breaking and removing jumper contacts (2000, 2001, 2002, 2004 Series).

Removing a push-in type jumper bar.

Insert the operating tool between the jumper and the partition wall of the dual jumper slots, then lift up the jumper.

Place the operating tool in the center of jumpers up to five contacts (see above), or alternately on both sides for jumpers with more than five contacts.

Commoning

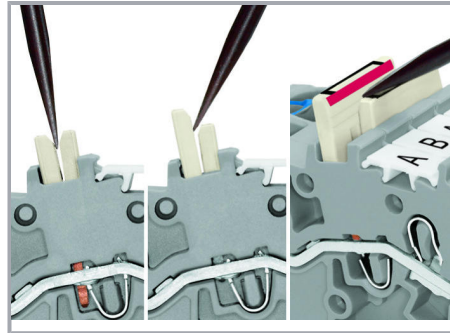
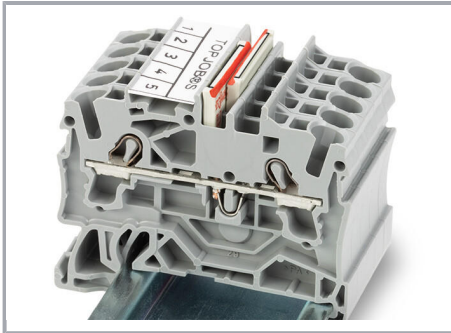

Locate red stripes of the staggered jumpers on the inside.

Removing a staggered jumper:

Insert staggered jumper and push down until it hits backstop.

Insert the operating tool between the staggered jumpers, then lift up the jumper.

Commoning

Подлежи на промяна. Моля, обърнете внимание и на допълнителната документация на продукта!

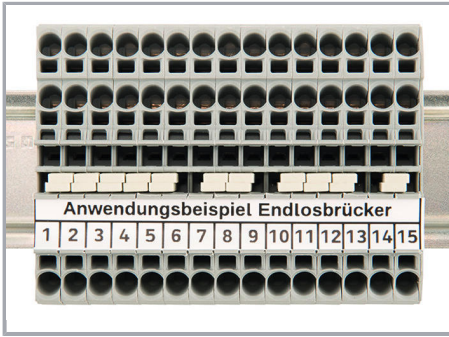

Continuous jumpers (2002 Series) readily connect an endless number of terminal blocks to each other via a single jumper slot. Use the second jumper slot for additional commoning or testing.

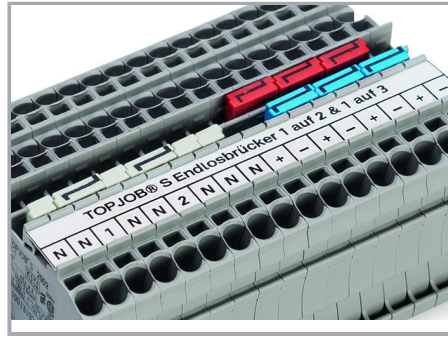

The 1-to-3 adjacent jumper for continuous commoning enables every other terminal block to be commoned. For example, positive and negative potentials can be accommodated alongside each other.

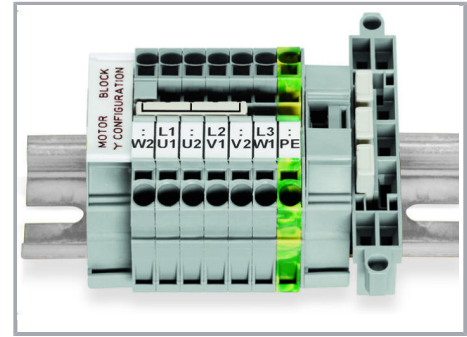

This star point jumper has been specially developed to create a "star point" and is used on motor terminal boards equipped with TOPJOB® S rail-mount terminal blocks.

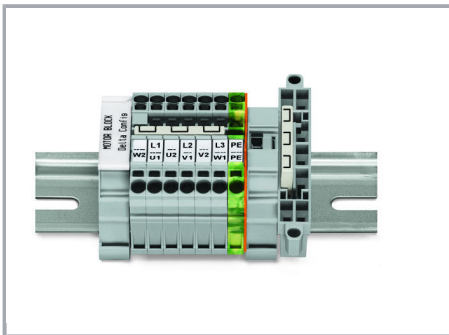

This delta jumper has been specially developed to create a delta configuration and is used on motor terminal boards equipped with TOPJOB® S rail-mount terminal blocks.

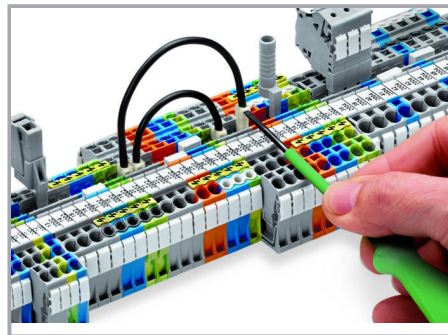

Push down the wire jumper until fully inserted. Lift the jumper with an operating tool for rewiring.

Commoning

Подлежи на промяна. Моля, обърнете внимание и на допълнителната документация на продукта!

ВАГО България ООД
 Бизнес център Сердика
 Бул."Акад. Иван Гешов" 2Е | Сграда 1, ет. 4, офис 417 | 1330 София
 Тел.: +359 2 489 46 09 | Тел.: +359 2 489 46 10
 Имейл: sales.bg@wago.com

Имате ли въпроси относно нашите продукти?
 Винаги ще се радваме да получим вашето обаждане на +359 2 489 46 09.

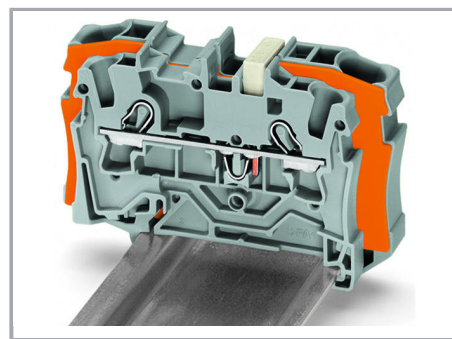
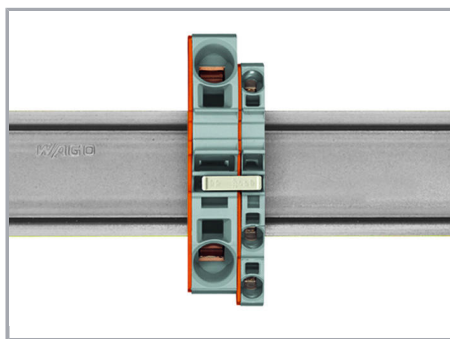
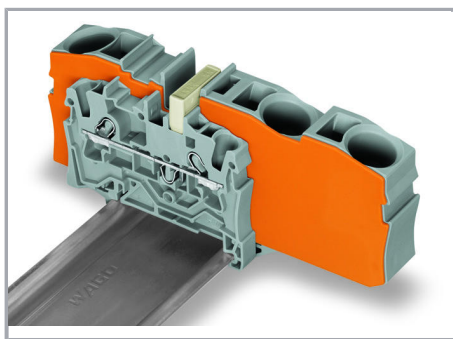

Step-down jumpers may common terminal blocks of different sizes, without losing a conductor clamping point. This can be beneficial on long conductor runs where voltage drops may be problematic. A large conductor can be easily connected to smaller conductors at the distribution point.

Using step-down jumpers, an end plate must be inserted between the terminal blocks to be commoned.

Step-down jumper (2006-499) commons 6 /4 mm² (10/12 AWG) terminal blocks (2006 /2004 Series) with 4/2.5/1.5 mm² (12/14/16 AWG) terminal blocks (2004/2002/2001 Series).

Commoning may be made in either direction using the special thin end plate to cover the open side. Additional through terminal blocks having a smaller cross-section may be commoned using push-in type jumper bars.

Подлежи на промяна. Моля, обърнете внимание и на допълнителната документация на продукта!

ВАГО България ООД
Бизнес център Сердика
Бул."Акад. Иван Гешов" 2Е | Сграда 1, ет. 4, офис 417 | 1330 София
Тел.: +359 2 489 46 09 | Тел.: +359 2 489 46 10
Имейл: sales.bg@wago.com

Имате ли въпроси относно нашите продукти?
Винаги ще се радваме да получим вашето обаждане на +359 2 489 46 09.

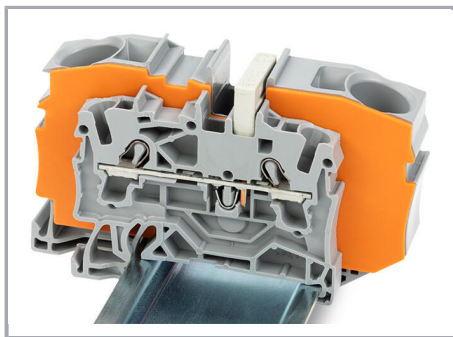

Step-down jumper (2016-499) commons 16 /10 mm² (16/8 AWG) terminal blocks (2016 /2010 Series) with 10/6/4/2.5 mm² (8/10/12 /14 AWG) terminal blocks (2010/2006/2004 /2002 Series).

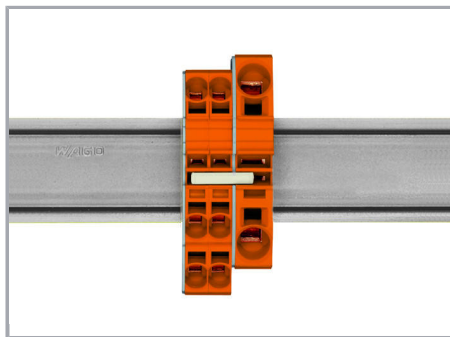

Stepping down via push-in type jumper bar.

Commoning via open terminal side with end plate allows jumpering over two cross-section sizes for 16 mm² (6 AWG) and 10 mm² (8 AWG) and one cross-section size for 6/4/2.5 mm² (10/12/14 AWG). An example: from 16 mm² (6 AWG) to 6 mm² (10 AWG) (see illustration above) or from 10 mm² (8 AWG) to 4 mm² (12 AWG).

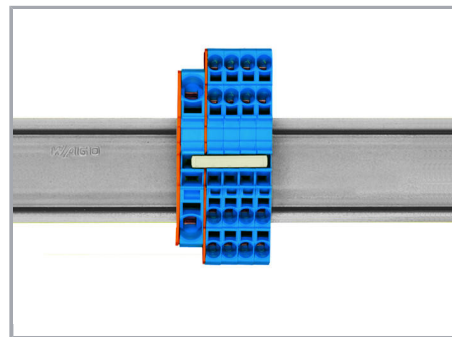

Stepping down via push-in type jumper bar.

Commoning via closed terminal side with end plate allows jumpering over two cross-section sizes, e.g., from 16 mm² (6 AWG) to 6 mm² (10 AWG) or from 6 mm² (10 AWG) to 2.5 mm² (14 AWG) (see illustration above).

Подлежи на промяна. Моля, обърнете внимание и на допълнителната документация на продукта!

ВАГО България ООД
Бизнес център Сердика
Бул."Акад. Иван Гешов" 2Е | Сграда 1, ет. 4, офис 417 | 1330 София
Тел.: +359 2 489 46 09 | Тел.: +359 2 489 46 10
Имейл: sales.bg@wago.com

Имате ли въпроси относно нашите продукти?
Винаги ще се радваме да получим вашето обаждане на +359 2 489 46 09.

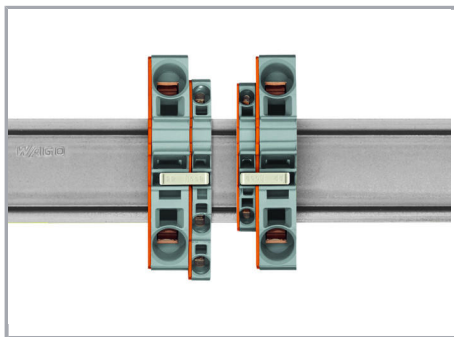

Note:

The total current of the outgoing circuits shall not exceed the nominal current of the step-down jumper/push-in type jumper bar.

Testing

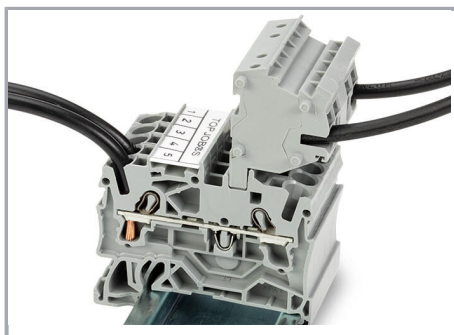

The modular TOPJOB® S connectors also connect conductors of the same size as the terminal blocks being used.

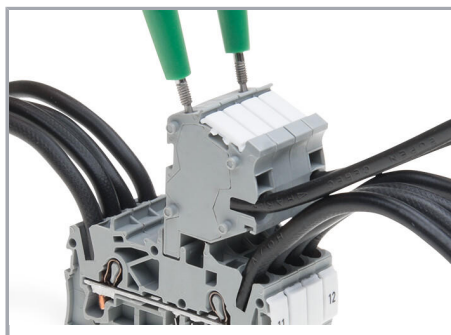

TOPJOB® S Connectors with a 2 mm Ø test socket for testing voltage via 2-pole voltage tester

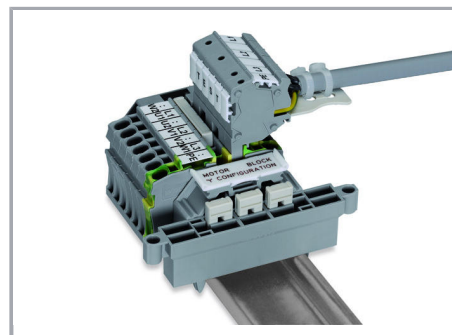

Rail-mount terminal block assembly for electric motor wiring

Подлежи на промяна. Моля, обърнете внимание и на допълнителната документация на продукта!

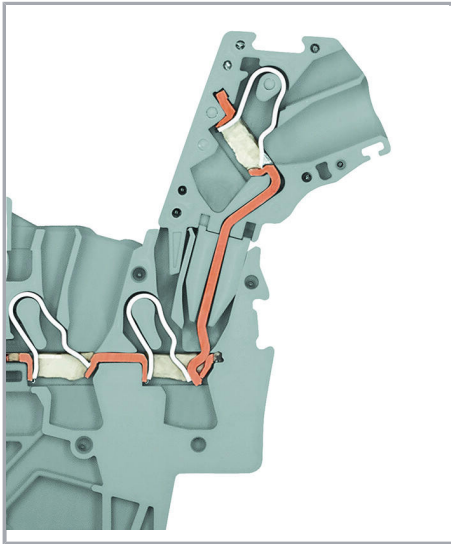

L-type test plug module – cross-sectional view of contacts

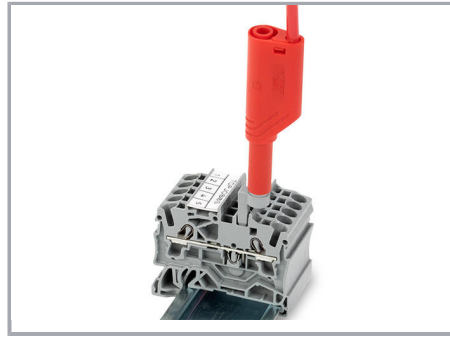

Test plug adapter (2009-174, CAT I) for 4 mm Ø plugs – compatible with 2000 to 2016 Series

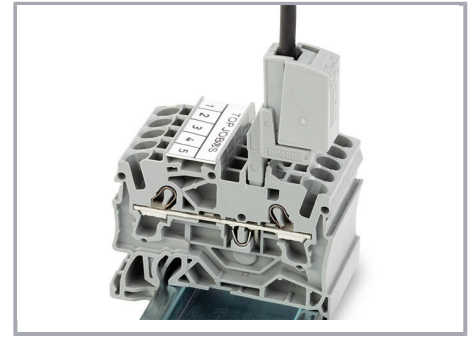

Testing tap (2009-182) for tool-free connection of test cables up to 2.5 mm² (12 AWG) – compatible with 2000 to 2016 Series

Marking

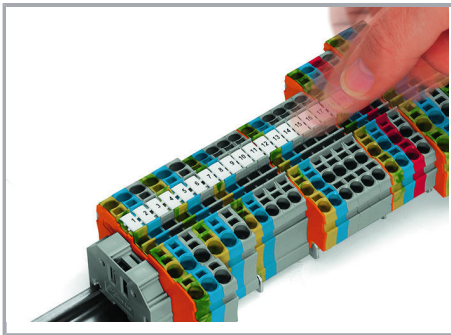

Snapping WMB Inline markers into marker slots.

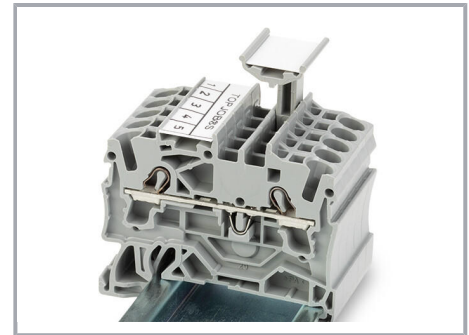
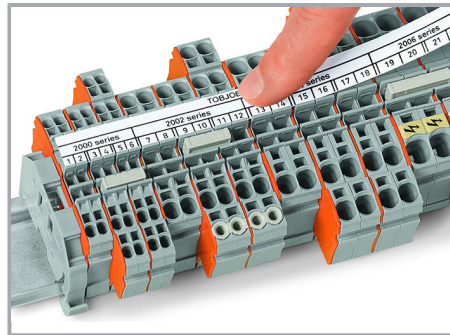

TOPJOB® S 2009-193 Group Marker Carrier (equipped with a marking strip) for all 2001 to 2016 Series TOPJOB® S Rail-Mount Terminal Blocks

Do not use on an end plate!

Подлежи на промяна. Моля, обърнете внимание и на допълнителната документация на продукта!

ВАГО България ООД
Бизнес център Сердика
Бул."Акад. Иван Гешов" 2Е | Сграда 1, ет. 4, офис 417 | 1330 София
Тел.: +359 2 489 46 09 | Тел.: +359 2 489 46 10
Имейл: sales.bg@wago.com

Имате ли въпроси относно нашите продукти?
Винаги ще се радваме да получим вашето обаждане на +359 2 489 46 09.

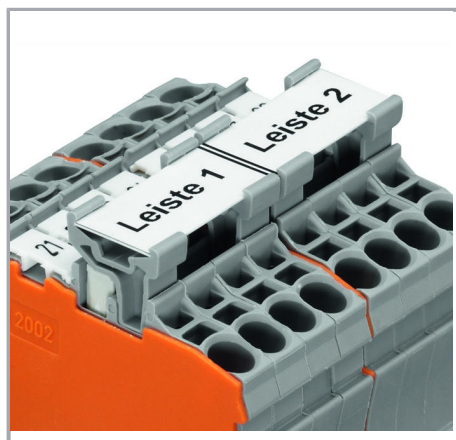

Using marker carriers for marking strips (2002-161) in jumper slots.

Ex application

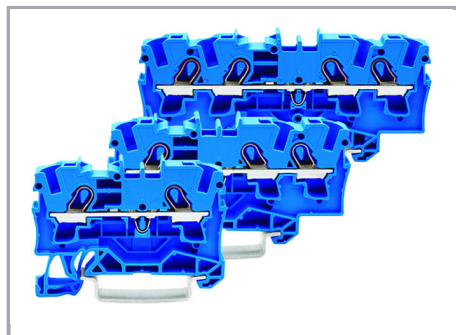

Through terminal blocks with a blue insulated housing are suitable for Ex i applications.



All through and ground conductor terminal blocks are suitable for Ex e II applications.

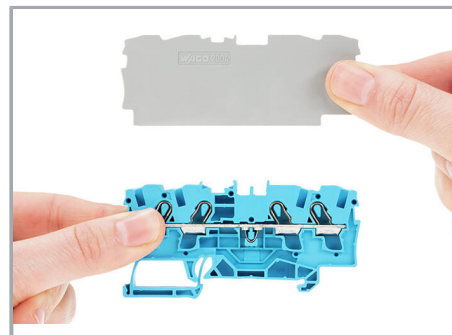

Separator for Ex e/Ex applications

An end plate must be applied to the terminal block located directly behind an Ex e/Ex i separator plate.

Подлежи на промяна. Моля, обърнете внимание и на допълнителната документация на продукта!

ВАГО България ООД
Бизнес център Сердика
Бул."Акад. Иван Гешов" 2Е | Сграда 1, ет. 4, офис 417 | 1330 София
Тел.: +359 2 489 46 09 | Тел.: +359 2 489 46 10
Имейл: sales.bg@wago.com

Имате ли въпроси относно нашите продукти?
Винаги ще се радваме да получим вашето обаждане на +359 2 489 46 09.

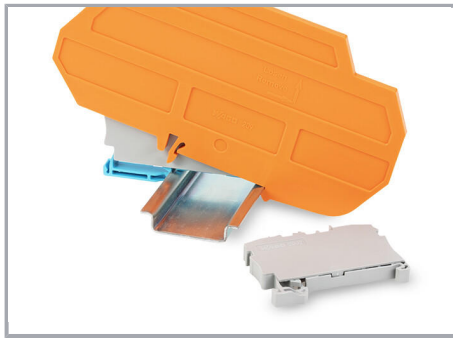

Ex e II/Ex i terminal strip

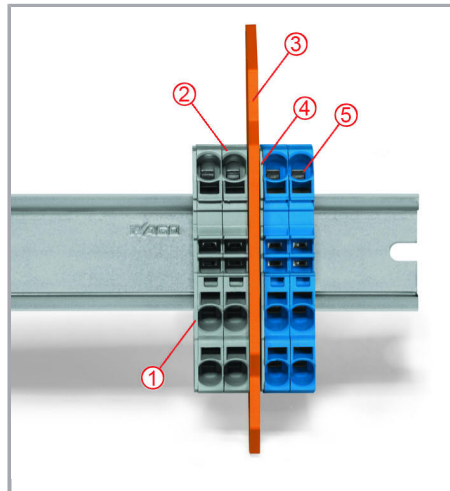

Separator located between Ex e II and Ex i terminal strip

Notice:

The movable feet of terminal blocks and separator plates must face the same direction.

End plate

Ex e II terminal blocks

Separator for Ex e/Ex i applications

End plate

Ex i terminal blocks

According to EN 50020, a minimum distance of 50 mm must be kept between live parts of Ex e and Ex i circuits. The use of Ex e/Ex i separators is a space-saving solution when Ex e and Ex i terminal blocks are mounted on a common carrier rail.

Семейство продукти

Подлежи на промяна. Моля, обърнете внимание и на допълнителната документация на продукта!

ВАГО България ООД
Бизнес център Сердика
Бул."Акад. Иван Гешов" 2Е | Сграда 1, ет. 4, офис 417 | 1330 София
Тел.: +359 2 489 46 09 | Тел.: +359 2 489 46 10
Имейл: sales.bg@wago.com

Имате ли въпроси относно нашите продукти?
Винаги ще се радваме да получим вашето обаждане на +359 2 489 46 09.



TOPJOB® S

TOPJOB® S: In various industrial applications and modern building installations, WAGO's wide and versatile range of rail-mount terminal blocks provides more than just reliable electrical connections.

Показване на всички продукти от семейството.

Подлежи на промяна. Моля, обърнете внимание и на допълнителната документация на продукта!

ВАГО България ООД
Бизнес център Сердика
Бул."Акад. Иван Гешов" 2Е | Сграда 1, ет. 4, офис 417 | 1330 София
Тел.: +359 2 489 46 09 | Тел.: +359 2 489 46 10
Имейл: sales.bg@wago.com

Имате ли въпроси относно нашите продукти?
Винаги ще се радваме да получим вашето обаждане на +359 2 489 46 09.