

## Room thermostats

RDG200T.., RDG260T..



### For fan coil units, universal applications and compressors in DX-type equipment applications

- Built-in temperature sensor
- Control room temperature level
- RDG20..T triac control outputs for On/Off, PWM or 3-position
- RDG26..T control outputs for DC 0...10 V or On/Off
- Fan outputs for 3-speed, 1-speed or DC 0...10 V
- 3 multifunctional inputs X1, X2 and X3 for keycard, external sensor, etc.
- Operating modes: Comfort, Economy and Protection
- Automatic or manual fan speed control
- Automatic or manual heating/cooling changeover
- Commissioning via local HMI
- Commissioning via Siemens smartphone application PCT Go
- Power reserve clock for 20 h during power failure
- Operating voltage:
  - RDG20..T: AC 230 V
  - RDG26..T: AC 24 V or DC 24 V

## Functions

- Control application The RDG2..T room thermostats are designed for use with the following:
- Fan coil units** via On/Off or modulating/DC control outputs:
- 2-pipe system
  - 2-pipe system with electric heater
  - 2-pipe system with radiator/floor heating
  - 2-pipe/2-stage system also suitable for applications with 1-stage heating/ 2-stage cooling, or 2-stage heating/1-stage cooling
  - 4-pipe system
  - 4-pipe system with electric heater
  - 4-pipe system with a 6-port ball valve (RDG26..T)
  - 4-pipe system with 6-port PICV (RDG26..T)
  - 4-pipe system with PICV and 6-port ball valve as changeover (RDG26..T)
- Chilled/heated ceilings (or radiators)** via On/Off or modulating/DC control outputs:
- Chilled/heated ceiling
  - Chilled/heated ceiling with electric heater
  - Chilled/heated ceiling and radiator/floor heating
  - Chilled ceiling and radiator/floor heating
  - Chilled and/or heated ceiling/2-stage
  - Chilled/heated ceiling (4-pipe) with 6-port ball valve (RDG26..T)
  - Chilled/heated ceiling (4-pipe) with 6-port PICV (RDG26..T)
  - Chilled/heated ceiling with PICV and 6-port ball valve as changeover (RDG26..T)
- Compressor applications** via On/Off control:
- Heating or cooling, compressor in DX-type equipment
  - Heating or cooling, compressor in DX-type equipment with electric heater
  - Heating and cooling, compressor in DX-type equipment
  - Heating or cooling/2-stage, compressor in DX-type equipment
- General functions
- Weekly scheduler
  - Room temperature control via built-in temperature sensor or external room temperature/return air temperature sensor
  - Floor heating temperature limitation
  - Min. and max. supply air temperature limitation
  - Selection of operating modes via operating mode button
  - Button lock for all buttons independently (automatically or manually)
  - Changeover between heating and cooling mode (automatic via local sensor or manually)
  - Parameters protected by password (disabled by default)
  - Purge function together with 2-port valve
  - Valve kick/exercising function to prevent gripping
  - Reminder to clean fan filters
  - Delta temperature control  
Limiting temperature difference between flow and return temperature for water to optimize the system and reduce energy consumption in district heating systems
  - Power reserve clock for 20 h during power failure

- |                       |                                                                                                                                                                                                                                                                                                                                                                                                                                                                                                                                                                                                                                                                                                                                                                                                                                                                                                                                                                                                                                                                                                                                                                                                                                                                                                                      |
|-----------------------|----------------------------------------------------------------------------------------------------------------------------------------------------------------------------------------------------------------------------------------------------------------------------------------------------------------------------------------------------------------------------------------------------------------------------------------------------------------------------------------------------------------------------------------------------------------------------------------------------------------------------------------------------------------------------------------------------------------------------------------------------------------------------------------------------------------------------------------------------------------------------------------------------------------------------------------------------------------------------------------------------------------------------------------------------------------------------------------------------------------------------------------------------------------------------------------------------------------------------------------------------------------------------------------------------------------------|
| Setpoints and display | <ul style="list-style-type: none"> <li>● Min. and max. limitation of room temperature setpoint: <ul style="list-style-type: none"> <li>– Comfort limitation (min. and max. limitation)</li> <li>– Energy saving concept (min. and max. limitation separate for heating and cooling)</li> </ul> </li> <li>● Temporary Comfort mode extension</li> <li>● Display of current room temperature or setpoint in °C, °F or both</li> </ul>                                                                                                                                                                                                                                                                                                                                                                                                                                                                                                                                                                                                                                                                                                                                                                                                                                                                                  |
| Setting               | <ul style="list-style-type: none"> <li>● Application selection via DIP switches or external commissioning software (Siemens smartphone application PCT Go)</li> <li>● Parameter download with external commissioning software (Siemens smartphone application PCT Go)</li> <li>● Reloading factory settings for commissioning and control parameters</li> </ul>                                                                                                                                                                                                                                                                                                                                                                                                                                                                                                                                                                                                                                                                                                                                                                                                                                                                                                                                                      |
| Fan                   | <ul style="list-style-type: none"> <li>● 1-speed, 3-speed or DC 0...10 V fan control on RDG20..T and RDG26..T (automatic or manual fan)</li> <li>● Advanced fan control function, e.g. fan kick, fan start delay, selectable fan operation (enable, disable, depending on heating/cooling mode, or min. and max. speed setting)</li> <li>● Fan start depending on fan coil temperature (heating) to avoid cool air while heating</li> <li>● Enabling fan output only in the 2<sup>nd</sup> stage (2-pipe/2-stage)</li> <li>● Switching fan speed from manual to automatic in the dead zone to avoid energy waste (selectable function)</li> </ul>                                                                                                                                                                                                                                                                                                                                                                                                                                                                                                                                                                                                                                                                    |
| Special functions     | <ul style="list-style-type: none"> <li>● Swap function for 2-pipe and 2-stage application by switching the 1<sup>st</sup> stage heating to 2<sup>nd</sup> stage cooling</li> <li>● In 2-stage applications, limit the number of heating or cooling sequence to one</li> <li>● Control of 6-port ball valve and for 6-port PICV, DC 0...10 V, DC 2...10 V and inverted signals DC 10...0 V, DC 10...2 V (RDG26..T)</li> <li>● Control of 6-port ball valve as changeover (On/Off – open/close signal) and PICV DC 0...10 V</li> <li>● Flow limitation function for PICV in heating and cooling mode (RDG26..T)</li> <li>● Set holiday period to reduce energy consumption during absences (holidays)</li> <li>● For 6-port PICV (RDG26..T) <ul style="list-style-type: none"> <li>– During commissioning, maximal water flow selection in l/h for heating (P260) and for cooling (P261) independently via PCT Go</li> <li>– During operation, water flow (l/h) reading via PCT Go live data function</li> </ul> </li> <li>● Selectable relay functions <ul style="list-style-type: none"> <li>– Switching off external equipment during Protection mode</li> <li>– Switching on external equipment (e.g. pump) during heating/cooling demand</li> <li>– Output status heating/cooling sequence</li> </ul> </li> </ul> |
| Inputs                | <ul style="list-style-type: none"> <li>● 3 multifunctional inputs X1, X2 and X3, selectable for: <ul style="list-style-type: none"> <li>– Window contact switches operating mode to Protection</li> <li>– Presence detector switches operating mode to Comfort</li> <li>– Sensor for automatic heating/cooling changeover</li> <li>– Switch for manual heating/cooling changeover</li> <li>– External room temperature or return air temperature sensor</li> <li>– Dewpoint sensor</li> <li>– Enable electric heater</li> <li>– Fault input</li> </ul> </li> </ul>                                                                                                                                                                                                                                                                                                                                                                                                                                                                                                                                                                                                                                                                                                                                                   |



- Supply air temperature sensor
- Coil temperature sensor
- External temperature limit
- Hotel presence detector

## Applications

The RDG2..T room thermostats support the following applications, which can be configured using the DIP switches on the rear of the unit or via the commissioning tool.

Remote configuration

Set DIP switches 1...5 to Off (remote configuration, factory setting) to select an application via commissioning tool.

Remote configuration via commissioning tool (factory setting) <ul style="list-style-type: none"> <li>• Commissioning via Siemens smartphone application PCT Go</li> </ul>	<b>ON =</b>  <b>DIP NO.: 1...5</b>
	<b>OFF =</b>  <b>DIP NO.: 1...5</b>

# Applications for fan coil systems

Applications, DIP setting, control outputs					
<ul style="list-style-type: none"> <li>2-pipe fan coil unit</li> </ul> <p>Using RDG20..T, RDG26..T</p>		<ul style="list-style-type: none"> <li>2-pipe fan coil unit with electric heater</li> </ul> <p>Using RDG20..T, RDG26..T</p>		<ul style="list-style-type: none"> <li>2-pipe fan coil unit with radiator/floor heating</li> </ul> <p>Using RDG20..T, RDG26..T</p>	
<ul style="list-style-type: none"> <li>2-pipe/2-stage fan coil unit</li> </ul> <p>Using RDG20..T, RDG26..T</p>		<ul style="list-style-type: none"> <li>4-pipe fan coil unit</li> </ul> <p>Using RDG20..T, RDG26..T</p>		<ul style="list-style-type: none"> <li>4-pipe fan coil unit with electric heater</li> </ul> <p>Using RDG20..T, RDG26..T</p>	
<ul style="list-style-type: none"> <li>4-pipe fan coil unit with PICV and 6-port ball valve as changeover</li> </ul> <p>Using RDG26..T</p>		<ul style="list-style-type: none"> <li>4-pipe fan coil unit with 6-port PICV</li> </ul> <p>Using RDG26..T</p>		<p>YHC Heating/cooling valve actuator            YH Heating valve actuator            YC Cooling valve actuator            YE Electric heater            YR Radiator valve actuator            M1 1-speed or 3-speed fan, DC 0...10 V fan            B1 Return air temperature sensor or external room temperature sensor (optional)            B2 Changeover sensor (optional)</p>	

Product No.	Control output	Fan output
RDG20..T	PWM, On/Off, 3-pos	3-speed, 1-speed, DC 0...10 V
RDG26..T	DC 0...10 V	3-speed, 1-speed, DC 0...10 V
	On/Off	DC 0...10 V

# Applications for universal systems

Applications, DIP setting, control outputs					
<ul style="list-style-type: none"> <li>Chilled/heated ceiling</li> </ul> <p>Using RDG20..T, RDG26..T</p>		<ul style="list-style-type: none"> <li>Chilled/heated ceiling and electric heater</li> </ul> <p>Using RDG20..T, RDG26..T</p>		<ul style="list-style-type: none"> <li>Chilled/heated ceiling and radiator/floor heating</li> </ul> <p>Using RDG20..T, RDG26..T</p>	
<ul style="list-style-type: none"> <li>2-stage chilled/heated ceiling</li> </ul> <p>Using RDG20..T, RDG26..T</p>		<ul style="list-style-type: none"> <li>Chilled ceiling and radiator</li> </ul> <p>Using RDG20..T, RDG26..T</p>		<ul style="list-style-type: none"> <li>Chilled and heated ceiling control with 6-port ball valve</li> </ul> <p>Using RDG26..T</p>	
<ul style="list-style-type: none"> <li>Chilled and heated ceiling control with PICV and 6-port ball valve as changeover</li> </ul> <p>Using RDG26..T</p>		<ul style="list-style-type: none"> <li>Chilled and heated ceiling control with 6-port PICV</li> </ul> <p>Using RDG26..T</p>		<p>YHC Heating/cooling valve actuator          YH Heating valve actuator          YC Cooling valve actuator          YE Electric heater          YR Radiator valve actuator          D3 Dewpoint sensor          B1 Return air temperature sensor or external room temperature sensor (optional)          B2 Changeover sensor (optional)</p>	

Product No.	Control outputs
RDG20..T	On/Off, PWM, 3-position
RDG26..T	On/Off, DC 0...10 V

# Application for heat pump systems

Applications, DIP setting, control outputs		
<ul style="list-style-type: none"> <li>Heated or cooled with compressors</li> </ul>		<ul style="list-style-type: none"> <li>Heated or cooled with compressors with electric heater</li> </ul>
<p>Using RDG20..T, RDG26..T</p>	<p>Using RDG20..T, RDG26..T</p>	
<ul style="list-style-type: none"> <li>Heated and cooled with compressors</li> </ul>		<ul style="list-style-type: none"> <li>2-stage heated or cooled with compressors</li> </ul>
<p>Using RDG20..T, RDG26..T</p>	<p>Using RDG20..T, RDG26..T</p>	
<p>N1 Thermostat Output Y10/Q1: Heating or heating/cooling Output Y20/Q2: Cooling only (heating/cooling)</p>		<p>B1 Return air temperature sensor or external room temperature sensor (optional)</p>
<p>YE Electric heaters</p>		<p>D3 Dewpoint sensor</p>
Product No.	Control output	Fan
RDG20..T	On/Off	Disabled, 1-speed, 3-speed, DC 0...10 V
RDG26..T	On/Off	Disabled, DC 0...10 V

## Type summary

For fan coil units, universal applications and compressors in DX-type equipment applications

Product no.	Stock no.	Operating voltage	Fan		Number of control outputs				
			3-speed	DC	On/Off	PWM	3-pos	DC	On/Off (3-wire)
RDG200T	S55770-T457	AC 230 V	✓	✓ <sup>1)</sup>	3	3	2	–	2
RDG260T	S55770-T458	AC 24 V or DC 24 V	✓	✓ <sup>1)</sup>	–	–	–	3	–
			–	✓ <sup>1)</sup>	2 <sup>2)</sup>	–	–	–	–

<sup>1)</sup> The terminal Y50 is used as DC 0...10 V output.

<sup>2)</sup> The output is relay On/Off.

## Accessories

Type	Product/stock no.	Datasheet
Mounting adapter for RDG2..T <sup>1)</sup>	ARG200: S55770-T438	-







<sup>1)</sup> ARG200 mounting adapter is used to wall-mount the RDG2..T where a conduit box is not available. For easier wiring, removable knockouts on all sides are available. For dimensions, see Dimensions [▶ 28].

## Ordering

When ordering, specify both product number / stock number and name: e.g. **RDG200T / S55770-T457 room thermostat**

Order valve actuators and accessories separately.









## Equipment combinations

Type of unit		Product no.	Datasheet <sup>1)</sup>
Cable temperature or changeover sensor, cable length 2.5 m NTC (3 kΩ at 25 °C)		QAH11.1	1840
Cable temperature sensor PVC 2 m, LG-Ni1000		QAP22	1831
Room temperature sensor NTC (3 kΩ at 25 °C)		QAA32	1747
Room temperature sensor LG-Ni1000		QAA24	1721
Front modules with passive temperature measurement LG-Ni1000		AQR2531ANW	1408
Strap-on temperature sensor LG-Ni1000		QAD22	1801
Condensation monitor		QXA21..	A6V10741072



On/Off and PWM actuators <sup>1)</sup>

Type of unit	Product no.	Datasheet <sup>*)</sup>
Thermal actuator (for radiator valves) AC 230 V, NC	Under development	
Thermal actuator (for radiator valves) AC 24 V, NC		
Thermal actuator AC 230 V (for small valves 2.5 mm), NO		
Thermal actuator AC 24 V (for small valves 2.5 mm), NO		



3-position actuators AC 230 V



Type of unit	Product no.	Datasheet <sup>*)</sup>
Electric actuator, 3-position (for radiator valves) AC 230 V 	SSA331..	A6V1185827
Electric actuator, 3-position (for 2- and 3-port valves/V..P45) AC 230 V 	SSC31	4895
Electric actuator, 3-position (for small valves 2.5 mm) AC 230 V 	SSP31..	4864
Electric actuator, 3-position (for small valves 5.5 mm) AC 230 V 	SSB31..	4891
Electric actuator, 3-position (for small valve 5 mm) AC 230 V 	SSD31..	4861
Electric actuator, 3-position (for valves 5.5 mm) AC 230 V 	SAS31..	4581
Rotary actuators for ball valves, 3-position 	GDB331.9E	4657
Rotary actuators for ball valves, 2 or 3-position 	GDB141.9E GDB341.9E	A6V10636150

On/Off actuators

Type of unit	Product no.	Datasheet <sup>*)</sup>
Electromotive On/Off actuator 	SFA21.. SFA71..	4863
Electromotive On/Off valve and actuator (only available in AP, UAE, SA and IN) 	MVI../MXI..	A6V11251892
Zone valve actuator (only available in AP, UAE, SA and IN) 	SUA	A6V10446174

DC 0...10 V actuators

Type of unit	Product no.	Datasheet <sup>*)</sup>
Electric actuator, DC 0...10 V (for radiator valves) 	SSA161..	A6V11858278
Electric actuator, DC 0...10 V (for 2- and 3-port valves/V..P45) 	SSC161..	A6V12681511





Type of unit		Product no.	Datasheet <sup>*)</sup>
Electric actuator, DC 0...10 V (for small valves 2.5 mm)		SSF161..	A6V12681511
Electric actuator, DC 0...10 V (for small valves 5.5 mm)		SSB161..	A6V12681511
Electromotive actuator, DC 0...10 V (for valves 5.5 mm)		SAS61..	4581
Electrothermal actuator, AC 24 V, NC, DC 0...10 V, 1 m		Under development	
Electrothermal actuator, AC 24 V, NO, DC 0...10 V, 1 m			
Rotary actuators for ball valves AC 24 V, DC 0...10 V		GDB161.9E	4567

DC 0...10 V  
actuators 6-port /  
PICV (RDG26..T)



Type of unit		Product no.	Datasheet <sup>*)</sup>
Rotary actuators for 6-port ball valves control: <ul style="list-style-type: none"> <li>• 6-port ball valve VWG41..</li> <li>• 6-port PICV VWPG51..</li> </ul> For details, see Recommended RDG actuators and 6-port valves combinations [► 11]		GDB161.9../6W	A6V12986395

Note: If RDG26.. needs to control GDB161.9E, the control signal needs to be set accordingly, see Control output configuration for 6-port valve in [Basic documentation](#).



DC 0...10 V  
damper actuators

Type of unit		Product no.	Datasheet <sup>*)</sup>
Air damper actuators DC 0...10 V, AC/DC 24 V		GQD166.1A GQD161.1A	4604
Air damper actuators DC 0...10 V, AC 24 V		GDB16..1	4634
		GLB16..1	
Air damper actuators DC 0...10 V, AC/DC 24 V		GMA16..1	4614
Air damper actuators DC 0...10 V, AC 24 V		GEB16..1	4621
Air damper actuators DC 0...10 V, AC/DC 24 V		GCA16..1	4613
Air damper actuators DC 0...10 V, AC 24 V		GBB16..1	4626
		GIB16..1	

On/Off damper actuators  
AC 230 V

Type of unit		Product no.	Datasheet <sup>*)</sup>
Air damper actuators 2-position, AC 230 V		GQD32..1	4604
		GMA32..1	4614
		GCA32..1	4613

On/Off damper actuators  
AC 24 V

Type of unit		Product no.	Datasheet <sup>*)</sup>
Air damper actuators 2-position, AC/DC 24 V		GQD12..1	4604
		GMA12..1	4614
		GCA12..1	4613

<sup>\*)</sup> The documents can be downloaded from <https://hit.sbt.siemens.com>

<sup>1)</sup> With PWM control, exact parallel run of 2 or more thermal actuators is not possible. If several fan coil units are controlled by the same room thermostat, motorized actuators with On/Off or 3-position control are preferred.

Note:

For more information about parallel operation and the max. number of actuators that can be used, refer to the data sheets of the selected actuator type and the following list:

Max. number of actuators in parallel on RDG20..T (AC 230 V):

- 6 SS..31.. actuators (3-position)
- 10 SFA.., SUA.., MVI.., MXI.. On/Off actuators
- Parallel operation of SAS31 not available

Max. number of actuators in parallel on RDG26..T (AC 24 V):

- 10 SS..61.. actuators (DC)
- 10 SFA.., SUA.., MVI.., MXI.. On/Off actuators
- 10 SAS61.. actuators (DC)
- 10 GDB161.9../6W

### Recommended RDG actuators and 6-port valves combinations

To guarantee the optimal temperature control performance, it is requested to use the following RDG260..T versions (see below) for controlling GDB161.9../6W actuators (with 6-port ball valves VWG41.. or 6-port PICV VWPG51..):

- RDG26..T with product index Z, A or higher

For applications with previous RDG product indices, GDB161.9E or competitor actuators, it is requested to check the device version compatibility in Control output configuration for 6-port valve in [Basic documentation](#).

## Mechanical design





The room thermostat consists of two parts:

- Plastic housing with electronics, operating elements, and room temperature sensor
- Mounting plate with screw terminals

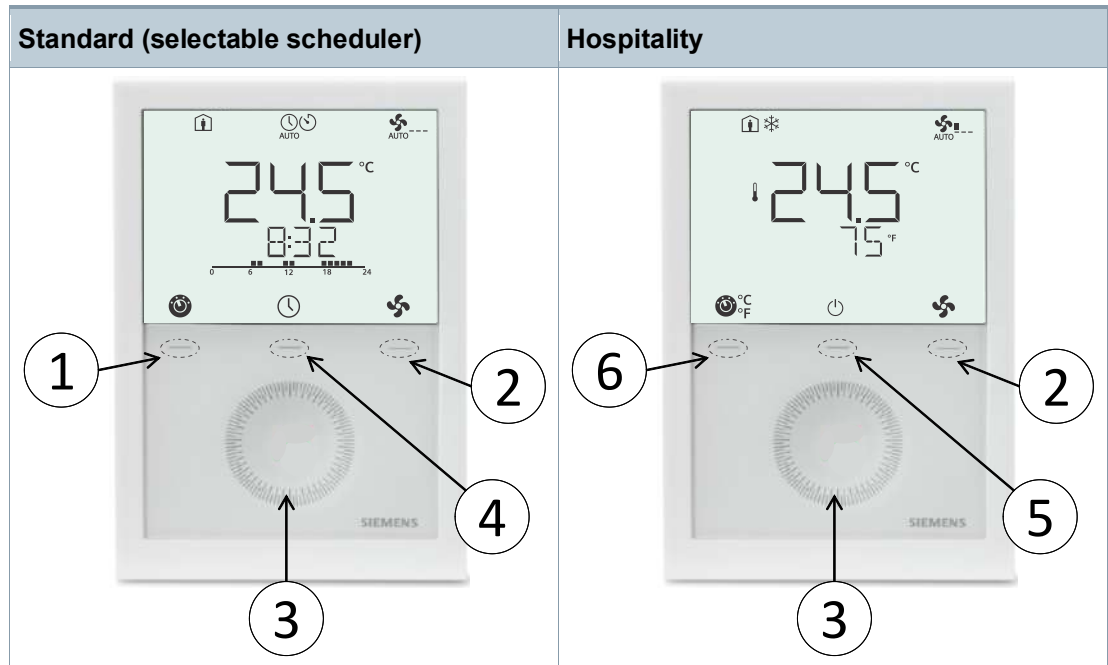
The housing engages in the mounting plate and is secured with 2 screws.

## Operation and settings



Number	Description
①	 Operating mode button/Esc
②	 Fan mode button/OK
③	Capacitive rotary knob to adjust setpoints and parameters
④	 Local schedule setting button, the schedule is enabled via P005
⑤	 Protection hospitality mode button
⑥	 Unit switching between °C and °F

## Display

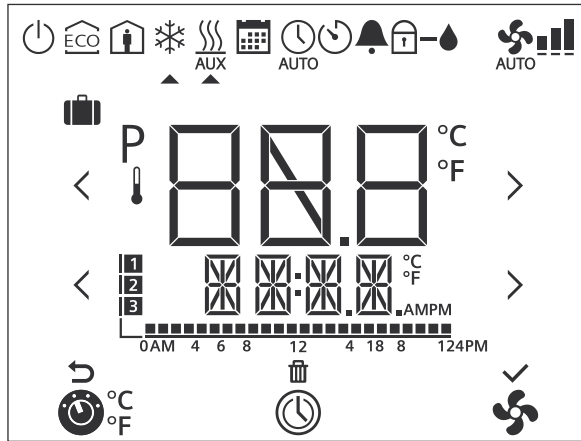

#	Symbol	Description	#	Symbol	Description
1		Operating mode selection/Unit switching	2		Scheduler
3		Fan speed selection	4		Escape
5		Delete schedule	6		Confirm parameters
7		Time bar for schedule	8		Number of schedules
9		Additional user information, such as time of day	10	<b>AMPM</b>	Morning: 12-hour format Afternoon: 12-hour format
11		Degrees Celsius or Fahrenheit	12	<b>P</b>	Parameter
13		Value with thermometer: Digits for room temperature display	14		Digits for setpoint display
15		Holiday mode	16		Protection mode
17		Economy mode	18		Comfort mode
19		Cooling mode	20		Heating mode, electric heater active
21		Heating mode	22		Manual changeover, heating/cooling mode
23		Scheduler mode	24		Auto mode
25		Temporary timer	26		Fault
27		Button lock	28		Condensation in room (dewpoint sensor active)
29		Automatic fan	30		Fan speed
					Fan speed I
					Fan speed II
					Fan speed III

Title	Document ID
Mounting instructions	RDG200T: A6V13375634 RDG260T: A6V13375640
Operating instructions	A6V11545973
Basic documentation	A6V11545892
CE declarations	A5W00120120A
RCM	A5W00120121A
Environmental product declaration	RDG200T: A5W00304666A RDG260T: A5W00304667A

Related documents such as the environmental declarations, CE declarations, etc., can be downloaded from the following Internet address:

[www.siemens.com/bt/download](http://www.siemens.com/bt/download)

Notes

Security

**⚠ CAUTION**



**National safety regulations**

Failure to comply with national safety regulations may result in personal injury and property damage.

- Observe national provisions and comply with the appropriate safety regulations.

Mounting and installation

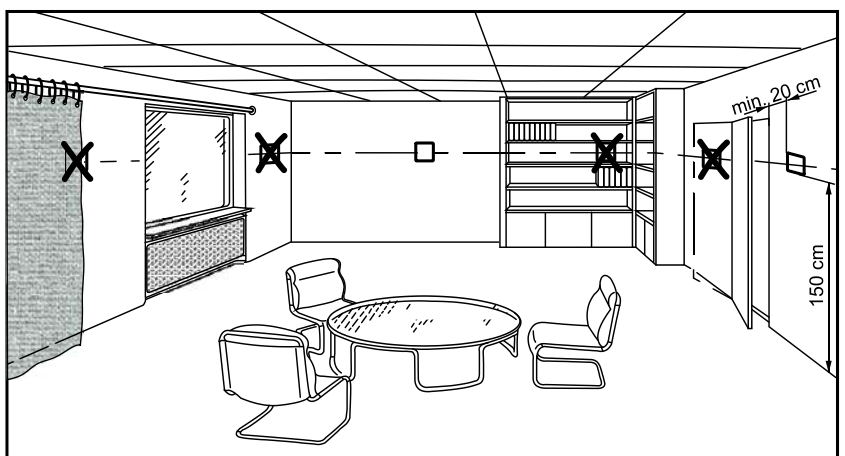

Mounting

- The devices are suitable for wall mounting.

**⚠WARNING! The device must not be mounted on a metallic surface: If no other possible installation options, use mounting adapter ARG200.**

- Recommended height: 1.5 m above the floor.
- Do not mount the devices in recesses, shelves, behind curtains or doors, or above or near heat sources.
- Avoid direct solar radiation and drafts.
- Avoid unheated (uncooled) building area such as outside walls.
- Seal the conduit box or the installation tube if any, as air currents can affect sensor readings.
- Adhere to allowed ambient conditions.
- An external room temperature sensor is recommended if above situations cannot be avoided in the installation area.

#### Wiring

- Comply with local regulations to wire, protect and earth the thermostat.

**⚠WARNING! No internal line protection for supply lines to external consumers (Q1, Q2, Q3, Yx or Yxx)! Risk of fire and injury due to short-circuits!**

- Adapt the line diameters as per local regulations to the rated value of the installed over current protection device.
- The AC 230 V mains supply line must have an external circuit breaker with a rated current of no more than 10 A.
- ⚠ Properly size the cables to the thermostat, fan and valve actuators for AC 230 V mains voltage.
- ⚠ Use valve actuators rated for AC 230 V / AC 24 V / DC 24 V depending on mains voltage.
- ⚠ Inputs X1-M, X2-M or X3-M: Multiple switches (e.g. summer/winter switch) may be connected in parallel. Consider overall maximum contact sensing current for switch rating.
- ⚠ When mains voltage is AC 230 V, SELV inputs X1-M, X2-M and X3-M use cables with min. 230 V insulation.
- Selectable relay function: Follow instructions in basic documentation A6V11545892 (Relay functions) to connect external equipment to the relay outputs.
- ⚠ Disconnect thermostat from power supply before removing from the mounting plate.

## Commissioning

---

**Applications and settings** The room thermostats are delivered with a fixed set of applications and related parameters. Select and activate the relevant application and settings during commissioning using one of the following tools:

- Local DIP switches and HMI
- Siemens smartphone application PCT Go

**DIP switches** Set the DIP switches before snapping the thermostat to the mounting plate when selecting an application via DIP switches.

Set all DIP switches to Off (remote configuration) when selecting an application via commissioning tool.

After power is On, the thermostat resets and all LCD segments light up, indicating that reset is correct. After the reset of 3 seconds, the thermostat is ready for commissioning by qualified HVAC staff.

If all DIP switches are Off, **NO APPL** displays, indicating that application commissioning via a tool is required.

**Commissioning via Siemens smartphone application PCT Go** The setting via the Siemens smartphone application Product Commissioning Tool (PCT Go) is used to set the application and parameters settings of the thermostat.

DIP switches can be either all set to Off or preset with an application. (DIP switch setting has higher priority.)

This tool allows for wireless setting of the thermostat with smartphone and read/write parameters.

The commissioning tool works directly after users scan either the antenna area of the thermostat or the NFC area on the individual package box.

In addition, users can:

- Scan the antenna area without powering on the thermostat.
- Scan the NFC area without unpacking the thermostat from the individual box.

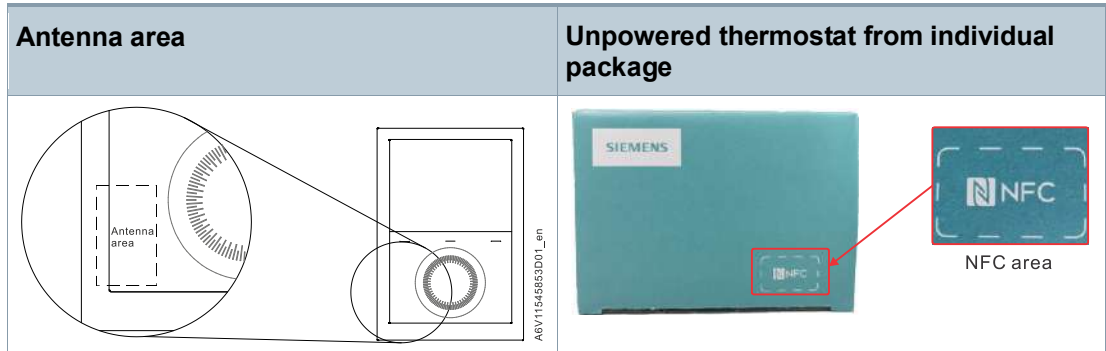

Notes

- Each time the application is changed, the thermostat reloads the factory settings for all control parameters.
- The commissioning via Siemens smartphone application PCT Go can be disabled via parameters to avoid unexpected changes of the thermostat.

Control sequence

Set the control sequence via parameter P001 depending on the application. Factory setting:

Application	Factory setting P001
2-pipe and chilled/heated ceiling, and 2-stage	1 = cooling only
4-pipe, chilled ceiling and el. heater, 6-port ball valve applications	4 = heating and cooling

Calibrate sensor

Recalibrate the temperature sensor, if the room temperature displayed on the thermostat does not match the room temperature measured (after min. 1 hour of operation). To do this, change parameter P006.

Setpoint and range limitation

We recommend to review the setpoints and setpoint ranges (P011, P013...P016, P019, P020) and change them as needed to achieve maximum comfort and save energy.

**Disposal**

	<p>This symbol or any other national label indicate that the product, its packaging, and, where applicable, any batteries may not be disposed of as domestic waste. Delete all personal data and dispose of the item(s) at separate collection and recycling facilities in accordance with local and national legislation.</p> <p>For additional details, refer to <a href="#">Siemens information on disposal</a>.</p>
-------------------------------------------------------------------------------------	-------------------------------------------------------------------------------------------------------------------------------------------------------------------------------------------------------------------------------------------------------------------------------------------------------------------------------------------------------------------------------------------------------------------------

## Open Source Software (OSS)



All open source software components used within the product (including their copyright holders and the license conditions) can be found from the website <http://www.siemens.com/download?A6V12046962>.

## Warranty

Technical data on specific applications are valid only together with Siemens products listed under "Equipment combinations". Siemens rejects any and all warranties in the event that third-party products are used.



## Technical data

Power supply (RDG20..T)	
Operating voltage (L-N)	AC 230 V +10/-15 %
Frequency	50/60 Hz
Power consumption	7 VA @ AC 230 V
Power reserve clock during power failure	Min. 20 h
 <ul style="list-style-type: none"><li>• <b>No internal fuse!</b></li></ul> External preliminary protection with max. C 10 A circuit breaker required in all cases.	

Outputs (RDG20..T)	
Fan control Q1, Q2, Q3 – N	AC 230 V
Qx rating min., max. resistive (inductive)	5 mA...5 (4) A
 <ul style="list-style-type: none"><li>• <b>No internal fuse!</b></li></ul> External preliminary protection with max. C 10 A circuit breaker required for all cases.	
 <ul style="list-style-type: none"><li>• <b>Do not connect 3-speed fans in parallel!</b></li></ul> Connect one fan directly, one relay for each speed for additional fans.	
Use for actuator control (Q1, Q2)	
<ul style="list-style-type: none"><li>• Q1 - rating min., max. resistive/inductive</li><li>• Q2 - rating min., max. resistive/inductive</li></ul>	<ul style="list-style-type: none"><li>• 5 mA...1 A</li><li>• 5 mA...1 A</li></ul>

Outputs (RDG20..T)	
Use for external equipment (Q1, Q2, Q3) <ul style="list-style-type: none"> <li>Rating min., max. resistive/inductive Qx</li> <li>Max total load current Q1+Q2+Q3</li> </ul>	<ul style="list-style-type: none"> <li>5 mA...1 A</li> <li>2 A</li> </ul>
DC 0...10 V fan control; Y50-M	SELV DC 0...10 V, max. ±5 mA
Control outputs <ul style="list-style-type: none"> <li>Y1, Y2, Y3, Y4-N</li> <li>Yx power limitation</li> </ul>	Solid state (triacs) <ul style="list-style-type: none"> <li>AC 230 V</li> <li>8 mA...1 A</li> <li>3 A fast microfuse, cannot be exchanged</li> </ul>

Power supply (RDG26..T)	
Operating voltage (G-G0) DC 24 V: Make sure to connect G to + and G0 to -	AC 24 V ±20 % DC 24 V ±2 V
Frequency	50/60 Hz
Power consumption	4 VA @ AC 24 V
Power reserve clock during power failure	Min. 20 h
 <p><b>No internal fuse!</b> External preliminary protection with max. C 10 A circuit breaker required for all cases.</p>	

Outputs (RDG26..T)	
Fan control Q1/Q2/Q3/L-N	AC 24...230 V / DC 24 V
Use for 3-speed fan control Rating min, max resistive (inductive)	AC 24...230 V: 5 mA...5 (4) A DC 24 V: 3 A
 <p><b>No internal fuse!</b> External preliminary protection with max. C 10 A circuit breaker required for all cases.</p>	
 <p><b>Do NOT connect 3-speed fans in parallel!</b> Connect one fan directly, for additional fans, one relay for each speed.</p>	
Use for actuator control (Q1, Q2) <ul style="list-style-type: none"> <li>Q1 - rating min., max. resistive/inductive</li> <li>Q2 - rating min., max. resistive/inductive</li> <li>Max total load current Q1+Q2</li> </ul>	<ul style="list-style-type: none"> <li>5 mA...1 A</li> <li>5 mA...5 (4) A</li> <li>5 A</li> </ul>
Use for external equipment (Q1, Q2, Q3) <ul style="list-style-type: none"> <li>Rating min., max. resistive/inductive Qx</li> <li>Max total load current Q1+Q2+Q3</li> </ul>	<ul style="list-style-type: none"> <li>5 mA...1 A</li> <li>2 A</li> </ul>

### Outputs (RDG26..T)



#### No internal fuse!

External preliminary protection with max. C 10 A circuit breaker required for all cases.

DC 0...10 V fan control (Y50-M)	SELV DC 0...10 V, max. $\pm 5$ mA
Actuator control (Y10-G0/Y20-G0/Y30-G0 (G))	SELV DC 0...10 V, max. $\pm 1$ mA

### Multifunctional inputs

X1-M/X2-M/X3-M

Temperature sensor input

Type	NTC 3k
Temperature range	-20...70 °C

Temperature sensor input

Type	LG-Ni1000
Temperature range	-40...70 °C

Digital input

Operating action	Selectable (NO/NC)
Contact sensing	DC 0...5 V, max. 5 mA
Insulation against mains	SELV

### Operational data

Switching differential, adjustable

Heating mode	(P051)	1 K (0.5...6 K)
Cooling mode	(P053)	1 K (0.5...6 K)

P-band Xp

Heating mode	(P050)	2 K (0.5...6 K)
Cooling mode	(P052)	1 K (0.5...6 K)

Setpoint setting and setpoint range

Comfort mode	(P011)	21 °C (5...40 °C)
Economy mode	(P019-P020)	15 °C/30 °C (OFF, 5...40 °C)
Protection mode	(P100-P101)	8 °C/OFF (OFF, 5...40 °C)

Multifunctional inputs X1/X2/X3

	Selectable (0...6 & 9...14)
--	-----------------------------

Operational data		
Input X1 default value	(P150)	1 (external temperature sensor, room or return air)
Input X2 default value	(P153)	2 ( H/C changeover)
Input X3 default value	(P155)	3 (window contact)
Built-in room temperature sensor		
Measuring range		0...49 °C
Accuracy at 25 °C		< ±0.5 K
Temperature calibration range		±3 K
Settings and display resolution		
Setpoint		0.5 °C
Present temperature value displayed		0.5 °C

Environmental conditions	
Storage	IEC 60721-3-1
Climatic conditions	Class 1K3
Temperature	-25...65 °C
Humidity	< 95 % r.h.
Transport	IEC 60721-3-2
Climatic conditions	Class 2K3
Temperature	-25...65 °C
Humidity	< 95 % r.h.
Mechanical conditions	Class 2M2
Operation	IEC 60721-3-3
Climatic conditions	Class 3K5
Temperature	0...50 °C
Humidity	< 95 % r.h.

Standards and directives	
EU conformity (CE)	<ul style="list-style-type: none"> <li>• RDG200T</li> <li>• RDG260T</li> </ul>
	<ul style="list-style-type: none"> <li>• A5W00370264A *</li> <li>• A5W00413573A *</li> </ul>
Electronic control type	2.B (micro-disconnection on operation)

Standards and directives	
RCM conformity <ul style="list-style-type: none"> <li>● RDG200T</li> <li>● RDG260T</li> </ul>	<ul style="list-style-type: none"> <li>● A5W00370267A *</li> <li>● A5W00413574A *</li> </ul>
UKCA <ul style="list-style-type: none"> <li>● RDG200T</li> <li>● RDG260T</li> </ul>	<ul style="list-style-type: none"> <li>● A5W00370268A *</li> <li>● A5W00413575A *</li> </ul>
Protection class	II as per EN 60730
Pollution class	Normal
Degree of protection of housing	IP30 as per EN 60529
Eco design and labeling directives	Based on EU directive 813/2013 (Eco design directive) and 811/2013 (Labelling directive) concerning space heaters, combination heaters, the following classes apply:
RDG20..T <ul style="list-style-type: none"> <li>● Application with On/Off operation of a heater</li> <li>● PWM (TPI) room thermostat, for use with On/Off output heaters</li> </ul>	Class I value 1 %  Class IV value 2 %
RDG26..T <ul style="list-style-type: none"> <li>● Application with On/Off operation of a heater</li> <li>● PWM (TPI) room thermostat, for use with On/Off output heaters</li> </ul>	Class I value 1 %  Class IV value 2 %
Environmental compatibility	The product environmental declaration (RDG20..T: A5W00304666A *, RDG26..T: A5W00304667A *) contains data on environmentally compatible product design and assessments (RoHS compliance, materials composition, packaging, environmental benefit, disposal).

General	
Connection terminals	Solid wires or stranded wires with wire-end sleeves 1 x 0.4...2.5 mm <sup>2</sup> or 2 x 0.4...1.5 mm <sup>2</sup>
Minimal wiring cross section on L, N, Q1, Q2, Q3, Y1, Y2, Y3, Y4	Min. 1.5 mm <sup>2</sup>

General	
Maximal wiring cross section on L, N, Q1, Q2, Q3, Y1, Y2, Y3, Y4	Max. 2.5 mm <sup>2</sup>
Housing front color	RAL 9016 white
Weight without/with packaging	
RDG200T	266 g/336 g
RDG260T	242 g/311 g

\*) The documents can be downloaded from <https://hit.sbt.siemens.com>.

Connection terminals

**RDG20..T**

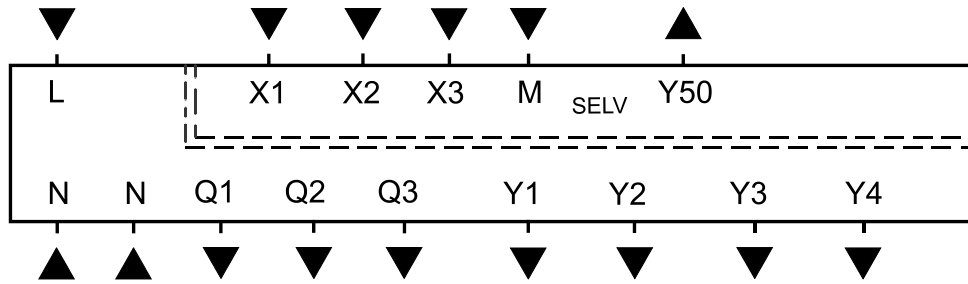

A6V13375643A00

L, N	Operating voltage AC 230 V
X1, X2, X3	Multifunctional input for temperature sensor (NTC 3k or LG-Ni1000) or potential-free switch (function can be selected via parameter)
M	Measuring neutral for sensors and switches
Q1	Control output for fan speed I AC 230 V
Q2	Control output for fan speed II AC 230 V
Q3	Control output for fan speed III AC 230 V
Q1...Q3	Also for special functions AC 230 V
Y1...Y4	Control outputs "Valve" AC 230 V (Normally open triac, for normally closed valves), output for electric heater via external relay
Y50	Control output "Fan" DC 0...10 V

**RDG26..T**

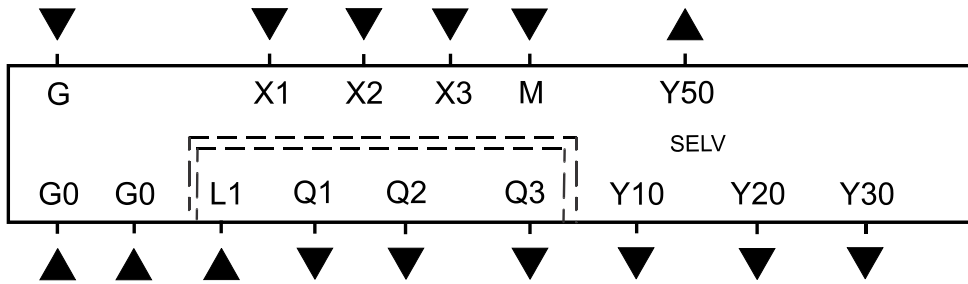

A6V13375643A01

G, G0	Operating voltage AC 24 V / DC 24 V
L1	Feed for relays AC 24...230 V
X1, X2, X3	Multifunctional input for temperature sensor (NTC 3k or LG-Ni1000) or potential-free switch (function can be selected via parameter)
M	Measuring neutral for sensors and switches
Q1 (L1)	Control output for fan speed I AC 230 V / AC 24 V
Q2 (L1)	Control output for fan speed II AC 230 V / AC 24 V
Q3 (L1)	Control output for fan speed III AC 230 V / AC 24 V
Q1...Q3 (L1)	For special functions AC 24...230 V
Y10, Y20, Y30	Control outputs "Valve" DC 0...10 V
Y50	Control output "Fan" DC 0...10 V

## Connection diagrams

---

The connection workflow is as follows:

- Select fan control type: DC, 1-speed or 3-speed fan
- Select application type, e.g. 4-pipe
- Columns V1, V2, V3, V4 show the type of the outputs (e.g. for 4-pipe: YH for heating and YC for cooling) as well the available control signals
- Select the requested control output signals (e.g. 2-pos for heating, 2-pos for cooling)
- Equipments V1, V2 etc. stands for the connected equipment on each terminal, e.g. 4-pipe with outputs of 2-pos and 2-pos, V1 (valve actuator) connects to Y1 and V2 (valve actuator) to Y2

### Notes

- "2-pos" can be used for control signal On/Off and PWM
- For universal application, fan function needs to be switched off via P350

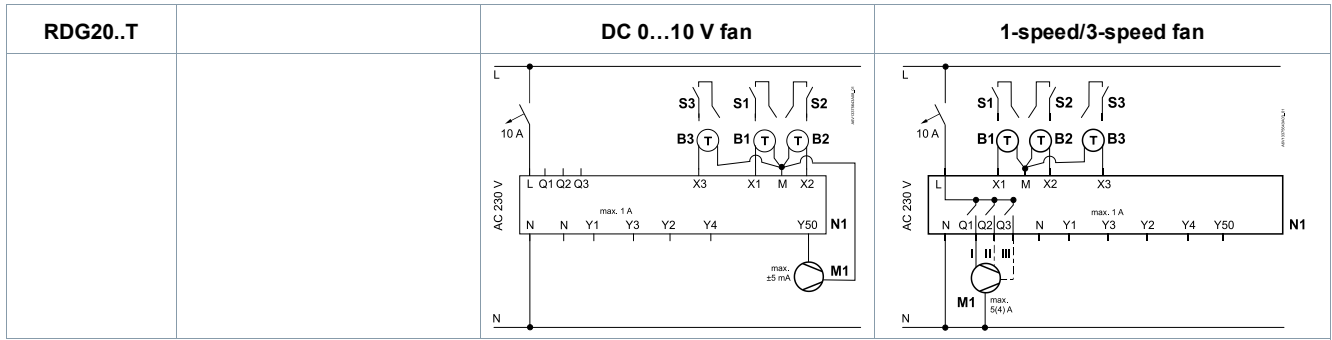

Application	Equipment	Terminals				Terminals			
	V1		Y1	Y3		Y50	Q1, Q2, Q3	Y1	Y3
<b>2-pipe</b>	<b>YHC</b>								
Control outputs:	2-pos		V1			✓	✓	V1	
	3-pos		▲ V1 ▼					▲ V1 ▼	

Application	Equipment		Terminals					Terminals				
	V1	V2	Y1	Y3	Y2	Y4	Y50	Q1, Q2, Q3	Y1	Y3	Y2	Y4
<b>2-pipe + RAD</b>	<b>YHC</b>	<b>YR</b>										
<b>4-pipe</b>	<b>YH</b>	<b>YC</b>										
<b>2-pipe/2-stage</b>	<b>YHC1</b>	<b>YHC2</b>										
Control outputs:	2-pos	2-pos	V1		V2				V1		V2	
	2-pos	3-pos	V1		▲ V2 ▼		✓	✓	V1		▲ V2 ▼	
	3-pos	2-pos	▲ V1 ▼		V2				▲ V1 ▼		V2	
	3-pos	3-pos	▲ V1 ▼		▲ V2 ▼				▲ V1 ▼		▲ V2 ▼	

Application	Equipment		Terminals					Terminals				
	V1	V2	Y1	Y3	Y2	Y4	Y50	Q1, Q2, Q3	Y1	Y3	Y2	Y4
<b>2-pipe with electric heater</b>	<b>YHC</b>	<b>YE</b>										
Control outputs:	2-pos	2-pos	V1		V2				V1		V2	
	2-pos	3-pos	V1		▲ V2 ▼		✓	✓	V1		▲ V2 ▼	
	3-pos	2-pos	▲ V1 ▼		V2				▲ V1 ▼		V2	
	3-pos	3-pos	▲ V1 ▼		▲ V2 ▼				▲ V1 ▼		▲ V2 ▼	

Application	Equipment			Terminals					Terminals				
	V1	V2	V3	Y1	Y2	Y4	Y3	Y50	Q1, Q2, Q3	Y1	Y2	Y4	Y3
<b>4-pipe with electric heater</b>	<b>YH</b>	<b>YC</b>	<b>YE</b>										
Control outputs:	2-pos	2-pos	2-pos	V1	V2		V3		✓	✓	V1	V2	V3
	2-pos	3-pos	2-pos	V1	▲ V2 ▼		V3				V1	▲ V2 ▼	V3

- N1 Room thermostat RDG20..T M1 1-speed or 3-speed fan, DC 0...10 V fan
- S1, S2, S3 Switch (keycard, window contact, presence detector etc.) B1, B2, B3 Temperature sensor (return air temperature, external room temperature, changeover sensor, etc.)
- V1, V2, V3 Valve actuators: On/Off or PWM, 3-position, heating, cooling, radiator, heating/cooling, 1<sup>st</sup> or 2<sup>nd</sup> stage YH Heating valve actuator
- YE Electric heater YC Cooling valve actuator
- K Relay YHC Heating/cooling valve actuator
- YR Radiator valve actuator YHC1/YH1/YH2/YHC2/YC1/YC2 1<sup>st</sup>/2<sup>nd</sup> stage

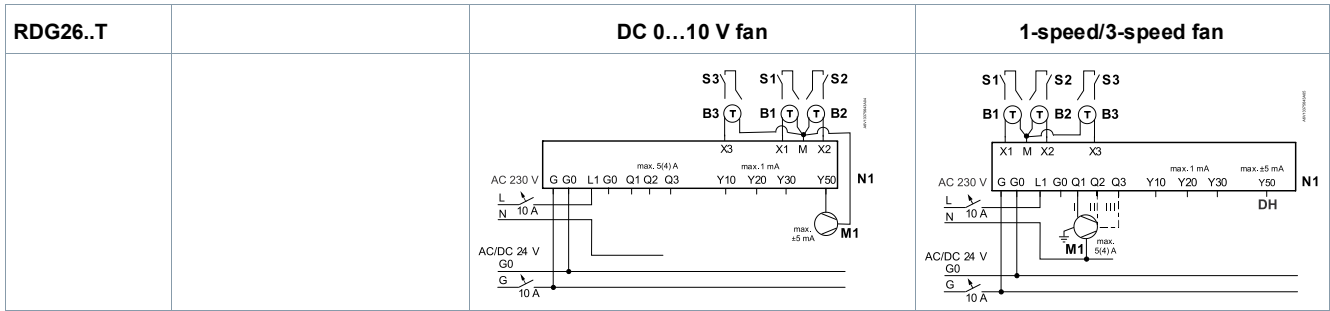

Application	Equipment	Terminals				Terminals			
	V1	Q1	Y10	Y50	Q1, Q2, Q3	Y10			
2-pipe	YHC								
Control outputs:	DC		V1						
	On/Off	V1			✓	✓			

Application	Equipment		Terminals				Terminals			
	V1	V2	Q1	Q2	Y10	Y20	Y50	Q1, Q2, Q3	Y10	Y20
2-pipe + RAD	YHC	YR								
4-pipe	YH	YC								
2-pipe/2-stage	YHC1	YHC2								
Control outputs:	DC	DC			V1	V2			V1	V2
	DC	On/Off		V2	V1					
	On/Off	DC	V1			V2	✓	✓		
	On/Off	On/Off	V1	V2						

Application	Equipment		Terminals				Terminals			
	V1	V2	Q1	Q2	Y10	Y20	Y50	Q1, Q2, Q3	Y10	Y20
2-pipe with electric heater	YHC	YE								
Control outputs:	DC	DC			V1	V2			V1	V2
	DC	On/Off		V2	V1					
	On/Off	DC	V1			V2	✓	✓		
	On/Off	On/Off	V1	V2						

Application	Equipment			Terminals				Terminals				
	V1	V2	V3	Q2	Y10	Y20	Y30	Y50	Q1, Q2, Q3	Y10	Y20	Y30
4-pipe with electric heater	YH	YC	YE									
Control outputs:	DC	DC	DC		V1	V2	V3			V1	V2	V3
	DC	DC	On/Off	V3	V1	V2		✓	✓			

- N1 Room thermostat RDG26..T M1 1-speed or 3-speed fan, DC 0...10 V fan
- S1, S2, S3 Switch (keycard, window contact, presence detector etc.) V1, V2, V3 Valves actuators:  
On/Off or DC 0...10 V, heating, cooling, radiator, heating/cooling, 1<sup>st</sup> or 2<sup>nd</sup> stage
- YE Electric heater B1, B2, B3 Temperature sensor (return air temperature, external room temperature, changeover sensor, etc.)
- YH Heating valve actuator YHC Heating/cooling valve actuator
- YC Cooling valve actuator YR Radiator valve actuator
- YHC1/YH1/YH2/YHC2/YC1/YC2 1<sup>st</sup>/2<sup>nd</sup> stage

RDG26..T		
<b>Application</b>	<b>4-pipe with 6-port PICV</b>	
<b>DC 0...10 V fan</b>		
<b>1-speed/3-speed fan</b>		
<b>Application</b>	<b>4-pipe with 6-port ball valve as changeover and PICV</b>	<b>Chilled/heated ceiling with 6-port control ball valve</b>

N2	Room thermostat RDG26..T	V3	6-port modulating control actuator
S1, S2, S3	Switch (keycard, window contact, presence detector etc.)	V4	PICV control valve
B1, B2, B3	Temperature sensor (return air temperature, external room temperature, changeover sensor, etc.)	M1	1-speed or 3-speed fan, DC 0...10 V fan

**Note:** In application "4-pipe with 6-port ball valve as changeover and PICV", Y50 can be connected with a DC 0...10 V fan.

## Dimensions

RDG2..T

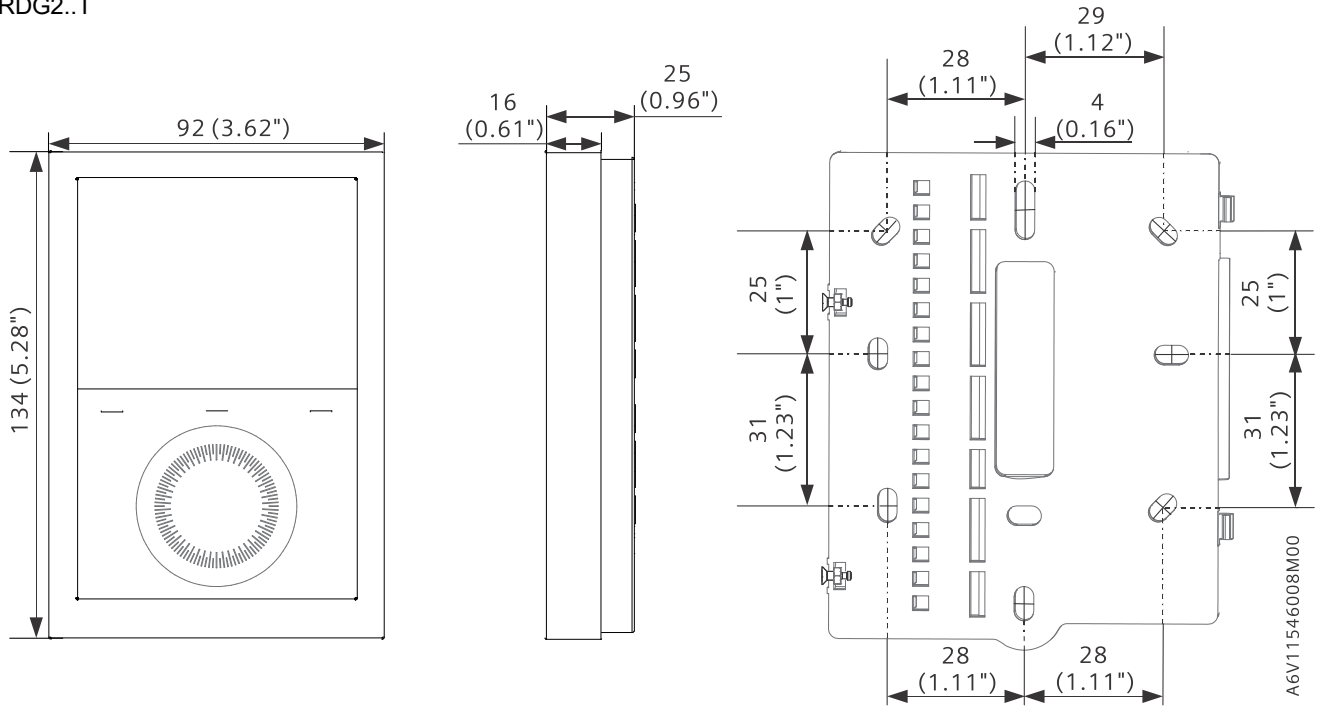

ARG200

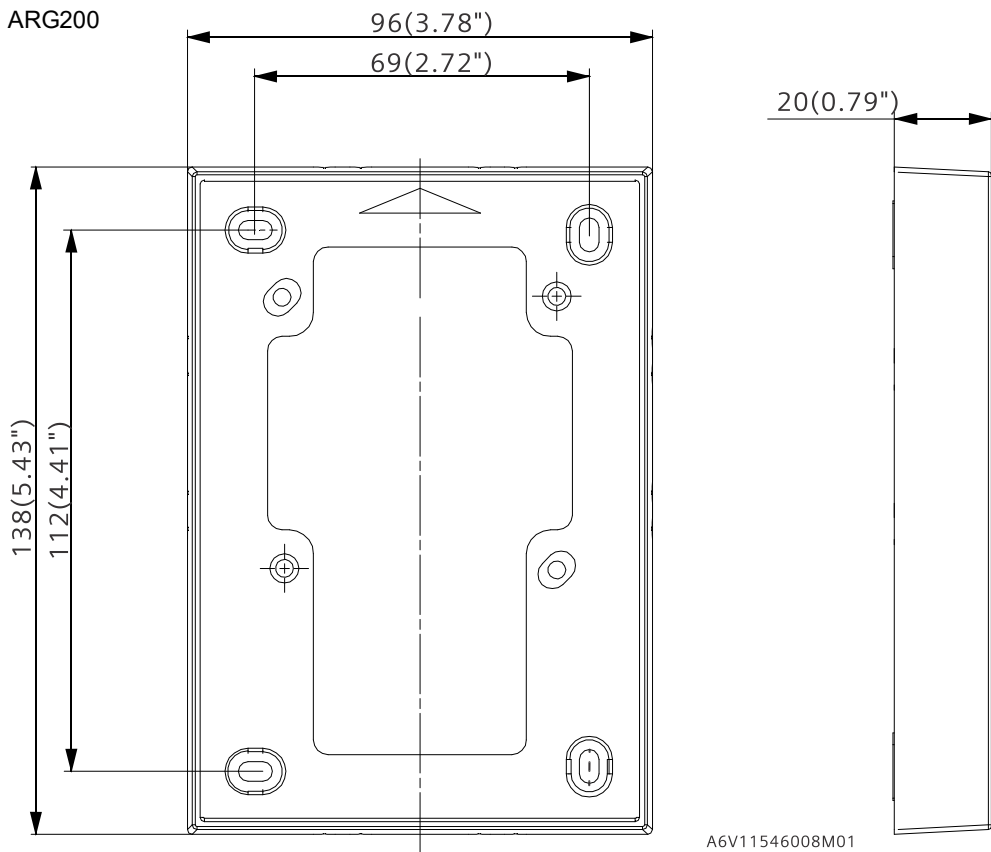

Dimensions in mm (inch)



Issued by  
Siemens Switzerland Ltd  
Smart Infrastructure  
Global Headquarters  
Theilerstrasse 1a  
CH-6300 Zug  
+41 58 724 2424  
[www.siemens.com/buildingtechnologies](http://www.siemens.com/buildingtechnologies)

© Siemens Switzerland Ltd, 2023  
Technical specifications and availability subject to change without notice.

---

Document ID    A6V13375643\_en--\_a  
Edition        2023-02-14