

Mx panel Fire Detection System

Commissioning Manual

M-167.2-SERIE-MA-EN / 11.2021

Intended purpose

This product may be used only for the applications outlined in the catalogue and in the technical description, and only in conjunction with the recommended and approved external devices and components.

This documentation contains registered and unregistered trademarks. All trademarks are the property of the respective owners. The use of this documentation does not grant you a licence or any other right to use any name, logo or label referred to or depicted herein.

This documentation is subject to the copyright of Honeywell. The content must not be copied, published, modified, distributed, transmitted, sold or changed without the express prior written permission of Honeywell. The information contained in this documentation is provided without warranty.

Safety-related user information

This manual includes information required for the proper use of the products described.

In order to ensure correct and safe operation of the product, all guidelines concerning its transport, storage, installation, and mounting must be observed. This includes taking the necessary care when operating the product.

The term 'qualified personnel' in the context of the safety information included in this manual or on the product itself designates:

- project engineers who are familiar with the safety guidelines concerning fire alarm and extinguishing systems.
- trained service engineers who are familiar with the components of fire alarm and extinguishing systems and the information on their operation as included in this manual.
- trained installation or service personnel with the necessary qualifications for carrying out repairs on fire alarm and extinguishing systems, or who are authorised to operate, earth and label electrical circuits and/or safety equipment/systems.

Symbols

The following information is provided in the interests of personal safety and to prevent damage to the product described in this manual and all equipment connected to it.

Safety information and warnings to prevent hazards endangering the life and health of users and maintenance personnel, as well as causing damage to the equipment itself, are indicated by the following pictograms. Within the context of this manual, these pictograms have the following meanings:



Warning - designates risks for man and/or machine. Non-compliance will result in risks to man and/or machine. The level of risk is indicated by the word of warning.



Note - important information on a topic or a procedure and other important information.



Standards and guidelines - observe configuration and commissioning information in accordance with the national and local requirements.

Dismantling



In accordance with Directive 2012/19/EU (WEEE), after being dismantled, electrical and electronic equipment is taken back by the manufacturer for proper disposal.

© Honeywell International Inc./technical changes reserved!

This documentation is subject to copyright law and, as per Sections 16 and 17 of the German Copyright Act (UrhG), may be neither copied nor disseminated in any other way. Any infringement as per Section 106 of the UrhG may result in legal action.

Contents

1 General / Application 5

 1.1 DETECTION SYSTEM LIMITS..... 5

 1.2 Associated Documents..... 5

 1.3 Technical details 5

2 Overview..... 6

 2.1 FRONT PANEL CONTROLS AND SIGNALS 7

 2.2 FRONT PANEL LED INDICATIONS 8

 2.3 USER INTERFACE DESCRIPTION 9

 2.3.1 Description of using the keyboard to enter data in the programming folders:..... 9

 2.3.2 Normal condition 10

 2.3.3 Pre-alarm condition..... 11

 2.3.4 Alarm condition..... 12

 2.3.5 Zone fault event condition 13

 2.3.6 System fault event condition..... 14

 2.3.7 Condition with alarm events from a zone in testing..... 14

3 PROGRAMMING MENU 15

 3.1 Programming menu 16

 3.2 Programming - System menu 16

 3.2.1 Programming – system - system type..... 17

 3.2.2 Programming – system - system address 17

 3.2.3 Programming – system – line 17

 3.2.4 Programming – system - timings..... 18

 3.2.5 Programming - system - password..... 20

 3.2.6 System programming: installation..... 20

 3.2.7 Relay 20

 3.3 Programming – points 21

 3.3.1 Detectors MAIN TAB (SW type ID and text associated with the detector)..... 21

 3.3.2 Detector PROGRAM TAB (programming of CBE equations, zone association) 22

 3.3.3 Detector OPTION TAB (programming of verification, sensitivity, day/night, tracking and LED flashing)..... 23

 3.3.4 Detector EDIT TAB
(for all sensors which allow points to be removed and copied from...to...) 24

4 Example of programming a CLIP sensor with SW TYPE ID “OMNI” MI-PTSE-S2, MI-PTIR-S2..... 25

 4.1.1 Main TAB (programming type ID and text associated with the sensor)..... 25

 4.1.2 Program TAB (programming of CBE equation, zone association) 25

 4.1.3 Option TAB (programming of check, al level, day/night, tracking and LED flashing) 25

 4.2 Example of programming a CLIP sensor with SW TYPE ID “PINN” MI-LZR-S3I..... 26

 4.2.1 Main TAB (programming of type ID and text associated with the sensor)..... 26

 4.2.2 Program TAB (programming of CBE equation, zone association) 26

 4.2.3 Option TAB (programming of check, al. level, day/night, tracking and LED flashing) 26

5 MODULES 27

 5.1 INPUT MODULES 27

 5.1.1 TAB programming of SW type ID and reading associated with the module 27

 5.1.2 Programming TAB (programming of CBE equation, zone association) 27

 5.1.3 Option TAB (programming tracking and LED flashing)..... 28

 5.1.4 Edit TAB..... 28

 5.2 OUTPUT MODULES..... 29

 5.2.1 TAB or option (programming disabled silencing, test enabling and LED flashing) 29

6 Auto-learn - automatic detection of installed devices..... 30

7	Summary of SW type ID for modules	32
7.1	INPUT MODULES	32
7.1.1	INPUT MODULES FOR GENERAL SERVICES	33
7.2	OUTPUT MODULES.....	33
7.2.1	OUTPUT MODULES FOR GENERAL SERVICES.....	34
8	GROUPS programming menu.....	35
8.1	Main TAB (programming the maximum limit of the direct-action group number).....	35
8.2	Program TAB (programming type, CBE and cross alarm).....	36
8.2.1	CBE equation.....	36
8.3	HIGH AND LOW SENSITIVITY GROUPS.....	37
9	ZONE programming menu	38
9.1	Programming - CONFIGURATION menu.....	39
9.1.1	CPU tab (programming CPU and loops).....	39
9.1.2	RPT tab (programming for CAN bus repeater)	39
9.1.3	PRN tab (programming printer interface).....	39
9.1.4	LCD tab (programming of repeaters).....	39
9.2	Programming – delete configuration	40
10	UTILITY MENU.....	40
10.1	Parameters.....	41
10.1.1	Local parameters.....	41
10.1.2	Special parameters	42
11	UTILITY - history log	44
12	UTILITY - VIEW/MODIFY STATUS	46
12.1	UTILITY – ACTIVE MODULE LIST.....	48
12.2	UTILITY - FIRMWARE version.....	49
12.3	Firmware update.....	49
13	DISABLE MENU.....	49
14	TEST MENU.....	52
15	Appendix A – CONTROL-BY-EVENT EQUATION	53
15.1	Programming examples.....	59
15.2	Appendix B: Software TYPE ID for MODULES.....	60

1 General / Application

The fire alarm control panels MA-1000, MA-2000 and MA-8000 may only be commissioned by trained personal with training specific to this FACP.

It is assumed that the user of this manual has completed a training course and that he knows the applicable rules that are in force.

- MA-1000 basic equipment panel has one loop detection line.
- MA-2000 basic equipment panel has two loop detection lines.
- MA-8000 basic equipment panel has four up to eight loop detection lines. One MA-LIB2 card will add two loops to basic equipment MA-8000. Up to two cards can be added to the MA-8000 to provide a maximum extension of eight loops in the same cabinet.

1.1 DETECTION SYSTEM LIMITS

An alarm or fire detection system can be very useful for providing a prompt warning of any dangerous events such as fires. In some cases, it can automatically manage events (transmit messages for room evacuation, automatic fire-extinguishing, CCTV system interface, access route or door blockage, automatic warning to authorities, etc.), but it does not ensure protection against damage to property.

In addition, systems may not operate properly if they are not installed and maintained according to the manufacturer's instructions.

1.2 Associated Documents

Part No.	Description
M-167.1-MA1000-EN	Installation Manual MA-1000
M-167.1-MA2000-EN	Installation Manual MA-2000
M-167.1-MA8000-EN	Installation Manual MA-8000
M-167.3-SERIE-MA-EN	Operation Manual MA-1000, MA-2000, MA-8000
M-167.4-SERIE-MA-EN	Quick Start Guide MA-1000, MA-2000, MA-8000
M-167.5-SERIE-MA-EN	Configuration tool MA-1000, MA-2000, MA-8000
M-167.6-MA-LCD7-EN	Operating and Installation Manual MA-LCD Repeater

1.3 Technical details

MA-1000, MA-2000, MA-8000: fire detection panels constructed in accordance with the standards **EN 54-2**, and **EN 54-4**.

Multi-processor system, 7"/17.78 cm LC display (800 x 480 mm with backlight), 256-colour touch-screen

- The system and all its components must be installed in an environment with the following conditions:
 - Temperature: -5°C ... +40°C.
 - Humidity: 10% ... 93% (non-condensing).
- Peripheral devices (sensors, etc.) which are not perfectly compatible with the control unit may cause damage to the control unit or cause the system to malfunction at any time. It is therefore essential to only use material which is guaranteed by HONEYWELL and is compatible with its control units.
- This manual refers to functions available in the software version indicated on the cover.



Please consult HONEYWELL Technical Service if in any doubt.

2 Overview

MAx panels are a 64 loop network (node-to-node max. distance: 500 m) with max. 128 loop field devices.

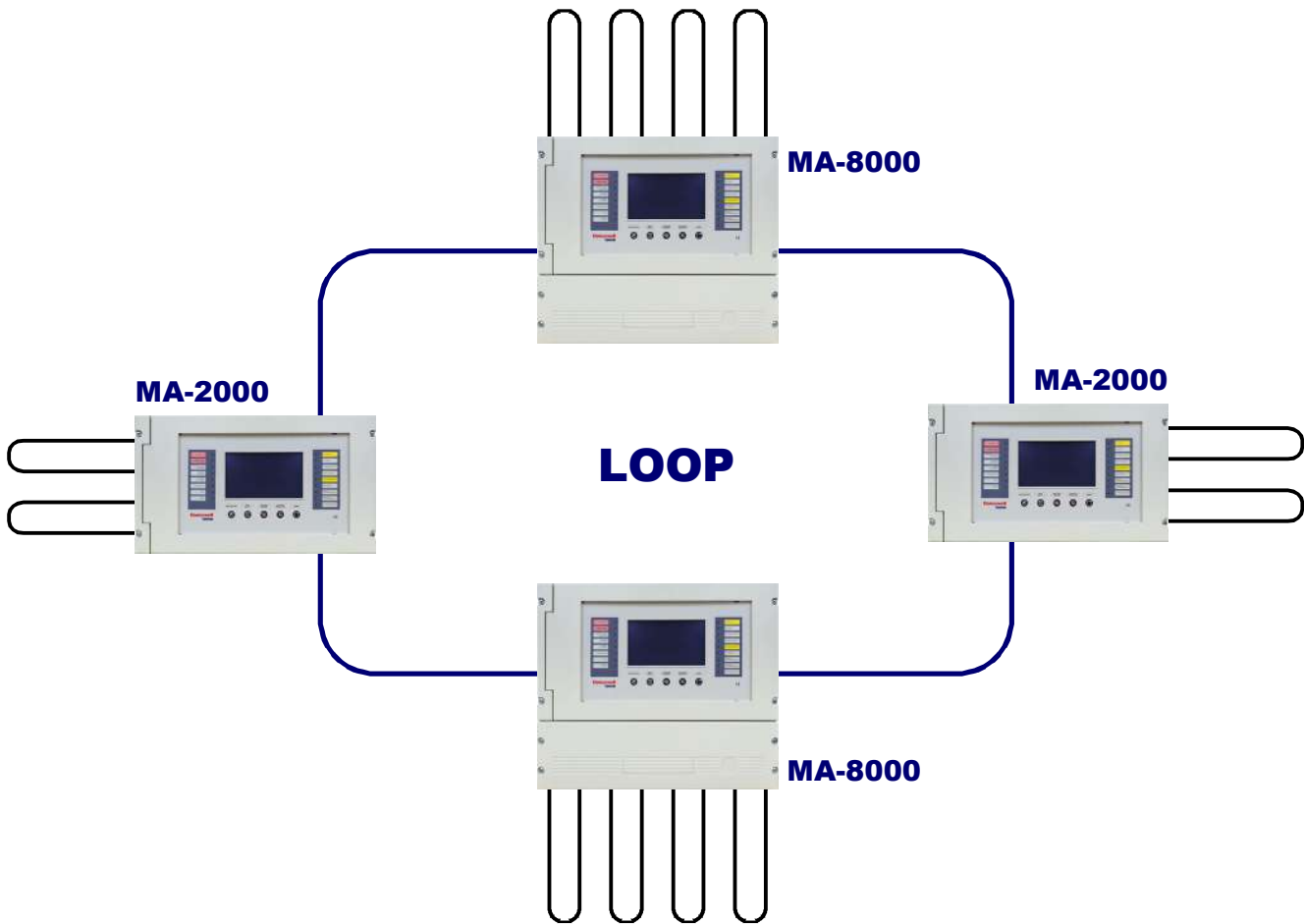

DEFINITIONS

LINE: physical wiring where sensors, addressable manual call points, sirens, addressable input and output modules are connected.

POINTS: they are the addressable sensors and modules that can be connected to lines.

HARDWARE ADDRESS: the device's physical address (start address for multi-module devices) on the loop. On CLIP devices it is set via the rotary switches or dipo-switches on the addressable device. It is possible to assign addresses from 1 to 99 on loops programmed in CLIP mode.

SOFTWARE TYPE: an identifier identifying the type of device behaviour. It can have different meanings depending on the model or device type-hardware. It may indicate device behaviour (e.g., "activates for each fault") or it may indicate the type of cabling (e.g., double balancing, free contact output, etc.)

ZONES: are sets of points in the same physical area. As stated in EN 54-2, they are used as basic indications to identify the position of an event.

- MA-1000 up to 150 soft Zones.
 - MA-2000 and MA-8000 up to 2000 soft Zones both in a standalone or system in network configuration.
- A maximum of 50 points can be associated with each zone.

GROUPS: A group is a set of software devices that can be used to program associations between inputs and outputs, and perform actions triggered by input or alarm events.

- 400 groups in a stand-alone configuration.
- 1600 groups in 128 loop network configuration.

There is no limit on the number of points in groups.

2.1 FRONT PANEL CONTROLS AND SIGNALS



Buttons with dedicated functions

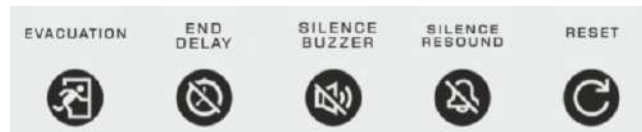

EVACUATION: Command for activating the siren output and all output modules programmed with type SW = SND in the absence of alarms and faults. A **level 2 password** is required to activate this function.

END DELAY:

This button is active only in the event of an alarm if the immediate activation of the sounder outputs has been excluded in the exclusion menu. The panel delays the activation of the abovementioned outputs for the programmed times. During the delay time, the active delay LED flashes and it is possible to reset the current delay via the End Delay button.

SILENCE BUZZER:

By pressing this button, the operator can silence the panel buzzer. This allows the user to perform a RESET.

SOUNDER ON/OFF SILENCE: A level 2 password is required for this function.

The following devices are activated in the event of an alarm:

- Sounder output
- Output modules programmed with SW type ID=**SND**
- The output modules activated for CBE associations

SILENCE RESOUND:

By pressing this button, you can deactivate the following devices:

- Siren output
- Output modules programmed with type ID **SND and** enabled for silencing
- All output modules activated for CBE associations and enabled for silencing

Pressing this button again will reactivate:

- Siren output
- Output modules programmed with type ID **SND**
- All the output modules deactivated in the previous silencing

RESET:

This function **requires a level 2 password**. Pressing this button clears alarms and faults from the memory. It deactivates the sounder and turns off all light signals of sensors in the alarm.

FUNCTION BUTTONS on the LCD TOUCH SCREEN:

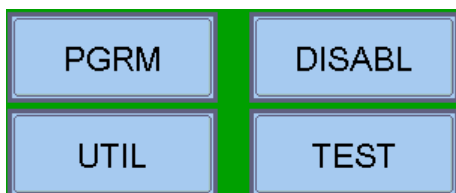

These virtual buttons are displayed at the bottom of the LCD screen. They activate the corresponding functions. These functions change according to the selected menus.

Example: in the **system status display**, these buttons allow access to the Programming, Utilities, Disablements or Test menus.

Buttons to use during PROGRAMMING or to insert the PASSWORDS



ARROWS: they are used to make some selections



By pressing and holding one of these buttons for more than a second, you get automatic repetition.



ENTER: after making a selection, this confirms the entered data.



ESCAPE: "Back", this is the menu exit function.

2.2 FRONT PANEL LED INDICATIONS

ALARM
PREALARM
REMOTE ALARM ACTIVATED
SILENCE SOUNDER
DELAY ACTIVATED
EVACUATION
TEST
POWER

ALARM (red):

It flashes if there is at least one device in alarm status and it has not been recognised yet. It is permanently on if all alarm events have been recognised.

PREALARM (red):

It flashes if there is at least one device in pre-alarm status and it has not been recognised yet. It is permanently on if all pre-alarm events have been recognised.

REMOTE ALARM ACTIVATED (red):

It is permanently on if the output to the fire alarm transmission devices (telephone dial) has been activated.

SILENCE SOUNDER (yellow):

It is on after the sounder silencing command has been performed.

DELAY ACTIVATED (yellow):

It is on if the immediate output activation has been disabled; this applies to type C (sounder output) and type E (alarm transmission via telephone dial) outputs. When this delay is activated, in the event of an alarm the system delays the abovementioned outputs for the programmed times. During the delay time the LED flashes and it is possible to reset the current delay via the “reset delay” button with user level 1 authorisation.

EVACUATION (yellow):

It is on after the evacuation function has been activated.

TEST (yellow):

It is on during the zone walk test.

POWER (green):

It is permanently on if the control unit is powered (230 V AC or battery charger).

FAULTS
SYSTEM
POWER SUPPLY
EARTH FAULT
DISABLEMENTS
SOUNDER
FAULT TRANSMISSION
ALARM TRANSMISSION
EXTINGUISHING

FAULTS (yellow):

It flashes if there is at least one fault of any type and it has not been recognised yet. It is on if all faults have been recognised.

SYSTEM (yellow):

It is on if there is at least one system fault (watch dog, CRC memory error, etc.).

POWER SUPPLY (yellow):

It is on if there is a power supply fault.

EARTH FAULT (yellow):

It is permanently on if the loop/main positive or negative are earthed.

DISABLEMENTS (yellow):

It is on if there is at least one zone or point disabled in the system.

SOUNDER (yellow):

It is on if the siren output is disabled. It flashes if the siren output is in fault condition.

FAULT TRANSMISSION (yellow):

It is on if the fault transmission output is disabled (telephone dial). It flashes if the fault transmission output is in fault condition.

ALARM TRANSMISSION (yellow):

It is on if the alarm transmission is disabled (telephone dial). It flashes if the alarm transmission output is in fault condition.

EXTINGUISHING (yellow):

It is on if the output towards the automatic fire-fighting system (UDS) is disabled. It flashes if the fire-fighting control output is in fault condition.

2.3 USER INTERFACE DESCRIPTION

Functions and access levels

Functions	EN 54 level	Factory default password
Alarm and faults display	Level 1	none
Alarm and faults recognition	Level 1	none
Delay reset (appropriate button)	Level 1	none
Excluded zones/points display	Level 1	none
Exclusions menu	Level 2	22222
Test menu	Level 2	22222
Utility menu	Level 3	33333
Programming menu	Level 3a	44444

2.3.1 Description of using the keyboard to enter data in the programming folders:

Use the arrows **◀ ▶** to enter the adjacent folders (displays).
 Use the arrows **▲ ▼** to scroll through the fields inside the folder (the selected field is displayed with the characters in REVERSE).
 If the folder has an index field, the first two function buttons appear and can be used for scrolling.
 The selected field can be changed by making an entry in editing mode using the enter button **✓**.
 There are different editing modes depending on the type of data:

- **Text entry (CBE, labels associated with devices, zones, etc.)**
 Use the keyboard displayed on the touch screen to enter alphanumeric characters.
- **Alphanumeric keyboard displayed on the touch screen:**
 This keyboard will be available on the touch screen when a programmable text needs to be edited:

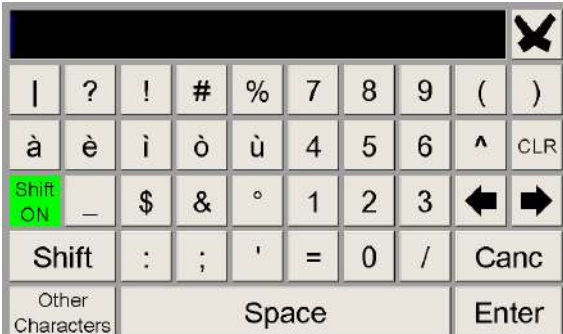

Selections (TYPE ID, YES, NO, etc.): press ENTER and use the arrows **▲ ▼** to scroll through all the selectable labels in sequence.

The parameter is saved using the enter button **✓**.
 If you do not want to save the changes, use the escape button **✕**.
 To exit the folder system, use the escape button **✕**.

To enter passwords, when they are requested, use the numeric keyboard that appears on the screen. Confirm the entered password by pressing the **ENTER** button.

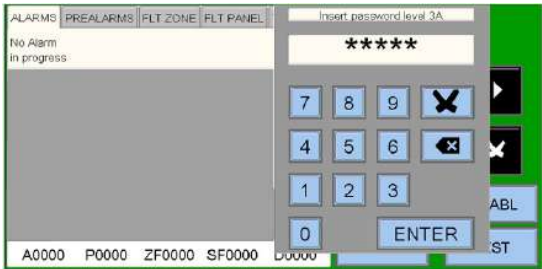

If an invalid password is entered, the following message will be displayed: **"Invalid password! xxxxx"** where **"xxxxx"** is a five-character code.

If the programmed password has been forgotten, it can be obtained from **Honeywell technical service** by providing this code.

2.3.2 Normal condition

The following screen is displayed when the control panel is in **normal condition**.

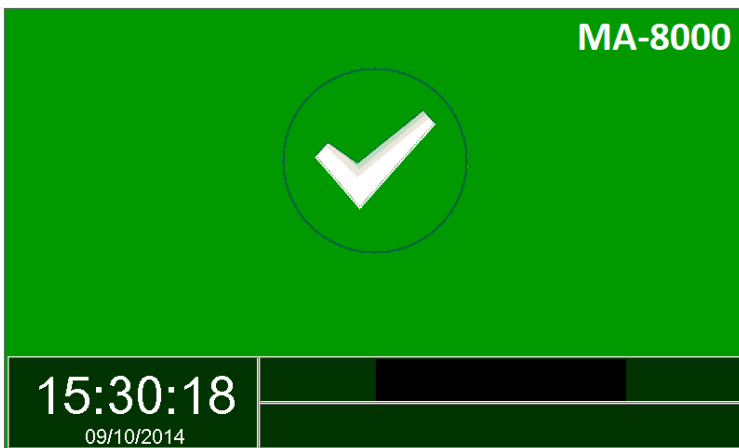



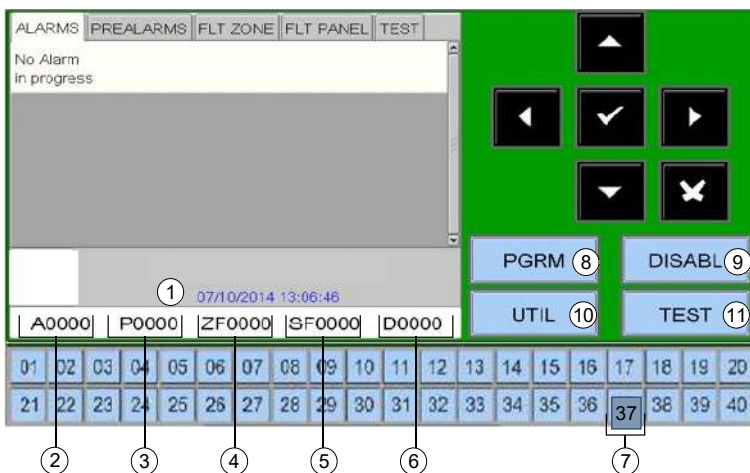

If you tap on the screen, the following screen is displayed.



①	Date - time	
②	Alarm zones counter	
③	Pre-alarm zones counter	
④	Fault zones counter	
⑤	System faults counter	
⑥	Disabled zones counter	
⑦	Virtual zone LED - zonal indication: Green = OK Dark Blue = TEST Red = FIRE Light Blue = Disablement Yellow = FAULT	
⑧	Function associated with PGRM key input of the program menu	→ refer to Programming menu
⑨	Function associated with DISABLE key input of the disable menu	→ refer to Disable menu
⑩	Function associated with TEST key input of the test menu	→ refer to Test menu
⑪	Function associated with UTIL key input of the utility menu	→ refer to Utility menu

Icons that indicate the panel conditions

-  → The icon appears if there are no alarms or faults.
-  → If there are **pre-alarms** the alarm clock icon is displayed.
-  → If there are **alarms** the fire icon is displayed.
-  → If there are **faults** this icon is displayed.



The alarm state overrides all other event types if both alarms and faults are present.

2.3.3 Pre-alarm condition

The following screen appears when the control panel is in the zone pre-alarm condition:

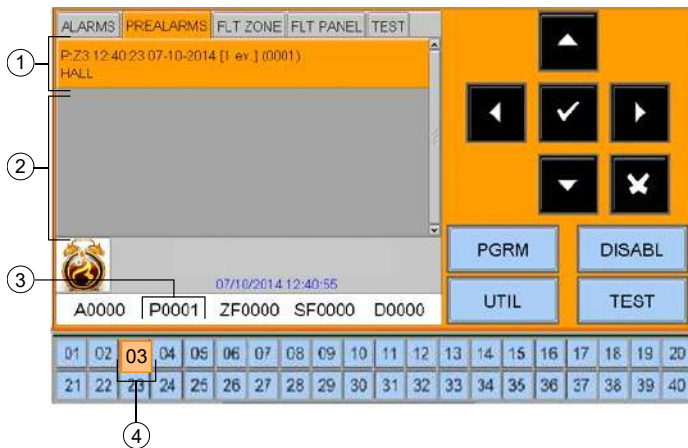

- ①
 - First zone in pre-alarm
 - Time, date, progressive event
 - Programmed text for the zone
- ② Any subsequent zones in pre-alarm
- ③ Zone counter in pre-alarm
- ④ Zone virtual LED on



Use the arrow buttons ▲ ▼ to scroll through the list of pre-alarm zones. By pressing the enter button ✓ you will access the list of points in the pre-alarm of the selected zone; by using the arrow buttons ▲ ▼ you can scroll through the list of alarm devices.

- ① Zone view window
- ② Pre-alarm device
- ③ Text programmed for the device
- ④ Zone virtual LED on

2.3.4 Alarm condition

The following display appears when the control unit is in the zone alarm condition:

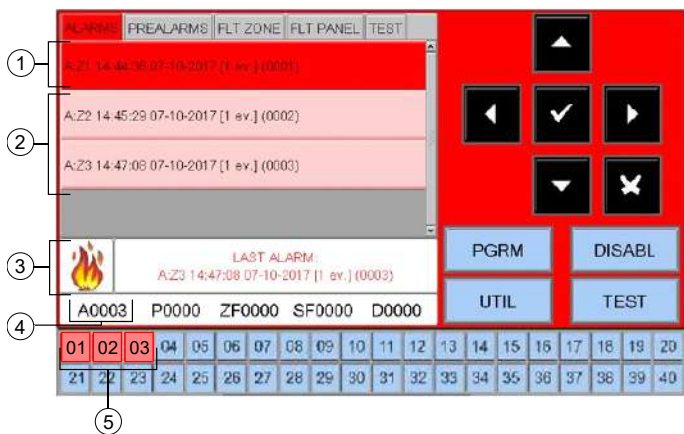

Using the arrow buttons ▼ you can scroll through the list of the zones containing faults.
By pressing the enter button ✓ you can access the list of points in alarm of the zone selected on the display; by using the arrow buttons ▲ ▼ you can scroll through the list of the devices in alarm.

- ① **FIRST ZONE IN ALARM STATUS** → date and time + event number ID → text for the zone
- ② If more zones are in alarm status: **TWO ZONES IN ALARM STATUS**
- ③ **LAST ZONE IN ALARM STATUS** → date and time + event number ID
- ④ Counter for zones in alarm status
- ⑤ Zone virtual LED on

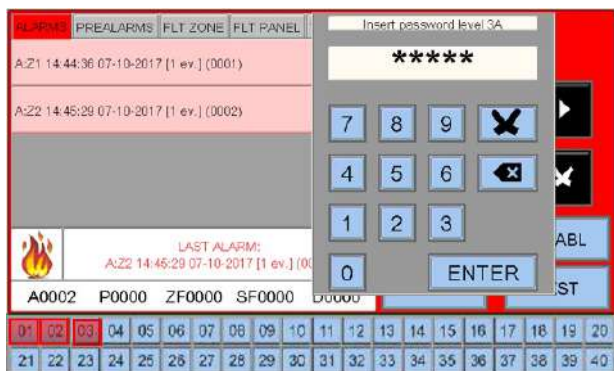

Device in alarm status
D = detector
M = module

Text programmed for this device



Alarm display in stand-by condition

2.3.5 Zone fault event condition

The following display appears when the control panel is in zone fault condition. Fault events are also initially displayed for the zone.

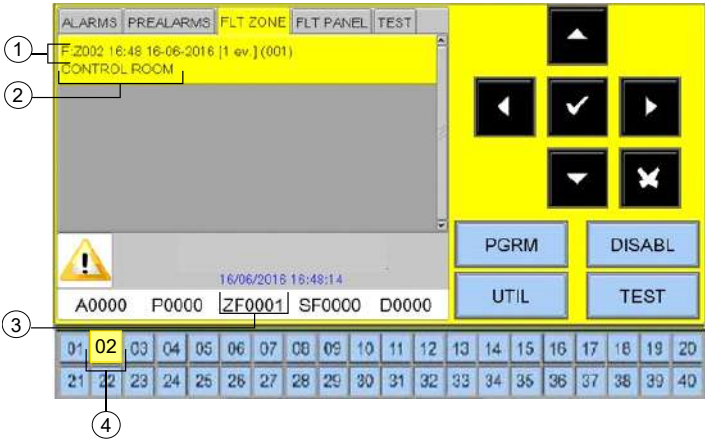

- ① Zone with fault events
- ② Text programmed for this zone
- ③ Counter for faulty zones
- ④ Zone virtual LED on

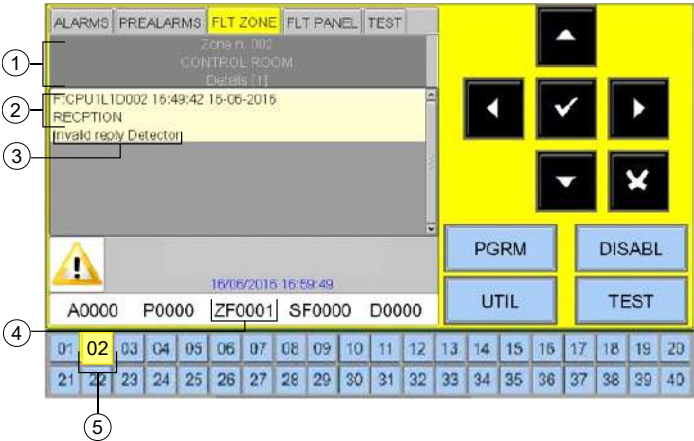

Pressing on the escape button  or leaving the keypad inactive for 30 seconds will allow you to return to the list of faulty areas.

- ① Detail of the device in fault condition
- ② Text programmed for the device
- ③ Fault type description
- ④ Counter for faulty zones
- ⑤ Zone virtual LED on



Fault display in stand-by condition

2.3.6 System fault event condition

The fault events relevant to the panel are defined as “system faults” (e.g., drained battery, no mains, etc.). The system faults are displayed with the maximum level of detail.

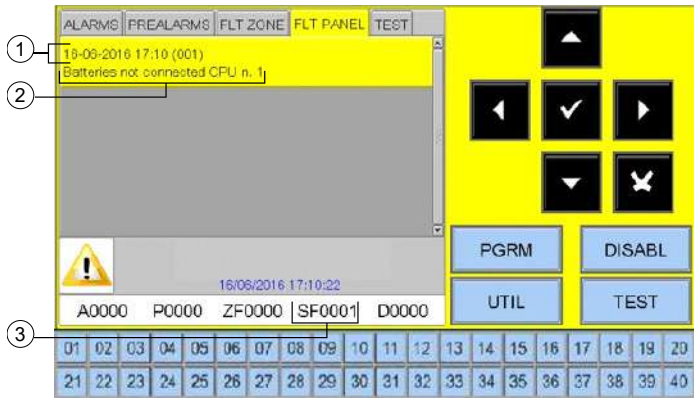

Using the arrow buttons ▲ ▼ you can scroll through the list of system faults.

- ① Date and time of the event
- ② Description of the system fault event
- ③ Counter for system faults

2.3.7 Condition with alarm events from a zone in testing

When a zone is in testing, the display appears as follows:



- ① Date and time of the event
- ② Alarm event from zone in testing
- ③ Zone virtual LED on

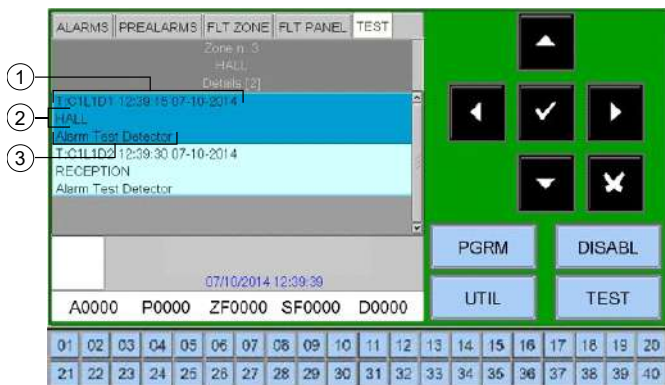

By first pressing the enter button ✓ you can display the list of devices with an indication of the point name. The details are shown in the figure.

Using the arrow buttons ▲ ▼ you can scroll through the list of tested devices in the zone.

- ① Detail of the device in alarm condition
- ② Text programmed for the device
- ③ Event description

3 PROGRAMMING MENU

RECOMMENDED SEQUENCE FOR PANEL PROGRAMMING

The following operation sequence is recommended the initial programming of the control unit in order to prevent mistakes and subsequent loss of time.

The details of each operation are provided in the following pages.

Wire the control unit lines and perform the appropriate tests as described in the installation manual before connecting the control unit to the power supply.

Make some copies of the programming sheet and record the necessary information for ALL sensors, modules, software zones, CBE and groups.

- In the Programming menu, select the System option.
- Select the line number and program the type of connection which has been used: open or loop.
- In the Programming menu, select Point programming.
- Select the auto-learn points and press the enter button, then enter the number of lines for which the procedure needs to be started.
- This will mean that all the devices installed on the lines will be recognised and loaded in the control unit memory according to their TYPE ID and with the default data.
- At the end of the procedure, check that the devices detected by the control unit during the auto-learn are those really installed, then confirm.
- This will record all data in the panel memory. The user can edit and modify the recorded data at any time.
- From the Point programming menu, select Detectors.
- Assign the detector to the appropriate zone.
- Program the detector CBE (control by event).
- From the Point programming menu, select the Modules option.
- Program the software type ID (if it is different from the default value assigned).
- Assign the module to the appropriate zone.
- Program the module CBE (control by event).

When these programming steps are complete, the control unit is ready to manage the alarm system.

Details in addition to those mentioned can be added, such as a text description for each detector, module or zone.

For further information or a description of specific parameters refer to the following paragraphs.

3.1 Programming menu

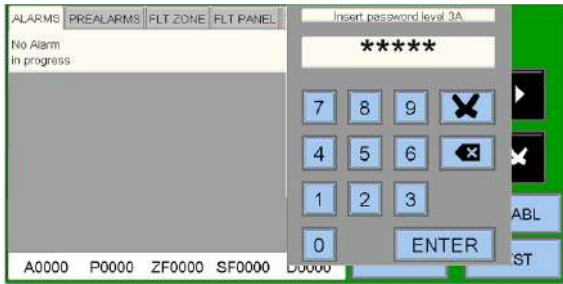

By pressing the “PGRM” button you can access the programming menu to configure the system or make changes to the programming.

To access the Programming menu, you must enter a level 3A password (44444 is the default password)

To enter the password, use the keyboard that appears on the screen and press ENTER.

The following screen is displayed



Refer to section:

- System
- Points
- Groups
- Zones
- Program
- Delete Programming

3.2 Programming - System menu

By selecting “System”, you can configure the system parameters that are valid for the whole control unit.

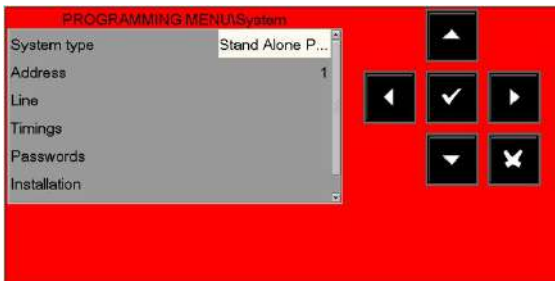

Refer to section:

- System type
- System address
- System line
- System timing
- System password
- System installation
- Relays

3.2.1 Programming – system - system type

This function allows the system network type to be selected as follows:

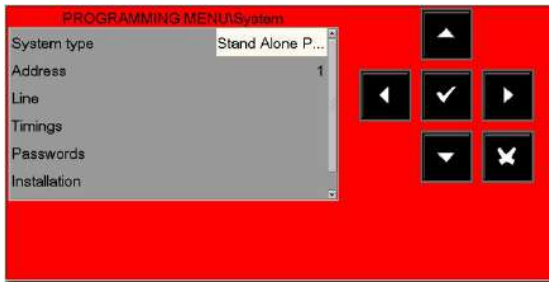

STANDALONE = single panel without network connection with up to 8 lines.

NET 128 = network of panels with up to 128 lines in total.

3.2.2 Programming – system - system address



The "Address" entry will assign the device number on the CAN-BUS network to the panel.

3.2.3 Programming – system – line

Style: OPEN LINE, CLOSED LOOP

This function allows the line connection type to be changed (in the memory).

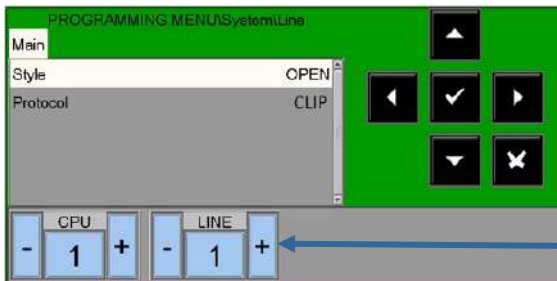

Press one of these keys to select the **previous** or **next** line.

Pressing the enter button first will activate the line editing function.

Use the arrow buttons to select the line style (OPEN - LOOP).

Press the enter button to confirm the programming.

LINE STYLE: open open line, closed closed line

Protocol: CLIP, APOLLO: configure the type of devices to use.

CLIP = Line managed with CLIP protocol (99 sensors + 99 modules).

3.2.4 Programming – system - timings

In this sub-menu you can configure delay times for the alarm outputs, the delay time for the sensor alarm check, silencing inhibition, etc.

ALARM-OUT TAB

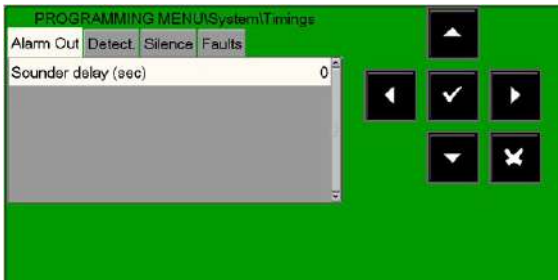

The "Sounder delay" timing is expressed in seconds, with values from 0 to max. 600 sec.

Press the ENTER button to activate the editing function.

Use the arrow buttons to enter the data; press enter to confirm the selected data.

Use the arrow buttons \uparrow \downarrow to select the item which needs to be changed ("Siren" or "Tx alarm").

Press the enter button \checkmark to activate the editing function.

Use the arrow buttons \uparrow \downarrow or the keyboard to enter the data; by pressing the enter button \checkmark you can confirm entered data.

The sounder activation delay can be programmed in seconds (max. 600 seconds).

The "Siren" and "TX alarms" activation delay timings are only active in the event of an alarm if the immediate activation of the outputs has been excluded in the exclusions menu.

DETECTORS TAB

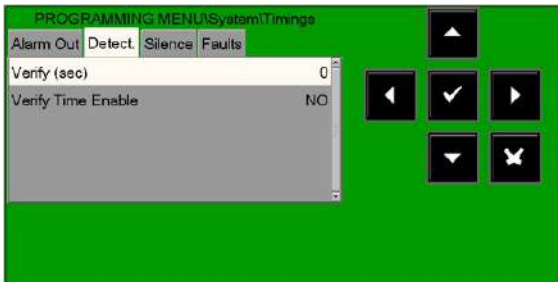

Press the right arrow button \rightarrow to change the verification time for the detectors:

The detector verification time allows the control unit to check for all installed sensors, for the time set, before confirming the possible alarm. The detector verification time can be programmed in seconds (max. 50 seconds).

N.B. This function will be effective only on the enabled sensors (refer to the Point programming menu)

Use the arrow buttons \uparrow \downarrow to select the item which needs to be changed ("Check" or "Check enabl. "). The editing function is activated by pressing the enter button \checkmark .

The arrow buttons \uparrow \downarrow are used to enter data and the enter button \checkmark is used to confirm entered data.

VERIFY ENABLE: if "YES" is selected, the verification function is ACTIVE with the programmed verification time (expressed in seconds).

SILENCE TAB

The **SELF-SILENCING TIME** is the time after which the output modules are reset, after being activated. Press the right arrow button ▶ to change the parameters to manage the **Silencing**.



The self-silencing function of each output module must be enabled in the Point programming menu.

The **silence inhibit time** is the time that output modules will remain active without the ability to be silenced by an operator.

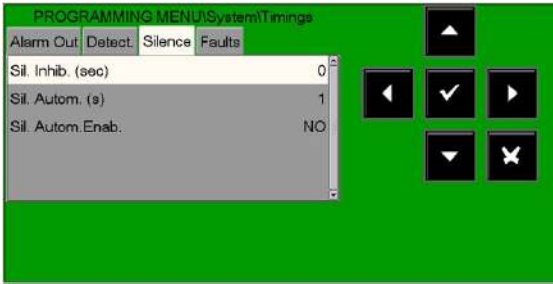

SIREN/HORN type ID outputs

Silence inhibition (sec):

Time after activation when silencing is not possible.

Silence autom. (s):

Minimum activation time.

Silence autom. enab.:

Enables the use of the activation time (with NO outputs are active until reset).

All timings are expressed in seconds, from a minimum of 0 seconds to a maximum of 255 seconds.

Pressing the enter button ✓ will activate the editing function.

The arrows ▲ ▼ are used to enter data and the enter button ✓ is used to confirm entered data.

FAULTS TAB

Press the right arrow button ▶ to change the parameters to manage the **fault signalling**:

MAINS FAULT DETECTION TIME is the minimum time during which mains fault is reported if there is no mains.

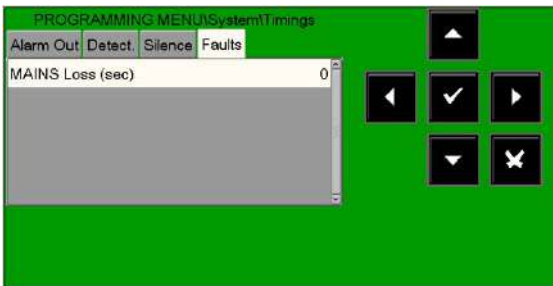

Mains loss

Timings are expressed in seconds, from a minimum of 0 seconds to a maximum of 300 seconds.

Use the arrow buttons ▲ ▼ to select the item which needs to be changed (“Mains”, “Tx faults”); pressing the enter button ✓ will activate the editing function.

The arrow buttons ▲ ▼ are used to enter data and the enter button ✓ is used to confirm entered data.

3.2.5 Programming - system - password

This function allows the password for the three access levels to be changed.

Each password consists of 5 numeric characters.

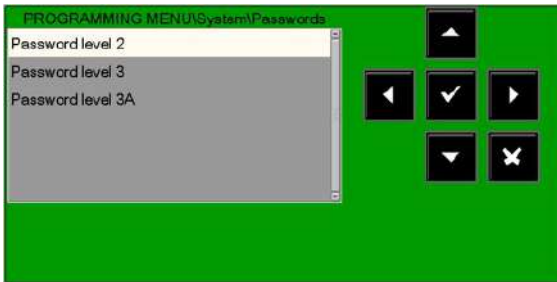

Use the arrow buttons ▲ ▼ to select the item which needs to be changed.

Press the enter button ✓ to activate the numeric keyboard in order to program the password.



Type the NEW password and press enter. Re-type and confirm the password entered.

3.2.6 System programming: installation

This function allows you to enter a programmable text for the panel. This text can have a **maximum of 32 characters** and is displayed on the screen when there are no alarms or faults (normal condition).

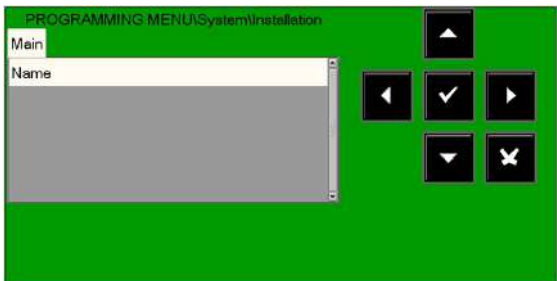

To enter the system name, press the enter button ✓ and use the alphanumeric keyboard to enter the text.

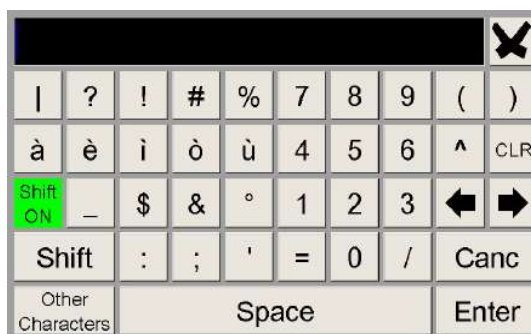
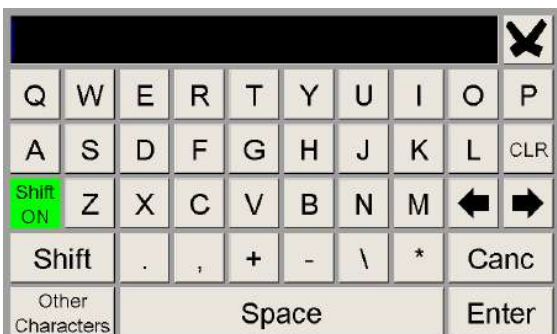

Once you have finished, press the **Enter** button to save the text.

3.2.7 Relay

This function allows you to define the functionality of the programmable user output available on the panel. Select the desired output then use the arrow buttons to select the item which needs to be changed. Press the enter button to confirm the selection.

3.3 Programming – points

In the Programming menu, selecting “Points” will display the following screen, where you can manually configure each type of addressable field device (detectors or modules).

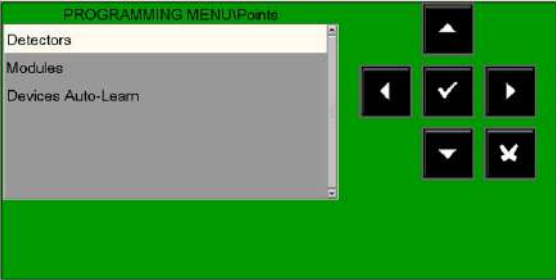

By selecting “DETECTORS” and confirming the selection with the enter button (✓), you can enter the programming procedure for addressable sensors.

This procedure is composed of four programming folders (to access the folders, use the arrow buttons ◀ ▶). The display shows the first device of the first line by default.

To select other devices, use the function buttons “- LINE” “+ LINE” (lines) and “- DET” “+ DET” (detectors).

3.3.1 Detectors MAIN TAB (SW type ID and text associated with the detector)



Press the "DET" number to open the following window, where you can enter the number of the sensor to be programmed directly without using the "+" and "-" keys.



Valid types for CLIP protocol detectors

SW TYPE ID	DEVICE TYPE
PHOT	Smoke optical detector
ION	Smoke ionization detector
THER	Thermal detector
PINN	“Laser” high sensitivity smoke detector
OMNI	“Omni sensor” detector

3.3.2 Detector PROGRAM TAB (programming of CBE equations, zone association)

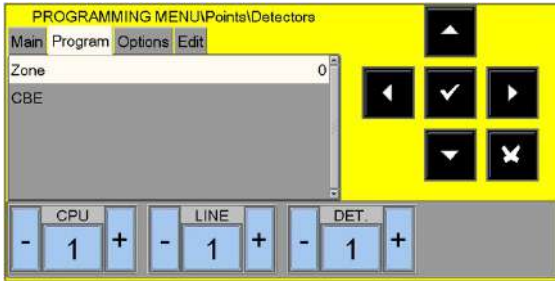

CBE for this point:

If a CBE is already programmed it is displayed here, otherwise the CBE text is displayed as shown.

Zone number

Associated with this detector.

Program zone associated with detector

Points are assigned to a zone in order to properly display the alarm location.

To assign the **zone** number in this folder to a device, select the device number using the arrow buttons $\uparrow \downarrow$, then press the enter button \checkmark . Use the arrow buttons $\uparrow \downarrow$ to change the zone number.

When you have finished, press the enter button \checkmark to confirm.

CBE = control by events

They are the programming instructions that set the actions associated with a point event.

See the relevant **CBE programming appendix** at the end of this manual for more detail.

To change the CBE field in this folder, select the parameter using the arrow buttons $\uparrow \downarrow$, then press the enter button \checkmark .



CBE for this point:

If a CBE is already programmed it is displayed here, otherwise the field is empty as shown.

3.3.3 Detector OPTION TAB

(programming of verification, sensitivity, day/night, tracking and LED flashing)

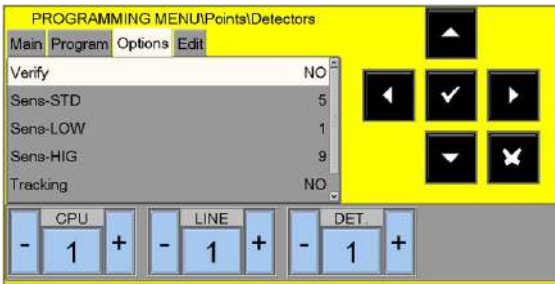

To change one or more parameters in this folder, select the desired parameter using the arrow buttons \uparrow \downarrow (the characters of the selected field are highlighted), press the enter button \checkmark and use the arrow buttons \uparrow \downarrow to change the parameter. When you have finished, press the enter button \checkmark to confirm the data.

Verify

When YES is programmed, the control unit can check the sensor for the time specified in the timing programming before confirming the possible alarm.

Sensor sensitivity programming

Default values:

- Standard sensitivity = 5
- Low sensitivity = 1
- High sensitivity = 9

Tracking

If the **tracking** option is enabled, when the device exceeds the alarm threshold the control unit activates the following indications.

- Output modules associated with CBE
- Buzzer
- Control unit siren output
- Alarm point indication on the display

When the point returns to the normal status, the **output modules associated with CBE return to normal mode**, while the following signals are still active:

- Buzzer
- Control unit siren output
- Alarm point indication on the display

To clear all signals, perform the reset procedure.

LED flashing

Selecting NO for this option will disable the LED flashing for the sensor during polling. This function can be used in some environments such as hospitals, hotels, etc.

3.3.4 Detector EDIT TAB

(for all sensors which allow points to be removed and copied from...to...)

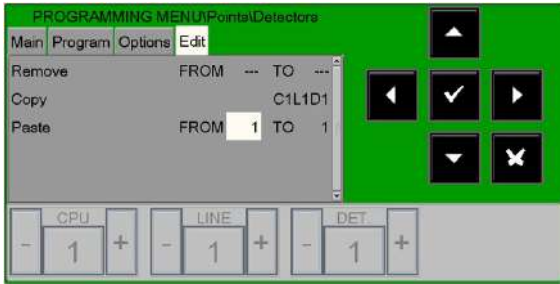

This TAB allows for the programming of batches of points that share the same configuration.

It can be used if the points have consecutive addresses and have common parameters.

The “**Remove from ...to**” function allows an entire consecutive batch of points to be eliminated from the configured control unit by entering the start and end addresses.

The copy and paste functions allow a batch of points to be programmed and can be used if devices in the same line have consecutive addresses and common parameters.

The procedure for the block programming is as follows:

- Select a device from which the parameters need to be copied (HW type ID, CBE, etc.).
- Use the “Copy” function to save all the parameters of the previously selected device (except for the zone number assigned “000”) in a memory support area.
- When this function has been performed, the display reports the result:

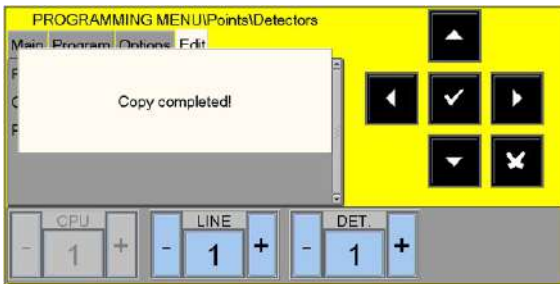

Use the “**Paste From ...to**” function for the programming of block points as indicated:

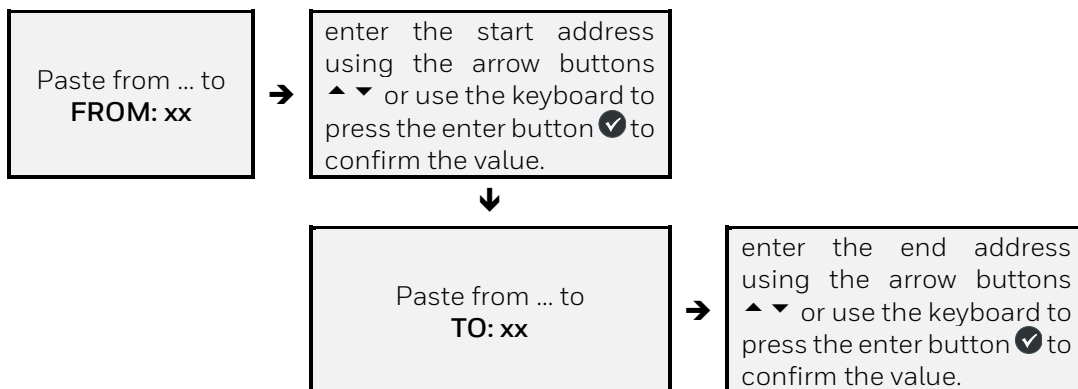

4 Example of programming a CLIP sensor with SW TYPE ID “OMNI” MI-PTSE-S2, MI-PTIR-S2

4.1.1 Main TAB (programming type ID and text associated with the sensor)

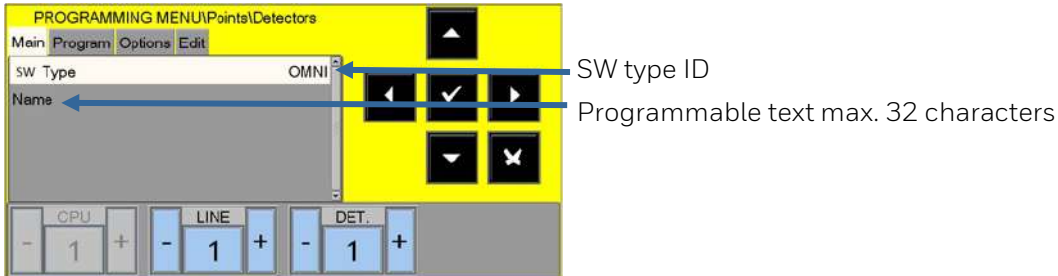

4.1.2 Program TAB (programming of CBE equation, zone association)

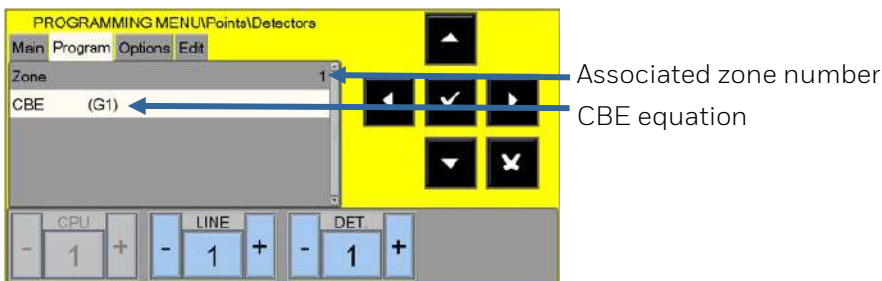

4.1.3 Option TAB (programming of check, at level, day/night, tracking and LED flashing)

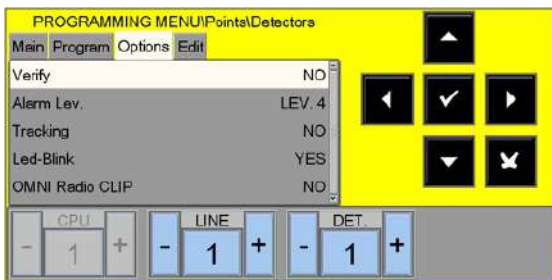

ALARM LEVEL	Corresponding percentage of obscuration inside the sensor chamber
ALARM 1	1 % ft
ALARM 2 - COMP.AUT.	1 % - 2 % ft
ALARM 3	2 % ft
ALARM 4 - COMP.AUT.	2 % - 3.5 % ft (default)
ALARM 5	3.5% ft

N.B.: The "heat only" mode is activated automatically if the "day/night" function has been programmed for the zone associated with the MI-PTSE-S2 sensor.

4.2 Example of programming a CLIP sensor with SW TYPE ID “PINN” MI-LZR-S3I

4.2.1 Main TAB (programming of type ID and text associated with the sensor)

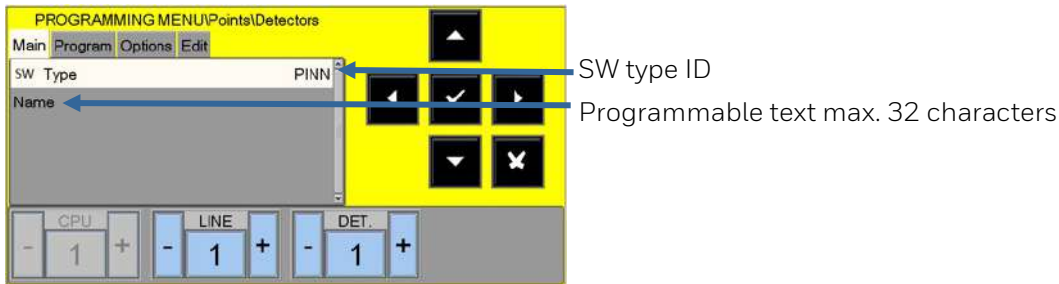

4.2.2 Program TAB (programming of CBE equation, zone association)

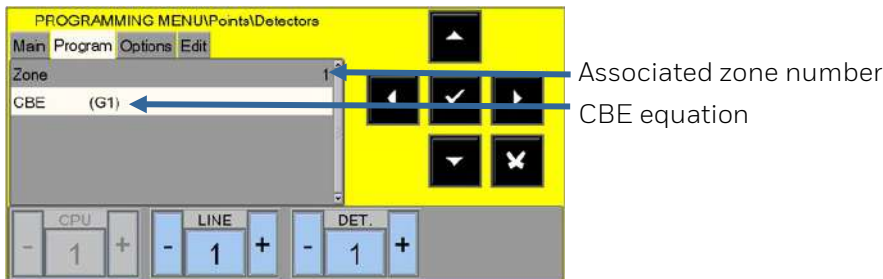

4.2.3 Option TAB (programming of check, al. level, day/night, tracking and LED flashing)

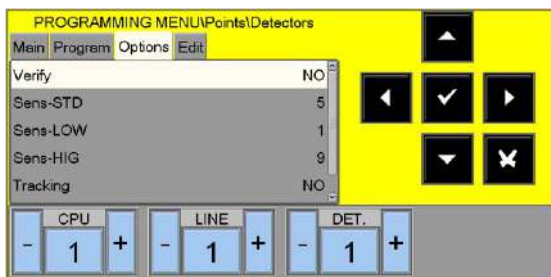

Sensitivity

Value	Corresponding percentage of obscuration inside the sensor chamber
1	2 % ft (default for Sens-LOW)
2	1.5 % ft
3	1 % ft
4	0.5 % ft
5	0.2 % ft (default for Sens-STD)
6	0.1 % ft
7	0.05 % ft
8	0.03 % ft
9	0.02 % ft (default for Sens-HIGH)

5 MODULES

By selecting the **Modules** menu and confirming the selection using the enter button (✓), you can access the programming procedure. This procedure is made up of four programming folders (to access the folders use the arrow buttons ◀ ▶).

The display shows the first device of the first line by default. Use the arrow buttons to select another device.

5.1 INPUT MODULES

5.1.1 TAB programming of SW type ID and reading associated with the module

The display shows the first device of the first line by default. Use the function buttons to select another device.

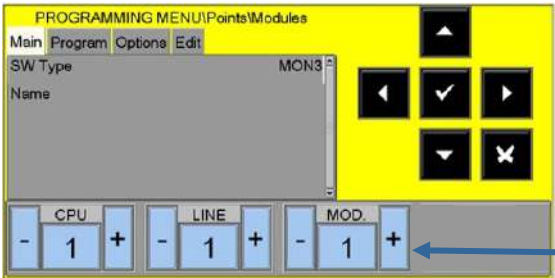

SW type ID: (refer to the SW type ID table)

Q	W	E	R	T	Y	U	I	O	P
A	S	D	F	G	H	J	K	L	CLR
Ctrl	Z	X	C	V	B	N	M	←	→
Shift	.	,	+	-	\	*			Cancel
Other Characters	Space							Enter	

Press key “-” and “+” for MOD to select the next or previous module.

5.1.2 Programming TAB (programming of CBE equation, zone association)

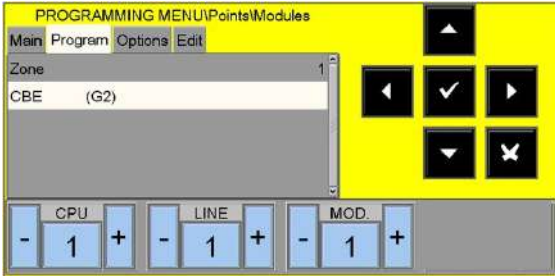

For a description of “**How to**” operate and the description of **CBE** and **zone** field, please refer to the sensor programming screen previously detailed.

5.1.3 Option TAB (programming tracking and LED flashing)

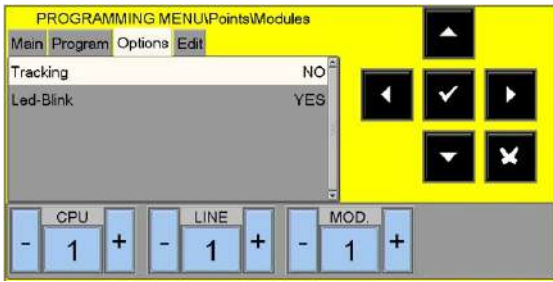

For a description of “**How to**” operate and a description of the **tracking** and **LED flashing** field, please refer to the sensor programming screen previously detailed.

5.1.4 Edit TAB

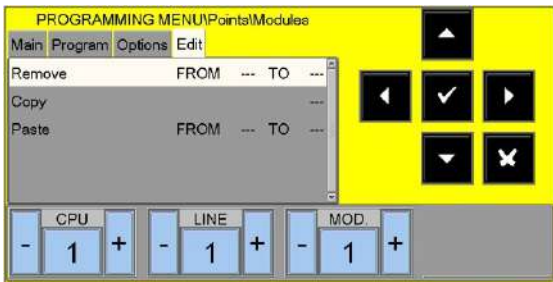

For a description of “**How to**” operate and a description of the **edit options**, please refer to the sensor programming screen previously detailed.



For the instructions on “how to” operate, refer to the “POINT programming procedure” as this part is the same for modules.

5.2 OUTPUT MODULES

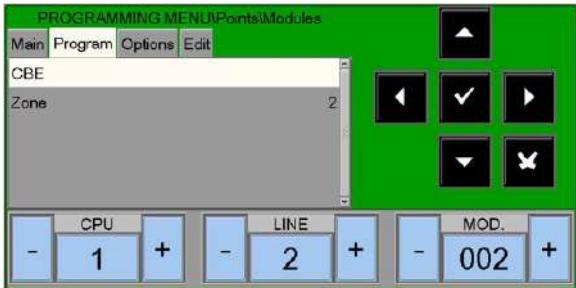
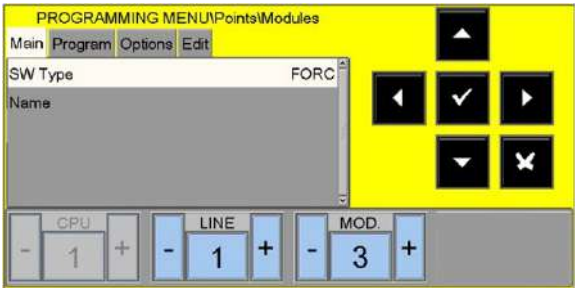

The main and program TAB are the same as for input modules. Please refer to the previous pages.

5.2.1 TAB or option (programming disabled silencing, test enabling and LED flashing)

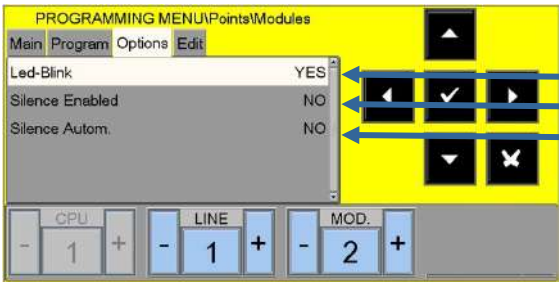

- LED on device enabled to flash
- Enable manual silencing
- Enable self-silencing

6 Auto-learn - automatic detection of installed devices

From the Points menu, by selecting “**Auto-Learn**” and confirming the selection using the enter button , you can access the self-programming procedure for the devices installed on the loop.

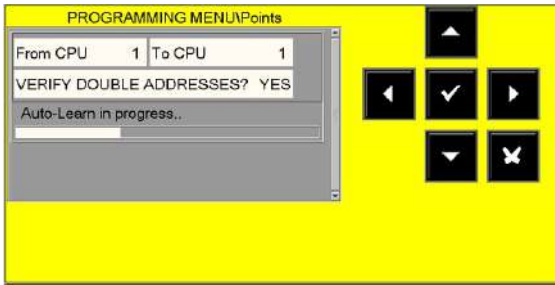

Verify double address: YES

When YES is selected, the panel will check for more than one device programmed with same address on a line.

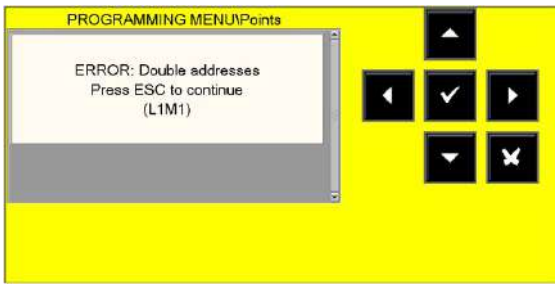

If several devices programmed with the same address are found, the message shown in the figure is displayed with an indication of the duplicated address. The user will be able to identify the devices with the same address because the LEDs of the relevant devices are activated.

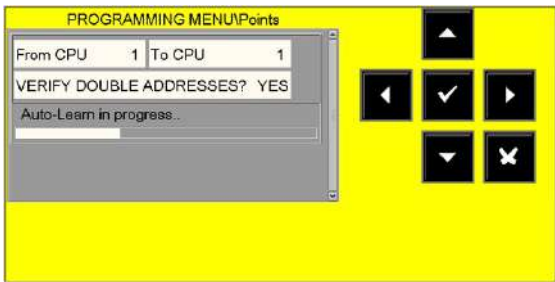

Once double addresses have been removed, you can restart the Auto-Learn process again.

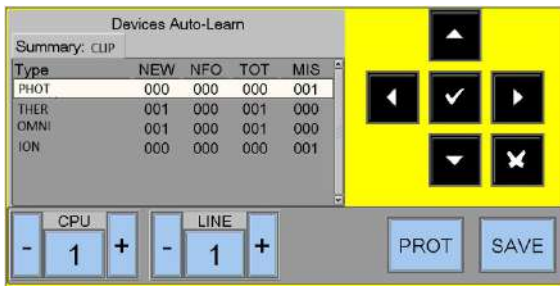

At the end of the auto-programming procedure a summary of the devices found on the line is displayed.

Where:

TYPE = type of devices found (see table above)

NEW = new devices found

NFO = devices previously programmed but not consistent with what was detected during the auto-learn procedure

TOT = total devices detected on the line (NEW + NFO + correctly programmed devices.)

MIS = devices previously programmed but not detected during the auto-learn

The **SAVE** button saves the devices detected during the auto-learn according to the following mode:

- **NEW and NFO are** initialised using the default data
- **MIS** are removed
- The correctly programmed devices keep the current programming.

The data relevant for the initialised devices can then be changed by entering the point programming procedure.

The **PROT** (protocol) menu can display the table of devices for one of the two possible protocols: CLIP or APOLLO

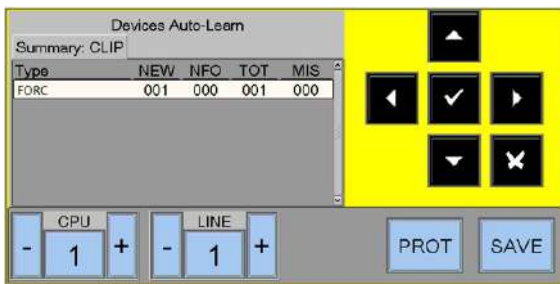

Sample screen for CLIP module

7 Summary of SW type ID for modules



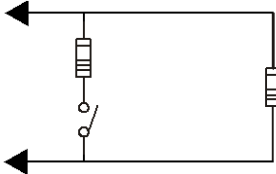
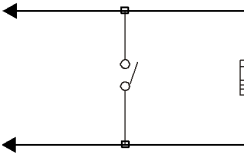
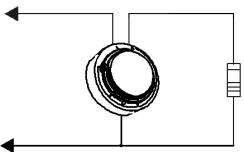
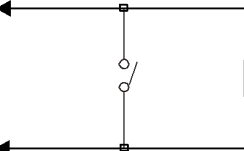
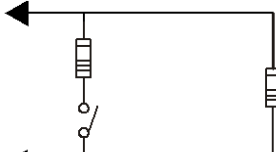
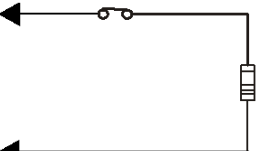

7.1 INPUT MODULES

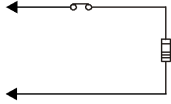
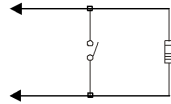
CONNECTION TYPE	SW TYPE ID	TYPE OF DEVICE
	MON3	Input module Input module used for N.O. contacts (Connection complies with EN 54).
	MON	Input module used for N.O. contacts or any device Not compliant with EN 54.
	SCON	MMX-2 input module (obsolete module) Input module used for four-wire conventional smoke detectors not detected during the self-programming. N.B.: this type has a reset time which is longer than the modules programmed as "MONITOR".
	SCO2	It is valid for the MI-DCZM and MI-DCZRM module for the connection of conventional sensors. It is automatically detected during the self-programming.
	NONA	Input module Input module used to interface with N.O. contact, with alarm when it is closed. The activation of a "NONA" type module does not generate an alarm condition, i.e.: <ul style="list-style-type: none"> the alarm LED is not on "APND" or "GPND" type modules do not activate. Only output modules coupled to CBE are activated.
	STAT	Input module used like the NONA device, but each state change is activated by the buzzer for one second.
	PULL	Same as MON3; in addition, the "MANUAL BUTTON" reading appears.
	NCMN	Input module used to check the N.C. inputs. When the line is off, an alarm is indicated. If there is a line short circuit, a FAULT is indicated.

7.1.1 INPUT MODULES FOR GENERAL SERVICES

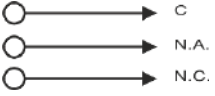
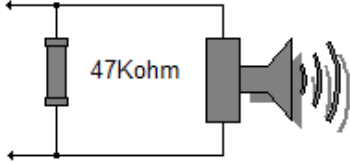
CONNECTION TYPE	SW TYPE ID	TYPE OF DEVICE
	MTRB	Input module used as a tamper signal. It signals a breakdown via an alarm input.
	MACK	Input module used to perform remote ACK (pulse).
	MTAC	Input module used to perform remote SILENCING (pulse).
	MRES	Input module used to perform remote RESET (pulse).

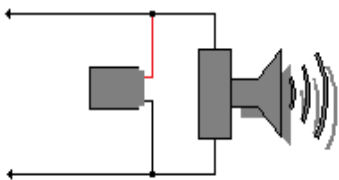
7.2 OUTPUT MODULES

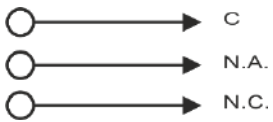
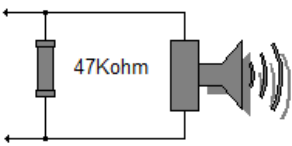

CONNECTION TYPE	SW TYPE ID	TYPE OF DEVICE
	FORC	Relay output module with potential free contacts.
	CON	Output module with supervision of the line of command devices.  AGILE gateway MI-GATE must be configured as an output with SW type CON.
	CONV	Output module with supervision of the line of controlled devices (VdS standard compliant).
	GSND	Software type dedicated to the following HW types (sirens addressed): WMSS, WMS, WMS, DBSS, DBS.
	GSTR	Software type dedicated to the following HW types (directional flashes): WMSS, WMSB, DBSS.

7.2.1 OUTPUT MODULES FOR GENERAL SERVICES

CONNECTION MODE	SW TYPE ID	DESCRIPTION
	PWRC	FORC output module used to temporarily interrupt power supply, during SYSTEM RESET, for the four-wire conventional smoke sensors, powered by a remote power supply. N.B.: this type WILL NOT be programmed for SILENCING
	GPND	FORC output module activated on each alarm or fault. It is reset via ACK.
	APND	FORC output module activated on each alarm. It is reset via ACK.
	GAC	FORC output module activated on each alarm. It is reset via RESET.
	TPND	FORC output module activated on each fault. It is reset via ACK or via the fault RESET.
	GTC	FORC output module activated on each fault. It is reset via RESET.
	TRS	FORC output module activated on each FAULT. It is only reset via the fault RESET.
	ZFLT	FORC output module activated on each FAULT in the zone with which it is associated. It is only reset by removing the fault from the zone.
	ZDIS	Output module activated in the event of exclusion of a point or a zone.
	MAINF	Output module (non-supervised output) activated when a MAINS fault is present.
	REM	FORC output module activated from a remote command (supervisory SW).
		GAS
GTS		CON output module activated on each fault. It is reset via RESET.
ZFLTC		Output module activated in the event of a fault in the zone with which it is associated.
MAINFC		Same as MAINF, but supervised output.
REMC		CON output module activated from a remote command (supervisory SW).

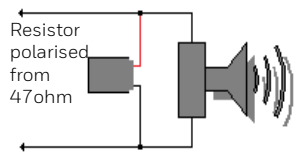

The output modules used for the abovementioned functions do not accept CBE.

CONNECTION MODE	SW TYPE ID	DESCRIPTION
	GASV	CON output module activated on each alarm. It is reset via RESET. (Complies with VdS 2489).
	GTSV	CON output module activated on each fault. It is reset via RESET. (Complies with VdS 2489).
	ZFLTV	Output module activated in the event of a fault in the zone with which it is associated (complies with VdS 2489).
	MAINFV	CON output module activated in the event of a power supply fault (complies with VdS 2489).
	REMV	CON output module activated from a remote command (supervisory SW - complies with VdS 2489).
	SND	Software type ID only for the following models: WMSS, WMS, WMS, DBSS, DBS activated on each alarm, follow the sounder output status.
	STR	Software type ID only for the following models: WMSS, WMSB, DBSS activated on each alarm, follow the sounder output status.

8 GROUPS programming menu

A group is a set of software devices that can perform associations. When a sensor or a module (which belongs to the group) is in alarm status, the group activates. If an output module is part of the same group, it will be activated.

This procedure is composed of three programming folders, in which the editing function previously described in the paragraph “Description of using the keyboard to enter data in the programming folders” is used to enter data.

Groups can be programmed as the following **types**:

Direct activation group. It activates what is contained in its CBE equation.

It is activated by direct inputs/groups (which have the group in their CBE equation).

Reverse activation group. It is activated by its CBE equation.

It activates reverse output/groups (which have the group in their CBE equation).



One reverse group can be the “sum” of several direct groups. This means that activation can be triggered by many groups.

8.1 Main TAB

(programming the maximum limit of the direct-action group number)

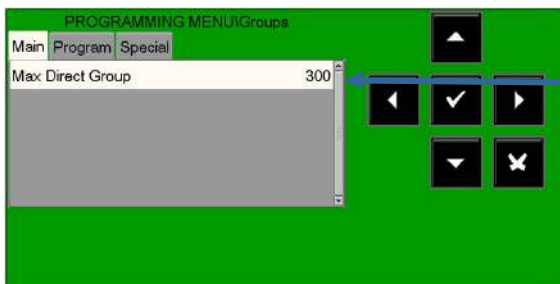

Enter the maximum number of direct activation groups

8.2 Program TAB (programming type, CBE and cross alarm)

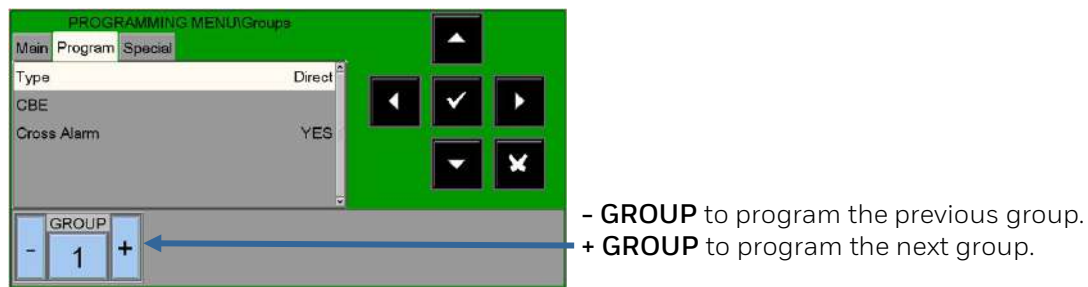

8.2.1 CBE equation

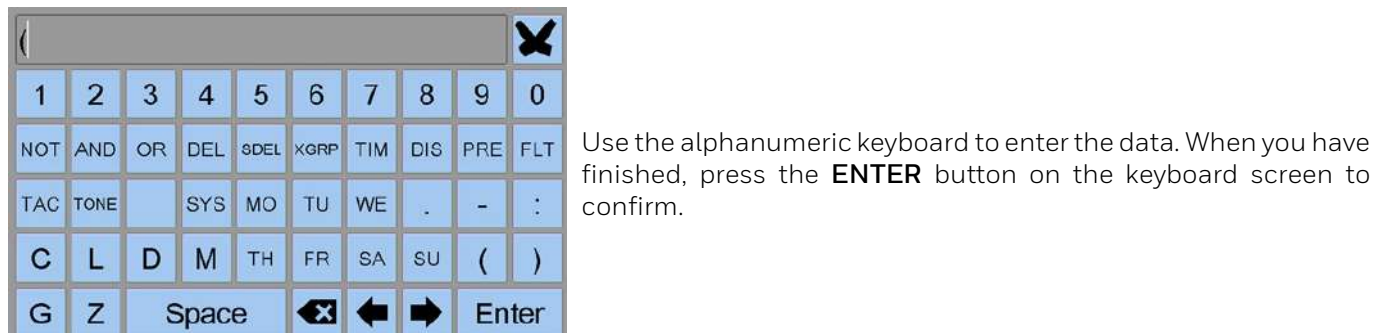

CROSS ALARM

The **cross alarm** parameter is only valid if the group is associated with the “XGRP” operator in a CBE.

- NO** : the group is only active if a thermal sensor (a detector with SW TYPE ID “THER”) **and** an optical sensor (a detector with SW TYPE ID “PHOT”) associated with the group are in alarm status.
- YES** : the group is active if two devices (sensors or input modules) associated with the group are in alarm status. **This is the default value.**

Example of typical use for reverse groups:

You have to program an OR of 16 groups

BUT

There is not enough memory!

SO

Program two reverse groups, each with a CBE that lists eight direct groups.

Then, on the output module, program a CBE that is the sum of the two reverse groups.

```
G301 = reverse group
G302 = reverse group

G301=OR (G1 G2 G3 G4 G5 G6 G7 G8)
G302=OR (G9 G10 G11 G12 G13 G14 G15 G16)

L01M01→CBE=OR (G301 G302)
```

8.3 HIGH AND LOW SENSITIVITY GROUPS

Can be defined as two groups, **to be chosen from the inverse ones available**, for which a CBE equation must be programmed by using the **TIM** operator so that they are only active during a set time.

These groups are defined respectively as: high sensitivity groups and low sensitivity groups.

The purpose of this option is to make all installed sensors operate in the control unit at high or low sensitivity when the relevant groups are active (this will result in the DAY/NIGHT function).



The “thermal only” operating mode for detectors with SW TYPE ID OMNI is active automatically if the group defined as “low sensitivity” is active.

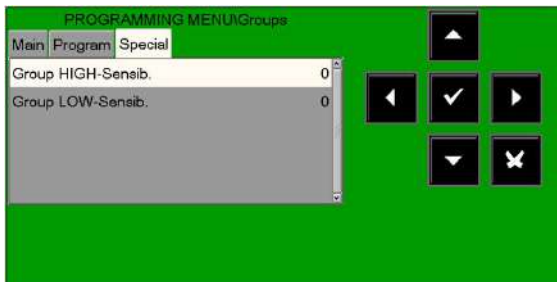

Example:

G301 = TIM (-- 18.00 08.30) CBE of the high sensitivity group

G302 = TIM (-- 08.30 18.00) CBE of the low sensitivity group

For the zones which have been assigned this function, the parameter **“day/night = YES” (refer to zone programming)** must be programmed. This means that the system automatically associates the high and low sensitivity groups, meaning that the following two-time schedules are obtained:

Day schedule (low sensitivity) from 8:30 am to 6:00 pm (the sensitivity values assumed by the detector are those programmed in the **“Sens-Low”** item in the option folder).

Night schedule (high sensitivity) from 6:00 pm to 8:30 am (the sensitivity values assumed by the detector are those programmed in the **“Sens-High”** item in the option folder).

9 ZONE programming menu

By selecting the “Zones” sub-menu, you can enter a descriptive text to be associated with the selected zone. The control unit is located in the first zone by default.

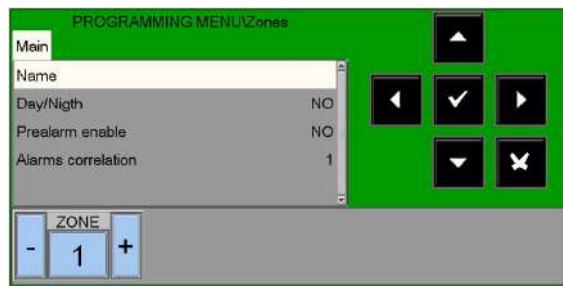

Name:

Programmable text for the ZONE max. 32 characters. To enter the text, press the enter button to enable the editing function.

Use the alphanumeric keyboard to edit the zone name and press the enter button to save the value.



Day/night: YES/NO

When “YES” is set, this zone will use the programmed HIGH-LOW sensitivity groups (refer to **HIGH AND LOW SENSITIVITY GROUPS** above) to switch to LOW sensitivity during the day and to HIGH sensitivity during the night.

Pre-alarm enable: YES/NO

This feature allows you to view and manage the pre-alarm for sensors assigned to the zone.

Alarm correlation

Indicates the number of alarm devices assigned to the zone to activate the siren outputs associated with this zone.

Example:

IF	Zone 1 alarm correlation = 3
AND	in the "Utilities/Parameters/Specials/Sirens" menu you have programmed the entry "Active sirens on correlation" = YES
THEN	at least three devices in zone 1 need to be in alarm condition in order to activate the siren output and all programmed SND type modules associated with this zone.

9.1 Programming - CONFIGURATION menu

This function allows for the configuration of the panel units connected to the CAN bus network.

9.1.1 CPU tab (programming CPU and loops)

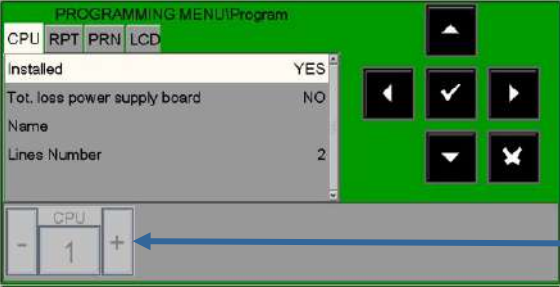

To modify the configuration, press the enter button ; use the arrow buttons to change the parameter; when you have finished, press the enter button to confirm.

Press key - CPU or + CPU to program the **previous/next MA-X000**.

9.1.2 RPT tab (programming for CAN bus repeater)

Programming the presence on the CAN BUS network of the **MA-BST-C** card (amplifier for CAN BUS line).



Up to eight **MA-BST-C** cards can be installed on the CAN BUS network.

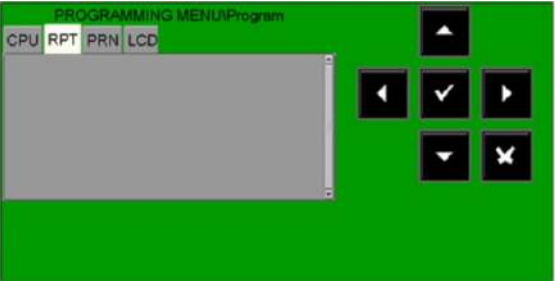

To modify the configuration, press the enter button ; use the arrow buttons to change the parameter; when you have finished, press the enter button to confirm.

9.1.3 PRN tab (programming printer interface)

This function allows you to configure the presence of the interface for connecting a serial printer to the RS232 port.

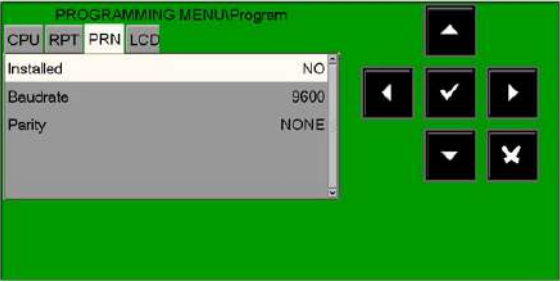

To modify the configuration, press the enter button ; use the arrow buttons to change the parameter; when you have finished, press the enter button to confirm.

9.1.4 LCD tab (programming of repeaters)

This function allows you to set the MA-LCD7 model in the control unit.

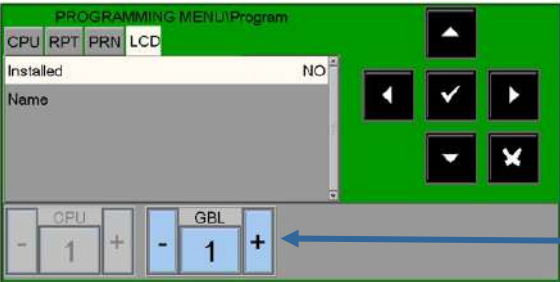



This feature allows you to enter a programmable text of max. 32 characters, which is displayed on the LCD repeaters.

Press key - LCD or + LCD to program the **previous/next LCD** terminal.

9.2 Programming – delete configuration

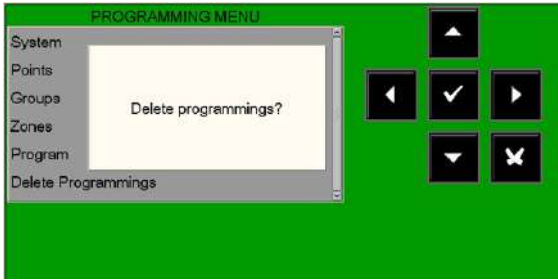
This function will restore everything to default programming (**NO NETWORK**):



Press the enter button  to remove system data in the non-volatile memory of the panel. Panel memory will be formatted.

10 UTILITY MENU

Selecting UTIL from the main system screen will take you to the Utility menu, which includes some functions generally used by servicing personnel.

To access the menu, enter the level 3 password (**33333** is the default password). To enter the password, refer to the editing function previously mentioned in the description of the keyboard operation.

The following menu is displayed:

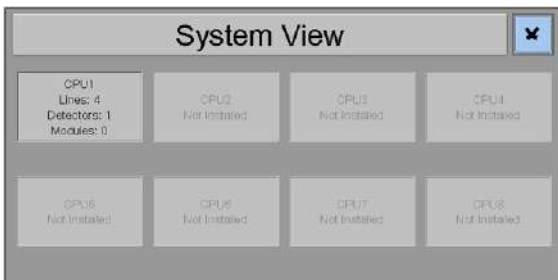

UTILITY – System View: displays the system CPU configuration.

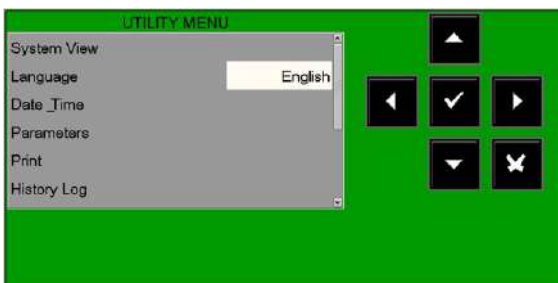

UTILITY - Language: it is possible to select different system languages from the available options.

UTILITY - Date & time: this function allows you to set the time and date of the control unit.



Date



Hour

To change values in “Date & time” tabs, use the arrows ◀ ▶ to select the field to be changed (the characters of the selected field are white on a dark background). Use the arrow buttons ▲ ▼ to change the value. When you have finished, press the enter button ✓ to save the value.

10.1 Parameters

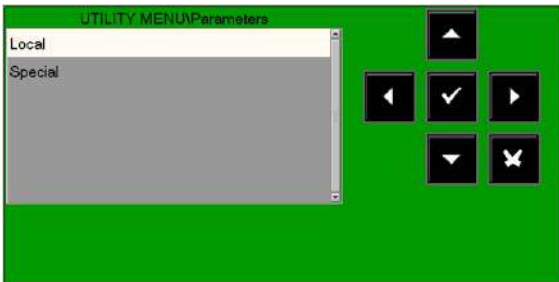

By selecting the “Parameters” option, you can configure the local and special parameters as shown in the following figures:

10.1.1 Local parameters



If “NO” is selected for the “LED blink” function, then the LED flashing is disabled for **all the points** recognised during the line interrogation. This function can be used in some environments such as hospitals, hotels, etc.



The LED flashing can also be disabled for each point (refer to the sensor and module programming paragraphs).





To enable/disable the “LED blink“ function, press the enter button ✓ then use the arrow buttons ▲ ▼ to change the value; when you have finished, press the enter button ✓ to confirm.

10.1.2 Special parameters

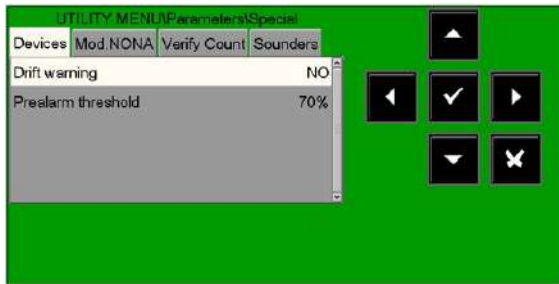
This menu has five programming folders:

1. Programming the DRIFT WARNING FUNCTION



To change the “**Drift warning**” function, press the enter button ; use the arrow buttons   to change the parameter; when you have finished, press the enter button  to confirm.

DRIFT WARNING - when this function is enabled, the control unit generates a signal when the sensors exceed 70% of the alarm threshold for more than five minutes.

This indication can be used as a warning that the optical chamber for smoke detectors needs to be cleaned. This function is a general enable parameter valid for all the control unit points. The drift warning function does not replace the maintenance request, which is always enabled in any case. It is activated when a sensor detects a value higher than 80% of the alarm threshold for more than 36 consecutive hours.



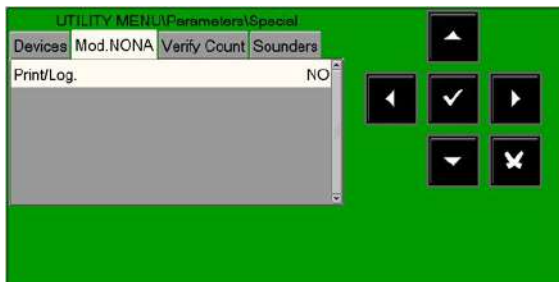

Detector pre alarm threshold

Programmable in the range 30% ÷ 99%. The default is 70%.

2. Mod. NONA: enable display & log in history file for events of modules with SW TYPE ID NONA



Selecting “NO” will disable the printing and saving in the history file of events in alarm status from input modules programmed with SW TYPE ID **NONA**.

To change the option, press the enter button  and use the arrow buttons   to change the parameter; when you have finished, press the enter button  to confirm.

3. Verify count: change the line reliability parameters

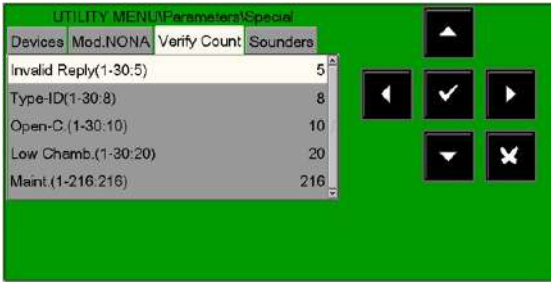

Invalid Reply: enter the parameter to report the fault for invalid reply (expressed in number of interrogation polling on the line). Default value = 05.

Type-ID: enter the parameter to signal type ID invalid fault (expressed in number of interrogation polling on the line). Default value = 08.

Open-C: enter the parameter to signal open circuits fault (expressed in number of interrogation polling on the line). Default value= 10.

Low Chamb.: enter the value to signal a fault for smoke detector low chamber value (expressed in number of interrogation polling on the line). Default value= 20

Maint.: enter the parameter to signal the maintenance shutdown. (expressed in minutes). Default value = 216.

To change one or more parameters in this folder, select the parameter using the arrow buttons ▲ ▼ (the characters of the selected field are highlighted), press the enter button ✓ and use the arrow buttons ▲ ▼ to change the parameter. When you have finished, press the enter button ✓ to confirm the values.

Increasing the values of each parameter will make the control unit less sensitive for the fault signalling for the points installed on the lines.

Decreasing the values of each parameter will make the control unit more sensitive for the fault signalling for the points installed on the lines, and the fault warning message will be activated: **“Line changed par.”**

4. Sounder: this tab is dedicated to programming the siren outputs (all devices programmed with SW TYPE ID SND). The user can program the following items:

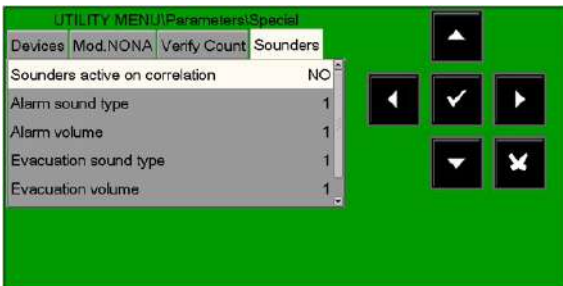

Sounders active on correlation: if this function is enabled, when there is an alarm siren associated with this zone will be activated only if the programmed correlation number for the alarm zone is reached (see ZONE programming paragraph).

Alarm sound type: sound tones in the event of an alarm from addressed devices (values from 1 to 32 permitted. For details, refer to the technical data sheets for the sirens).

Alarm volume: in the event of an alarm from addressed devices (values from 1 to 4 permitted. For more details, refer to the technical data sheets for the sirens).

Evacuation sound type: sound tone when activating the central evacuation control (values from 1 to 32 permitted. For more details, refer to the technical data sheets for the sirens).

Evacuation volume: values from 1 to 4 permitted. For more details, refer to the technical data sheets for the sirens).

Print tab: to access the list of options dedicated to printing events.



Prints the contents of the **history log**.

Prints the **analogue values of the programmed sensors** in the control panel.

Prints the list of **alarm points** in progress.

Prints the list of **pre-alarm points** in progress.

Prints the list of **zone in faults** in progress.

Prints the list of **excluded points**.

Prints the list of **active input modules**.

Prints the list of **active output modules**.

11 UTILITY - history log

The history log has a capacity of 10.000 events. Once the maximum number of events in the memory has been reached, when a new event occurs the panel clears the oldest event from the event log and saves the new one.

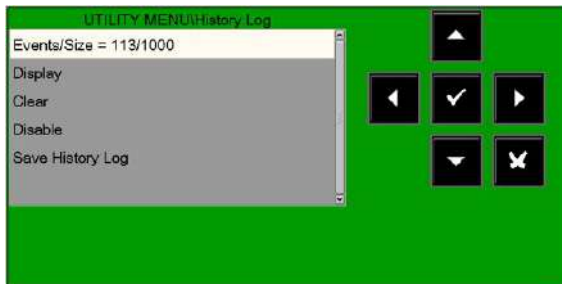

Events/Size: displays actual memory use in the history log.

Display: this function allows the events in the history file to be visualised.

Clear: the clear function will delete all events in the history file.

Disable: this function disables the saving of all the events (alarms, faults, etc.). Saving is enabled **by default**.

Save History Log: this function will save the history log file on a memory stick in the USB port.

History log display: this function allows the events in the history file to be visualised on the panel display.



Enter the start date and time for the search and press the enter button to confirm.

Select YES/NO to filter the type of events to be displayed.

To change one or more parameters in this folder, select the parameter using the arrow buttons (the characters of the selected field are highlighted), press the enter button and use the arrow buttons to change the parameter. When you have finished, press the enter button to confirm the values.



Selecting **Display** will display the first two events.

Use the arrows buttons to scroll through the list of all events.





This display appears when the **“Clear”** function is selected:

Press the enter button to delete all events stored in the history log.

Disable history log: if the “**disable**” function is activated, no new events arriving from either the detection lines or the repeaters will be saved in the history log.

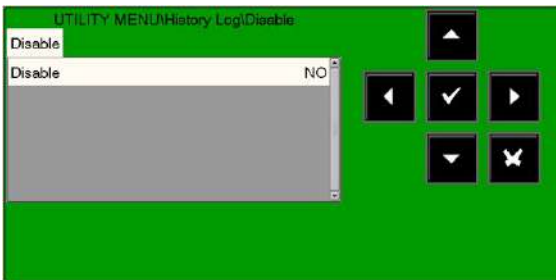
If the history log is disabled, a system fault is reported in the faults list.



To change this parameter in this folder, press the enter button  and use the arrow buttons   to select **YES** or **NO**.



The **disable** function is set to **NO** by default.

Save history log: this function will save the history log file on a USB memory stick.

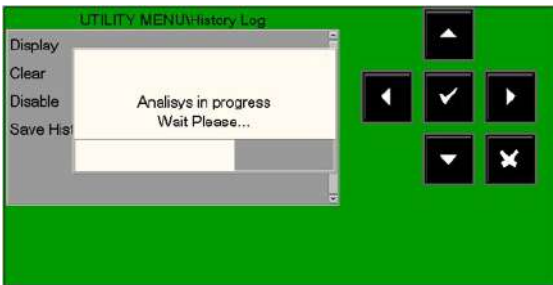

12 UTILITY - VIEW/MODIFY STATUS

This function allows you to examine the status of a point and, in the case of a detector, the analogue value can also be displayed. This value will be displayed as a percentage with respect to the alarm threshold programmed for that device.

Parameters relevant to modules, zones or software groups that have been programmed can also be displayed.

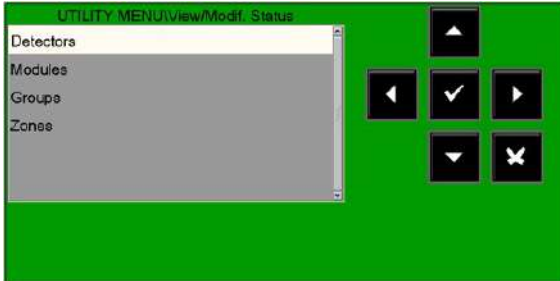

Detector status

The display shows the first device of the first line by default. To select another device, use the function buttons.

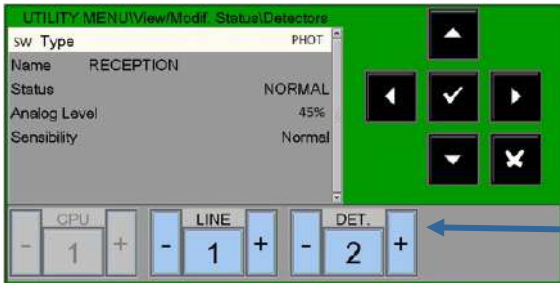

Module status depends on module type (input or output).

Use - LINE or + LINE to display previous/next Line
Use - DET. or +DET.
to display previous/next detector.

Module Status

The display shows by default the first device of the first line. To select another device, use the function buttons.

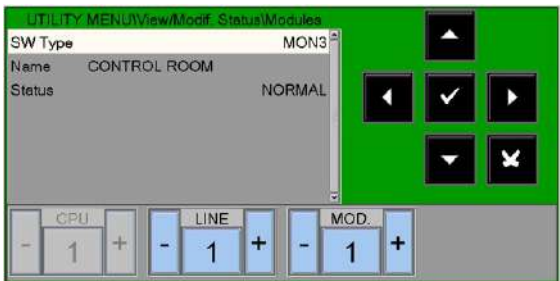

Module status depends on module type (Input or Output)

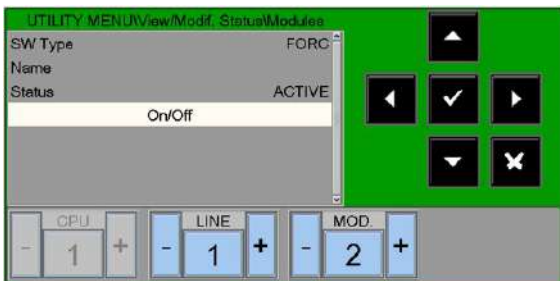

Modify the output status of a control module

After selecting the "On/Off" field using the arrow buttons \uparrow \downarrow , the user can switch the control module output by pressing the **OK** \checkmark button.

This action is indicated as:

Activated = ON

Deactivated = OFF

Groups status

The display shows the first group by default. To select another group, use the function buttons.

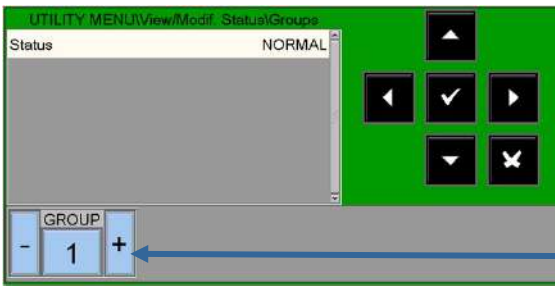

Use - **GROUP** or + **GROUP** to display the previous/next group.

Zones status

The display shows the first zone by default. To select another zone, use the function buttons.

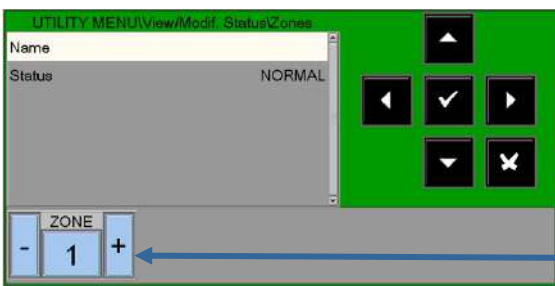

Use - **Zone** or + **Zone** to display the previous/next zone.

12.1 UTILITY – ACTIVE MODULE LIST

You can use this function to examine the lists of active modules that are connected to the control unit lines.

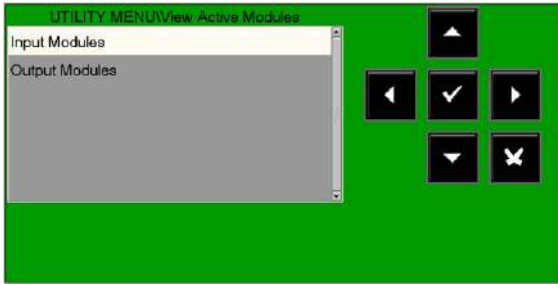

Input modules

Active input modules are displayed as follows:

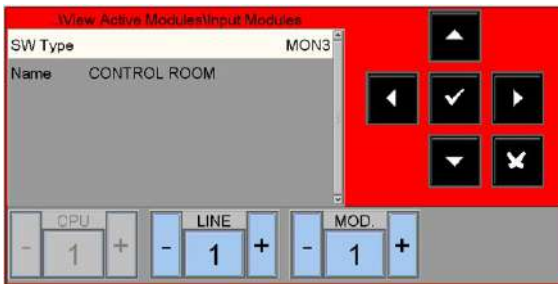

The following comment is provided for a line where there are no alarm input modules:
"No active input module"

Output modules

Active output modules are displayed as follows:

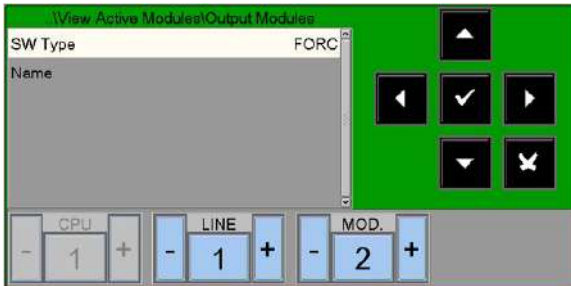

The following comment is provided when there are no active output modules in a line as shown in the figure below:
"No output module active"

12.2 UTILITY - FIRMWARE version

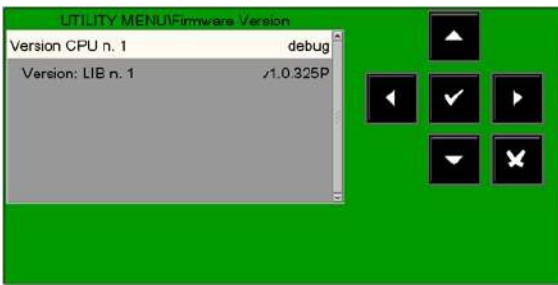

The servicing personnel can use this function to display the firmware version installed in the MAx control unit CPU, LIB card and LCD display.

12.3 Firmware update

This function will upload a new version of the firmware from a USB memory stick inserted into the dedicated port.



This operation must be authorised by Honeywell Technical Service.

13 DISABLE MENU

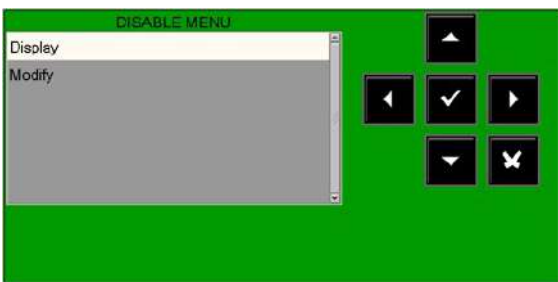

By pressing the **DISABL** function button in the main system status screen, you can access the disable menu, where detectors, modules, zones, etc. can be disabled.

This menu is displayed.

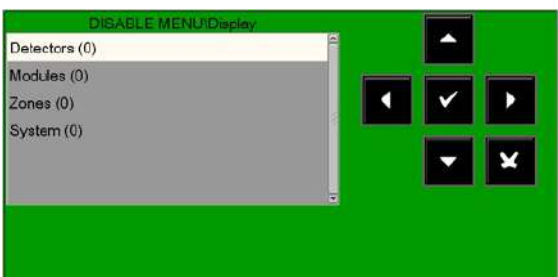

By selecting the display option, the user can access the following menu where devices are displayed according to type: Counters for the number of disabled devices according to type.

To display the disabled device list, use the arrow buttons **▲ ▼** to select the type of device, and press the enter button **✓** to confirm the selection.

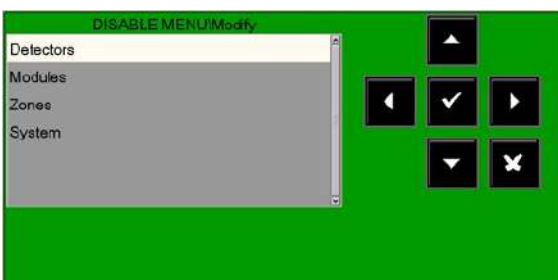



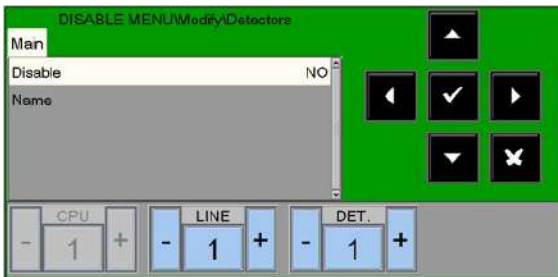

Selecting the **modify** option, and **entering the correct level 2 password**, will bring up the following display, where it is possible to change the enabled/disabled status for the various devices:

Modify status - detectors

The display shows the first device of the first line by default. To select another device, use the function buttons.



When a detector is **disabled**, the control unit is prevented from receiving alarms and fault signalling from the sensor.



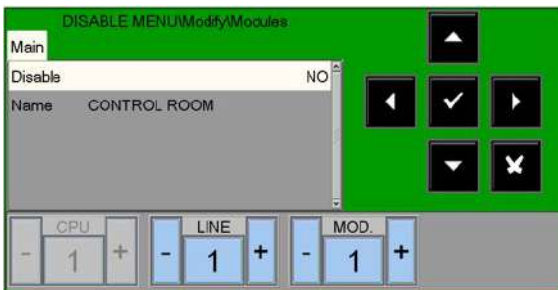

To **disable** a detector, select it using the function buttons. Once the device has been selected, press the enter button , use the arrow buttons   to select **YES** and then press the enter button  to confirm the disablement.

Modify status - modules

The display shows the first device of the first line by default. To select another device, use the function buttons.



When a module is **disabled**, the control unit is prevented from receiving alarms and fault signalling from the module.





To **disable** a module, select it using the function buttons. Once the device has been selected, press the enter button , use the arrow buttons   to select **YES** and then press the enter button  to confirm the disablement.

Modify status – zones

The display shows the first zone by default. To select another zone, use the function buttons.



When a zone is **disabled**, the control unit is prevented from receiving alarms and fault signalling from all the points which belong to the zone.





To disable a zone, select it using the function buttons. Once the zone has been selected press the enter button , use the arrow buttons   to select “YES” and then press the enter button  to confirm the disablement.

System disable

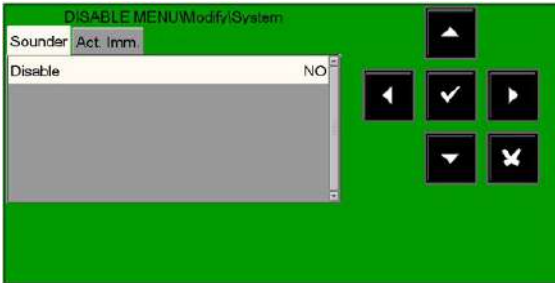
This procedure has three programming folders, where the editing function previously explained is used to enter data.

Sounder exclusion



To change this parameter in this folder, press the enter button  and use the arrow buttons   to select **YES** or **NO**. then press the enter button  to confirm the value.





Excluding immediate activation of siren output

This feature allows the exclusion of the siren output and all the output modules programmed with SW TYPE ID SND. When the exclusion is activated for the immediate activation of the siren outputs, active exclusion and delay LED are turned on.

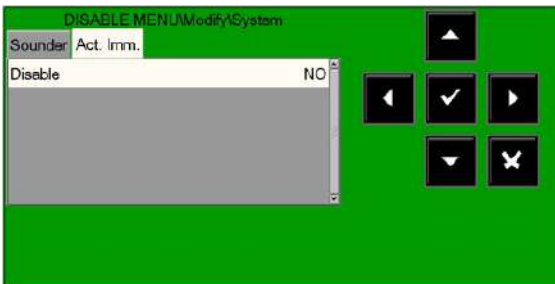
If there is an alarm event, the control panel delays the outputs mentioned for the times programmed in the programming menu (Prog\Sist\Usc. All. Timings).

During delay time, the active LED flashes and you can reset the delay using the delay reset button.



To change this parameter in this folder, press the enter button , and use the arrow buttons   to select **YES** or **NO**, then press the enter button  to confirm the entry.

14 TEST MENU

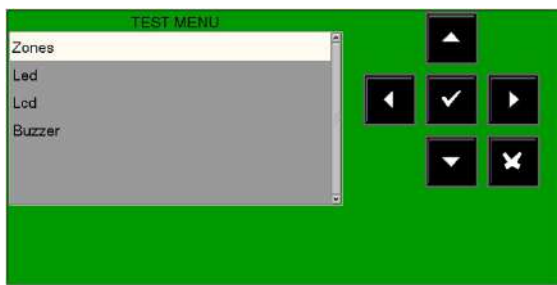

By pressing the **TEST** function button in the main system state display, you can access the test menu, which includes the functions generally used by the servicing personnel to test the system.

To access the menu, enter the **level 2 password** (**22222** is the default password).

To enter the password, refer to the editing function previously mentioned in the paragraph describing keyboard operation to enter data.

This menu is displayed.

Zones

This function allows you to start the walk-test procedure for a selected zone.

This procedure has two folders where the editing function previously explained is used to enter data.

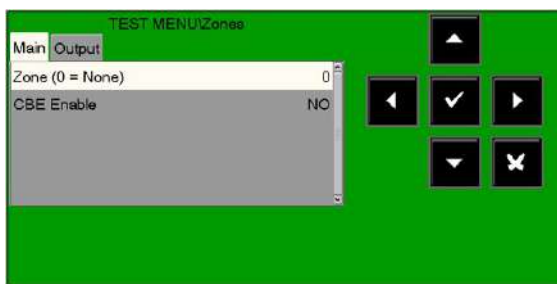

Enabling of a zone for the test function:

Enter the zone number for which the test function needs to be activated. (**0 = test zone OFF**)

CBE enabling

Select CBE Enable: YES

In the event of an alarm from the test zone devices

CBEs associated with them are activated

To change values in this folder, select the parameter using the arrow buttons \uparrow \downarrow (the characters of the selected field are highlighted), press the enter button \checkmark and use the arrow buttons \uparrow \downarrow to change the parameter. When you have finished, press the enter button \checkmark to confirm the entry.

Output selection

The output to be activated in the event of an alarm from a device in the test zone is selected in the subsequent programming folder.

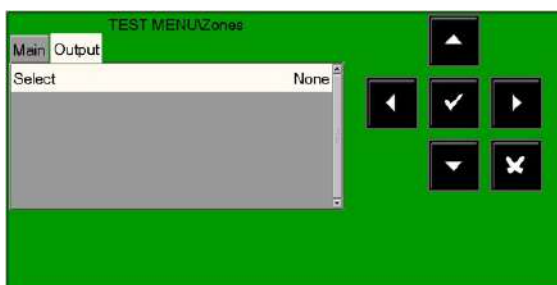

In the "**Select**" field you can select one of the following items:

NONE: in the event of an alarm from the test zone, no outputs are activated.

SOUNDER: in the event of an alarm, both the siren output and all the output modules programmed via SW TYPE ID **HORN** are activated on every alarm event from the test zone. The activation duration is three seconds.

MODULE: in the event of an alarm from the test zone, the output module programmed in the "**Ind. Mod.**" option is activated and on every alarm event it will be active for three seconds.

To change one or more parameters in this folder, select the parameter using the arrow buttons \uparrow \downarrow (the characters of the selected field are highlighted), press the enter button \checkmark and use the arrow buttons \uparrow \downarrow to change the parameter. When you have finished, press the enter button \checkmark to confirm the value.

LED

When the arrow buttons \uparrow \downarrow are used to select the LED option and the enter button \checkmark is pressed to confirm, the control unit performs the lamp-test function (all the control unit LEDs flash for several seconds).

LCD

When the arrow buttons \uparrow \downarrow are used to select the LCD option and the enter button \checkmark is pressed to confirm, the control unit performs the display test.

Buzzer

When the arrow buttons \uparrow \downarrow are used to select the buzzer option and the enter button \checkmark is pressed to confirm, the buzzer will sound intermittently for several seconds.

15 Appendix A – CONTROL-BY-EVENT EQUATION

Control by event concept

Currently there is one formula (direct or reverse depending on the type of point) for each point (sensor/module) of the system.

Typical programming of the control unit is defined as **CONTROL-BY-EVENT EQUATION** (CBE).

During the programming phase, a CBE equation must be associated with each point, zone or group.

The **CONTROL-BY-EVENT** equation allows you to program a series of conditions that the control unit will assess when the point, zone or group is **ACTIVE**, and it will then perform the programmed operations.

To define these conditions, implement the **CBE** equation using logical operators (OR, AND, XGRP, NOT, DEL, SDEL and TIM).

The “**ACTIVE**” condition is valid when:

- Input point (input modules or sensors) = in alarm
- Output point (output module) = ACTIVATED
- Group = one of the points in the group is active

RULES FOR THE CORRECT SYNTAX OF THE EQUATIONS

- To be valid and accepted by the control unit, the control equation must follow some precise syntax rules. If a syntax error occurs, the CBE equation will be rejected.

Logical operators (ex. OR, AND, etc.) that are valid for several operands must be written as follows:
OPERATOR (OPERAND-1 OPERAND-2 ...)

- The NOT logical operator is valid only for one operand and must be written before the corresponding operand.
- If several operators are used, the first character of the equation must be an opening bracket, and the last character must be a closing bracket.

Example: **(OPERATOR (OPERAND-1 OPERAND-2 ...) OPERATOR (OPERAND-1 OPERAND-2 ...))**



A programmable CBE for output modules contains the address of the objects which will activate them, such as: input sensors, input modules or groups. If the module activation needs to occur for a combination of various objects, the AND, OR etc. operators must be used.

A programmable CBE for input sensors and modules contains the address of the objects to be activated in the event of an alarm, which may be output modules or groups. If it is necessary to activate a series of objects, just re-write them in sequence without using any operator.

The following format can also be used:

Example: AND(G1G2)OR(G3AND(G4G5))

Which is equivalent to: 1 - IF BOTH group G1 and group G2 are active

2 - OR

3 - Group G3 is ACTIVE and both group G4 and group G5 are active



The equation must be written without inserting spaces between the characters to be entered.

CBE “null” equation

It is also possible to not program any equation for a device.

In this case:

- If the device is an input sensor or module, the control unit will only activate all general visual and sound signals (alarm LED on the front panel, general alarm RELAY, BUZZER and possible output modules programmed via TYPE ID software for general signalling).
- If the device is an output module it will never be activated unless it is programmed for general signalling via TYPE ID software.



For output modules, the control unit does not allow you to program an equation if the module has a TYPE ID for general signalling.

Refer to **Appendix B: Modules software TYPE ID** at the end of this manual for more details.

Operators used in the control by event equation:

OR

is the operator which requires AT LEAST ONE operand to be ACTIVE.

Example: the output module equation is: **OR (G9 G15 G23)**
The OR operator can be omitted by entering: (G9 G15 G23)

If **ANY** of the three operands in this equation (G9 G15 G23) is in alarm status; the output module will be activated:

- **IF** software group 9 is in alarm status, or
- **IF** software group 15 is in alarm status, or
- **IF** software group 23 is in alarm status
- **THEN** this output module will be activated.

AND

is the operator which requires EACH operand to be ACTIVE.

Example: the output module equation is: **AND (G9 G15 G23)**.

The output module will only be activated if **ALL THREE** operands in this equation are in alarm status, i.e.

- **IF** software group 9 is in alarm status, and
- **IF** software group 15 is in alarm status, and
- **IF** software group 23 is in alarm status
- **THEN** this output module will be activated.

NOT

is the operator which DENIES the operand or the series of operands in brackets.

Example: the equation of an output module is: NOT (G23).

The output module will remain activated until the operand (G23) IS alarmed, that is:

- **If** software group 23 is in alarm status
- **THEN** this output module will be deactivated.



Writing a CBE for a direct group is not permitted if the operands contained inside the brackets are groups with an index lower than the group with which the CBE must be associated, as shown in the following example:

CBE not permitted

~~G33 = (G23 G24)~~

CBE permitted

G21 = (G23 G24)

Writing a CBE for an inverse group is not permitted if the operands contained inside the brackets are groups with an index higher than the group with which the CBE must be associated, as shown in the following example:

CBE not permitted

~~G305 = (G306 G307)~~

CBE permitted

G307 = (G305 G306)

XGRP

is the operator which requires AT LEAST TWO elements of the group indicated below, to be ACTIVE.

FORMAT: XGRP (GXXX) where GXXX= group 1 ÷ 400

Example: the equation of an output module is **XGRP** (G23)

- **IF ANY COMBINATION** of two or more input devices (sensors or modules), which have been programmed (with their CBE equation) in this software group (via **the double consent parameter = YES**) are ACTIVE.
 - **THEN** this output module will be activated.
- **Or** only when a thermal sensor (type ID "THER") and an optical sensor (type ID "PHOT") which have been programmed (via their CBE equation) in this software group (via **the double consent parameter = NO**) are ACTIVE.
 - **THEN** this output module will be activated.

Writing an equation of an output module with several groups is not permitted, as shown in the following example:

CBE not permitted

~~XGRP (G23 G24)~~

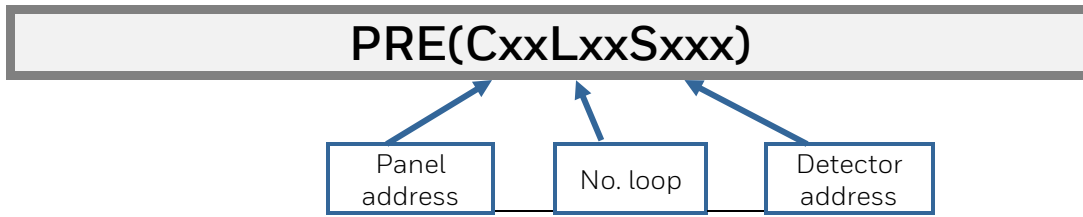

is the operator that uses the pre-alarm status of a sensor.

Example: the equation of an output module is: OR (PRE (C1L1S2) PRE (C2L1S10))

If either of the two sensors (L1S2 of control panel 1 or L1S10 of control panel 2) is in pre-alarm status, the output module with which the CBE is associated is activated.

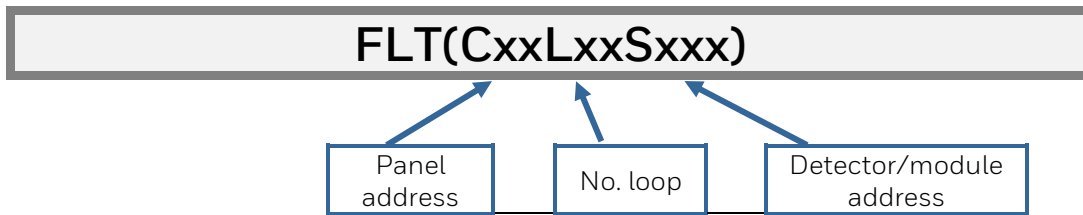

is the operator that lets you use the status of a device or zone failure.

Example 1: the equation of an output module is: OR (FLT (C1L1S2) PRE (C2L1S10))

If either of the two sensors (L1S2 of control panel 1 or L1S10 of control panel 2) is in fault or pre-alarm status, the output module with which the CBE is associated is activated.

Example2: the equation of an output module is: OR (FLT (Z1) FLT (Z2))

If either of the two zones (Z1 or Z2) is faulty, the output module with which the CBE is associated is activated.



is the operator that allows zones and points to be disabled by activating a programmed input module programmed with type-SW "NONA" (does not generate an alarm in the central unit).

Example 1: the equation of an input module is: (DIS (Z1))
When the input module is active, zone 1 is disabled.

Example 2: the equation of an input module is: (DIS C1L1M1))
When the input module is active, the L1M1 module of control panel 1 is disabled.

Additionally, the DIS operator allows you to report a zone or point disabled status by activating the output modules.

Example: the equation of an output module is: (DIS (Z1))
When zone 1 is disabled, the output module is active.

TAC(SYS)

is the operator that allows you to report the silence command performed on the control panel.

Example: an output module equation is: (TAC (SYS))

When the siren silence command is implemented in the control panel, the output module will be activated.

DEL

is the operator which allows you to program activation delays for specific conditions.

If the device has the “DEL” operator in its CBE equation, when its equation is true, it waits for the programmed time before activating.

If, during this delay time, its equation is no longer true, the timer resets and is ready to start for the next event (therefore the output device does not activate).

FORMAT: DEL (MM.SS (delay) MM.SS. (duration - optional) (CONDITION) equation which sets the delay start.
Where:

- MM = minutes (two digits), SS = seconds (two digits)
- CONDITION = it can be an equation of the type:

XGRP (GXXX)

NOT (element 1...)

OR (element 1...element 2...)

AND (element 1...element 2...)

- Element = it can be GXXX for a group (1 ÷ 400) - LXX S/MXX for an addressable point.

Example 1: if the equation of the G90 software group is DEL (00.30 01.30(G21)) then:

Insert a space

- 30 seconds after G21 activation, the G90 group will activate and will be active for 1 minute and 30 seconds.

Example 2: if the equation of the L2M90 output module is DEL (00.30 00.30 (AND (L1S1 L1S4)))

- After the L1S2 and L1S4 sensors have been in alarm condition for 30 seconds, the L2M90 module will be active for 30 seconds.



- If a delay is entered = 00.00, then the equation will be active AS SOON AS the delay start equation is active, and it will be active for the time period specified in “duration”.
- Only one DEL operator can exist for each equation.
- If the DEL equation duration time is not specified, the equation will be active until the elements in the equation are reset.
- The maximum value for the duration is 10 minutes.
- The maximum value for the delay time is 10 minutes.

SDEL

The “SEDEL” operator is equal to the “DEL” operator, with the difference that if the equation is no longer true during the delay time, the timer continues to count and then it activates the output device. An alarm or fault reset must be carried out in order to reset this timer.

TIM

is the operator that allows you to program output activations at periodic time intervals.

There can be two formats:

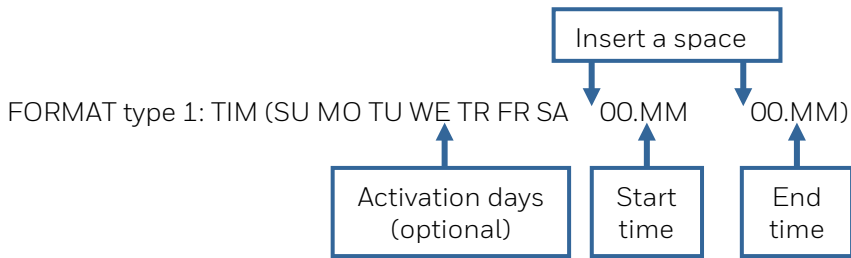

Where: 00 = hours, MM = minutes

This format allows you to create weekly schedules for specific days of the week:

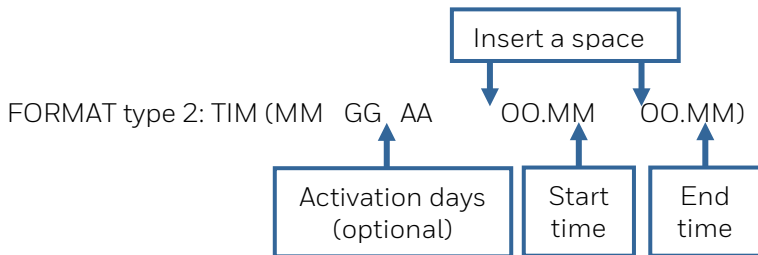

Where: MM = month, GG = day, AA =year

This format allows you to create a yearly schedule

Example:

- **IF** the **G90** software group equation is **TIM (SA SU 07.30 13.59)**
- **THEN** the **G90** group will be active on **Saturday** and **Sunday** from **7:30 am** to **1:59 pm**.



- If the day, month or year are not specified, the equation adopts the meaning of “All days”. To not specify anything, enter two dashes “--”, as in the following example: TIM (-- 07.30 13.59)
- For the start time and end time values, use 24-hour format (midnight = 00:00 ... 23:59)
- The value “00.MM” for the end time **MUST** be higher than the value for the start time.
- The maximum value for start time and end time is 23:59

15.1 Programming examples

OPTIONS

The following example shows three ways to perform simple programming, specifically the output module activation as a response to an alarm on a detector (or any other alarm input device).

OPTION A	OPTION B	OPTION C
Fire detection device LOOP 1 - detector 1	Fire detection device LOOP 1 – detector 1	Fire detection device LOOP 1 - detector 1
Output device LOOP 1 – output module 1	Output device LOOP 1 – output module 1	Output device LOOP 1 – output module 1
Detector equation = (G1)	Detector equation =	Detector equation = (L1M1)
Module equation = (G1)	Module equation = (L1S1)	Module equation =

GENERAL ALARM

The following example shows a method for control unit programming for the general alarm.

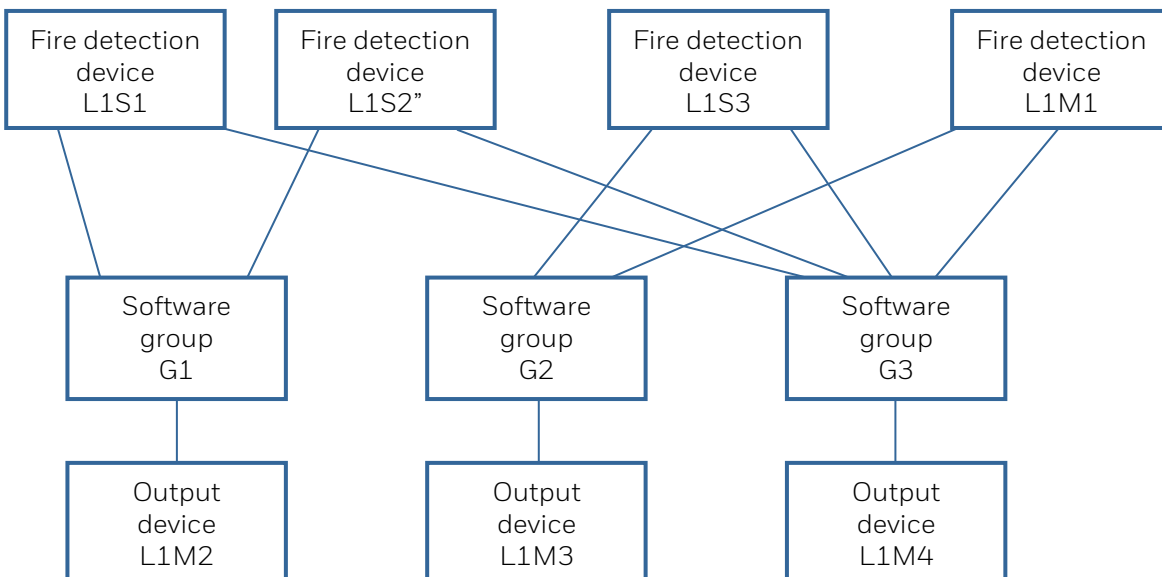

The **L1M2** output module is associated with group **G1** and will be activated in the event of an alarm on the **L1S1** and **L1S2** detectors.

The **L1M3** output module is associated with group **G2** and will be activated in the event of an alarm on the **L1S3** detectors or on the **L1M1** input module.

The **L1M4** output module is used as a general alarm device; it will be activated in the event of an alarm on any fire detection device (detector or input module) in the system, because all fire detection devices are associated with group **G3**.

15.2 Appendix B: Software TYPE ID for MODULES

TABLE-1	Input modules for CONTACTS CLIP	CBE Y/N
MON3	Input module 3 threshold EN54.	Y
MON	Input module 2 threshold (NOT EN 54 compliant).	Y
PULL	Same as MON, but label "MANUAL call point".	Y
NONA	Input module non-alarm.	Y
STAT	Input module same as NONA, signal both status variations.	Y
NCMN	Input module for N.C. contacts.	Y
MTRB	Input module tamper.	N
MACK	Input module for remote ACK (pulse).	N
MTAC	Input module for remote SILENCE (pulse).	N
MRES	Input module for remote RESET (pulse).	N
SCON	Input module conventional zone	Y

TABLE -2A	Output modules supervised CLIP	CBE Y/N
CON	Output module with supervised output.	Y
FORC	Output module relay with potential-free contacts.	Y
PWRC	Output module FORC momentarily interrupts the power supply.	N
GPND	Output module FORC activated on every alarm/fault.	N
APND	Output module FORC activated on every alarm.	N
GAC	Output module FORC activated on every alarm.	N
GAS	Output module CON activated on every alarm.	N
TPND	Output module FORC activated on every fault.	N
GTC	Output module FORC activated on every fault.	N
GTS	Output module CON activated on every fault.	N
TRS	Output module FORC activated on every fault.	N
ZDIS	Output module activated if a point or zone is excluded.	N
REM	Output module FORC can only be controlled by external commands.	N
REMC	Same as REM with supervised output.	N
SND	Output module which follows the status of the panel sounder.	N
GSND	Addressable sounder that can be silenced.	Y
GSTR	Addressable strobe that can be silenced.	Y
STR	Addressable strobe which follows the status of the panel sounder.	N

TABLE -2B	Output modules NOT Supervised CLIP	CBE Y/N
FORC	Output module relay with potential-free contacts.	Y
PWRC	Output module FORC momentarily interrupts the power supply.	N
GPND	Output module FORC activated on every alarm/fault.	N
APND	Output module FORC activated on every alarm.	N
GAC	Output module FORC activated on every alarm.	N
TPND	Output module FORC activated on every fault.	N
GTC	Output module FORC activated on every fault.	N
TRS	Output module FORC activated on every fault.	N
ZDIS	Output module FORC activated if a point or zone is excluded.	N
REM	Output module FORC can only be controlled by external commands.	N
SND	Output module which follows the status of the panel sounder.	N
GSND	Addressable sounder that can be silenced.	Y
GSTR	Addressable strobe that can be silenced.	Y
STR	Addressable strobe which follows the status of the panel sounder.	N

Notes

A large grid of graph paper for taking notes, consisting of 20 columns and 30 rows of small squares.

Notes

A large grid of graph paper for taking notes, consisting of 20 columns and 30 rows of small squares.

Notes

A large grid of graph paper for taking notes, consisting of 20 columns and 30 rows of small squares.

Honeywell
MORLEY IAS Fire Systems
(Pittway Tecnologica, S.r.l.)
Via Caboto, 19/3
34147 Trieste, Italy

M-167.2-SERIE-MA-EN / 11.2021
Technical changes reserved!
© 2021 Honeywell International Inc.

