

## Информационен лист | Номер на артикул: 221-500

Mounting carrier; 221 Series - 4 mm<sup>2</sup>; for DIN-35 rail mounting/screw mounting; orange

[www.wago.com/221-500](http://www.wago.com/221-500)

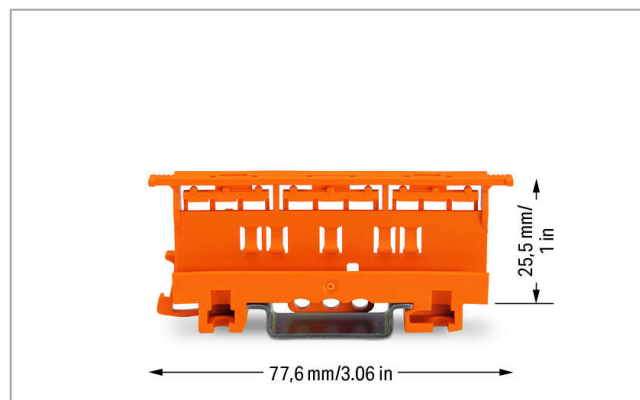
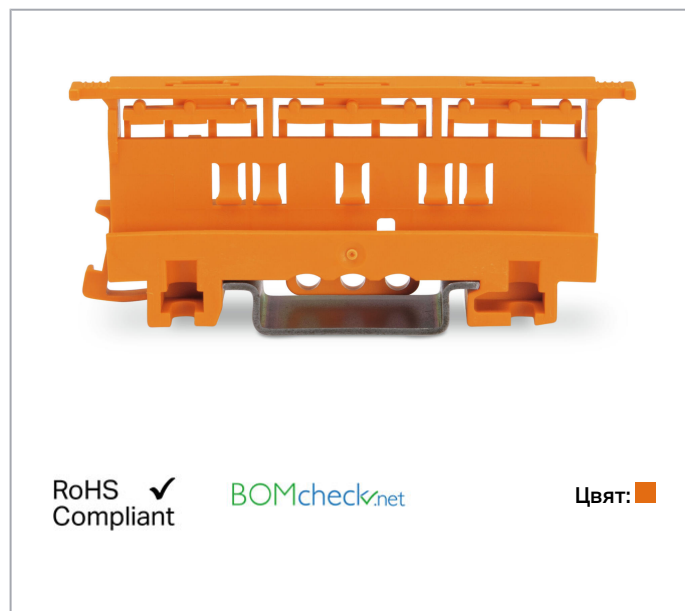

### Данни

#### Physical data

Width	17,5 mm / 0.689 inch
Height from upper-edge of DIN-rail	25,5 mm / 1.004 inch
Depth	77,6 mm / 3.055 inch

#### Mechanical data

Mounting type	DIN-35 rail Screw mount
Suitable	für 2-, 3-, 5-Leiter-Verbindungsklemmen (4 mm <sup>2</sup> ) der Serie 221

#### Material Data

Color	orange
Insulation material	Polyamide (PA66)
Flammability class per UL94	V0
Weight	9,6 g

Подлежи на промяна. Моля, обърнете внимание и на допълнителната документация на продукта!

ВАГО България ООД  
Бизнес център Сердика  
Бул."Акад. Иван Гешов" 2Е | Сграда 1, ет. 4, офис 417 | 1330 София  
Тел.: +359 2 489 46 09 | Тел.: +359 2 489 46 10  
Имейл: [sales.bg@wago.com](mailto:sales.bg@wago.com)

Имате ли въпроси относно нашите продукти?  
Винаги ще се радваме да получим вашето обаждане на +359 2 489 46 09.

## Commercial data

Packaging type	BOX
Country of origin	CN
GTIN	4055143421942
Customs tariff number	39269097900

## Съвместими продукти

### Mounting adapter



Артикул №: 222-505

Strain relief plate; for mounting carrier; 221 or 222 Series, can be snapped

[www.wago.com/222-505](http://www.wago.com/222-505)



Артикул №: 222-510

Angled DIN-rail adapter; in combination with mounting carrier; 221-500 or 222-500; for DIN-35 rail mounting; gray

[www.wago.com/222-510](http://www.wago.com/222-510)

### Marking accessories



Артикул №: 210-833

Marking strips; on reel; 6 mm wide; plain; Self-adhesive; white

[www.wago.com/210-833](http://www.wago.com/210-833)

## Изтегляния

### Documentation

#### Bid Text

221-500 docx - Datei	Jan 23, 2019	docx 14,9 kB	Изтегляне
-------------------------	--------------	-----------------	-----------

221-500 X81 - Datei	Feb 19, 2019	xml 2,8 kB	Изтегляне
------------------------	--------------	---------------	-----------

#### Additional Information

Technical explanations	Apr 3, 2019	pdf 2,2 MB	Изтегляне
------------------------	-------------	---------------	-----------

## CAD/CAE-Data

### CAD data

2D/3D Models 221-500	URL	Изтегляне
----------------------	-----	-----------

### CAE data

EPLAN Data Portal 221-500	URL	Изтегляне
---------------------------	-----	-----------

Подлежи на промяна. Моля, обърнете внимание и на допълнителната документация на продукта!

ВАГО България ООД  
 Бизнес център Сердика  
 Бул."Акад. Иван Гешов" 2Е | Сграда 1, ет. 4, офис 417 | 1330 София  
 Тел.: +359 2 489 46 09 | Тел.: +359 2 489 46 10  
 Имейл: [sales.bg@wago.com](mailto:sales.bg@wago.com)

Имате ли въпроси относно нашите продукти?  
 Винаги ще се радваме да получим вашето обаждане на +359 2 489 46 09.

## Бележки за инсталиране

### Conductor termination

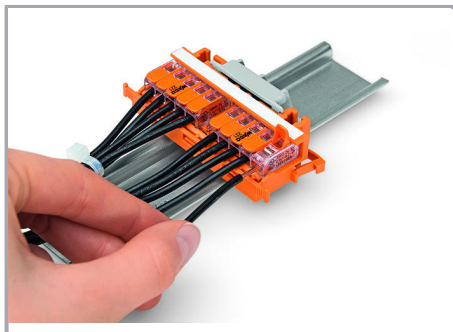

CAGE CLAMP® connection:

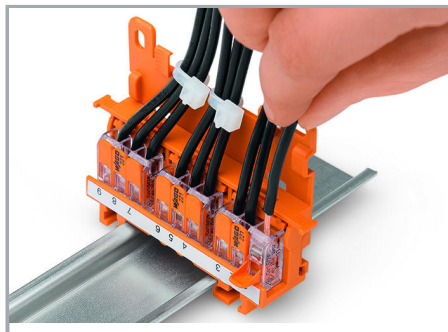

Removing a conductor.

### Conductor termination with connectors fitted in a mounting carrier

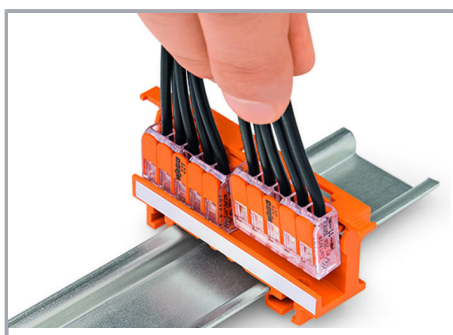

Inserting a connector into the mounting carrier.



Inserting a connector into the mounting carrier.

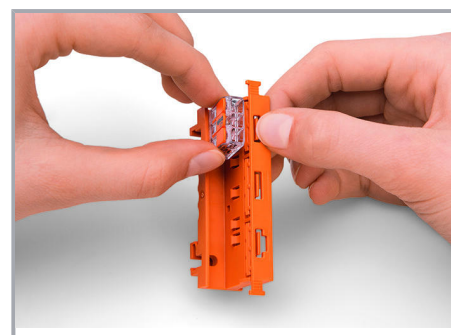

Removing a connector from the mounting carrier.

Подлежи на промяна. Моля, обърнете внимание и на допълнителната документация на продукта!

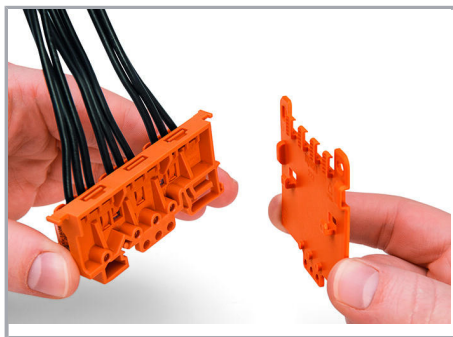

Securing a strain relief plate (222-505) to the mounting carrier.

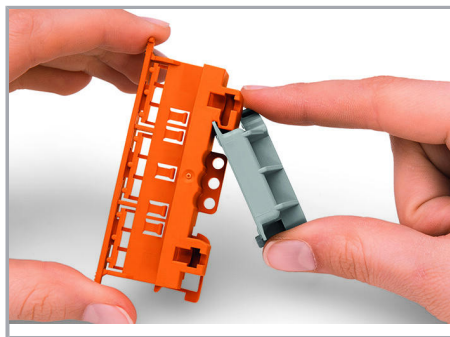

Snapping the angled DIN-rail adapter (222-510) onto the mounting carrier.

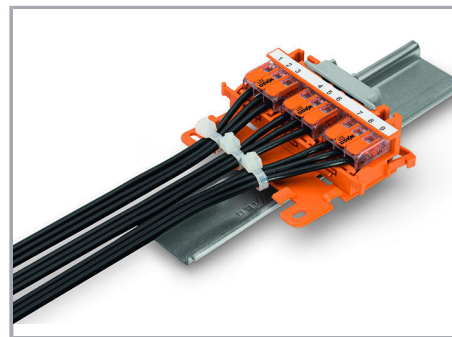

Horizontal mounting on DIN-35 rail using an angled DIN-rail adapter.

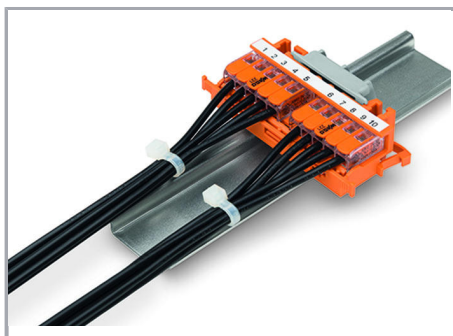

Horizontal mounting on DIN-35 rail using an angled DIN-rail adapter.

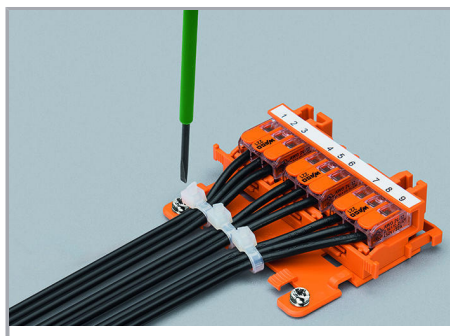

Horizontal screw mounting with strain relief plate on a flat surface

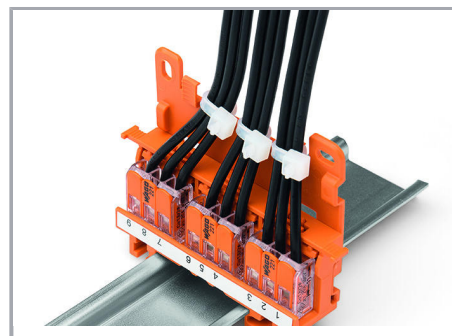

Vertical mounting with strain relief plate on DIN-35 rail.

Подлежи на промяна. Моля, обърнете внимание и на допълнителната документация на продукта!

ВАГО България ООД  
Бизнес център Сердика  
Бул."Акад. Иван Гешов" 2Е | Сграда 1, ет. 4, офис 417 | 1330 София  
Тел.: +359 2 489 46 09 | Тел.: +359 2 489 46 10  
Имейл: [sales.bg@wago.com](mailto:sales.bg@wago.com)

Имате ли въпроси относно нашите продукти?  
Винаги ще се радваме да получим вашето обаждане на +359 2 489 46 09.

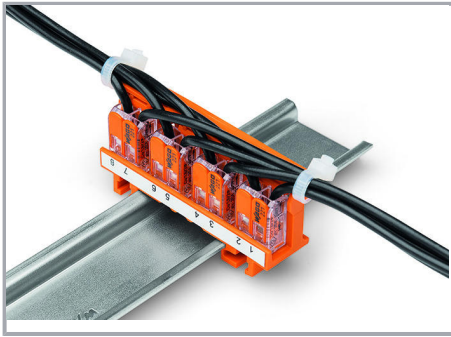

Strain relief via cable ties on the mounting carrier (transverse to the connectors' wiring direction) – clamping units labeled via marking strips (210-334).

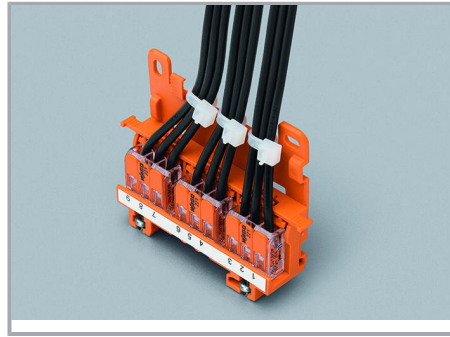

Vertical screw mounting with strain relief plate on a flat surface.

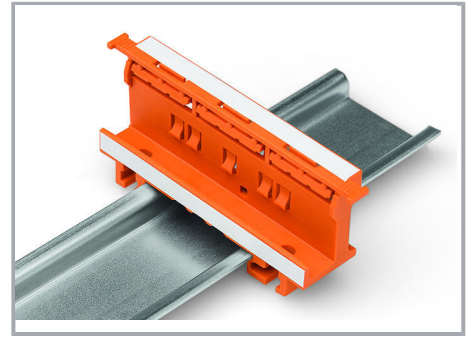

Mounting carrier on a DIN-35 rail

### Testing

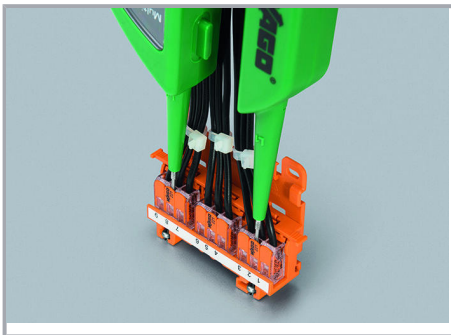

Testing connectors via test slots on top of the carrier.

Подлежи на промяна. Моля, обърнете внимание и на допълнителната документация на продукта!

ВАГО България ООД  
Бизнес център Сердика  
Бул."Акад. Иван Гешов" 2Е | Сграда 1, ет. 4, офис 417 | 1330 София  
Тел.: +359 2 489 46 09 | Тел.: +359 2 489 46 10  
Имейл: [sales.bg@wago.com](mailto:sales.bg@wago.com)

Имате ли въпроси относно нашите продукти?  
Винаги ще се радваме да получим вашето обаждане на +359 2 489 46 09.